



**HAL**  
open science

## Don't Push That Button!

Donato Ricci

► **To cite this version:**

Donato Ricci. Don't Push That Button!. Reset Modernity!, MIT Press, pp.24 - 41, 2016, 9780262034593. hal-01835252

**HAL Id: hal-01835252**

**<https://sciencespo.hal.science/hal-01835252v1>**

Submitted on 22 Oct 2018

**HAL** is a multi-disciplinary open access archive for the deposit and dissemination of scientific research documents, whether they are published or not. The documents may come from teaching and research institutions in France or abroad, or from public or private research centers.

L'archive ouverte pluridisciplinaire **HAL**, est destinée au dépôt et à la diffusion de documents scientifiques de niveau recherche, publiés ou non, émanant des établissements d'enseignement et de recherche français ou étrangers, des laboratoires publics ou privés.

See discussions, stats, and author profiles for this publication at: <https://www.researchgate.net/publication/302266929>

# Don't Push That Button! Reset and Reset Buttons stories

Chapter · April 2016

---

CITATIONS

0

READS

88

**1 author:**



[Donato Ricci](#)

Sciences Po Paris

**30** PUBLICATIONS **73** CITATIONS

SEE PROFILE

# DON'T PUSH THAT BUTTON!

Donato Ricci

24

I DO NOT KNOW if it is still the case, but up until the end of the eighties, in southern Italy youngsters were supposed to spend part of their summer in a craft workshop. My grandfather was a woodworker; so it's normal that I was attempting to learn his art. His voice saying "Arricetta!"<sup>[1]</sup> came as a relief as well as an annoying signal. The work day was over. Or better said, almost over. Before leaving, I had to see to a last, puzzling, duty. Somebody had to deal with all the tools, the screws, the nails, and the jars of glue left on the work benches, as well as all the wood leftovers and the sawdust scattered all around the workshop. Nothing seemed dumber to me. The next day, I started over, the same messiness having arrived again. Among all the tools to take care of, while doing that *nonsense* activity, there was one that I really liked: the marking gauge (see fig. 1). Built by the master himself, the gauge was used to trace thin guidelines on a surface.<sup>[2]</sup> For example, it was used to define the baseline of dovetails serving as a firm registration for placing the chisel. In woodworking, where it is wiser to engrave a reference than to draw it, the physical certainty offered by the gauge makes it a humble but extremely precious tool. In fact, for most objects of woodworking, the consistency among parts is more important than absolute measurements. At the end of the day, it was necessary to put back the gauge rulers carefully, hitting the fixing wedge against a working bench in order

**DONATO RICCI** is design lead and researcher at Sciences Po, assistant professor at the University of Aveiro, and lecturer at Parsons Paris. Focusing on the role of design practices in human and social sciences, he is involved in projects using new visual approaches for observing social phenomena through digital traces. He followed all the design aspects of the AIME project.

to release them. Only at the end of this tedious and long procedure under stern gaze of the master, and after planning the duties for the next day, could I finally go out and play with my friends.

During these very same years, the first video-game consoles started to spread. With a mixture of envy and gratitude, I used to join my friends to play on a Nintendo Entertainment System. Seated on the floor, invisibly fastened to the screen connected to the grey box, we spent hours exploring its mesmerizing 8-bit world. There were no memory slots in the NES, so games had only two possibilities: advancing by winning, or losing. When it came down to losing, you had to start over. Through practice we developed a sort of latent skill consisting in detecting, feeling, and understanding from the very first attempts if it was possible to reach a good point in the game or not. It was an ability that had a single scope: to avoid the frustration of playing in a situation, compromised by the errors committed previously, whose only outcome is going



- 1 The *truschino* (marking gauge), constructed and used in his workshop by master carpenter Donato Ricci Sr. Ca. 1925. Private collection.  
The gauge is composed of a wooden rectangle with two square holes through which two wooden rulers, called *segnatoi*, can slide. The end of each ruler was pierced by a screw the tip of which had been hammered to make it like a small blade. Between the holes for the rulers there was a third hole or slot in which a trapezoid fixing wedge was lodged to keep the rulers in the desired position.

back to the starting screen. One way to mitigate this was to rely on one of the two buttons jutting out of the plastic box: the reset (see figs. 2a and b). Hitting that button resulted in a short TV flicker, the game reloading, the mistake gone.<sup>[3]</sup> At that point, before we started playing again, a kind of huddle was expected to debrief what happened while playing, hoping to have gained a little bit more experience to finish the game.

### BOXING UP

I'M JUST REALIZING now how these two apparently very different moments of my youth – probably an evident manifestation of what Baudrillard defined as “the great shift from a universal gestural system of labour to a universal gestural system of control” (49) – were indeed two different instances of the same procedure: the reset procedure. Starting with the identification of a moment of rupture: in one case the end of the work day; in the other the

feeling of having no chances of success. A procedure that goes on with a sequence of actions: rearranging the space of the workshop in one case; redefining the environment of the room, in the other. A procedure that finds a focus: on the one hand, the wedge of the marking gauge that has to be hit; the reset button to be pressed, on the other. A procedure that finishes with a reflexive moment: planning the next work day in the workshop, and defining moves for the next game. After this set of gestures everything is set for a fresh start. It is really quite different from a new beginning. Again the experience is still there, I was starting afresh but I was not, in both cases, becoming a newbie again. Thank God!

And yet, usually, when we evoke a reset across this long procedure through harsh metonymic simplification, what we have in mind is a big red button. The trigger has become the procedure itself.<sup>[4]</sup> It could be seen as ratification of the button's primacy, the transformation of the entire procedure in a dyadic, symbolic stimulus-response negotiation. The

[1] The imperative can be translated from the Neapolitan language as: “Put in order! Reset!”

[2] Called *truschino* in Italian.

[3] That was not the only function of the button; in the same situation it could be used for cheating (Consalvo, Altice), till the point that Nintendo, in a game for the Game Cube, *Animal Crossing*, avoided the gamers profiting by inventing a special character: Mr. Resetti.

[4] This can be easily tested by a quick and dirty method. Try to use an image search engine and query for “reset.” By using the keyboard combination `CTRL -` set the browser zoom to the minimum, reload the page, and a huge repertoire of more or less skeuomorphic buttons will appear. Don't forget to reset your zoom after that, a specific button should appear when using the combination `CTRL +`.

1. NES COMPONENTS

• CONTROL DECK

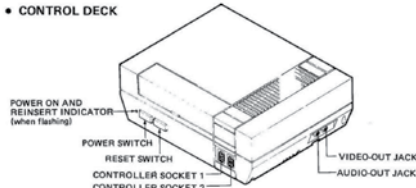

• REAR VIEW OF CONTROL DECK

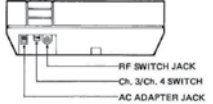

• CONTROLLER

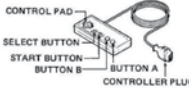

• AC ADAPTER



• 75/300Ω CONVERTER



• 300/75Ω CONVERTER



• AUDIO/VIDEO CABLE



• RF SWITCH

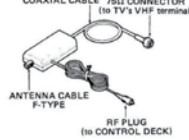

26

2a Page 2 of the Nintendo NES user manual Control Deck: The Control Deck That Puts You In Control of Incredible Fun! Redmond: Nintendo of America, Inc., 1988. PDF file.

2b Detail of the Nintendo NES electronic schematic, with reset switch in the bottom right corner. Schematic Diagrams for Nintendo Entertainment System. Electronic Corp., 1992. Web.

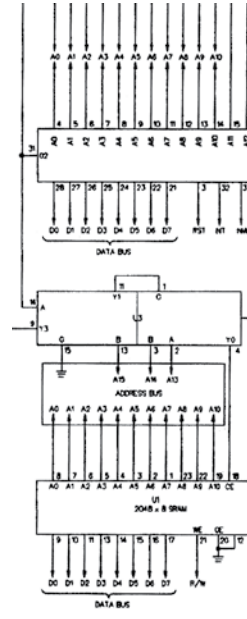

button alienated from its procedure, and the procedure black-boxed into the button itself, are producing an immediate magic effect, leading from a cause to an effect by a short circuit. The button, thanks to its binary nature, represents, when not activated, an existing state, and when depressed a change in the future of the state. Like any magic object it deserves respect, and we are supposed to use it in case of a firm will of change, placing in it our hopes.

Take, for example, its use in movies (see figs. 3a-c) [5] during different periods. Associated first with craftsmanship practices, then in relation to mechanical and measuring instruments, it becomes part of a discourse on electronics and control, to be, then, tightly connected to the button. The rise of the co-occurrence reset + button can be

observed much later on the adoption of consoles in the domestic panorama. How weird is it that this relationship has been consolidated in the era of the disappearance of physical buttons. Buttons are increasingly replaced by a mimicked instance on a flat touch screen, and where the reset button, if not replaced by an awkward simultaneous pressure on a combination of buttons, or regressed into the back of the electronic device, quite often activates by inserting a pin into a small hole. Of the original procedure, in our symbolic panorama, only the magic of a stereotypical, mysterious yet reassuring object remains. An object able to instantaneously wipe clean any error, and able to reinstall, in the thick of any situation, order and homogeneity to any current state.

[5] The visualizations (see figs. 3b and c) are based on the movie subtitle containing the word “reset.” They have been retrieved via movies.benschmidt.org and quodb.com. Two sentences before and two sentences after the one containing the word “reset” have been considered as a dialog and retained to compose the final dataset to be analyzed. The main keywords used in a dialog have been extracted manually, by reading the texts and by using a text-mining module, Pattern (clips.ua.ac.be/pattern). The co-occurrence network has been produced by linking together the keywords appearing in the same dialog.

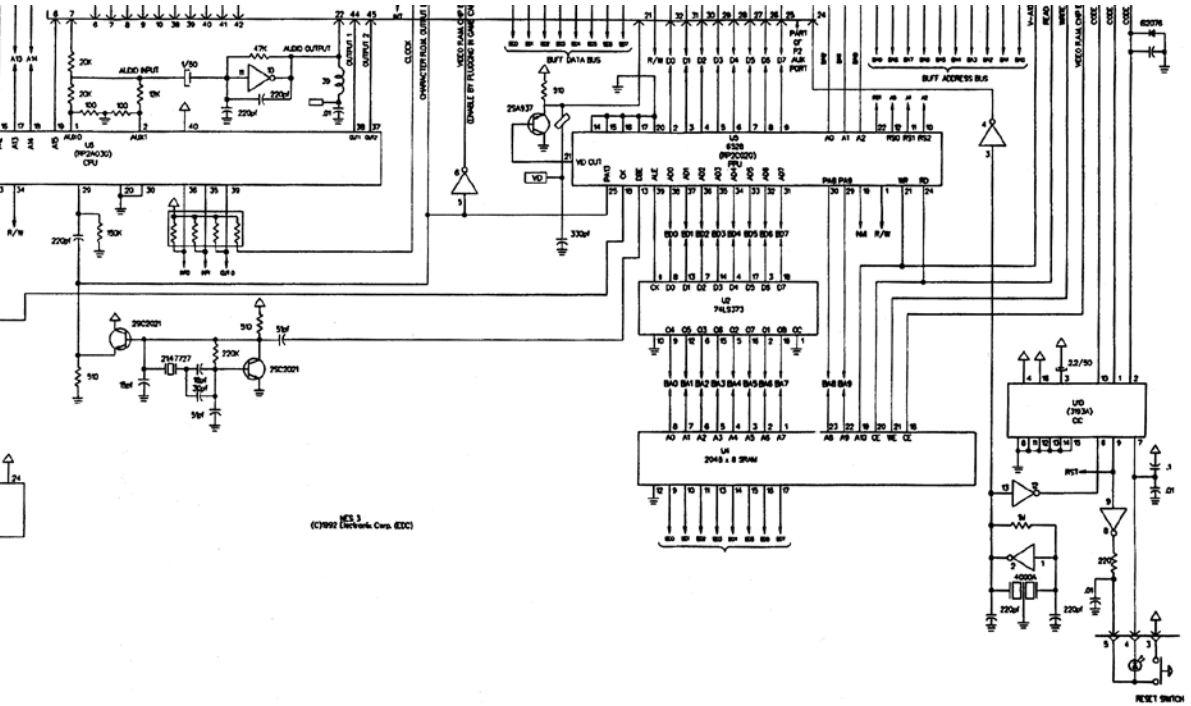

- 1 - BOOKS.GOOGLE.COM/NGRAMS
- 2 - OPENSUBTITLES.ORG
- 3 - OPENLIBRARY.ORG
- 4 - CHRONICLE.NYTLABS.COM
- 5 - HATHITRUST.ORG

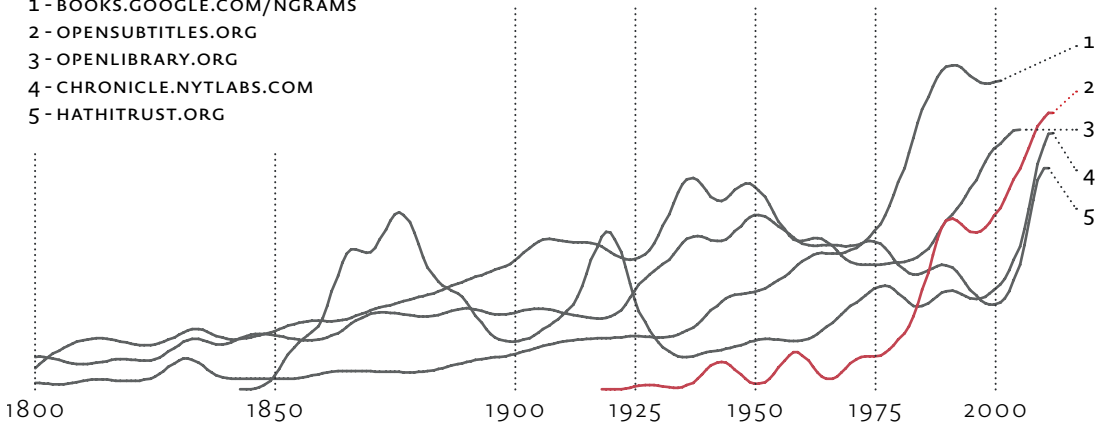

3a Occurrence of the term “reset” between 1800 and 2015, according to various text datasets (containing digitized books, newspapers, and movie subtitles). The apparent peak around 1850 is due to errors during the OCR conversion (for instance, the misinterpretation of the word “refer” as “reset”), while the peak around 1925 is related to the practice of publishing court judgments in newspapers, which for example referred to thief trials.

# QUOTES

## THE DIVORCEE

- 1930 -

- I had it **RESET** for you.
- Oh, it's lovely, darling.
- You like it?
- It's to keep your **WEDDING RING** company.

## THE DEVIL COMMANDS

- 1941 -

- RESET THE GRAPH**, please, Richard.
- See how different the wavelengths are?
- Why should this record be so much stronger?

## ONLY THE VALIANT

- 1951 -

- If I can **RESET THESE FUSES**, this mission may still be a success.
- Judging from the ruckus I hear out there, our red brothers are too busy at the moment.

# GENRES



FREQUENCY CLASS PER DECADE



HIGH MED LOW

# KEY WORDS

DIAMOND



RING



PAGE



TEXT



BANK



GANG



JEWELER



THEFT



GRAPH



CLOCKS



WAVELENGTHS



RECORD



FREQUENCY CLASS PER DECADE



HIGH MED LOW

SHIPS



FUSES



YARD



GALLANTS



ORDERS



PLATINS



WHISTLE



WIND



ABSOLUTE tf

NORMALIZED tf

## QUOTES

### THE DAY THE EARTH CAUGHT FIRE

— 1961 —

-Slip edition in five minutes. **FRONT PAGE NEEDS RESET.**

-What's the betting some princess is pregnant again?

### SULT

— 1966 —

-It's ten!

-It's two!

-You're wrong, it's ten! You'd better **RESET YOUR WATCH**, my good man!

### STAR WARS EP. V

— 1980 —

-He's all yours, bounty hunter.

-**RESET THE CHAMBER** for Skywalker.

-Skywalker has just landed, lord.

-Good. See to it that he finds his way in here.

## GENRES

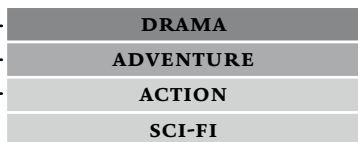

## KEY WORDS

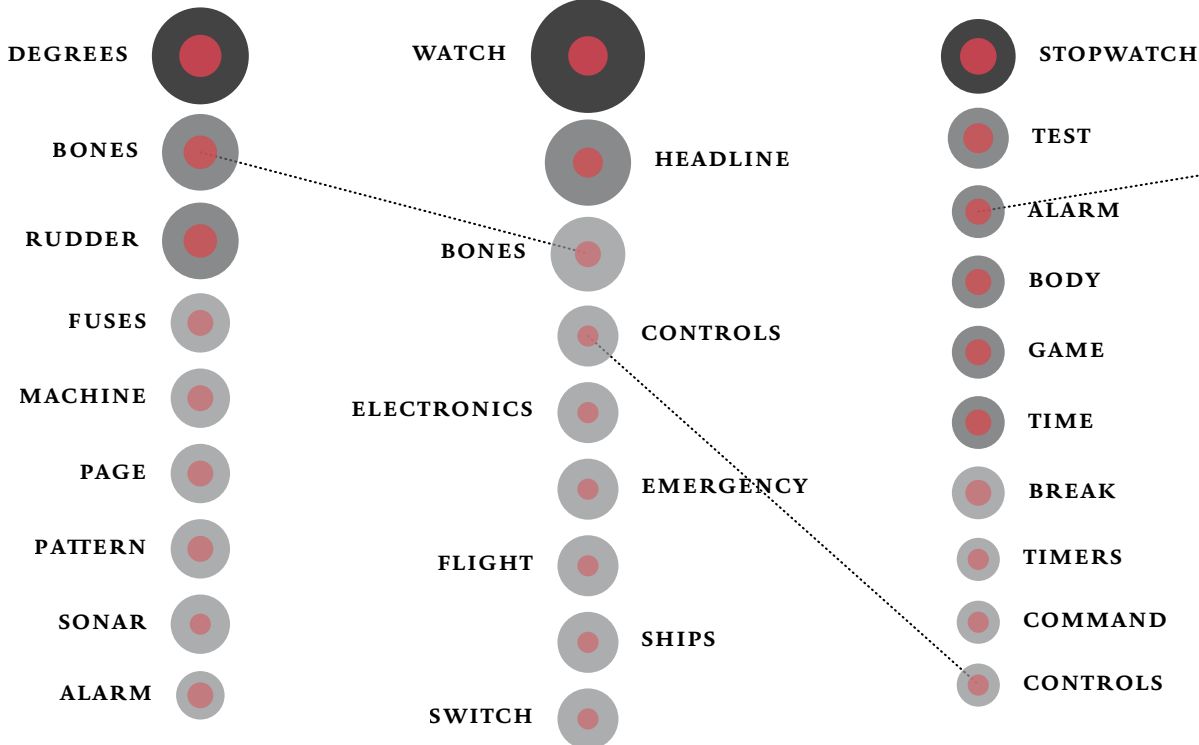



# QUOTES

## APOLLO 13

- 1995 -

- We've got a **COMPUTER** restart.
- We've got a ping light.
- The way these are firing doesn't make sense. We've got multiple caution and warning, Houston. We've got to **RESET** and restart.

## NO MAPS FOR THESE TERRITORIES

- 2000 -

- Functional nanotech would pretty much guarantee both of those because there would be, you know, no reason to die if you had sufficient nanotech to keep **RESETTING THE LITTLE CELLULAR CLOCKS**.

## LIVE FREE OR DIE HARD

- 2007 -

- Just hit the **RESET BUTTON** and melt the system just for fun.
- Hey, it's not a system. It's a country. You're talkin' about people, a whole country full of people, sitting at home alone, scared to death in their houses, all right?

# GENRES

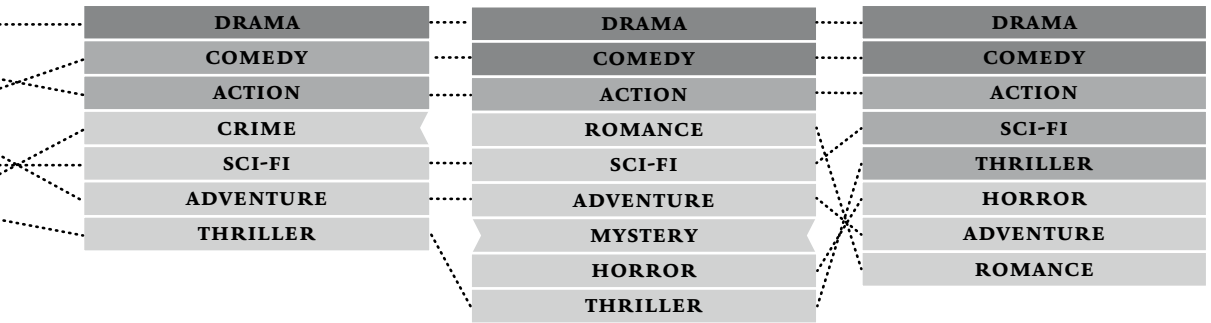

# KEY WORDS

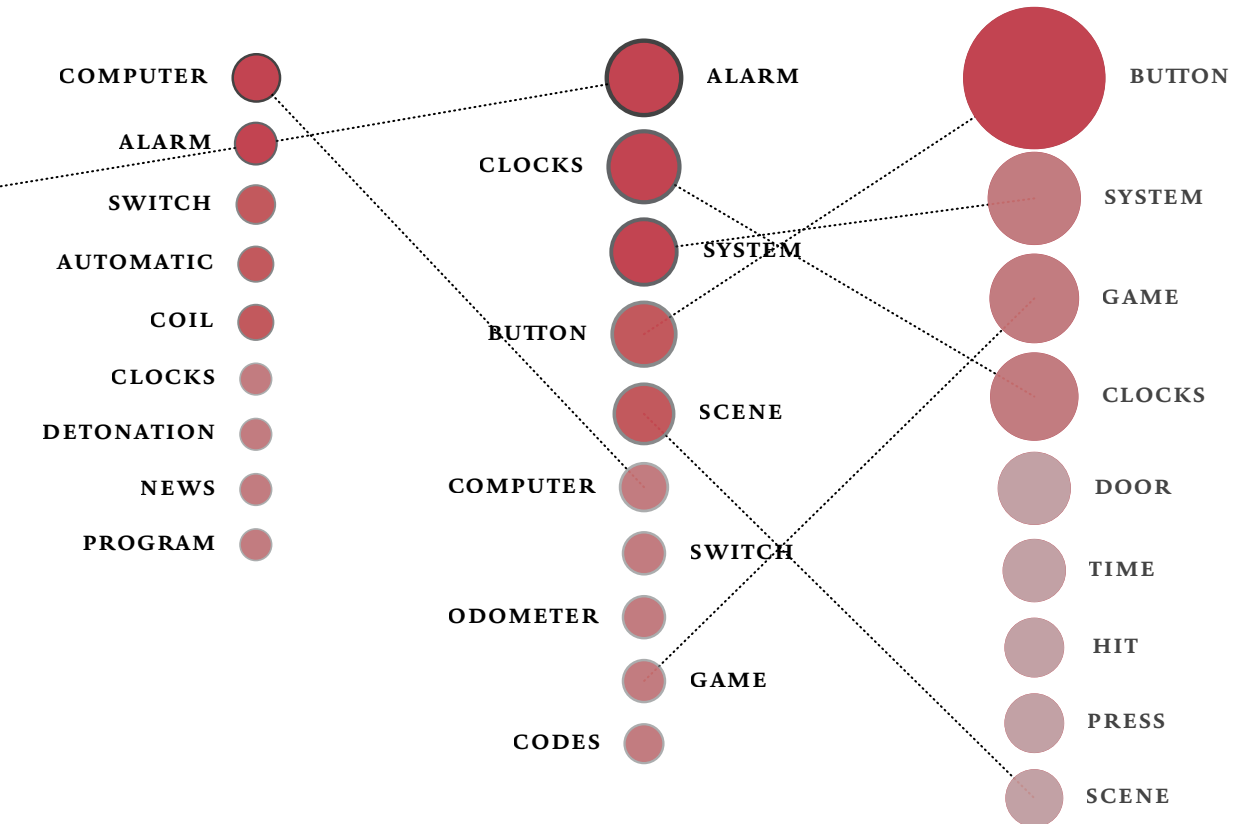



## PREPARING A COMPOSITION

IF WE LOOK BACK at the origins of the term “reset” we can rediscover a sense of composition as an active process of selection, adjustment, and transformation done by the grouping and the reconnection of heterogeneous items. By doing a reset, a certain space is carefully prepared to host an event, an action, again. Indeed, etymologically the term is composed of *re* (again, back, anew) and *set*. If we retrace *set* to its Germanic root, it expresses the idea of putting something in place, to fix, to adjust, to group again. Additionally, if we go back to its Latin origin, *cipere* (as an alteration of *capere*), *set* defines the action of taking,<sup>[6]</sup> hosting, accommodating, and recovering. In this sense, it is also semantically linked to *receipt* and *recipe*, as to devise a series of steps, actions or ingredients of a preparation.

The act of composing is expressed in all its delicacy and importance, in pre-digital typographic practices – in an age when the composing of the pages of a book was extremely labor intensive – aimed at fitting “physically and visually in various combinations” (Drucker and McVarish 80) letterform, graphic ornaments, and images. If a text was reset, for instance, by changing the number of words per line, bibliographers reconstruct the genesis of the texts listing clearly all the changes made as compared with the previous edition. It is a kind of alert for the readers, a warning about possible alterations to the meaning and the sense of the text that may have been introduced by changes to its appearance (see fig. 5). It is with the evolution of mechanics that the term starts to indicate an automatism (see figs. 6a and b), which leads to a terminological

confusion. For instance, in fig. 7 the button used to clear or wipe a wrong combination is called reset.<sup>[7]</sup> Although the button is part of the procedure to prepare the system’s welcoming of a new combination, its main feature is to erase the user’s error. Indeed, a real reset procedure is the one offered by many padlocks (see figs. 9a and b), and in general all procedures used to change the authentication of a system are a really good demonstration of how the reset is a long chain of mediation between heterogeneous entities. Whether it is changed through a help desk or by using a self-service application, the user is called upon to run a long script whereby she has to be attentive and patient: to establish that she is human, by completing a CAPTCHA; to provide a proof that she is the real owner of the service for which the new password is required; to compose a PIN sent by e-mail or instant messaging to obtain a one-time password token; and, eventually, choose a new code. The longest 15 minutes of your life if you are trying to reset the password of a hijacked account of yours!

## INSTRUCTING A MEASUREMENT

RESET PROCEDURES are more often than not nested in other procedures,<sup>[8]</sup> but they are of primary importance in scientific observation and measurements (see figs. 10, 11, and 12). Before recording any measurement, thermometers, microscopes, telescopes, sextants, and spirometers have to be calibrated to a baseline through a reset procedure. Among all the recording devices that created an “abstract framework of divided time that became more and more the point of reference for both action and

[6] In this sense the word *reset* is used to designate the receiving of stolen goods (see fig. 4).

[7] There was the same sort of confusion until some years ago with regard to online forms, when to discarding any information entered in them, the user was supposed to use a button labelled *reset*, rather than *clear*. A similar semantic overlap appears in the NASA Space Shuttle manual (see fig. 8). The button *MSG RESET* “clears ... the ... fault ... Depressing this key will also extinguish all software-driven caution and warning annunciators. ... An *ILLEGAL ENTRY* message can only be cleared with the *MSG RESET* key”; while *I/O RESET* “attempts to restore a GPC’s [General Purpose Computers] input/output configuration to its original status prior to any error detection” (2.6–34).

[8] Simple examples are procedures for winemaking or sailing routines.

4 Extract of page 413 from: Robert Pitcairn. *Criminal Trials in Scotland* [...]. 3 vols. Edinburgh, 1833. PDF file.

**Common Theft and reset of Theft.**  
 'WILL ELLOT, callit *W'oddir-nek*; Petir Trunbill, callit *pe Monk*;' and Henrye Blak, in Softlaw, Convict to be ILANGIT for Commoun Thift and Commoun reslett pairof.'

8. **An Essay on Man. In Epistles to a Friend. Epistle II.** London: Printed for J. Wilford, at the Three Flower-de-Luces, behind the Chapter-house, St. Paul's. (Price One Shilling). Folio, uncut, bound with No. 6.

\*This is the second edition, with the same collation as the first but entirely reset, with different ornaments. Pp. 13 and 14 of this edition contain 22 instead of 20 lines. This error is corrected on pp. 15 and 16. Otherwise the two editions are page for page. The most notable difference in the two editions is that in this second edition the lines are unnumbered. They are numbered in the earlier edition, though lines 250-270 are mis-numbered 150-170. One copy of this edition is known in which line 175 is numbered. This is sufficient proof that the edition with numbered lines is the first.

5 Extract of page 7 from: Marshall Clifford Lefferts. *Alexander Pope: Notes towards a Bibliography of Early Editions of His Writings* [...]. Cedar Rapids: The Torch Press, 1910. Web.

6a Patent announcement for William Biddle's "Trap for Catching Animals." *Journal of the Franklin Institute* 26 (1840):111. Web.

26. **For Traps for Catching Animals; William Biddle, Pittsburgh, Pennsylvania, July 12.**

This trap is constructed in a manner bearing considerable resemblance to that patented by Thomas Kell, on the 3rd of March, 1838, and the ends proposed are the same, namely, that the trap, after catching an animal, shall reset itself, or be reset by the animal; that the captured animal may pass along a passage leading to a separate compartment, from which it cannot return, said compartment being so constructed as to be readily detached from the body of the trap. The particular devices, of course, differ from those used in the trap above named, or the present patent would not have been granted. The claims are confined to these particular devices, as referred to by letters on the drawings.

6b William Biddle. "Cage Trap." Patent drawing. US Patent 1238, issued 12 July 1839. Web.

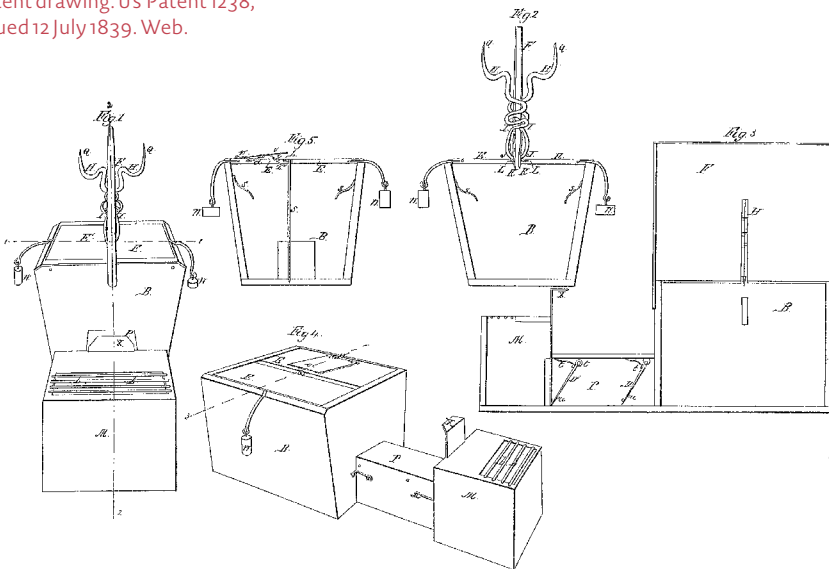

Patented July 12, 1839.  
 Cage Trap,  
 W. Biddle,  
 2 Sheet, Sheet 1.  
 J<sup>y</sup> 12, 1838.

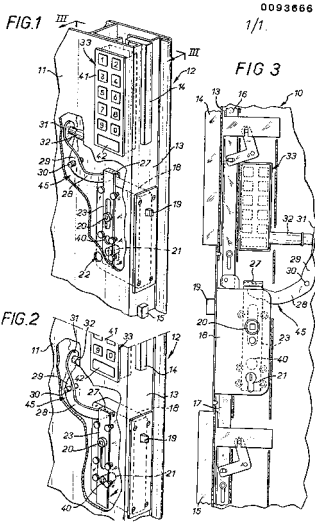

SINGLE KEYSTROKE COMMANDS			
FAULT SUMM	SYS SUMM	MSG RESET	ACK
GPC/ CRT	A	B	C
1/O RESET	D	E	F
ITEM	1	2	3
EXEC	4	5	6
OPS	7	8	9
SPEC	-	0	+
RESUME	CLEAR	•	PRO

MULTI-STROKE INITIATORS. REQUIRE EXEC AS TERMINATOR.  
 TERMINATOR FOR ABOVE INITIATORS.  
 MULTI-STROKE INITIATORS. REQUIRE PRO AS TERMINATOR.  
 SINGLE KEYSTROKE COMMANDS      TERMINATOR FOR OPS AND SPEC

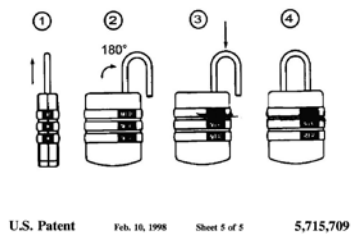

U.S. Patent Feb. 10, 1998 Sheet 5 of 5 5,715,709

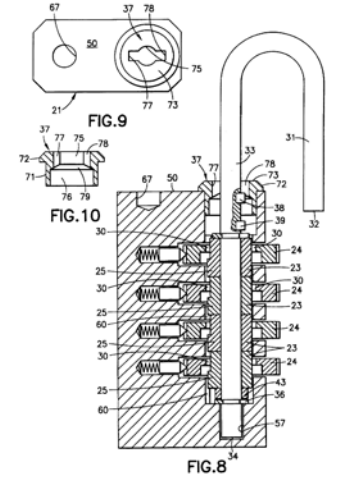

Multifunction Electronic Display System Keyboard Unit on Panels C2 and R11L

34

7 Henri Rochman. "Protective device for key-operated door locks." Patent drawing. EP Patent 0093666, filed 28 Apr. 1983, and issued 9 Nov. 1983. Web.

8 Table from page 2.6–34 in: NASA. Shuttle Crew Operations Manual. United Space Alliance, LLC, 15 Dec. 2008. Web.

108 MECHANICS.

should be taken not to set it too far out, as, by so doing, the clew would be lowered, the strain of the sheet fall too much on the foot, and one night, with a strong breeze, might considerably injure the standing of the sail.

No. IV.

REPEATING STOP FOR A SEXTANT.

The GOLD IBIS MEDAL was this Session presented to Mr. T. REYNOLDS, 13, Arbour Terrace, Commercial Road, for a Repeating Stop for a Naval Sextant, which has been placed in the Society's Repository.

In the sextant, as ordinarily constructed, an observation or angular measurement being made, must be read off and registered before the instrument can be used for a second observation. The only inconvenience attending this, in day observations, is the interval which it necessarily makes between two successive observations. But during this interval clouds may interpose to prevent a second observation; and in all cases where the mean of several successive ones is wanted, the shorter the interval that occurs between them, the more are they to be relied on. In night observations the advantages of expedition are still greater than by day, because the interval between two successive ones is necessarily much lengthened by being obliged to go to a light on deck, or, it may be, in the cabin, in order to read off the result. It is also found, that when the eye is brought from almost

109 MECHANICS.

darkness into a bright light, a certain time is required for that organ to adjust itself before the sight becomes sufficiently distinct to perceive minute objects, and consequently to make an observation and read off its result with the necessary correctness. By means of Mr. Reynolds's repeating stop, which, at a small expense, may be applied to any instrument now in use, five observations may be made in succession without the necessity of reading off, because the bolts in the repeating stop will register the first four, and the index of the instrument will register the last as usual. The only thing, therefore, required for the observer to be aware of, is, that the results of the observations are read off in an order precisely the reverse of that in which they were made.

The invention has received the approbation of the Admiralty, of Mr. Lamont of the Greenock Observatory, of Mr. Lynn, and of Commander Low, R.N., whose testimonials are hereto subjoined, as well as of many professional men, who are at present using it.

Hydrographical Office, Admiralty,  
September 21, 1827.

SIR,

I am directed by Sir George Cockburn to acquaint you, that you are at liberty to make use of the approbation of the Admiralty for your invention, agreeable to the request you made.

In addition, from myself, I sincerely wish you success in disposing of it, for, though simple, I think it will be of great use to navigators.

I am, Sir, &c. &c.  
Mr. REYNOLDS. J. WALKER.

9 Example of key resetting in a lock. Eric Lai. "Combination Lock Construction." Patent drawing. us Patent 5715709, filed 11 Jan. 1996, and issued 10 Feb. 1998. Web.

10 J. Walker et al. "Repeating Stop for a Sextant." Transactions of the Society of Arts Manufactures and Commerce 47 (1829):108–11. Web.

caliper legs, but this is not readily done as a makeshift. To measure the inside diameter of a bore having a shoulder like the piece *H*, the inside caliper *F* may also be set as usual and then a line marked with a sharp scriber on one leg, by drawing it along the side *G*. Then the legs are closed to remove the caliper, and are reset to the scribed line. Of course, this method is not as accurate as the previous one, and can be used only for approximate measurements.

To get the thickness of a wall beyond a shoulder, as at *K*, Fig. 7, set the caliper so that the legs will pass over the shoulder freely, and

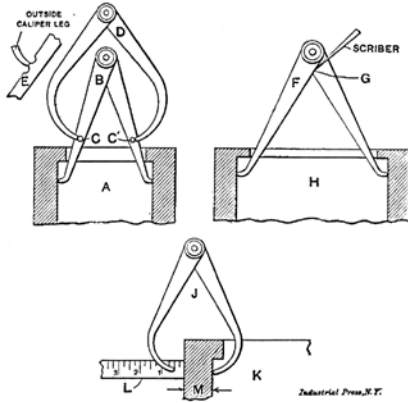

Fig. 7. Methods of Inside Caliperling

with a scale measure the distance between the outside leg and the outside of the piece. Then remove the caliper and measure the distance between the caliper points. The difference between these two distances will be the thickness *M*.

11 Page 14 from Machinery's Reference Book 21: Measuring Tools. New York: The Industrial Press, 1910. Web.

**Cyrtometers.**

These usually consist of some form of curved caliper provided with flexible arms by which the shape of the outer chest wall may be ascertained and transferred to paper.

**Flint's Cyrtometer**, as shown by figure 45, consists of a caliper with short steel arms to the ends of which strips of bar lead are attached by means of set screws. These soft, pliable parts form the contact portion of the instrument. A curved bar, or indicator, attached to one arm rests in and slides through a slot in the opposite arm. A thumb screw fixes the arms at any degree of separation. The cross bar is graduated so it can be reset at any given position. By fixing the instrument at the proper width, the outline of one side of the chest may be accurately molded in the lead bars, the set screw released and the instrument removed, after which by replac-

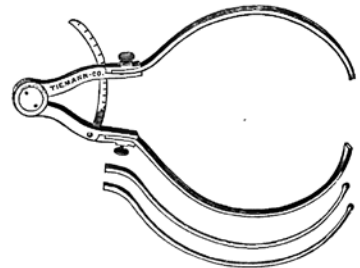

Figure 45. Flint's Cyrtometer.

12 Extract and table from pages 46 and 47 in: Charles Truax. The Mechanics of Surgery. San Francisco, 1899. Web.

13 Bert Chapman. "Clock Resetting Device." Patent drawing. us Patent 1830750, filed 14 May 1927, and issued 10 Nov. 1931. Web. 24 Feb 2016.

Nov. 10, 1931.

B. CHAPMAN

1,830,750

CLOCK RESETTING DEVICE

Filed May 14, 1927

2 Sheets-Sheet 1

Fig. 1.

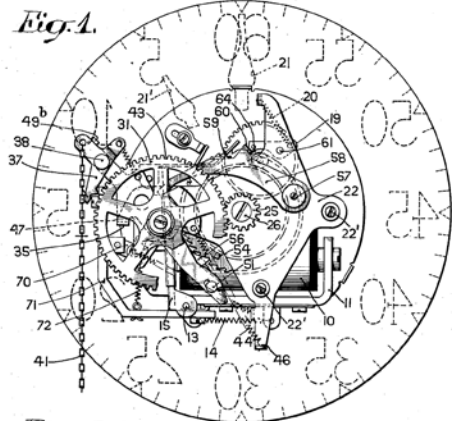

Fig. 2.

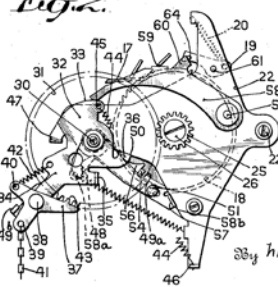
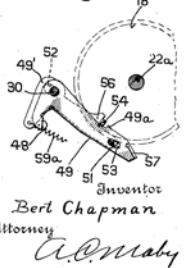

Fig. 3.



thought” (Mumford 16), clocks and timers (see fig. 13) are the ones most commonly associated with the reset. The relevance of a technology, in this case the one enabling the precise measurement of time with cogs and wheels, is reflected in the introduction of a series of new metaphors and analogies: “When the mechanical clock arrived, people began thinking of their brains as operating ‘like clockwork’” (Carr). Although, we do not have to bother ourselves anymore with resetting our clocks when travelling from one time zone to another – a *daemon*, a *pacemaker*, an invisible script<sup>[9]</sup> will do it for us by connecting the device to a remote server – we still have to reset our biological clock, our circadian rhythm, the phase of our neurons (see figs. 14 and 15). In this way, thanks to an analogical extension, if the mind and the body are clockwork, the way to control them, quickly, is the reset. Reset, in this case, is the recipe, a magic walkthrough. Query Amazon for reset (see fig. 16): a wall of front pages, where more often than not a big reddish button stands prominently, promising in 7, 14, or 21 days to reset our metabolism, our karma, our motivations or our inspirations, cleanse our body and our mind of stress and toxins. Once again we are witnessing the promise and the premise of a dream, a long procedure becoming a click; a button offering, without any mediators or dispatchers, to erase any lifestyle misconduct, a button equipped with an effective binary logic to disclose an “after” erasing all the errors of “before,” with a comfortable action of the finger.

## ITERATING A CALCULATION

IT SHOULD COME AS NO SURPRISE that among the book categories most related to the reset there is religion. A book of sermons depicting the Great Flood as the principal scene of all the resets: God inflicting a merciful punishment for a new beginning of the human race. Fictional-religious-dystopic-apocalyptic books depict doomsday as major resets. Close to these gods are other ones, the theo-computational (Bogost) ones, promising stability and perfection, in which, again, the metonymic confusion lets the reset be a button and a clear.

Reset and clears are quintessential in computation. In positional algebraic<sup>[10]</sup> devices, such as the abacus or the suan pan, to reiterate a calculus as an act of reset was performed by manually sliding the beads along the wires, replacing the swipe and erase gesture of the dust abacus, in other words replacing its blank-state concept. Pascal’s machine and Babbage’s one (see fig. 19) required massive human intervention to complete calculation cycles (Essinger): annotating the results, moving the drums, gears, and cams to reset them to zero in order to perform a new calculation. Again a long mediation process is visible. The subsequent evolution of calculating machines using electromechanical relays, the flip-flop<sup>[11]</sup> (see fig. 20), was probably crucial in producing the idea of the reset as an immediate and nonmediated action, recalling the idea of a *tabula rasa*. Although the ENIAC (see fig. 18) – the first completely programmable Turing machine, a giant of 30 tons wired by

- [9] In technical environments, transport systems, or spacecraft a similar operation is performed by Watchdog Timer, Command Loss Timers. These are daemons controlling the state of computers checking, not for the correct timing, but for their correct refresh, generating, in case, timeout signals to start a reset and recovery procedure. They are a kind of automatic Dead Man’s Switches.
- [10] In an infinite game of lexical and etymological links, it is worth remembering that the word “algebra” derives from the Arabic *al-jabr* or *jābara* that can be understood as repositioning parts whose organization has been disturbed or disrupted, and was also used to designate the treatment of dislocated bones (see fig. 17).
- [11] The flip-flop, whose name is a vestige of the noise that the electromechanical devices were emitting, are the building block of digital electronics. They are used to count and for synchronizing variably timed input signals to some reference timing signal. They operate with a Boolean binary logic and can be considered circuits with 1 bit memory.

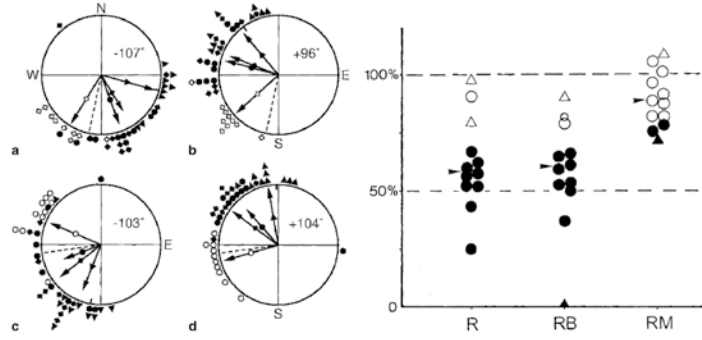
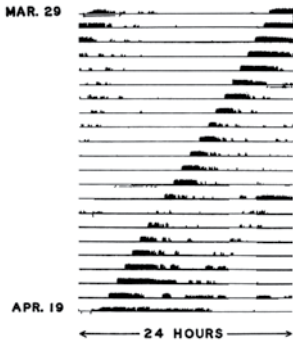

14 Circadian activity rhythm of a female mouse kept in constant darkness. Table from page 421 in: Joseph Altman. *Organic Foundations of Animal Behavior*. New York: Ardent Media, 1966. Web.

15 Tables from pages 395 and 397 in: Roswitha and Wolfgang Wiltschko. "Clock-shift Experiments with Homing Pigeons: A Compromise between Solar and Magnetic Information?" *Behavioral Ecology and Sociobiology* 49.5 (2001): 393-400. Web.

16 Categories of book recommendations by Amazon with the query "reset."

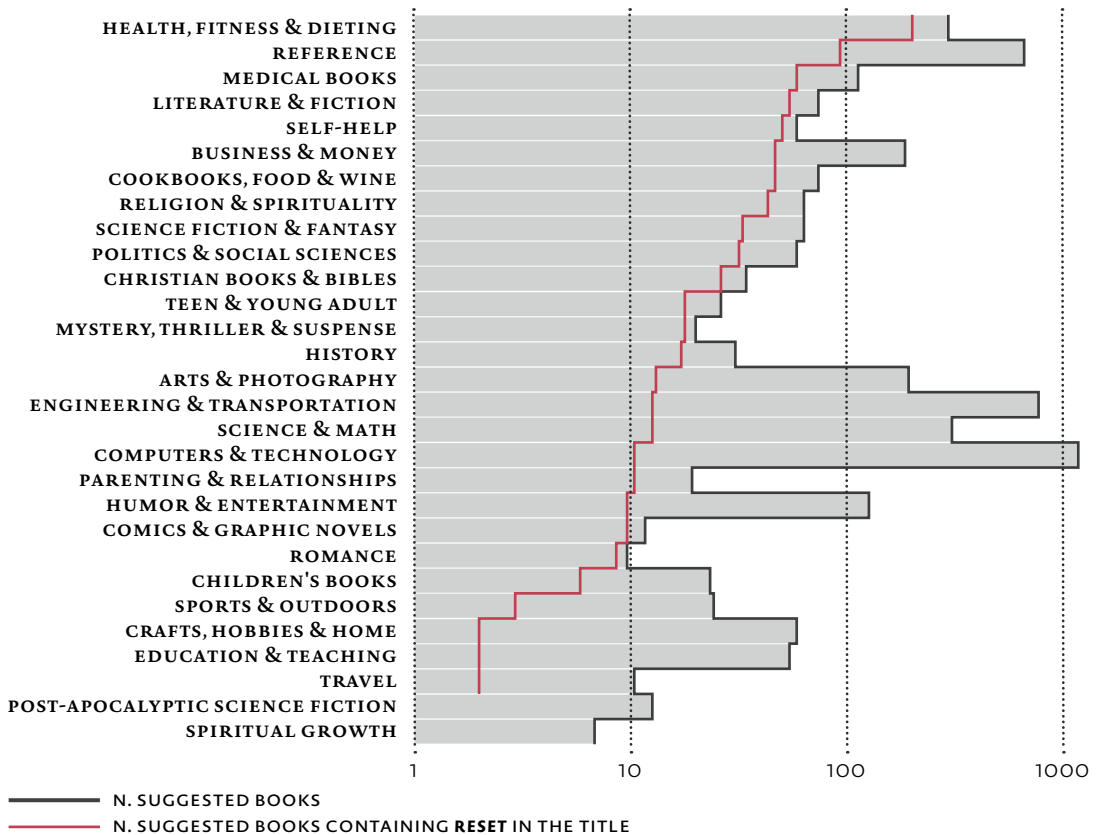





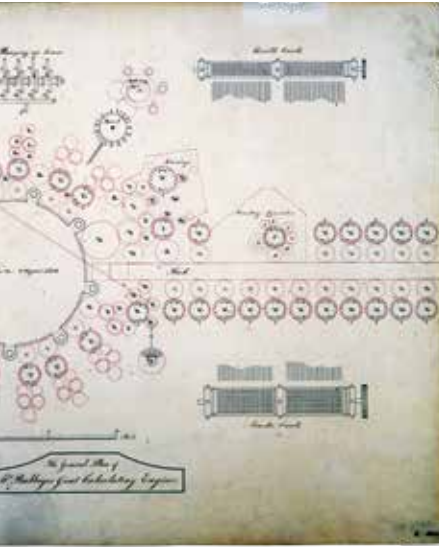

19 General plan of Charles Babbage's "Analytical Engine." Engraving, 1840. London, Science Museum. Philadelphia, 1946. Web.

148,582. ECCLES & another's COMPLETE SPECIFICATION.

(2 FREET)

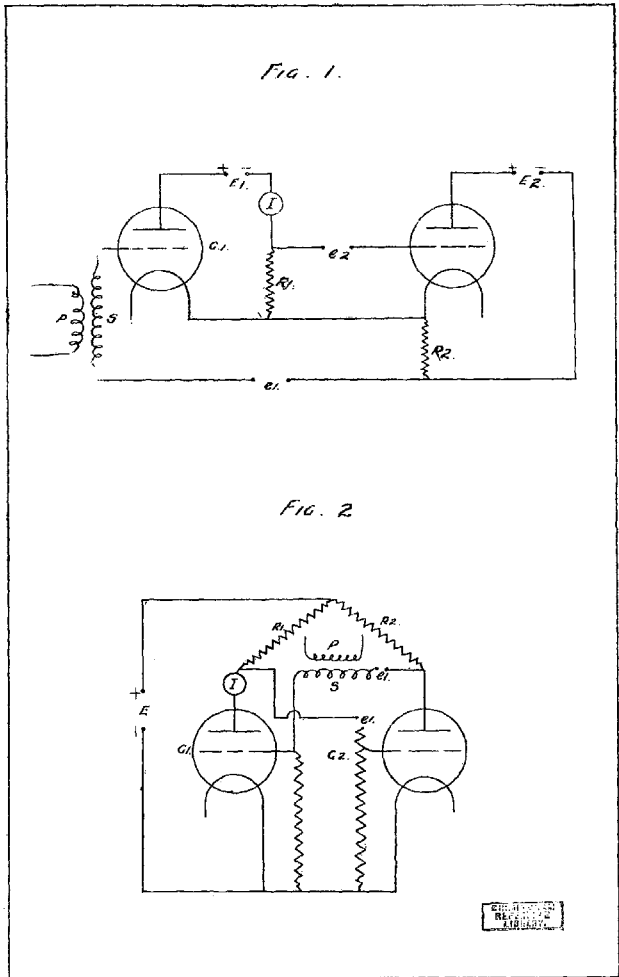

[This Drawing is a reproduction of the Original on a reduced scale.]

Mally & Sons, Photo Lith.

20 William H. Eccles and Frank W. Jordan. "Improvements in Ionic Relays." Patent drawing. GB Patent 148582, filed 21 June 1918, and issued 5 Aug. 1920. Web.

hundreds of cables – still required its programs to be manually inserted and a manual reset of its plugs and switches, it had 1500 flip-flops that gave it the possibility of executing computational cycles like INITIAL CONDITIONS → RESET → COMPUTE → RESET → COMPUTE → etc. Probably, from that moment on, the 0 state, hidden in the flip-flop, invisible to the eyes, and for this reason incorruptible, became an immaculate ideal state from which to start and come back to in case of error.

When the calculation loop becomes “rotten,” you have an external reset button capable of returning the machine to its initial state. It is a state that can be invoked and evoked. Nevertheless, inside any computer, blurred by a binary logic and invisible, a long chain of mediation is still active. While reset and refresh processes are running to ensure the stability of the processors, in case of a main system failure an agent is still triggering a long reset procedure: it instructs the CPU to list all the errors, to write a log report, to desperately save the unsaved data, to activate a shutdown process (hopefully not disconnecting itself from the power source) that in turn imparts the order to clean the memory.<sup>[13]</sup> At that point by using a reset vector the CPU will find an address where the first instructions are stored that it will perform after executing a reset: the re-boot.

## REMEDATING AN IDEAL

THIS CHAINED ASSEMBLY of techniques and algorithms that is anything but neutral (Gillespie), stays invisible. What is left is the button, used as narrative expedient in storytelling – the reset button technique – and used clumsily in international political affairs.<sup>[14]</sup> Buttons are everywhere because they initiate immediate actions, because they are seductive, because they are a potential for interaction. But they are always working under the regime of analogy and metaphor: rare are the buttons nowadays acting on steel gear and lever by transmitting the force of a body to the metal components. They relentlessly select and hide part of the system by casting a light on other ones. They are the wireframe of a situation. But still, as a vestige of mechanical connections, they are trustworthy because we presume that we can predict what will happen after being pressed: “they always precipitate the same action” (Pold 32). While they try to remediate their old analog existence (Bolter and Grusin) by offering something easy and well known, they detour our common limited understanding of the human-machine-society assemblage. We should know that by clicking, double-clicking, hitting, and pressing, we are manipulating several layers of symbolic instances (Johnson), but we ignore it. It is easy to describe what we do when accepting the terms and conditions of any web service or software: just click. But in that case either you accept the terms or you don't,

[13] A long chain of mediation is active also outside the computer, think for example about the moments when the reset button is activated because the system is not responding, you will call a help desk, a friend, look on your mobile for a forum searching for a troubleshooting procedure, describing in this way one of the most common socio-technical assemblages. This example describes the reset procedure for a classical personal computer, other personal devices as reset procedures are intended the ones trying to put back the device to the factory settings, that to some extent is linked to more extreme actions like formatting.

[14] In 2009, United States Secretary of State Hillary Clinton and Foreign Minister of Russia Sergey Lavrov, after a diplomatic meeting pressed a symbolic red button (see fig. 2, r·M!382; Kharkhordin, r·M!381–86). The button had two words on it: one in English, and one in Russian. Lavrov explained to Clinton that the Russian words used stand for “overcharge” and not for “reset.” Besides mentioning the translation error, the *New York Times* technology columnist J. D. Biersdorfer commented: “[R]eset, as in reset button – that’s a nice, comforting physical switch you find on everything around the house from electrical outlets to video game consoles. Push that button, and everything is supposed to be all right. Everyone wants the magic button” (Safire).

no middle ground is on offer. Nevertheless, the buttons make you feel in control by compressing part of society, technical knowledge, mediations, and transformations in a ready-to-be-run package. They do that also in a noncomputer related environment, when there is no ideal state or normal condition to go back to. So better not push that button but still rely on the reset, as a long, calm, patient, and puzzling procedure.

This is why, in spite of the complicated history of those technical devices, evolving from the mechanical to the digital, from the mundane to the highly sophisticated, from the esoteric to the cliché, we have chosen this ambiguous term for the title of the book and the exhibition. The reason has to do with its nice contrast to “tabula rasa,” “revolution,” and “iconoclasm,” which are frequent tropes in modernist discourse when talking about a clean break. A reset does not break anything; on the contrary, reset is a somewhat fresh term for something that does not refer to critique, simply to embarrassment, accumulation of bugs, and excessive complication. It also has the advantage, especially in its mechanical examples, to be close to the key notion of *procedure*, which we have been using throughout this entire book. Finally, it may help readers to get used to the odd situation of mild panic generated by the requirement to reset their recording instruments. There is nothing direct, instantaneous, easy, in the apparent simple movement of pushing the reset button, especially when modernism is at stake!

---

#### Works Cited

- Altice, Nathan. *I Am Error: The Nintendo Family Computer Entertainment System Platform*. Cambridge, MA: The MIT Press, 2015. Print.
- Baudrillard, Jean. *The System of Objects*. Trans. James Benedict. London: Verso, 1996. Print.
- Bogost, Ian. “The Cathedral of Computation.” *The Atlantic.com*. Atlantic Monthly Group, 15 Jan. 2015. Web. 13 Dec. 2015. Available at <<http://www.theatlantic.com/technology/archive/2015/01/the-cathedral-of-computation/384300/>>.
- Bolter, Jay David, and Richard Grusin. *Remediation: Understanding New Media*. Cambridge, MA: The MIT Press, 2000. Print.
- Carr, Nicholas. “Is Google Making Us Stupid?” *The Atlantic.com*. Atlantic Monthly Group, July–Aug. 2008. Web. 13 Dec. 2015. Available at <<http://www.theatlantic.com/magazine/archive/2008/07/is-google-making-us-stupid/306868/>>.
- Consalvo, Mia. *Cheating: Gaining Advantage in Videogames*. Cambridge, MA: The MIT Press, 2007. Print.
- Drucker, Johanna, and Emily McVarish. *Graphic Design History: A Critical Guide*. Upper Saddle River: Pearson Prentice Hall, 2009. Print.
- Essinger, James. *Jacquard’s Web: How a Hand-Loom Led to the Birth of the Information Age*. Oxford: Oxford University Press, 2004. Print.
- Gillespie, Tarleton. “The Relevance of Algorithms.” *Media Technologies: Essays on Communication, Materiality, and Society*. Ed. Tarleton Gillespie, Pablo J. Boczkowski, and Kirsten A. Foot. Cambridge, MA: The MIT Press, 2014. Print.
- Johnson, Steven. *Interface Culture: How New Technology Transforms the Way We Create and Communicate*. New York: Basic Books, 1997. Print.
- Kharkordin, Oleg. “Resetting Modernity: A Russian Version.” *Reset Modernity!* Ed. Bruno Latour. Cambridge, MA: The MIT Press, 2016. 381–86. Print.
- Mumford, Lewis. *Technics and Civilization*. 1934. Chicago: The University of Chicago Press, 2010. Print.
- NASA. *Shuttle Crew Operations Manual*. United Space Alliance, LLC, 15 Dec. 2008. PDF file.
- Pold, Søren. “Button.” *Software Studies: A Lexicon*. Ed. Matthew Fuller. Cambridge, MA: The MIT Press, 2008. Print.
- Safire, William. “Reset Button.” *The New York Times Magazine*. New York Times, 1 Apr. 2009. Web. 13 Dec. 2015. Available at <[http://www.nytimes.com/2009/04/05/magazine/05wwln-safire-t.html?\\_r=0](http://www.nytimes.com/2009/04/05/magazine/05wwln-safire-t.html?_r=0)>.