



**HAL**  
open science

# The limitations and exceptions to copyright and related rights for libraries, research and teaching uses

Séverine Dusollier

► **To cite this version:**

Séverine Dusollier. The limitations and exceptions to copyright and related rights for libraries, research and teaching uses. Study on the Application of Directive 2001/29/EC on Copyright and Related Rights in the Information Society (the "InfoSoc Directive"), European Union, pp.243 - 414, 2013, 9789279299186. hal-03604035

**HAL Id: hal-03604035**

**<https://sciencespo.hal.science/hal-03604035v1>**

Submitted on 10 Mar 2022

**HAL** is a multi-disciplinary open access archive for the deposit and dissemination of scientific research documents, whether they are published or not. The documents may come from teaching and research institutions in France or abroad, or from public or private research centers.

L'archive ouverte pluridisciplinaire **HAL**, est destinée au dépôt et à la diffusion de documents scientifiques de niveau recherche, publiés ou non, émanant des établissements d'enseignement et de recherche français ou étrangers, des laboratoires publics ou privés.

Funded by



# STUDY ON THE APPLICATION OF DIRECTIVE 2001/29/EC ON COPYRIGHT AND RELATED RIGHTS IN THE INFORMATION SOCIETY (THE "INFOSOC DIRECTIVE")



in collaboration with  **crids**  
CENTRE DE RECHERCHE INFORMATION, DROIT ET SOCIÉTÉ

Jean-Paul **TRAILLE** (ed.), partner, De Wolf & Partners and lecturer, University of Namur

Séverine **DUSOLLIER**, professor, University of Namur, director, CRIDS

Sari **DEPREEUW**, De Wolf & Partners, Vrije Universiteit Brussel

Jean-Benoit **HUBIN**, De Wolf & Partners

François **COPPENS**, Brussels Bar

Amélie **de FRANQUEN**, De Wolf & Partners, University of Namur

The information and views set out in this study are those of the authors and do not necessarily reflect the official opinion of the Commission. The Commission does not guarantee the accuracy of the data included in this study. Neither the Commission nor any person acting on the Commission's behalf may be held responsible for the use which may be made of the information contained therein.

DOI: 10.2780/90141

ISBN: 978-92-79-29918-6

© European Union, 2013.

Reproduction is authorised provided the source is acknowledged.

## Introduction to the Study

This Study ("**Study on the application of Directive 2001/29/EC on copyright and related rights in the information society**") is the result of a study which the European Commission (DG MARKT) commissioned, in the context of Framework Contract PN/2009-35/D, to the Belgian law firm De Wolf & Partners ([www.dewolf-law.com](http://www.dewolf-law.com)).

The team of authors was lead by **Jean-Paul TRIAILLE**, partner at the Brussels law firm De Wolf & Partners and lecturer at the University of Namur, who coordinated the Study. With the Commission's approval, Jean-Paul Triaille has worked, for part of the Study, with the CRIDS (Centre de Recherche Information, Droit et Société), from the University of Namur ([www.crids.be](http://www.crids.be)), in particular with **Prof. Séverine DUSOLLIER**. Authors are lawyers at De Wolf & Partners and/or academics or researchers with the CRIDS.

The Study comprises an assessment of the extent to which the implementation of the Directive 2001/29/EC ("the InfoSoc Directive") is appropriate to the economic and technological realities of digital markets and has as its objective to evaluate whether and, if so, to what extent, further harmonisation in some areas of copyright is needed in order to enable the EU to capitalise on the opportunities of a digital single market. It takes into account the numerous and recent important decisions taken by the Court of Justice of the European Union (CJEU) and national courts since the last implementation report on the InfoSoc Directive, completed in 2007.

It however does not cover all provisions of the InfoSoc Directive but only **a number of topics, selected by the European Commission** and listed in the Terms of Reference of this Study. The Study therefore concentrates on two important aspects of the InfoSoc Directive with regard to its assessment in the light of digital technologies and networks:

Regarding **exclusive rights**, the "making available right" and its localisation, and some other aspects of rights related to transmissions of content in digital networks (including links to the Satellite and Cable Directive and the Rental and Lending Directive);

Regarding **exceptions**, a number of key limitations and exceptions, notably in favour of:

- libraries and archives;
- research and educational purposes;
- persons with a disability;
- user-generated content (UGC);
- press review.

These selected topics should help the European Commission to assess to which extent the national copyright provisions are harmonised or not, and whether or not they form an impediment to cross-border exchange of services and information in the European Union.

The Study concentrates, as was asked by the European Commission, on **11 countries** (Germany, France, UK, Italy, Spain, Poland, Denmark, Hungary and the Benelux countries). It was carried out mainly as a desk research of accessible sources and verified by national experts in the countries under examination.

The authors also wish to **thank the experts** who provided useful insights and guidance for various parts of the study, in particular (in alphabetical order): Maciej **BARCZEWSKI** (attorney-at-law, and Head of Postgraduate Program in Intellectual Property and High Technology Law, University of Gdansk), Stéphanie **CARRÉ** (Maître de Conférences, CEIPI, Université de Strasbourg), Alexandre **CRUQUENAIRE** (Maître de Conférences, UNamur), Estelle **DERCLAYE** (Professor of Intellectual Property Law, Faculty of Social Sciences, University of Nottingham), Marc **FALLON** (Professor, University of Louvain-la-Neuve), Stéphanie **FRANCQ** (Professor, University of Louvain-la-Neuve), Jane C. **GINSBURG** (Morton L. Janklow Professor of Literary and Artistic Property Law, Columbia University), Giuseppe **MAZZIOTTI** (Center for European Policy Studies), Peter **MEZEI** (Assistant Professor at University of Szeged), Sylvie **NÉRISSON** (Max Planck Institute for Intellectual Property and Competition Law, Munich), Thomas **RIIS** (Professor at University of Copenhagen, Faculty of Law), Alain **STROWEL** (Professor, University of Saint-Louis and University of Louvain-la-Neuve), Raquel **XALABARDER PLANTADA** (Vicerectorat d'Ordenació Acadèmica i Professorat Directora Adjunta, Universitat Oberta de Catalunya).

Obviously, the responsibility for this Study and for the opinions expressed herein remains with its author(s).

A detailed **table of contents** at the beginning of the Study and **conclusions**, for each topic, will assist the readers to browse through the numerous pages of this report.

Some other topics are still being examined and the results will be made available to the European Commission before the end of the year.

Jean-Paul TRIAILLE  
October 2013

## Table of contents

Introduction to the Study .....	3
Table of contents .....	5
<b>PART I : EXCLUSIVE RIGHTS IN THE DIGITAL ENVIRONMENT .....</b>	<b>17</b>
<b>LOCALISATION OF THE ACT OF MAKING AVAILABLE TO THE PUBLIC AND ITS CONSEQUENCES.....</b>	<b>19</b>
Executive summary.....	21
General introduction to this part of the Study & Terms of Reference .....	23
<b>I. The right of making available to the public: <i>status quo</i>.....</b>	<b>25</b>
A. “Making available to the public”: notion .....	25
1. Origin .....	26
2. Scope of protection .....	26
a) Place in the InfoSoc Directive .....	27
(i) Making available right as a communication to the public.....	27
(ii) Making available right contrasted to the distribution right .....	28
b) Making available .....	32
c) To the public .....	39
d) On demand: access from a place and at a time individually chosen by the public .....	43
3. Conclusion on the making available right .....	44
B. Territoriality and localisation.....	45
1. Principle of state sovereignty: “National territoriality” of copyright.....	46
2. International protection: territoriality principle in the Berne Convention .....	46
3. Territorial reach of material acts .....	49
a) Material act v protected act .....	49
b) Territoriality and localisation in the CJEU decisions .....	51
(i) Lagardère.....	52
(ii) “Stichting De ThuisKopie” .....	54
(iii) Donner .....	55
(iv) Sportradar .....	56
c) Mitigation of the consequences of national territoriality .....	58
(i) The “country of origin” principle in the Satellite and Cable Directive.....	59
(ii) Exhaustion of the distribution right .....	61
d) Conclusions on the territoriality principle .....	62
C. Legal issues/consequences .....	63
1. Conflict of laws .....	64
a) Jurisdiction .....	64
(i) Provisional or protective measures .....	65
(ii) Contractual disputes.....	66
(iii) Non-contractual disputes .....	68
(iv) Intermediate conclusion.....	80

b)	Applicable law .....	81
(i)	Authorship and ownership .....	81
(ii)	Exploitation of the copyright .....	85
-	Law applicable to copyright contracts .....	85
-	Law applicable to non-contractual copyright infringement .....	87
(iii)	Intermediate conclusion .....	95
c)	General conclusion regarding private international law issues .....	96
2.	Authorship, ownership and transfer of rights .....	98
a)	National authorship rules .....	99
(i)	Application of the creator doctrine .....	99
(ii)	Special case: collective works .....	101
b)	National rules on transfer of rights / ownership .....	101
(i)	Allocation by law and initial ownership .....	101
-	Works created under the duties of an employment contract .....	102
-	Cinematographic and audiovisual works .....	103
(ii)	Transfer of rights by way of contract .....	105
c)	Impact of the existing disparities .....	105
(i)	Disparities on authorship, ownership and transfers of rights .....	105
-	Consequences of the current situation .....	107
3.	Reproduction right .....	109
a)	Scope of the reproduction right in the InfoSoc Directive .....	111
(i)	The reproduction right .....	111
(ii)	The exception for temporary acts of reproduction .....	113
-	Infopaq I & II and Premier League .....	114
-	Uncertainties .....	116
b)	Application of the reproduction right to “making available” processes .....	118
c)	Conclusions on the accumulation of the making available to the public right and the reproduction right 120	
D.	Bottlenecks .....	120
<b>II.</b>	<b>Localisation of the act of making available to the public: alternatives .....</b>	<b>124</b>
A.	Reflection on the notion of “making available to the public” per se .....	124
1.	Preliminary observations .....	125
a)	Technical scheme .....	125
b)	Presence of a “public” .....	126
2.	Alternative definitions .....	126
a)	Scenario 1: material act of upload .....	127
b)	Scenario 2: accessibility .....	128
c)	Scenario 3: exploitation .....	129
d)	Scenario 4: upload or accessibility or reception .....	131
e)	Conclusion on the alternative definitions .....	131
A.	“Country of origin” .....	132
1.	Principle .....	132
a)	Possible localisation criteria .....	134
(i)	Location of the servers on which the works are hosted .....	134
(ii)	Centre of activities of the uploader: establishment, domicile or habitual residence .....	135
(iii)	Geographical location of the material act of upload .....	137
b)	Criteria in other directives and the notion of “establishment” .....	139
(i)	Various criteria .....	139
(ii)	The notion of “establishment” and its location .....	142
-	E-Commerce Directive .....	142
-	AVMS Directive .....	143
-	Data Protection Directive .....	144

- Services Directive .....	144
- Some conclusions on the notion of “establishment” .....	145
c) Conclusions on the localisation criteria leading to a single Member State .....	145
2. Conflict of laws .....	147
a) Jurisdiction .....	147
b) Applicable law .....	148
3. Authorship, ownership and transfer of rights .....	149
a) Authorship and initial ownership .....	150
b) Transfer of rights .....	152
c) Impact of Premier League on the country of origin principle.....	153
4. Reproduction right.....	156
5. Intermediate conclusion .....	158
B. Exploitation of the work .....	162
1. Principle .....	162
2. Conflict of laws .....	166
a) Jurisdiction .....	166
b) Applicable law.....	167
3. Authorship, ownership and transfer of rights .....	167
a) Authorship and initial ownership .....	168
b) Transfer of rights .....	169
4. Reproduction right.....	170
5. Intermediate conclusion .....	172
<b>III. Conclusions .....</b>	<b>176</b>
A. Status quo .....	176
B. Alternative approaches.....	178
<b>Summarising table .....</b>	<b>182</b>
<b>Bibliography .....</b>	<b>185</b>
<b>Legislation .....</b>	<b>185</b>
<i>Treaties</i> .....	185
<i>Regulations</i> .....	185
<i>Directives</i> .....	185
<b>Decisions .....</b>	<b>186</b>
<i>CJEU</i> 186	
<i>Other</i> .....	188
<i>National Courts</i> .....	188
▪ Belgium .....	188
▪ France .....	188
▪ Germany .....	189
▪ Italy .....	189
▪ The Netherlands .....	190
▪ United Kingdom .....	190
▪ Australia, Canada, USA .....	191
<b>Scholarly literature .....</b>	<b>191</b>
<b>Reports and communications .....</b>	<b>195</b>



---

<b>THE RE-TRANSMISSION OF COPYRIGHT-PROTECTED CONTENT IN DIGITAL NETWORKS.....</b>	<b>197</b>
<b>THE RIGHT OF RETRANSMISSION BY CABLE.....</b>	<b>197</b>
<b>I. Terms of Reference.....</b>	<b>199</b>
<b>II. The cable retransmission right.....</b>	<b>200</b>
A. Introduction.....	200
B. Cable retransmission right in the SatCab Directive .....	204
1. Legal context.....	204
2. Cable retransmission right v right of communication to the public .....	207
3. Elements of the “cable retransmission” (art. 1(3) SatCab Dir). .....	213
a) Preliminary.....	215
b) Initial transmission.....	215
c) Retransmission .....	228
<b>III. Conclusions .....</b>	<b>233</b>
<b>Bibliography .....</b>	<b>235</b>
<b>Legislation .....</b>	<b>235</b>
▪ Austria.....	235
▪ Belgium .....	235
▪ Denmark .....	235
▪ France .....	235
▪ Germany .....	236
▪ Hungary.....	236
▪ Italy .....	236
▪ Luxemburg.....	236
▪ The Netherlands .....	236
▪ Poland.....	236
▪ Spain .....	236
▪ United Kingdom .....	236
<b>Court decisions .....</b>	<b>237</b>
▪ Austria.....	237
▪ Belgium .....	237
▪ Germany .....	238
▪ The Netherlands .....	238
<b>Scholarly literature .....</b>	<b>238</b>
<b>Reports and communications .....</b>	<b>239</b>
<b>PART II : EXCEPTIONS IN THE DIGITAL ENVIRONMENT.....</b>	<b>241</b>
<b>THE LIMITATIONS AND EXCEPTIONS TO COPYRIGHT AND RELATED RIGHTS FOR LIBRARIES, RESEARCH AND TEACHING USES.....</b>	<b>243</b>

<b>Introduction.....</b>	<b>245</b>
<b>I. The system of copyright exceptions in EU law .....</b>	<b>246</b>
A. The exceptions in the <i>acquis communautaire</i> .....	246
B. The exceptions in the InfoSoc Directive .....	248
C. The objectives of the exceptions in the InfoSoc Directive .....	249
D. The interpretation of the exceptions by the CJEU .....	251
E. Other principles applying to exceptions .....	253
1. Application of exceptions to unpublished works.....	253
2. Relationship of exceptions with licensing and market provision .....	255
<b>II. The exceptions benefiting to libraries.....</b>	<b>257</b>
A. Role and activities of libraries, archives and museums .....	258
1. The changing role of libraries, archives and museums.....	258
2. The activities of libraries.....	258
a) Activities related to setting up a collection .....	259
b) Activities of preservation .....	260
c) Specific acts of reproduction .....	261
d) Acts of communication or making available.....	261
e) Activities of lending .....	262
3. Intersection between libraries' activities and copyright exceptions .....	263
B. The exception for certain acts of reproduction made by libraries .....	264
1. Scope of the exception in the directive .....	264
a) Objectives .....	265
b) Beneficiaries .....	267
c) Works concerned .....	268
(i) General principle .....	268
(ii) Unpublished works .....	269
(iii) Computer programs and databases .....	269
(iv) Works still available on the market .....	270
d) Authorised acts .....	270
e) Further conditions .....	271
2. Implementation of the exception in the Member States .....	272
a) Objectives .....	272
b) Beneficiaries .....	273
(i) Types of Institutions .....	273
(ii) Functional requirements .....	274
c) Works concerned .....	275
d) Authorised acts .....	276
e) Further conditions .....	277
3. Overview of existing licensing mechanisms or collective agreements between stakeholders (namely for mass digitization) .....	278
4. Assessment of the exception – Issues and uncertainties .....	280
a) Assessment of the adequacy of the exception in the directive .....	280
b) Restrictive national transpositions .....	281
c) Lack of harmonization and cross-border issues.....	282
5. Possible options .....	284
a) Overarching principles and weighing factors .....	284
(i) The objective of the preservation and the role of cultural heritage institutions .....	285
(ii) The protection of rights and interests of copyright holders .....	285
(iii) The Balancing test .....	286
b) Revising the scope of the exception .....	286
(i) Keeping the status quo .....	286

(ii)	Adoption of an interpretative document .....	288
(iii)	Modification of the exception in the directive .....	289
-	The objectives of the exception .....	291
-	Beneficiaries – eligibility .....	294
-	Works concerned .....	295
-	Acts covered by the exception .....	297
-	Further conditions .....	299
c)	Efforts towards more harmonisation in Member States .....	300
(i)	Making the exception mandatory in the Member States .....	300
(ii)	An optional exception with precisely-defined conditions or objective .....	302
d)	Facilitating copyright clearance by libraries .....	303
(i)	Encouraging Memorandum of Understanding or other arrangements between stakeholders ...	304
(ii)	Compulsory collective management .....	305
(iii)	Extended collective licensing .....	305
C.	The exception for on-site consultation in libraries .....	307
1.	Scope of the exception in the directive .....	307
a)	Objectives .....	307
b)	Beneficiaries .....	308
c)	Works concerned .....	309
d)	Authorised acts .....	310
(i)	The explicit limitations of the exception .....	310
(ii)	Unsolved questions .....	312
e)	Further restrictions .....	313
f)	Concerned users .....	313
2.	Implementation of the exception in the Member States .....	313
a)	Objectives .....	313
b)	Beneficiaries .....	314
c)	Works concerned .....	314
d)	Authorised acts .....	314
e)	Further restrictions .....	315
f)	Concerned users .....	315
3.	Assessment of the exception – Issues and uncertainties .....	316
a)	Assessment of the adequacy of the exception in the directive .....	316
b)	National transpositions .....	317
4.	Possible options .....	317
a)	Overarching principles and weighing factors .....	318
b)	Revising the scope of the exception .....	318
(i)	The need to revise the exception or to maintain the status quo .....	318
(ii)	A possible modification of the exception .....	319
-	Unmodified conditions .....	319
-	Types of works .....	319
-	Technical and spatial limitations .....	319
D.	Digital public lending .....	323
1.	The context of public lending by libraries .....	324
a)	The different situations of lending in libraries .....	324
b)	The legal context of lending .....	326
(i)	The scope of public lending right in the European Union law .....	326
(ii)	The national implementations of the public lending right in Member States .....	328
2.	From lending to e-lending .....	331
a)	Development of e-lending through licensing .....	331
b)	Differences between lending and e-lending .....	333
c)	e-lending in EU law .....	334
3.	The revision of the regulatory framework .....	337

a)	The need and opportunity of a legislative initiative on e-lending .....	337
(i)	Objectives of lending .....	338
(ii)	Economic impact of e-lending .....	340
b)	The instruments of a legislative intervention .....	343
c)	Elements for an extension of the public lending right to e-lending .....	346
(i)	Objectives of the exception .....	347
(ii)	Beneficiaries .....	347
(iii)	Works concerned.....	348
(iv)	Authorised acts.....	348
(v)	Conditions.....	349
(vi)	Cross-border dimension .....	351
<b>III.</b>	<b>The exception for teaching and scientific research .....</b>	<b>352</b>
A.	Activities of education and research .....	353
1.	Educational uses .....	353
2.	Research uses .....	354
3.	Intersection between education and research activities and copyright exceptions .....	355
B.	The exception for education and research .....	357
1.	The international framework.....	357
a)	The exception in the Berne Convention .....	357
b)	Exceptions for education and research in other international treaties.....	358
2.	Education and research exception in the EU <i>acquis communautaire</i> .....	358
3.	The exception in the directive 2001/29.....	359
a)	Objectives .....	359
(i)	Illustration for teaching .....	359
(ii)	Scientific research .....	362
b)	Beneficiaries .....	364
c)	Works concerned .....	364
d)	Authorised acts .....	365
e)	The limitation to non-commercial purpose .....	365
f)	Other conditions .....	366
(i)	Indication of the source.....	366
(ii)	Fair compensation .....	367
4.	Other educational uses.....	367
5.	Implementation of the exception in the Member States .....	368
a)	Objectives .....	368
(i)	Illustration for teaching .....	368
(ii)	Scientific research .....	369
b)	Beneficiaries and users .....	371
c)	Works concerned .....	372
(i)	Type of works covered .....	372
(ii)	Quantity.....	373
d)	Authorized acts.....	373
(i)	Exclusive rights exempted by the exception .....	373
(ii)	The application to e-learning.....	374
e)	Other conditions .....	376
f)	Other exceptions for educational purpose.....	378
6.	Overview of existing licensing mechanisms or collective agreements between stakeholders .....	378
C.	Assessment of the exception for teaching – Issues and uncertainties .....	380
1.	Adequacy of the exception in the directive .....	380
2.	Restrictive national transposition.....	380
3.	Distance learning .....	381
a)	The cross-border dimension of e-learning.....	381

b)	Impact of the cross-border dimension on the localisation of the use .....	383
c)	Impact of the cross-border dimension on fair compensation .....	386
D.	Assessment of the exception for research – Issues and uncertainties .....	388
1.	Adequacy of the exception and its national implementation .....	388
2.	The cross-border dimension of research .....	389
E.	Possible options .....	389
1.	Overarching principles and weighing factors .....	389
2.	Separating education and research? .....	390
3.	Revising the scope of exception for teaching purposes .....	391
a)	Keeping the status quo .....	391
b)	Adoption of an interpretative document .....	391
c)	Modification of the exception in the directive .....	392
d)	Defining the conditions of the exception in a revision or interpretation of the directive.....	392
(i)	The objective of the exception .....	392
(ii)	Beneficiaries .....	392
(iii)	Works concerned.....	393
(iv)	Authorized acts.....	393
(v)	Not for direct or indirect commercial advantage .....	394
(vi)	Fair compensation .....	394
4.	Revising the scope of exception for research .....	394
a)	The objective of the exception .....	395
b)	Beneficiaries .....	395
c)	Works concerned .....	395
d)	Authorised acts .....	396
e)	Other conditions .....	396
5.	Efforts towards more harmonisation in Member States .....	397
a)	Making the exception mandatory .....	397
b)	An optional-exception with precisely defined conditions or objectives.....	398
c)	Solving cross-border issues.....	398
6.	Facilitating copyright clearance and collective agreements .....	400
<b>Conclusion</b> .....	<b>401</b>	
<b>Bibliography</b> .....	<b>404</b>	
<b>Books</b> .....	<b>404</b>	
<b>Articles</b> .....	<b>405</b>	
<b>Reports &amp; legislative documents</b> .....	<b>412</b>	
International reports .....	412	
European Union.....	412	
National reports.....	412	
▪ Belgium .....	412	
▪ France .....	413	
▪ The Netherlands .....	413	
▪ United Kingdom .....	413	
▪ United States .....	414	
<b>USES FOR THE BENEFIT OF PEOPLE WITH A DISABILITY</b> .....	<b>415</b>	
<b>Introduction</b> .....	<b>417</b>	

---

<b>I.</b>	<b>Terms of Reference.....</b>	<b>417</b>
<b>II.</b>	<b>The exception for disabled people in the InfoSoc Directive .....</b>	<b>417</b>
<b>III.</b>	<b>National implementation in the countries under consideration .....</b>	<b>420</b>
A.	Works and other protected subject matter.....	420
B.	Restricted acts .....	421
C.	Beneficiaries .....	422
D.	Purpose and additional conditions/restrictions .....	423
E.	Conclusions .....	428
<b>IV.</b>	<b>Bottlenecks.....</b>	<b>428</b>
A.	Cross-border accessibility .....	429
1.	Distribution of tangible copies.....	429
2.	Access online .....	434
<b>V.</b>	<b>Possible solutions .....</b>	<b>438</b>
	<b>Bibliography .....</b>	<b>444</b>
	<b>Cases .....</b>	<b>444</b>
	<b>Legislative and policy instruments .....</b>	<b>444</b>
	<b>Books.....</b>	<b>444</b>
	<b>Articles .....</b>	<b>444</b>
	<b>Studies.....</b>	<b>445</b>
	<b>USER GENERATED CONTENT (UGC) – FIRST PART .....</b>	<b>447</b>
	<b>Introduction.....</b>	<b>449</b>
	<b>Terms of reference .....</b>	<b>449</b>
<b>I.</b>	<b>Subject matter.....</b>	<b>450</b>
<b>II.</b>	<b>Definition(s) of UGC.....</b>	<b>452</b>
<b>III.</b>	<b>Some available figures.....</b>	<b>455</b>
<b>IV.</b>	<b>The Commission’s position on UGC .....</b>	<b>457</b>
<b>V.</b>	<b>Which exclusive rights are at stake ? .....</b>	<b>459</b>
A.	The reproduction right .....	459
B.	The communication to the public right, including the right to make available.....	460
C.	The right of adaptation .....	461
<b>VI.</b>	<b>Which moral rights are at stake? .....</b>	<b>462</b>
<b>VII.</b>	<b>Which exceptions from the InfoSoc Directive are relevant? .....</b>	<b>464</b>

A.	Quotation for criticism or review .....	464
1.	General presentation.....	464
2.	Implementation of the exception in the Member States:.....	465
3.	General observations on the quotation exception.....	472
4.	Case-law of the Court of Justice .....	473
B.	Caricature, parody and pastiche.....	475
1.	General presentation.....	475
2.	Analysis in the Member States .....	476
3.	General observations on parodies, caricatures and pastiches .....	481
C.	Incidental inclusion .....	482
1.	General presentation.....	482
2.	Analysis in the Member States .....	483
3.	General observations on the incidental use exception: .....	487
<b>VIII.</b>	<b>Overview of some recent case law on UGC.....</b>	<b>487</b>
A.	Relevant case law of the EUCJ .....	487
1.	The interpretation of the exceptions.....	487
2.	The margin enjoyed by the Member States in the implementation and the interpretation of the exceptions.....	489
B.	National case law on UGC.....	491
1.	Lenz v. Universal .....	492
2.	Warner Bros. and J. K. Rowling v. RDR Books.....	493
3.	Side cases concerning sampling.....	495
<b>IX.</b>	<b>A chilling effect of the actual legal framework? .....</b>	<b>497</b>
<b>X.</b>	<b>The solutions proposed by the stakeholders .....</b>	<b>499</b>
<b>XI.</b>	<b>Which other arguments do courts or commentators rely on to allow UGC? .....</b>	<b>504</b>
A.	Freedom of expression .....	505
B.	The freedom of trade and of competition.....	507
C.	The balance of interests .....	507
D.	The <i>ratio legis</i> of the exception .....	508
E.	Misuse of copyright .....	509
F.	Implied consent .....	509
<b>XII.</b>	<b>Preliminary conclusions .....</b>	<b>510</b>
	<b>USER GENERATED CONTENT (UGC) – SECOND PART .....</b>	<b>511</b>
	<b>Introduction.....</b>	<b>513</b>
	<b>Terms of reference .....</b>	<b>513</b>
<b>I.</b>	<b>Subject matter.....</b>	<b>514</b>
<b>II.</b>	<b>Possible actions within the existing framework.....</b>	<b>515</b>
A.	Not taking any initiative.....	516
B.	Facilitating MoUs or other arrangements between stakeholders.....	516
C.	Adopting an interpretative document (such as a Commission Communication) .....	517
D.	Encourage education and information initiatives .....	520

<b>III.</b>	<b>Possible actions requiring changes to the existing framework.....</b>	<b>522</b>
A.	Adapting and harmonizing the content of existing exceptions .....	522
B.	Adapting the characteristics of existing exceptions .....	527
1.	Making the three exceptions compulsory? .....	527
2.	Making the three exceptions imperative/unwaivable? .....	528
3.	An additional question: who should be the beneficiaries of the exception? .....	530
C.	Adopting an explicit UGC exception .....	531
D.	Adopting a new and “horizontal” exception or a fair-use or “fair-use like” kind of exception .....	534
E.	Dealing with UGC via the e-Commerce Directive .....	539
<b>IV.</b>	<b>Conclusions .....</b>	<b>540</b>
	<b>Bibliography .....</b>	<b>543</b>
	<b>Scholarly literature .....</b>	<b>543</b>
	<b>Reports and communications .....</b>	<b>545</b>
	<b>PRESS REVIEW EXCEPTION FOR INSTITUTIONS AND ENTERPRISES THAT OFFER PRESS-CLIPPINGS TO THEIR SUBSCRIBERS OR EMPLOYEES .....</b>	<b>547</b>
	<b>Terms of reference .....</b>	<b>549</b>
<b>I.</b>	<b>The exception for press review in the Information Society Directive .....</b>	<b>549</b>
A.	Origin .....	550
B.	Objective.....	552
C.	Conditions.....	553
D.	Article 5(3)(c) in the case law of the European Court of Justice.....	556
<b>II.</b>	<b>Press clippings .....</b>	<b>556</b>
A.	Notion of press clippings and related concepts.....	557
B.	Stakeholders involved.....	558
C.	Protection of press clippings .....	558
<b>III.</b>	<b>Application .....</b>	<b>559</b>
A.	The offer by an organisation to its employees .....	561
B.	The offer by a (commercial) entity to its subscribers .....	564
C.	The offer by any legal entity or natural person to the general public.....	566
<b>IV.</b>	<b>Practices in the selected Member States .....</b>	<b>567</b>
A.	The offer by an organisation to its employees .....	570
1.	The Netherlands .....	570
2.	Germany .....	572
3.	Denmark .....	573
B.	The offer by a (commercial) entity to its subscribers .....	573
1.	The Netherlands .....	574
2.	Italy .....	574
3.	Germany .....	575
4.	Denmark .....	575
5.	United Kingdom .....	575
C.	The offer by any legal entity or natural person to the general public.....	576
1.	The Netherlands .....	577



---

2.	Germany .....	578
3.	France .....	579
4.	Belgium .....	579
<b>V.</b>	<b>Conclusions .....</b>	<b>580</b>
	<b>Bibliography .....</b>	<b>583</b>



**DE WOLF & PARTNERS**

## **PART I : Exclusive rights in the digital environment**



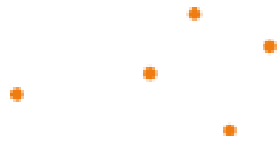

## Study on the territoriality of the making available right

### Localisation of the act of making available to the public and its consequences

By **Sari DEPREEUW** (PhD) (De Wolf & Partners) and **Jean-Benoît HUBIN** (De Wolf & Partners)

under the supervision of **Jean-Paul TRIAILLE** (De Wolf & Partners, University of Namur)

The authors thank the following persons for their valued contributions to this Study: Maciej BARCZEWSKI (attorney-at-law, and Head of Postgraduate Program in Intellectual Property and High Technology Law, University of Gdansk), Stéphanie CARRÉ (Maître de Conférences, CEIPI, Université de Strasbourg), Alexandre CRUQUENAIRE (Maître de Conférences, UNamur), Estelle DERCLAYE (Professor of Intellectual Property Law, Faculty of Social Sciences, University of Nottingham), Séverine DUSOLLIER (Professor UNamur, Director Centre de recherche Information, Droit et Société), Marc FALLON (Professor, University of Louvain-la-Neuve), Stéphanie FRANCO (Professor, University of Louvain-la-Neuve) Jane C. GINSBURG (Morton L. Janklow Professor of Literary and Artistic Property Law, Columbia University), Giuseppe MAZZIOTTI (Center for European Policy Studies), Peter MEZEI (Assistant Professor at University of Szeged), Sylvie NÉRISSON (Max Planck Institute for Intellectual Property and Competition Law, Munich), Thomas RIIS (Professor at University of Copenhagen, Faculty of Law), Alain STROWEL (Professor, University of Louvain-la-Neuve), Raquel XALABARDER PLANTADA (Vicerectorat d'Ordenació Acadèmica i Professorat Directora Adjunta, Universitat Oberta de Catalunya).

The responsibility for this Study and for the opinions expressed herein remains with its author(s).



## Executive summary

This Study first focuses on the territoriality of the making available right and its consequences for the functioning of the internal market.

**I. Scope of the making available right.** The Study first examines the origin of the making available right and its current scope. It observes that the notion of making a work available to the public is not defined and an important uncertainty exists concerning its scope of protection. The national courts have contributed to the clarification of this exclusive economic right by applying it to various online services. The making available right requires not only that the protected matter be uploaded so it can be accessed at a distance (at any time and location), it should also be demonstrated that access is offered to members of the public. The exact scope of the making available right by contrast is not clear, in particular whether the transmission of protected matter, following the accessibility, is covered. Decisive to distinguish the act of making available from other forms of communication to the public (in particular broadcasting) is the accessibility at the time chosen by the user/member of the public (timing, order, scope). Also, the relation of the making available right to the rights of reproduction and communication to the public is not clarified (alternative or cumulative application).

**Notion of territoriality.** The notion of territoriality is then explored in the Study. Harmonisation efforts at the international and European levels have not altered the competence of the national legislators to regulate copyright. Moreover this principle of “national territoriality” is confirmed by the Court of Justice of the European Union, although the “territorial” criteria may vary. The territoriality principle is a cornerstone of the international protection offered by the Berne Convention. Finally, the territorial reach of the making available right is uncertain, while clarity on this point is a prerequisite for the application of mitigating principles such as the “country of origin” principle in relation to satellite broadcasting and the “exhaustion” principle in relation to the distribution right.

**Selected legal issues.** Because of these uncertainties, the constitutive elements of a (cross-border) act of making available may be found to take place in different Member States. At the request of the Commission, the Study focuses on three issues and how these are affected by the absence of a clear definition and localisation criterion:

- **Private international law.** The lack of clarity causes issues of private international law, as several Member States may have concurrent jurisdiction to rule on a case regarding an infringement to the making available right. Moreover, the rules determining the applicable law may lead to inconsistencies, as they can refer to the application of one single or several copyright legislations depending on the Member State in which the claim is introduced.
- **Authorship, ownership, transfer of rights.** As to these issues, the Study points out at the existence of disparities in the copyright legislation of the Member States of the European Union. Consequently, the localisation of the making available right may have an impact on the identity of the right holder. Several people may hold rights to relevant acts that are part of a complex process of making available (fragmentation of rights).
- **Reproduction right.** Turning to the relation between the making available right and the right of reproduction, the Study identifies the existence of different acts of reproduction in the process of the act of making available. This may complicate the licensing of works for online use and have an impact on the localisation of the protected acts in case of infringement. Further study in this respect is needed.

**II.** Having presented the legal issues related to the current situation, the second part of the Study examines whether specific localisation criteria would help solving the bottlenecks identified in the first part.

This part of the Study first examines different possibilities to define and delineate the scope of the making available right. Then, the Study analyses two localisation criteria (country of origin principle and place of the exploitation of the work) and assesses their consequences on the issues of conflict of laws, authorship, transfer of rights and reproduction right:

- **Country of origin.** This approach localises the act of making available in one single Member State (“country of origin”). It is reminded however that the country of origin principle may be interpreted in various ways (cf. several European directives with a “country of origin” principle). Applied to the making available right, the country of origin principle could localise the protected act either in the country where the act of upload takes place or in the country where the uploader is established. It is then verified whether this approach would provide a satisfactory answer to the bottlenecks identified in the first part. It is concluded that the country of origin principle solves some but not all the bottlenecks and that it may generate new bottlenecks with regard to the applicable law.
- **Exploitation/targeting.** The second criterion proposed to localise the making available right is based on an exploitation approach. According to this criterion, the act of making available is localised in each country where a public is targeted. The outcome of such proposal is to reduce the number of countries where the making available right may potentially be localised (the mere accessibility of the work in a country is not a relevant criterion anymore). The exploitation approach does not solve the bottlenecks identified in the first part of the Study but it helps reducing their impact.

*For a more detailed presentation of the issues being addressed or the topics described in this Executive Summary, please refer also to the conclusions.*

## General introduction to this part of the Study & Terms of Reference

The Information Society Directive<sup>1</sup> was adopted in 2001 and it has provided a regular reporting on its application (art. 12). A first report on the implementation and application of its provisions in the national legislation of the Member States was delivered by the IViR in 2007<sup>2</sup>. The present Study was commissioned to provide an updated evaluation of the impacts of the InfoSoc Directive in certain key areas. Not all aspects of the Information Society Directive are treated and neither is it an update of the country-by-country report by the IViR. The Commission has formulated its priorities in the Terms of Reference for this Study as follows:

### **The "making available right" and other aspects of rights related to transmissions of content in digital networks**

#### **The territoriality of online rights in the Single Market**

The protection of copyright and related rights in the EU is "territorial" in the sense that the recognition and enforcement of rights occurs on a country by country basis (nevertheless, the management of rights does not need to be territorial and right-holders are often in a position to grant multi-territorial licences). The balance between territoriality and the functioning of the internal market has been achieved, as far as the distribution of physical copies is concerned, by the principle of exhaustion developed by the CJEU and, as far as the act of communication to the public by satellite is concerned, by the definition of where the act takes place (one single Member State, often referred to as "country of origin" or uplink) in the Satellite and Cable Directive.

The main right applicable to on-line transmissions – the so-called "making available" right provided under Article 3 of the InfoSoc Directive – remains territorial in the sense that the act of making available is in all likelihood an act relevant in each of the Member States where the content is accessed (plus, probably, the country in which the content is uploaded). The question has arisen as to whether this is sustainable for the functioning of the internal market, and whether alternative approaches would not be more appropriate - in particular whether the "making available" should not be re-considered as a relevant copyright act only in the Member State in which the relevant online service originates/the service provider is established. This approach is similar to that applied in the copyright 'acquis', to the act of communication to the public by satellite. The reproduction right is equally relevant, certainly in the case of downloads where clearly an act relevant for copyright purposes would happen (independently of where the act of "making available" is defined as taking place) in each of the countries where end users download digital files. This is an aspect that did not arise in the context of satellite broadcasting.

#### **Outputs to be achieved**

With regard to Article 3 of the InfoSoc Directive, the Study should look into the question as to whether national courts assume that the Directive harmonised substantial copyright law in a way that would include the determination of the place where the relevant copyright act occurs. It should explore where

---

<sup>1</sup> Directive 2001/29/EC of the European Parliament and of the Council of 22 May 2001 on the harmonisation of certain aspects of copyright and related rights in the information society, OJ L 167, 22 June 2001, p. 10–19, hereafter referred to as "Information Society Directive" or "InfoSoc Dir".

<sup>2</sup> L. GUIBAULT e.a., Study on the implementation and effect in Member States' laws of Directive 2001/29/EC on the harmonisation of certain aspects of copyright and related rights in the information society, Institute for Information Law (IViR), Amsterdam, 2007, p. 25-29.



the relevant acts that fall under the above mentioned right are deemed to occur under the applicable substantial national law. Where appropriate, the Study should also analyse case law dealing with related questions on applicable law (see Article 8 of Regulation 864/2007) and jurisdiction (see Article 5 of Regulation 44/2001). We do not expect a large body of jurisprudence to exist in the EU on this matter so important existing case law in third countries (US, Canada, Australia, Japan) on the issue of "where does the act of making available take place" should be examined if it exists. Discussions in academia should also be taken into consideration with regard to these particular questions.

**Output** : Examine the implications of the application of the "country of origin" principle (applicable/substantive law) to:

(a) Enforcement measures: identification of specific issues relating to the enforcement of copyright and related rights in the country of destination (damages and injunctive relief; examination of relationship with Regulation 44/2001).

(b) Determinations of authorship: what would be the (legal and economic) consequences of maintaining the *status quo* (limited harmonisation of this matter, i.e. harmonisation of authorship limited to Article 2(2) of the rental directive) while implementing this principle? Is the harmonisation of authorship necessary or desirable in order to give effect to the country of origin principle? Are there other issues of substantive law that would need to be harmonised (or further harmonised) e.g. exceptions.

(c) Transfer of rights/ownership: what would be the effect of maintaining the *status quo* (transfer of rights are not harmonised in the Community *acquis*) while implementing the country of origin principle? (Relationship with Regulation 593/2008)

(d) The reproduction right: there will be a need also to examine the link between the application of the "country of origin" and the reproduction right associated with certain acts of making available e.g. downloads

This Study will focus on the making available right (art. 3 InfoSoc Dir). It consists of two parts, the first describing the current state of the law ("status quo") and the second exploring alternative approaches to the making available right.

In the first part, the current understanding of the making available right will be examined in further detail, i.e. its application by the national courts. Next, the territoriality principle will be analysed and it will be verified how acts of making available should be localised within the European Union. Finally, a selection of legal issues will be presented under the national copyright laws of the Member States under consideration (as harmonised at the European level), i.e. issues of authorship, initial ownership and transfer of rights, the reproduction right and conflicts of law. This will give us an idea of the effects of the making available right, in combination with the territoriality principle.

In the second part of the Study, we propose a reflection on the making available right, both in terms of its definition and the localisation criteria. We will develop two interpretations of the making available right, which are each connected to a specific localisation criterion: in a "country of origin" or in the Member State(s) of exploitation. Finally, it will be examined how the selected legal issues (issues of authorship, initial ownership and transfer of rights, the reproduction right and conflicts of law) would be affected under each alternative approach.

**Methodology.** For this Study we operated in two phases. In the first phase, we have examined the accessible sources (in English, French, Dutch and, to a lesser extent, German) on the national copyright laws of a limited number of Member States (i.e. Germany, France, UK, Italy, Spain and Poland, Denmark, Hungary and Benelux). In a second phase we have consulted national experts to verify and complement our research.

We have consulted sources going back to 2006, the previous period being covered in the IViR studies. The research period ends on 30 June 2013.

## I. The right of making available to the public: *status quo*

The first part of this Study will bring together the current notion of the “making available right” and the current understanding of the “territoriality” principle. The relation between the making available right and the “territorial” nature of copyright protection is examined in the context of the Information Society Directive.

The protection and enforcement of the exclusive rights in copyright is organised on the national level, but this principle of national territoriality is challenged by multi-territorial transactions, in particular Internet transactions which (mostly) cover more than one national territory. This tension appears sharply in the making available right.

Before considering the potential issues arising from the territorial nature of the making available right, it is necessary to examine the content of this particular right. First, it will be examined how the right of making available to the public is applied and understood in the Member States, by the national courts and in scholarly literature (*sub A*). Then a closer look will be given to the territoriality principle, as it is understood by the Court of Justice of the European Union (CJEU) and at the international level. We will then summarise the territorial reach of the material acts protected under copyright and how the legal consequences are mitigated in the European copyright context (by the “country of origin” principle for satellite broadcasts and the exhaustion principle for the distribution of goods). (*sub B*).

It is assumed that the uncertain scope of the making available right and the principle of national territoriality of copyright (and therefore the making available right) lead to a legal uncertainty as to the overall protection offered under this exclusive right. This assumption is tested in the last section of this part, where selected legal issues are described (*sub C*). We will describe the current state of conflict of law rules (jurisdiction and applicable law), the national rules on authorship, initial ownership and transfer of right, and finally a description of the cumulative protection under the reproduction right will be given<sup>3</sup>.

### A. “Making available to the public”: notion

As a start of our reflection on the making available right and its territorial attaches, the first challenge is to understand which acts are exactly protected under this particular exclusive right. The notion of making a work or other protected subject matter available to the public should be delineated before it can be attached to the territory of one (or several) Member State(s).

Following the Information Society Directive, the Member States are obliged to protect as an act of communication to the public: “*the making available to the public of their works in such a way that members of the public may access them from a place and at a time individually chosen by them*” (art. 3 InfoSoc Directive). This right was granted, as a part of the general right of communication to the public, for authors and, as a specific right, for performers, phonogram producers, producers of the first fixations of films and broadcasting organisations<sup>4</sup>.

The directive does not provide a precise definition of the making available right: it is not clear which material acts are actually covered under this right and, importantly, which acts are not. This lack of definition entails the risk that this exclusive economic right is interpreted differently in the Member States. The Court of Justice has not had the occasion to provide a definition of the right of making available to the

---

<sup>3</sup> For this study, the national laws of 11 Member States of the European Union are examined : Germany, France, United Kingdom, Benelux, Poland, Hungary, Denmark, Italy and Spain. No reported case law was found for Denmark on the making available right.

<sup>4</sup> This right was examined in the IViR Study on the implementation and effect of Directive 2001/29, p. 25-29.

public. It has touched upon related issues in *Sportradar* (reutilisation right of protected databases) and in *UsedSoft* (distribution right of computer programs) but neither case allows conclusions for the making available right as protected in the Information Society Directive.

In this section, the general background of the making available right will be brought back to mind. Then it will be examined in the accessible sources whether, after the 2007 IViR study on the implementation and the effect of the Information Society Directive, this notion has been clarified in the selected Member States' court decisions or scholarly literature. This approach will allow us to examine the implications of the territorial nature of this exclusive economic right.

## 1. Origin

The right of making a work available to the public in the Information Society Directive has its origin in the WIPO Internet Treaties (1996)<sup>5</sup>. The WCT provides the “*exclusive right of authorizing any communication to the public of their works, by wire or wireless means, including the making available to the public of their works in such a way that members of the public may access these works from a place and at a time individually chosen by them*” in favour of authors of literary and artistic works (art. 8 WCT), thus completing the specific rights recognised in the Berne Convention (Articles 11(1)(ii), 11bis(1)(i) and (ii), 11ter(1)(ii), 14(1)(ii) and 14bis(1) BC). The WPPT provides this right in favour of performers and producers of phonograms (for the performances fixed in phonograms resp. the phonograms – art. 10 and 14 WPPT).

As a contracting party, the European Union had the obligation to implement this protection in its own legal order (and therefore the Member States'). The fact that the making available right in the Information Society Directive has its origin in the WIPO Internet Treaties entails that the WIPO documents can be used for the interpretation of this right at the European and national levels<sup>6</sup>.

## 2. Scope of protection

The Information Society Directive grants the making available right to authors (of all types of works), performers, producers of phonograms and first fixations of films and broadcasting organisations, each for their own protected subject matter.

The making available right has a broad and general scope. It applies regardless of the technology used to make the protected subject matter available to the public (Internet technology, including Web applications or interactive television) or to access the protected materials (computers, television sets, “smart phones” or other portable devices). Consequently the making available right has its importance for various commercial or non-commercial sectors (the music and audiovisual sectors, book and news publishing, but also for less traditional sectors in which more non-professional “users” are active, such as blogging and social networking sites). In this respect, the making available right is different from the right of satellite broadcasting, which is *de facto* only applied within the audiovisual sector.

The making available right should furthermore be understood in the context of the Information Society Directive. On the one hand its classification as a species of the right of communication to the public has certain ramifications, as does the distinction from the distribution right. These aspects will be examined here, before verifying how the making available right has been applied in the Member States.

---

5 WIPO Copyright Treaty (WCT) and WIPO Performances and Phonograms Treaty (WPPT), both adopted in Geneva on December 20, 1996.

6 See inter alia CJEU 7 December 2006, case C-306/05, SGAE v Rafael Hoteles (Rafael Hoteles); CJEU 15 March 2012, case C-135/10 Consorzio Fonografici v Del Corso (Del Corso).

### a) Place in the InfoSoc Directive

The making available right is embedded in the Information Society Directive, in which other exclusive economic rights are provided as well, in particular the right of communication to the public and the distribution right. The place given to the making available right in this Directive may teach us something about its content.

#### (i) Making available right as a communication to the public

At least as far as the authors' copyright is concerned, the making available right is protected as a species of the right of communication to the public, not as a *sui generis* right<sup>7</sup>. This general right of communication to the public in the Information Society Directive also protects other types of communication, such as broadcasting, simulcasting or webcasting (rec. 23 InfoSoc Dir). For example, in *TVCatchup*, the CJEU decided that the retransmission via the Internet of works included in terrestrial TV broadcasts should be considered a communication to the public in the sense of art. 3 InfoSoc Dir<sup>8</sup>.

The making available right is distinguished from the broadcasting right<sup>9</sup>. Whereas various aspects of the broadcasting right have been regulated in various directives (in order to limit it in the one or the other respect<sup>10</sup>), the exclusive nature of the making available right is explicitly confirmed in the Information Society Directive (rec. 25)<sup>11</sup>. The distinctive factor seems to be the control over the timing of transmission. In case of broadcasts or so-called "push services", the sender controls the transmission of the work (by contrast to the user choosing when and where to access the works at her individual demand). In case of a broadcast, the broadcaster determines the linear programme and the user's access coincides with the transmission of the programmes<sup>12</sup>. With a sliding scale of interactivity, such distinction is not always easy to make<sup>13</sup>. The exact delineation and relation between the rights of communication to the public, broadcasting and making available is beyond the scope of this Study.

The fact that the making available right is categorised under the legal umbrella of the communication to the public right logically entails that the (inherent) limitations to the right of communication to the public also apply to the making available right<sup>14</sup>. Consequently, the making available right only covers

7 This is not necessarily true for the making available right in the WIPO treaties : see B. LINDNER, "The WIPO Treaties" in B. LINDNER & T. SHAPIRO, *Copyright in the Information Society*, Edward Elgar, Cheltenham, 2011, 18.

8 CJEU 7 March 2013, case C-607/11, *ITV Broadcasting e.a. v TVCatchup* (TVCatchup).

9 See on the difficult delineation between both rights the IViR Study on the implementation and effect of Directive 2001/29, p. 27 et s. ; M. VAN EECHOUD, "Het Communautaire Acquis voor auteursrecht en naburige rechten: Zeven zonden of zestien gelukkige jaren?", *AMI* 2007, 4, 115.

10 See Council Directive 93/83/EEC of 27 September 1993 on the coordination of certain rules concerning copyright and rights related to copyright applicable to satellite broadcasting and cable retransmission OJ L 248, 6 October 1993, p. 15–21 (SatCab Directive) and Directive 2006/115/EC of the European Parliament and of the Council of 12 December 2006 on rental right and lending right and on certain rights related to copyright in the field of intellectual property (codified version), OJ L 376, 27 December 2006, p. 28–35 (Rental and Lending Directive).

11 In the case *Del Corso*, the distinction between the broadcasting right and the making available right was touched upon but no in depth analysis was made. The referring court had asked whether the listening to programmes in a dental practice is an act of making available to the public in the sense of the Information Society Directive. The CJEU reformulated this question to test this practice to the broadcasting right of art. 8(2) Directive 92/100. This reformulation was motivated succinctly in the sense that the issue in the main proceeding was the broadcasting of music in a dental practice for the benefit of the patients present and not interactive on-demand transmission. See *Del Corso*, par. 57-60.

12 S. VON LEWINSKI & M.M. WALTER, "Information Society Directive" in M.M. WALTER & S. VON LEWINSKI (ed), *European Copyright Law*, Oxford, University Press, 2010, 983 et s., nr. 11.3.31-33.

13 Cf. P.B. HUGENHOLTZ e.a., *The Recasting of Copyright & Related Rights for the Knowledge Economy*. IViR, 2006, accessible via [http://ec.europa.eu/internal\\_market/copyright/docs/studies/etd2005imd195recast\\_report\\_2006.pdf](http://ec.europa.eu/internal_market/copyright/docs/studies/etd2005imd195recast_report_2006.pdf), 56; VON LEWINSKI & WALTER, "Information Society Directive", 984, nr. 11.3.32-33.

14 In this sense : M. RICOLFI, 'Comunicazione al pubblico e distribuzione', *Annali Italiani Diritto Autore (AIDA)*, 2002, 61. This author considers that the concept of communication to the public should not be influenced by the various means of transmission through which content is delivered and by their distinct technical characteristics. According to this author, the right of

hypotheses in which access to protected subject matter is given to a “public”, as interpreted by the Court of Justice<sup>15</sup>. Furthermore, this qualification as an act of communication to the public should entail that the act of communicating is protected but not the act of merely receiving the work (in private)<sup>16</sup>.

All this entails that any legislative or interpretative intervention on the making available right should be coherent with the right of communication to the public. This is all the more pressing, considering that many service providers (such as streaming services) offer both “on demand” and “broadcasting” services. Any contradiction between the legal regimes to which either type of service is subject should be avoided.

### **(ii) Making available right contrasted to the distribution right**

The making available right may furthermore be contrasted to the distribution right (art. 4 InfoSoc Directive) or the rental or lending rights (art. 3 Rental and Lending Directive).

The Member States are required to provide “*for authors, in respect of the original of their works or of copies thereof, the exclusive right to authorise or prohibit any form of distribution to the public by sale or otherwise*” (art. 4 InfoSoc Dir). This distribution right is exhausted “*within the Community in respect of the original or copies of the work, except where the first sale or other transfer of ownership in the Community of that object is made by the rightholder or with his consent*” (art. 4(2) InfoSoc Dir)<sup>17</sup>.

The distribution right protects “*acts which entail, and only acts which entail, a transfer of the ownership of that object*”<sup>18</sup> and the offer of such transfer of ownership<sup>19</sup>. In *Donner* the CJEU decided that the distribution to the public is “*characterised by a series of acts going, at the very least, from the conclusion of a contract of sale to the performance thereof by delivery to a member of the public*”<sup>20</sup>.

This right is restricted to tangible originals or copies of works or other subject matter (rec. 27 InfoSoc Dir<sup>21</sup>). The exhaustion rule only applies to a particular copy, sold with the consent of the right holder. The classification of the making available right under the right of communication to the public, instead of the distribution right, entails that the exhaustion principle by virtue of art. 4(2) InfoSoc Dir does not apply to subsequent acts of communication of the work<sup>22</sup>.

communication to the public comes into play when content is transmitted in a way that a plurality of persons, who are not physically present where the activity of communications occurs, is placed in a position to access and enjoy copyright works, and this plurality of persons is qualified as a ‘public’. The author makes it clear that, in order to have distant communications with a public, what matters is the emission of the content signal and the making available of such content through networks, and not the actual and effective reception by the addressees.

15 See CJEU 14 July 2005, Case C-192/04, *Lagardère Active Broadcast v Société pour la perception de la rémunération équitable (SPRE) and Gesellschaft zur Verwertung von Leistungsschutzrechten mbH (GVL)*, Reports of Cases 2005 I-07199 (*Lagardère*); CJEU 7 December 2006, case nr. C-306/05, *SGAE v Rafael Hoteles*; CJEU 4 October 2011, joined cases C-403/08 and C-429/08, *Football Association Premier League Ltd and Others v QC Leisure and Others (C-403/08) and Karen Murphy v Media Protection Services Ltd (C-429/08)* (hereafter “*FAPL*” or “*Premier League*”); CJEU 13 October 2011, joined cases C-431/09 and C-432/09, *Airfield NV and Canal Digitaal BV v Belgische Vereniging van Auteurs, Componisten en Uitgevers CVBA (Sabam) (C-431/09) and Airfield NV v Agicoa Belgium BVBA (C-432/09) (Airfield)*; CJEU 15 March 2012, case C-135/10 *Consorzio Fonografici v Del Corso*; CJEU 15 March 2012, case C-162/10, *Phonographic Performance v Ireland (PPI)*; CJEU 7 March 2013, case C-607/11, *ITV Broadcasting e.a. v TVCatchup*.

16 See *Premier League*, par. 171.

17 We refer to the study on the exception for people with a disability for a discussion of the exhaustion rule.

18 CJEU 17 April 2008, case C-456/06, *Peek & Cloppenburg v Cassina*, par.36. Critical : VON LEWINSKI & WALTER, “*Information Society Directive*”, 994-995. According to these authors, forms of distribution without transfer of ownership should also be protected under this right, e.g. rental rights.

19 VON LEWINSKI & WALTER, “*Information Society Directive*”, 996, par. 11.4.14.

20 CJEU 21 June 2012, case C-5/11, *criminal proceedings against Titus Donner*, par. 26 (*Donner*).

21 VON LEWINSKI & WALTER, “*Information Society Directive*”, 993, par. 11.4.6.

22 It is specified that the rights of communication to the public and making available to the public are not exhausted by any act of communication or making available to the public (art. 3(3) Information Society Directive). According GOLDSTEIN and

The Court of justice came to another conclusion in *UsedSoft* in relation to computer programmes under the Computer Programs Directive (the Information Society Directive does not apply here)<sup>23</sup>.

The facts of this case can be summarised as follows. Oracle was a software company that held the copyrights to the developed computer programmes. The software (client-server software) was distributed by download via the Internet (from Oracle's website to the customer's computer). The "user rights" granted by a licence agreement included the right to store the computer programme on a server and to access it from a number of work stations by downloading it to the main memory of their work stations. The "user right" was meant exclusively for internal business purposes, for an unlimited period of time, it was non-exclusive, non-transferable and free of charge (*UsedSoft*, par. 23). The updates and patches could be downloaded from the Oracle site (as part of the maintenance agreement). Group licences were available for 25 users per licence. *UsedSoft* traded in used software licences. It acquired user licences from Oracle customers (or part of their licences) ("first acquirer"). It offers already used but "current" Oracle licences, for which the maintenance agreement was still in force (between the initial licence holder and Oracle). The *UsedSoft* customers ("second acquirers"), who did not already possess a copy, downloaded the software directly from Oracle's servers, after acquiring a "used" licence from *UsedSoft*. The *UsedSoft* customers who already possessed a copy but purchased an extension of the licence (for additional users) from *UsedSoft* could copy the program to the work posts of those additional users.

Generally, the question was whether the *UsedSoft* customers, who have acquired a used licence, infringe Oracle's copyright under the Computer Programs Directive (CPD)<sup>24</sup>, by using the software. The answer required the analysis of the exception for technical acts (applicable to the download and the reproductions of the software by the second acquirer) and of the exhaustion rule relating to the distribution right. We will focus on the latter part of the decision.

The Computer Programs Directive grants a right to control "*any form of distribution to the public, including the rental, of the original computer program or of copies thereof*" (art. 4 CPD). However, this distribution right is subject to exhaustion: "*the first sale in the Community of a copy of a program by the rightholder or with his consent shall exhaust the distribution right within the Community of that copy, with the exception of the right to control further rental of the program or a copy thereof*" (art. 4(2) CPD). The Court decided that the "*right of distribution of a copy of a computer program is exhausted if the copyright holder who has authorised, even free of charge, the downloading of that copy from the internet onto a data carrier has also conferred, in return for payment of a fee intended to enable him to obtain a remuneration corresponding to the economic value of the copy of the work of which he is the proprietor, a right to use that copy for an unlimited period*" (*UsedSoft*, par. 72).

The Court concluded that an offer for download of a computer programme, by the right holder, could in these circumstances lead to the exhaustion of the distribution right, taking a stance on some pertinent legal issues.

**First sale.** It was found that the authorised download of the copy and the licence, taken together as an indivisible whole (*UsedSoft*, par. 44), should be considered a "first sale", which could lead to exhaustion (art. 4(2) CPD). The term "sale" encompasses "*all forms of product marketing characterised by the grant of a right to use a copy of a computer program, for an unlimited period, in return for a payment of a fee designed to enable the copyright holder to obtain a remuneration corresponding to the economic value of the copy of the work*" (*UsedSoft* par. 49). It matters not that the copy of the program was acquired by download or in the shape of a DVD or a CD-ROM.

**Making available to the public.** It was argued that the offer for download is not an act of distribution but an act of making available, which is not subject to exhaustion. The Court ruled that the making available of copies of a

---

HUGENHOLTZ this principle of non-exhaustion entails that multiple licences are required when a work is offered online in more than one country of the European Union. See P. GOLDSTEIN & P.B. HUGENHOLTZ, *International Copyright*, Oxford, University Press, 2010, 330.

23 CJEU 3 July 2012, case C-128/11, *UsedSoft GmbH v Oracle International Corp* (*UsedSoft*).

24 Directive 2009/24/EC of the European Parliament and of the Council of 23 April 2009 on the legal protection of computer programs (Codified version), OJ L 111, 5 May 2009, p. 16–22 .

computer program does not constitute a “making available to the public” in the sense of art. 3(1) of the InfoSoc Directive (UsedSoft, par. 50). Therefore it cannot be derived (directly) that the exhaustion rule does not apply (as is the case for the making available right in the InfoSoc Directive). The legal grounds were that computer programs are dealt with in the Computer Programs Directive, left intact by the younger Information Society Directive and a *lex specialis* in relation to this latter directive (UsedSoft, par. 51).

**“Intangible” v “tangible” copies.** Furthermore it was defended that the distribution right and its exhaustion only apply with regard to tangible copies. According to the Court, the exhaustion rule applies to copies of the computer program, both in tangible or intangible form (UsedSoft par. 55). Moreover, the exhaustion extends to the copy of the computer program sold as corrected and updated by the copyright holder (UsedSoft, par. 68). The functionalities corrected, altered or added on the basis of a maintenance agreement (patches and updates) form an integral part of the originally downloaded copy and can be used for an unlimited period by the acquirer (UsedSoft, par. 67) even if the maintenance agreement is not renewed. The Court accepted that the distribution right was exhausted in respect of a copy that was not the specific copy, first sold with the consent of the right holder, but a “functional equivalent” instead (UsedSoft, par. 61). The exhaustion rule is not unlimited. It does not permit the first acquirer to divide the licence and sell the rights for the computer program exceeding the number accesses she needs (UsedSoft, par. 69). The exhaustion rule requires the first acquirer to make her own copy unusable. Similarly, the exhaustion rule does not extend to acquisition (secondary distribution) of additional licences.

The consequence of this interpretation was that the second acquirer could be considered as a “*lawful [acquirer] of a copy of a computer program within the meaning of Article 5(1) CPD and benefit from the right of reproduction provided for in that provision*” (UsedSoft, par. 88). The interpretation of the exhaustion rule of the distribution of computer programs thus affected the interpretation of the exception for technical acts performed by a lawful acquirer to enable the use of the computer program (art. 5(1) CPD).

While it is thus admitted that the distribution right may be subject to exhaustion in case of computer programs offered for download with the right holder’s consent, the Court was careful to emphasise that it reached this decision based on the Computer Programs Directive. It was stressed that this exhaustion rule constituted a *lex specialis* in relation to the Information Society Directive (UsedSoft, par. 51, 56). The Court gives reasons to assume that this reasoning cannot be transposed as such to other works, protected under the Information Society Directive.

It can be noted that a first case has been decided in Germany, on the offer for download of e-books and audio books<sup>25</sup>. The claimant in this case (a consumer organisation) opposed the restrictive user’s licence, which allowed only the personal use of the e-books and audio books but not the dissemination or the use by third parties. It relied *inter alia* on the UsedSoft ruling to demonstrate that the user’s rights under the licence were restricted to an excessive extent. The court rejected the claim. Its decision was based on notions of German property law and contract law but also copyright law. It was decided that the user’s licence did not result in an excessive disadvantage to the user with regard to *inter alia* the exhaustion of the distribution right in the German copyright act (UrhG).

The court stated that the exhaustion rule does not apply in case of online transmission of media items such as audio books, neither in case of a simple download, nor when the user has subsequently copied (incorporated) the work on a tangible object. In the opinion of the court, there was no act of distribution, since an online transmission does not entail any circulation of tangible copies. Instead, such transmission should be qualified as an act of making available to the public. The end-user alone makes a reproduction of the work, with the authorisation of the right holder by virtue of the use right. The exhaustion rule in

---

25 Landgericht Bielefeld 5 March 2013, case nr. 4 O 191/11, accessible via [http://www.boersenverein.de/sixcms/media.php/976/LG\\_Bielefeld\\_vom\\_05.03.13\\_Klage\\_Verbraucherzentralen.pdf](http://www.boersenverein.de/sixcms/media.php/976/LG_Bielefeld_vom_05.03.13_Klage_Verbraucherzentralen.pdf). See also E. LINKLATER, “Waiting for a lower court to rein in resale? You’d sooner herd cats”, The IPKat, 1 May 2013, accessible via <http://ipkitten.blogspot.be/2013/05/waiting-for-lower-court-to-reign-in.html>. It is reported that the decision would be appealed.

§17(II) UrhG is only applicable to the dissemination of specific tangible copies of the work and to the distribution right (§17(I) UrhG), but not to the reproduction right nor to the making available right.

The Court went on to consider the fate of tangible copies, which the user made after downloading the work. It decided that there is no exhaustion of the distribution right for such goods, even though the matter was considered controversial. The court referred to the discussions in relation to software, which is installed on a data support after an online transmission, and to the decisions of the courts of appeal dismissing exhaustion with regard to the reproduction right and forms of intangible dissemination of the work. The court found support in the Information Society Directive to reject exhaustion in case of online transmissions (art. 3(1) and art. 3(3) and rec. 29 InfoSoc Dir). The Court disregarded the CJEU's ruling in the *UsedSoft* case, considering that this decision was based solely on the Computer Programs Directive. While the European legislator had demonstrated its will to treat tangible and intangible forms of computer programs equally, this was not the case in the Information Society Directive that limits the exhaustion rule to tangible copies. The court finally noted that the Computer Programs Directive only applies to computer programs, not to music (MP3s) or books (e-books) that are only governed by the Information Society Directive. Furthermore, the *UsedSoft* decision cannot remedy that there is no exhaustion of the reproduction right. By conclusion, the *UsedSoft* ruling of the CJEU was not extended to the online transmission of e-books and audio books and the exhaustion rule could not be relied upon to invalidate the terms of the licence granting mere use rights and prohibiting the resale of the e-books and audio books.

In the USA a District Court of New York ruled in the same sense in a case opposing Capitol Records to ReDigi<sup>26</sup>. ReDigi was presented as a marketplace where users can re-sell the music tracks (in digital format) they have previously acquired and no longer want. ReDigi's service is used via software that verifies the legitimate source of the music track (e.g. iTunes) and makes sure that no copy of the track is kept after the resale<sup>27</sup>. The user who resells her music does not receive money in return but credits, which can only be spent via ReDigi. ReDigi earns a fee for every transaction.

The question was whether ReDigi's service constituted an infringement of the exclusive rights under copyright or if it benefited from any limitations of these rights, in particular the first sale doctrine. The Court decided that it did not: the operations via ReDigi's service required that right holders' consent.

The Court first assessed whether the rights of reproduction, and distribution were infringed<sup>28</sup>, the making available to the public not being protected as such. The Court found that ReDigi's service infringed the reproduction right<sup>29</sup>, even if the first copy at the seller's vanished when the track was "sold" to another user and, and at the end of the transaction, only one copy of the track subsisted. The Court also found that music tracks were sold via ReDigi's music and this resulted in an infringement of the distribution right. ReDigi's fair use defence was rejected and so was its first sale defence. Under the first sale defence, the exclusive right to control the distribution of a copy of a copyrighted work is exhausted once the copyright owner has placed it in the stream of commerce by selling it. It was argued that the digital music tracks were lawfully purchased via iTunes and that the purchaser was free to resell these tracks, protected by the first sale defence. The Court did not accept this defence: the first sale doctrine does not entitle the owner of a particular copy to make additional copies. The sending and storage of a copy on ReDigi's

---

26 US District Court Southern District of New York 30 March 2013, case No 12 Civ. 95 (RJS), accessible via <http://ia600800.us.archive.org/30/items/gov.uscourts.nysd.390216/gov.uscourts.nysd.390216.109.0.pdf>. It is reported that this decision would be appealed.

27 It may be observed that ReDigi cannot verify with certainty whether no other copies are kept, such as backup copies on other devices.

28 In the context of the summary proceedings the Court did not find an infringement of the performance right, which allegedly consisted in a 30 second preview of the tracks. The dispute on whether this preview was covered by a licence was not solved in this decision.

29 It should be mentioned that under American copyright formulates the reproduction right by reference to a certain subject matter (« sound recording ») and a certain support (« phonorecord ») (17USC §106(1)). The reproduction right in the Information Society Directive does not contain such precise indications.



server entailed the making of further copies, not the transfer of the “particular copy” on the user’s computer. In ReDigi’s system, and given the nature of digital technology, the copy that the user downloaded from iTunes was not the same copy as the one re-sold via ReDigi. Because the additional copies were infringing, their further distribution was also infringing: first sale defence did not protect the distribution of Capitol Record’s tracks by ReDigi, since the reproductions were not lawfully made. The Court added, for clarity’s sake, that the first sale defence was thus restricted to the distribution of material items, put in the stream of commerce. The Court refused to extend this defence to new forms of online exploitation, considering that such required an explicit policy stance and a legislative intervention.

In summary, the US court decided that a platform for reselling digital music tracks, which had been lawfully acquired, required the right holder’s consent. Although the US copyright law does not provide a right titled “making available to the public” and online transmissions of downloads are covered under the distribution right, the first sale did not lead to an exhaustion of the distribution right in favour of the first acquirer who wishes to resell her lawfully acquired copy. The first sale defence cannot offer protection for such service, which functions based on distinct reproductions rather than the redistribution of a particular material object.

**In summary**, we have placed the right of making available in the context of the Information Society Directive. On the one hand, the making available right is considered a species of the right of communication to the public, which entails that it shares the characteristic features of its umbrella right. The making available right should be distinguished from other species of the right of communication to the public, in particular the broadcasting right. Some forms of exploitation present features of both types of communication and cannot be qualified easily. On the other hand, the making available right should be distinguished from the distribution right, which is subject to the exhaustion rule. The ruling in *UsedSoft* cannot be extended directly to the making available of other works than computer programs, since it was issued under the Computer Programs Directive rather than the Information Society Directive.

We will continue our examination of the making available right in the decisions of the national courts of the Member States. We will discuss the following elements found in the description of the right in the Information Society Directive:

- Making available
- To the public
- On demand accessibility (time and place)

Hereafter it will be examined how these components have been clarified in the European and national legal orders.

## **b) Making available**

The right of making available to the public protects the act of making a work (or other protected subject matter) available for interactive on demand transmissions (rec. 25 InfoSoc Directive).

This right was designed to offer protection against the exploitation of works via computer networks (in particular the Web but other applications are covered as well). The typical scheme is the following: the “content” (protected works, often protected performances, phonograms or films) is stored (hosted) on a server (or a computer performing that function) to which users have access via a network and another device (client). The transmissions are technically similar to private communications (e.g. telephone communications or e-mail correspondence). To remove all doubt on the protection of interactive forms of exploitation, this right covers the fact that protected subject matter is offered to a public that is larger than the addressee of a “private” communication, even if it is followed by a one-to-one transmission.

**Starting point.** This right protects the “availability” of the work for consultation by a member of the public. The starting point is the stage preceding the transmission of the subject matter. It applies regardless of

whether the subject matter has actually been consulted<sup>30</sup>. It suffices that the public has the possibility to access the content, even if no one uses this possibility<sup>31</sup>.

**Publication v Hyperlinking.** In some cases this is fairly straightforward. A Dutch court was seized by a journalist whose articles had been published on several websites without his permission<sup>32</sup>. The website owner did not dispute that a copyright infringement had taken place but he did challenge the modalities of the infringement. In particular he asserted that the publication on distinct websites did not amount to distinct acts of communication (although it was not clear whether the websites used the same underlying databases and servers). The Court decided that the publication of the articles on each independent website amounted to a distinct act of communication to the public (*openbaarmaking*), especially since the intervention was more far-reaching than merely providing a hyperlink or a deeplink to another website. This “making available” (*beschikbaarstelling*) should be considered a separate infringement. By contrast, mere “surface links” (which lead visitors of a certain domain name immediately to another website) did not constitute a distinct act of making available from the publication on the website to which the link leads.

This decision could suggest that the practice of embedding content in a different environment (e.g. another website or another media space such as a social networking space) could be seen as an additional act of making available, but it is not conclusive given the circumstances that the Court explicitly mentioned that the user did more than just adding a hyperlink and that the common source of the websites was not established<sup>33</sup>.

In another Dutch case, it was decided that an act of communication to the public (*openbaarmaking*) of a number of educational works was performed, when the owner of a website (a teacher) provided hyperlinks to the servers where these works were stored<sup>34</sup>. The website owner’s role went further than the mere provision of hyperlinks, since it appeared from the publishers’ tests that the website owner had stored the works on the server and controlled whether the works remained available. The combination of the control over the server and the publication of the hyperlinks giving access to the works constituted an infringement of the publishers’ exclusive rights. The Court of appeal of Amsterdam considered that it was not proven that the teacher had published the textbooks on the Internet nor that he had taken special measures to allow third parties to access these, hence an act of communication to the public could not be found. The Court of appeal did however find a wrongful act and confirmed the decision of the first court<sup>35</sup>.

Meanwhile a question on hyperlinking has been submitted to the CJEU for a preliminary ruling<sup>36</sup>. The Swedish Supreme Court asked, broadly speaking, whether providing a hyperlink to a work constitutes a communication to the public, if it matters whether access is restricted or not, if a distinction should be

---

30 S. VON LEWINSKI & M. M. WALTER, “Information Society Directive”, 983, par. 11.3.30; B. LINDNER, “The WIPO Treaties”, 19.

31 Similarly, in *Rafael Hoteles*, the CJEU has ruled that “it is sufficient that the work is made available to the public in such a way that the persons forming that public may access it”. In relation to the installation of television set in hotel rooms, the Court declared that it is not decisive that customers who have not switched on the television have not actually had access to the works (*Rafael Hoteles*, par. 43). The use of the term “making available to the public” is unfortunate in this context, since the transmission of a broadcast to individual hotel rooms was at stake.

32 Arrondissementsrechtbank Haarlem 22 March 2006, *Mom v VNU*, AMI 2006, 4, 136-139, note KOELMAN.

33 See on the subject of framing and other contextual links : A. STROWEL & V. HANLEY, “Secondary liability for copyright infringement with regard to hyperlinks”, in A. STROWEL (ed), *Peer-to-peer file sharing and secondary liability in copyright law*, Cheltenham, Edward Elgar, 2009, 81.

34 Rb Haarlem 17 August 2011, case nr 173726 / HA ZA 10-1325, accessible via <http://ie-forum.nl/index.php?//Onlosmakelijk+daaraan+verbonden+antwoorden/////28941/>.

35 Court of appeal of Amsterdam 15 January 2013 (case nr. 200.095.838/01), accessible via <http://ie-forum.nl/index.php?//Eenvoudige+hyperlink+naar+antwoordboeken+en+uitwerkingen+onrechtmatig/////31097/> and [www.rechtspraak.nl](http://www.rechtspraak.nl).

36 Reference for a preliminary ruling from the Svea hovrätt (Sweden) lodged on 18 October 2012 - Nils Svensson, Sten Sjögren, Madelaine Sahlman, Pia Gadd v *Retriever Sverige AB*, case C-466/12 (Svensson).

made between a regular hyperlink and some type of embedded link and if the Member States are allowed to give a wider protection under the right of communication to the public<sup>37</sup>.

The “European Copyright Society”, consisting of independent copyright scholars, has issued an opinion on the questions referred in the Svensson case<sup>38</sup>. It was defended that hyperlinking in general should not be considered an act of communication to the public. This conclusion was reached on several grounds. Firstly, it was contended that the right of communication to the public requires a transmission that is absent when merely a hyperlink is provided. It is merely a location tool, but exists independently from the actual availability of the work. Secondly, the communication should address a public or a “new” public. The hyperlink does not extend the public of the work, published online: those who had access to the web page will still have access, those who did not have access (e.g. absent the payment of a fee) will not gain access through the hyperlink.

Another preliminary question was submitted by the Swedish Supreme Court in the case opposing C More Entertainment AB to Linus Sandberg. On his website, Mr Sandberg had linked to a website where C More Entertainment webcasted hockey matches (this website could not be found on the web and was protected by a paywall). The question was asked whether the defendant performed an act of communication to the public by linking to C More Entertainment’s website<sup>39</sup>.

**Cloud services.** With the increasing use of “cloud services” the question arises which element is decisive for finding an act of making a work available to the public. These services allow their users to store any content, including copyright protected material, online, on the service provider’s servers. The user has access to its content via the hyperlink that the service provider creates and he can use this service as an online equivalent of storing (personal) files on a local disk (having access at any time and at any location without having to synchronise files on various media). However, the user can also share the link with other people and consequently grant access to the stored content to a potentially large number of visitors.

37 Questions referred :

If anyone other than the holder of copyright in a certain work supplies a clickable link to the work on his website, does that constitute communication to the public within the meaning of Article 3(1) of Directive 2001/29/EC of the European Parliament and of the Council of 22 May 2001 on the harmonisation of certain aspects of copyright and related rights in the information society?

Is the assessment under question 1 affected if the work to which the link refers is on a website on the Internet which can be accessed by anyone without restrictions or if access is restricted in some way?

When making the assessment under question 1, should any distinction be drawn between a case where the work, after the user has clicked on the link, is shown on another website and one where the work, after the user has clicked on the link, is shown in such a way as to give the impression that it is appearing on the same website?

Is it possible for a Member State to give wider protection to authors' exclusive right by enabling 'communication to the public' to cover a greater range of acts than provided for in Article 3(1) of Directive 2001/29/EC of the European Parliament and of the Council of 22 May 2001 on the harmonisation of certain aspects of copyright and related rights in the information society?

38 EUROPEAN COPYRIGHT SOCIETY, Opinion on the reference to the CJEU in case C-466/12 Svensson, 15 February 2013, accessible via [http://www.ivir.nl/news/European\\_Copyright\\_Society\\_Opinion\\_on\\_Svensson.pdf](http://www.ivir.nl/news/European_Copyright_Society_Opinion_on_Svensson.pdf).

39 Request for a preliminary ruling from the Högsta domstolen (Sweden) lodged on 22 May 2013, Case C-279/13, C More Entertainment AB v Linus Sandberg. The following questions were referred:

Does the expression communication to the public, within the meaning of Article 3(1) 1 of the Information Society Directive, include measures to make available on a website open to the public a clickable link to a work which is broadcast by the holder of the copyright in that work?

Is the manner in which the linking is done relevant to the answer to question 1?

Is it relevant if the access to the work to which the linking is done is in any way restricted?

May the Member States give wider protection to the exclusive right of rightholders by enabling 'communication to the public' to cover a greater range of acts than provided for in Article 3(1) of the Information Society Directive?

May the Member States give wider protection to the exclusive right of authors by enabling 'communication to the public' to cover a greater range of acts than provided for in Article 3(1) of the Information Society Directive?

See also “Mededeling aan het publiek bij aanklikbare link op toegankelijke site”, IE Forum, IEF 12808, 27 June 2013, via <http://ie-forum.nl/?/////12808>.

While the Oberlandsgericht Hamburg had decided in 2008 that the mere upload of protected subject matter to a “cloud service”, such as Rapidshare, amounted to an act of making available, it has changed its position in 2012<sup>40</sup>. It recognised that these cloud services meet users’ changed information needs (i.e. access to their personal files at any time and at any place due to increased mobility) and are not necessarily used to share works with a multitude of other viewers. The mere upload to the “cloud service” is no longer decisive: an act of making available is performed at the earliest at the moment when the links to the content are shared via the Internet with third parties, as a part of a download link collection<sup>41</sup>.

A Dutch court of first instance issued a decision on the use of a similar service<sup>42</sup>. A photographer had made a photo series of a Dutch celebrity for the magazine Playboy. Before the series was published in the magazine, the news and gossip website GeenStijl had published hyperlinks to copyright protected nude pictures, stored at two back-up services. Publishing houses Sanoma and Playboy and the model took legal action against GeenStijl and claimed infringement of the right of communication to the public, in particular the making available right. GeenStijl defended that the mere publication of a hyperlink does not amount to an act of making available to the public. The Court put forward three relevant criteria: a certain “intervention”, a (new) public and a profitable intent. Firstly, the Court found that GeenStijl had indeed intervened in a relevant way. The Court acknowledged that in principle hyperlinking by itself does not amount to an act of communication to the public. In this case, however, the photos were available on a hosting and sharing site but the public could not find them (by means of a search engine) unless they had the exact URL. By publishing the hyperlink on its website, GeenStijl had imparted the photos to its own public of 230.000 visitors per day. The Court attributed that public accessibility to the publication of the URL on GeenStijl’s website, rather than to the fact that they were hosted on a server. It mattered not that GeenStijl could not exert any control over the availability of the photos. Moreover, it is apparent from the posts on the GeenStijl website that it indeed had the intention of making the pictures available to the public. Secondly, it was verified whether a “communication to the public” must address a different public than the one aimed at in the original communication, i.e. a “new public”. The court found that the visitors of the GeenStijl website was indeed a new public by comparison to the circle of people that had had access so far – which could not be seen as a public or at most as a very small public. Thirdly, the Court found that GeenStijl had commercial intent by the publication of the URL. The aim was to attract visitors to its website and it was established that the posts in which the URLs were communicated were among the most popular of that year.

**Not mere provision of physical facilities.** The making available right is further shaped by a “negative” delineation, as the “*mere provision of physical facilities for enabling or making a communication*” is not sufficient to be qualified as an act of making available (rec. 27 Information Society Directive). In the basic proposal of what would become the WIPO Copyright Treaty (WCT), the right of communication to the public as suggested by the European Community was taken over. It was considered that “*the relevant act is the making available of the work by providing access to it. What counts is the initial act of making the work available, not the mere provision of server space, communication connections, or facilities for the carriage and routing of signals*” (note 10.10)<sup>43</sup>.

Yet the providers of such facilities are often involved in cases regarding the unauthorised sharing of protected materials. A number of decisions in several European jurisdictions have been issued on peer-to-peer file sharing services. In the most recent cases, the right holders focus rather on the intermediaries (the platform or software providers) than on the users who actually share the protected

---

40 A. SCHNEIDER, “OLG Hamburg: Die Rapidshare-Entscheidung, ein Meilenstein?”, Telemedicus, 29 March 2012, retrieved via <http://tlmd.in/a/2229>.

41 Press communication “Urheberrechtswidrige Downloads: Oberlandesgericht Hamburg entscheidet über Prüf- und Handlungspflichten des Online-Speicher-Dienstes „RapidShare“, 15 March 2012, <http://justiz.hamburg.de/presseerklarungen/3334434/pressemeldung-2012-03-15-olg.html> in relation to the OLG Hamburg’s decision of 14 March 2012, Az. 5 U 87/09.

42 Rb. Amsterdam 12 September 2012, Sanoma Media, Playboy Enterprises International and X v GS Media (GeenStijl), accessible via [www.iept.nl](http://www.iept.nl).

43 Available at [http://www.wipo.int/edocs/mdocs/diplconf/en/cmrn\\_dc/cmrn\\_dc\\_4.pdf](http://www.wipo.int/edocs/mdocs/diplconf/en/cmrn_dc/cmrn_dc_4.pdf).

materials. Where these intermediaries are found responsible for the unauthorised exchanges, it is mostly considered that the users perform acts of making available to the public and the intermediaries are held responsible for these infringements based on general liability rules.

In the case “Mininova”, a Dutch court decided in this sense that the provider of a BitTorrent platform (Mininova) did not perform any act of making protected material available to the public<sup>44</sup>, since it merely offered a platform via which users could share “torrents” with other users, i.e. information on the location of files (possibly) containing copyright protected material. This information is by itself not protected under copyright and the service provider did not store the protected files (which were exchanged directly between the users). By reference to the agreed statement on art. 8 of the 1996 WIPO Copyright Treaty<sup>45</sup>, the Court considered that the service provider merely facilitated the exchange of files between its users and therefore no direct infringement of the making available right was made. Nevertheless, the service was considered unlawful under the general liability regime.

A similar verdict was reached in a British version of the “The Pirate Bay” cases<sup>46</sup>. The High Court found that the users of The Pirate Bay (not the provider of The Pirate Bay in this case) performed acts of copying, communication to the public and making available. It was found, firstly, that the users communicated the recordings by electronic transmission, since “*they make the recordings available by electronic transmission in such a way that members of the public may access the recordings from a place and at a time individually chosen by them within section 20(2)(b)*”. Secondly, a new public was addressed, i.e. a public which was not taken into account by the right holders when the distribution of recordings was authorised (i.e. the purchasers of copies from authorised sources), according to the test laid down by the CJEU in “SGAE”, “Premier League” and “Airfield”. It seems that the slightly different wording of the making available right in the British CPDA to the InfoSoc Directive has not prevented the qualification of “uploading” into a peer-to-peer network as an act of making available to the public<sup>47</sup>.

Although the servers of The Pirate Bay were located outside the UK, the Court did not consider it necessary to determine where the restricted act took place (emission theory v transmission theory). Instead, it focused on the place where the users of The Pirate Bay were located, i.e. the users who allow copies of a sound recording on their computers to be uploaded to the “swarm”. Since UK users are involved in both acts of uploading and downloading, it was held immaterial whether the act of communication to the public is committed at the place of origination or the place of reception<sup>48</sup>. A similar

---

44 Rb. Utrecht 26 August 2009, LJN BJ6008; B9 8127, Brein v Mininova, AMI 2009, 215-217. The Court of appeal of Amsterdam ruled in the same sense on a specialised search engines for MP3s that the search engine provider performed a wrongful act under the general rules of civil liability. The first judge had decided that it did not perform any acts of communication to the public (unlike its users), but the Court of appeal did not take a stance on this point: Gerechtshof Amsterdam 15 June 2006, Rolnummer 1157/04, “ZoekMP3”, AMI 2006/5, 173. In this sense also Voorzieningenrechter Rb Amsterdam 22 oktober 2009, Neij c.s. v Brein, AMI 2010/1, 18-24, note HUGENHOLTZ. The Court of appeal of ‘s Gravenhage rejected a criminal action against such facilitator as non-admissible: Gerechtshof ‘s Gravenhage 22 December 2010, “eDonkey”, AMI 2011/5, 183-186, note M.J.A. DUKER. An injunction was granted against a website owner which offered a sports programme guide and links to live streams via P2P groups, not based on a direct infringement of the making available right but the wrongful facilitating of such infringing exchanges: Vz. Rb. Den Haag 22 March 2011, KNVB and UFA Sports c.s. v MyP2P Holding, AMI 2011/3, 108.

45 “It is understood that the mere provision of physical facilities for enabling or making a communication does not in itself amount to communication within the meaning of this Treaty or the Berne Convention. It is further understood that nothing in Article 8 precludes a Contracting Party from applying Article 11bis(2)”.

46 UK High Court of Justice 20 February 2012, *Dramatico Entertainment Limited e.a. v British Sky Broadcasting Limited e.a.* EWHC. (2012), retrieved from <http://www.bailii.org/ew/cases/EWHC/Ch/2012/268.html>.

47 Whereas the InfoSoc Directive covers the act of making available to the public by wire or wireless means, the CDPA protects « the making available to the public of the work by electronic transmission in such a way that members of the public may access it from a place and at a time individually chosen by them ». It was feared that this expression would exclude acts of uploading, since the uploader « does not transmit material when they upload material onto the hard drive of their computers and store in shared folders ». See H. KRISTJAN LARUSSON. (2009). Uncertainty in the Scope of Copyright: The Case of Illegal File-Sharing in the UK. E.I.P.R., 31(3), 126.

48 See par. 68 of the decision.

conclusion was reached in *EMI v BSKyB*<sup>49</sup>. It was considered that the users of file sharing websites, who select a torrent file and download it without the author's consent, copies the content in the files and thus infringes copyright. It was established that users of these websites have accounts with British access providers and are therefore in the UK. The Court concluded that UK users of the torrent sites infringed the copyrights (reproduction right). With regard to the right of communication to the public, the Court considered that the torrent site users who upload content do communicate works to the public since they make the recordings available by electronic transmission, via the torrent websites, in such a way that members of the public may access the recordings from a place and at a time individually chosen by those members of the public.

In another case, the UK High Court of Justice found that the provider of Usenet service "Newzbin" itself was guilty of making protected works belonging to major film studios available to the public<sup>50</sup>. Newzbin not only offered a technical cataloguing and indexing system that enabled its paying premium members to identify films and download them, but it had also set up a sophisticated editorial system. This led the Court to decide that Newzbin made the films available to a new audience, consisting of its premium members (by reference to the CJEU's ruling in "Rafael Hoteles"). Furthermore, the premium members themselves considered that Newzbin offered the films via the Newzbin index. The Court concluded that the service provider was not remotely passive, its actions exceeded the simple linking to a film, made available by a third party.

It was reported that, after this ruling, Newzbin went into voluntary liquidation and the original website ceased operating. A successor website began operating from the same address, by unknown individuals, and its operation was moved offshore, outside the court's jurisdiction<sup>51</sup>. The right holders then turned against the access provider BT, which was ordered to block its users from accessing the illegal file sharing website.

**Endpoint.** While the starting point of this exclusive right is undisputed, it is not clear how far the making available right extends and, in particular, whether the transmission following the availability is part of the restricted act. Some consider that this right covers "*the whole act of communication, including the upload and the entire transmission to the download*"<sup>52</sup>. Others are not so sure<sup>53</sup>. The legal provisions do not specify that the making available right extends to the transmission of the work. Furthermore, it is often stated that the making available *per se* is protected, regardless of whether the work is actually accessed (and therefore transmitted). A possibility is that the transmission alone is not protected or that it may be protected as a distinct act of communication.

---

49 UK High Court of Justice 28 February 2013 [2013] EWHC 379 (Ch), *EMI and others v British Sky Broadcasting and others*, nrs. 24 and 38 et s.

50 UK High Court of Justice 29 March 2010, *Twentieth Century Fox Film Corporation & Anor v Newzbin Ltd.*, EWHC 2010, retrieved from <http://www.bailii.org/ew/cases/EWHC/Ch/2010/608.html>. This decision was followed by an action against the internet service provider BT in UK High Court 28 July 2011, [2011] EWHC 1981 (Ch), accessible via <http://www.bailii.org/ew/cases/EWHC/Ch/2011/1981.html>. See also "Son of NewzBin: another victory for the film-makers", *The IPKat*, 28 July 2011, accessible via <http://ipkitten.blogspot.be/2011/07/son-of-newzbin-another-victory-for-film.html>.

51 A. MOIR & D. PEARCE, "High Court orders BT to block its customers from accessing an unlawful file sharing site: *Twentieth Century Fox Film Corp v British Telecommunications Plc.*", *E.I.P.R.* 2, 33(11), 736-738.

52 A. PEUKERT, "Territoriality and Extraterritoriality in Intellectual Property Law". in G. HANDL & J. ZEKOLL (Eds.), *Beyond Territoriality: Transnational Legal Authority in an Age of Globalization* Queen Mary Studies in International Law, Brill Academic Publishing, Leiden/Boston, 2011, retrieved from <http://ssrn.com/abstract=1592263>, p. 17. In this sense also J. REINBOTHE & S. VON LEWINSKI, *The WIPO Treaties 1996*, London, Butterworths, 2002, 108.

53 A. OHLY, "Economic rights" in E. DERCLAYE (ed.), *Research Handbook on the Future of EU Copyright*, Cheltenham, Edward Elgar, 2009, 225; M. SCHLESINGER, "Legal issues in peer-to-peer file sharing, focusing on the making available right" in A. STROWEL (ed.), *Peer-to-peer file sharing and secondary liability in copyright law*, Cheltenham, Edward Elgar, 2009, 47, 68. S. VON LEWINSKI & M. M. WALTER, "Information Society Directive, 983, par. 11.3.30 (where it is indicated in footnote 145 that the question is controversial, with reference to J. REINBOTHE & S. VON LEWINSKI, *The WIPO Treaties 1996*, art. 8 nr. 21

This issue was one of the questions (indirectly) considered in the “Sportradar” cases<sup>54</sup>. Football Dataco and others were the operators of a football database, Football Live, and claimed that the defendants under the name Sportradar (one registered in Germany, the other one in Switzerland) infringed their exclusive database rights, by offering football data services including data relating to British football matches. In order to determine its jurisdiction in this case, the Court had to consider where the acts of extraction and re-utilisation took place. With respect of the re-utilisation of the database, the question was whether the act took place where server is situated, where the public are or in both locations.

The Database Directive defines “extraction” as “*the permanent or temporary transfer of all or a substantial part of the contents of a database to another medium by any means or in any form*” and “re-utilisation” as “*any form of making available to the public all or a substantial part of the contents of a database by the distribution of copies, by renting, by on-line or other forms of transmission*” (art. 7(2) DBD).

The first Court answered this question via the making available right, considering all arguments pro and contra the emission and reception theories. The High Court came to the conclusion “*that the better view is that the act of making available to the public by online transmission is committed and committed only where the transmission takes place. It is true that the placing of data on a server in one state can make the data available to the public of another state but that does not mean that the party who has made the data available has committed the act of making available by transmission in the State of reception. I consider that the better construction of the provisions is that the act only occurs in the state of transmission*”. The Court of appeal did not follow the first judge on this point. After having considered (and refuted or nuanced) the arguments in favour of the transmission theory, the Court of appeal referred the matter to the CJEU (in respect of the part of the case relating to the direct liability for breach of database rights, but not in respect of the issues of joint-tortfeasorship)<sup>55</sup>. The Advocate General and the Court treated the quite specific question of the Court of appeal in two steps. First, the operation of Sportradar of sending data to the user, at her request, was qualified as an act of reutilisation. Then, this act was localised on the territory of the Member States (cf. *infra sub* Part I,B,3, b).

The Advocate General considered the act of sending to a user’s computer, upon her request, information obtained from a protected database an “*act forming a necessary constituent part of a process of making available to the public, which [...] constitutes a re-utilisation*” (opinion, par. 41). Reutilisation should be considered as “*a generally complex act made up of acts needed to produce the effect of making available, which, in the language of the Directive itself, comprises reutilisation*” (opinion, par. 42). The act of “sending” was considered one of the necessary component parts of that complex act and consequently shared the classification of the complex act, i.e. a reutilisation of data from a protected database (par. 42, 47). Agreeing with the Advocate-General on this point, the Court defined the restricted act as “*extending to any act, not authorised by the maker of the database protected by the sui generis right, of distribution to the public of the whole or part of the contents of the database*” and covering an act “*in which a person sends, by means of his web server, to another person’s computer, at that person’s request, data*

54 UK High Court of Justice Chancery Division 17 November 2010, Football Dataco e.a. v Sportradar e.a., EWHC 2010, 2911, retrieved from <http://www.bailii.org/ew/cases/EWHC/Ch/2010/2911.html>; High Court of Justice, Court of appeal 29 March 2011, Football Dataco e.a. v Sportradar e.a., EWCA 2011, civ 330, retrieved from <http://www.bailii.org/ew/cases/EWCA/Civ/2011/330.html>; CJEU 18 October 2012, case C-173/11, Football Dataco Ltd, Scottish Premier League Ltd, Scottish Football League, PA Sport UK Ltd v Sportradar GmbH, Sportradar AG ; Court of appeal 6 February 2013, case Nos A3/2012/1349, 1352, 1364, 1366, Football Dataco Ltd and others and Stan James and others, Sportradar GmbH and another, [2013]EWCA Civ 27.

55 Reference for a preliminary ruling from Court of Appeal (England & Wales) (Civil Division) (United Kingdom) made on 8 April 2011 - Football Dataco Ltd, Scottish Premier League Ltd, Scottish Football League, PA Sport UK Ltd v Sportradar GmbH (a company registered in Germany), Sportradar (a company registered in Switzerland), Case C-173/11:

Where a party uploads data from a database protected by sui generis right under Directive 96/9/EC1 (“the Database Directive”) onto that party’s web server located in member state A and in response to requests from a user in another member state B the web server sends such data to the user’s computer so that the data is stored in the memory of that computer and displayed on its screen

a) is the act of sending the data an act of “extraction” or “re-utilisation” by that party?

b) does any act of extraction and/or re-utilisation by that party occur

(i) in A only

(ii) in B only or

(iii) in both A and B

*previously extracted from the content of a database protected by the sui generis right. By such a sending, that data is made available to a member of the public”* (Sportradar, par. 20-21).

This decision sheds some light on the scope of the reutilisation right, which in this case was applied to a technical scheme comparable to those protected under the making available right. The act of sending the data, at the individual request of a user, to that user was considered a necessary act protected under the reutilisation right. Considering that the act of reutilisation can be localised at least in the Member State where the public was targeted, it was not necessary to define the end-point of the reutilisation.

Remarkably, the Court of appeal issued its decision after the CJEU's ruling without applying the reutilisation right. It established that it had jurisdiction to rule on the primary liability of Sportradar and found an infringement of the extraction right, protecting the Football Live databases.

**Download v streaming.** Also, it does not matter in which form the works are made available: they can be offered for download (copy at the user's end) or simply made perceptible to the user by streaming<sup>56</sup>.

The Criminal Court of Stuttgart decided on appeal a case relating to an on demand streaming service for music<sup>57</sup>. It found that the service provider made music recordings available to the public: all conditions were met, since each user had access, at any time, at any place (with internet access), to the songs and albums and could hear these as often and in any compilation at her convenience. The condition of a public was met as well, since the service was meant for several members of the public and no personal connection existed between the 26.000 users of the service. The circumstance that a streaming service (rather than a downloading service) was offered did not alter this qualification. It mattered not that the user was not able to make a permanent copy of the transmitted songs: the making available right does not require that the user makes a new fixation of the recording (not even for the phonogram producer's right). The purpose of the protection was said to safeguard the exploitation of the recordings: if the recordings are available (in return for a fairly modest price) so the user can listen to them at any time and however often he desires, then a reproduction is of course no longer required for the exploitation of the recordings to suffer from it.

### c) To the public

**Public.** The “public” is not defined in the Directive but it should be understood as not being present<sup>58</sup> at the place where the act of making available originates (rec. 24 Information Society Directive). The use of the notion “public” indicates however that merely “private” communications are excluded<sup>59</sup>. As long as the work is made accessible to people or a group of people who cannot be qualified as a “public”, there is no restricted act.

This requirement that a “public” should have access to the work, has proven decisive in two cases on online hosting services (*supra sub b*). In *RapidShare*, the Court of appeal of Hamburg court found that the upload of copyright works to a cloud service alone is not sufficient to find an infringement, it should also be demonstrated that it was accessible in the cloud to a public<sup>60</sup>. In *GeenStijl* the Court of first instance of Amsterdam found an act of communication to the public when an online news and gossip

---

56 S. VON LEWINSKI & M. M. WALTER, “Information Society Directive”, 983, par. 11.3.31.

57 OLG Stuttgart 21 January 2008, Az. 2 WS 328/07; 2 Ws 328/2007, Telemedicus, available via <http://tlmd.in/u/488>.

58 See on this point : Premier League, par. 200 et s. and CJEU 24 November 2011, case C-283/10, *Circul Globus București* (Circ & Variete Globus București) v Uniunea Compozitorilor și Muzicologilor din România – Asociația pentru Drepturi de Autor (UCMR – ADA).

59 See note 10.12 of the Basic Proposal of the WCT.

60 Press communication “Urheberrechtswidrige Downloads: Oberlandesgericht Hamburg entscheidet über Prüf- und Handlungspflichten des Online-Speicher-Dienstes „RapidShare“, 15 March 2012, <http://justiz.hamburg.de/presseerklarungen/3334434/pressemeldung-2012-03-15-olg.html> in relation to the OLG Hamburg's decision of 14 March 2012, Az. 5 U 87/09.



website published the hyperlinks to a cloud service where nude pictures were stored that were previously not accessible to a public<sup>61</sup>.

The Court of Justice has interpreted the notion of “public” in several decisions. In *Lagardère*, the public was described as an “*indeterminate number of potential listeners*”, by reference to the *Mediakabel* decision<sup>62</sup>. When satellite signals can only be received by equipment available solely to professionals there is no broadcast in the sense of the SatCab Directive (*Lagardère*, par. 31-32). In *Rafael Hoteles*, the Court applied the same criterion (*indeterminate number of potential television viewers*”, *Rafael Hoteles*, par. 37) and found a new public, i.e. a “*public different from the public at which the original act of communication of the work is directed*” (*Rafael Hoteles*, par. 40). When a hotel owner makes it possible for hotel guests to watch television broadcasts in their rooms, a public can be found. The Court took into account the customers in the hotel rooms and customers in other areas of the hotel where televisions sets are installed and the circumstance that these hotel customers succeed each other quickly. A fairly large number of persons were involved, so they may be considered to be a public (*Rafael Hoteles*, par. 38).

In *Marco Del Corso*, the Court understood that this means making a work perceptible to “*persons in general, that is not restricted to specific individuals belonging to a private group*” (*Marco Del Corso*, par. 85). Furthermore, the Court interpreted the requirement of a “fairly large number of people” as being intended to indicate that the “*concept of public encompasses a certain de minimis threshold, which excludes from the concept groups of persons which are too small or insignificant*” (*Marco Del Corso*, par. 86). Moreover, the Court read in its previous decisions in *Rafael Hoteles* and *Premier League*, which took the profit-making nature of the communication into account, that “*the public which is the subject of the communication is both targeted by the user and receptive, in one way or another, to that communication, and not merely ‘caught’ by chance*” (*Marco Del Corso*, par. 91). Several criteria were listed, which were complementary, not autonomous and interdependent and which called for an individual assessment of each case. The Court found here that a dentist, who has the radio on in his private dental practice, does perform a deliberate intervention to make his patients listen to the broadcast programmes, but that “patients” generally form a very consistent group of persons, i.e. a determinate group of potential recipients – not “persons in general”. Also, the number of persons is insignificant, whether they are considered as the persons present in the practice at the same time or successively. Finally, the broadcast is not likely to have an impact on the income of the dentist (rise of the number of patients or higher prices).

In a judgment of the same day, the Court found that a hotel owner who makes broadcast programs accessible in hotel rooms does address a public, since the hotel guests constitute an indeterminate number of potential listeners, limited only by the capacity of the establishment, and therefore “persons in general” (PPI, par. 41). A fairly large number of persons may be reached this way. Finally, the guests are targeted and receptive (PPI, par. 42-43)<sup>63</sup>.

**New public.** In *Premier League*, a “new public” was found when a broadcast work is transmitted to a “*public which was not taken into account by the authors of the protected works when they authorised their use by the communication to the original public*” (*Premier League*, par. 197)<sup>64</sup>. When a pub owner “transmits” a broadcast to the customers present in that establishment, the Court found a new public in comparison to the public of the initial broadcast.

---

61 Rb. Amsterdam 12 September 2012, *Sanoma Media, Playboy Enterprises International and X v GS Media (GeenStijl)*, accessible via [ww.iept.nl](http://ww.iept.nl).

62 CJEU 2 June 2005, Case C-89/04, *Mediakabel BV v Commissariaat voor de Media*, Reports of Cases 2005 I-04891 (*Mediakabel*); CJEU 14 July 2005, Case C-192/04, *Lagardère*.

63 A similar question was asked in the reference for a preliminary ruling from the *Krajský soud v Plzni* (Czech Republic) lodged on 24 July 2012 - *Ochranný svaz autorský pro práva k dílům hudebním, o.s. (OSA) v Léčebné lázně Mariánské Lázně, a.s.*, case nr. C-351/12.

64 On a “new public”: see also *Airfield*.

In *TVCatchup*, however, broadcast television programmes were retransmitted via the Internet to people who qualified for access to the broadcasts, i.e. who had acquired a TV licence and who resided in the UK. In other words, the public who had access to the TV streams were exactly the public considered by the authors when they authorised the broadcast. The Court nuanced its previous decisions and decided that when a work is put to multiple uses, each transmission by a specific technical means must be individually authorised by the author and that a specific technical means different from the original communication technique is a communication to the public in the sense of the InfoSoc Directive (*TVCatchup*, par. 24, 26). Each transmission must be authorised individually and separately by the authors, “*given that each is made under specific technical conditions, using a different means of transmission for the protected works, and each is intended for a public*” (*TVCatchup*, par. 39). It is not necessary then to examine whether a “new public” can be found. Instead, the Court stated that the right of communication to the public covers a “*retransmission of works included in terrestrial broadcasts, where the retransmission is made by an organisation other than the original broadcaster, by means of an internet stream made available to the subscribers of that other organisation who may receive that retransmission by logging on to its server, even though those subscribers are within the area of reception of that terrestrial television broadcast and may lawfully receive the broadcast on a television receiver*” (*TVCatchup*, par. 40).

**Bit torrent.** A UK High Court applied these principles to the use of bit torrent file sharing sites<sup>65</sup>. It found that the users who upload content make the content available to the public and it found a “new public” as well. The users “*intervene, in full knowledge of the consequences of their actions, to give others access to the Claimants’ copyright works. The recordings are made available to all other users of the Websites, a large and indeterminate class of people, without having to purchase them from authorised sources*”<sup>66</sup>. The judge added that these users indirectly obtained a financial benefit, not because they make money out of uploading but because they anticipate that other users will reciprocate.

**Online video recorders.** The German Bundesgerichtshof has ruled in two cases on the making available right in relation to “online video recorders”<sup>67</sup>. In both cases, a broadcasting organisation (RTL and Sat1) claimed that the provider of an online video recording service (“Save.tv” and “Shift.tv”) infringed *inter alia* its making available right. These service providers made it possible for their customers to record free-to-air programmes via an electronic programme guide and to watch these programmes at a later time and at any place (provided there was an Internet connection). Technically, the programmes that the customers selected were stored on the provider’s hard disk but at a space exclusively attributed per customer. This amounted to a reproduction, performed by the person who made the material copy, which could be exempted if this person fulfilled all conditions for such exception (in particular for private use). The Supreme Court did not dispose of the information required to assess this *in concreto*. The Court of appeal of Dresden, upon referral from the BGH, decided that the user of the online video recorder makes the reproduction, not the service provider, and therefore this reproduction can qualify as a reproduction for private use<sup>68</sup>.

The Court found that no acts of making available to the public were made. It was for the lower court to verify whether the broadcast programmes were recorded and reproduced by the service provider (not the customers). If this were the case, then the service provider would make the recording available to its customers, since the programmes could be accessed at any time and at any place at the demand of the customers. This would suggest that the reproduction right and the making available right are applied cumulatively, not alternatively, at the source of the accessibility. However, the Court found that the

---

65 UK High Court, *EMI v BSKyB*, par. 40.

66 UK High Court, *EMI v BSKyB*, par. 40.

67 BGH 22 April 2009, I ZE 175/07, “Save.tv”; BGH, 22 April 2009, I ZR 216/06, “Shift.tv”, via [www.juris.bundesgerichtshof.de](http://www.juris.bundesgerichtshof.de). See also S. VON LEWINSKI, “Recent developments of German Authors’ Rights Law”, AM 2011/2, 164-165. The court to which the decision was referred has followed the BGH’s decision: OLG Dresden, 12 July 2011, case nr. 14 U 801/07, GRUR RR 2011, 413.

68 BGH 11 April 2013, I ZR 152/11, « Internet Videorecorder II », nr. 11 et s., accessible via <http://www.bundesgerichtshof.de>.

A. SCHNEIDER, “OLG Dresden klärt Rechtsstreit um Online-Videorekorder », *Telemedicus*, 15 July 2011, accessible via <http://www.telemedicus.info/article/2040-OLG-Dresden-klart-Rechtsstreit-um-Online-Videorekorder.html>.

recording was not available to the “public”, since only the customer who had ordered the recording of the programme had access to it. Interestingly, the Court rejected the argument that the customers, who have ordered the recording of the broadcast, can be collectively considered as a public. Moreover, it was considered that the service provider makes a “future offer” (rather than offer immediate access to protected works), in the sense that it engages to record future programmes and it will make that recording accessible to the individual customer (not a public). The Court of appeal of Dresden decided that there was no infringement of the making available right<sup>69</sup>. According to this Court, the broadcast programs were directly transmitted to the online video recorder of an individual customer and therefore it was no longer within its sphere of control and thus available to a public.

Another question was whether the transmission of the recorded broadcasts to the customers’ private storage spaces should be seen as a rebroadcast of the recorded programmes<sup>70</sup>. The Supreme Court decided that this transmission could indeed be considered a rebroadcast, but it did not decide whether this transmission reached a “public” – this was for the lower court to decide upon referral. The Court of appeal of Dresden found that this was the case: the signals were captured by means of an antenna and retransmitted simultaneously to the online video recorders of the customers. It was established that the retransmission was addressed to several members of the public, at least 100 independent users who were not connected by personal ties<sup>71</sup>.

Similarly, the Australian Federal Court decided that the provider of an online time-shifting service did not infringe the making available right<sup>72</sup>. In this case, the Australian Football League and the National Rugby League objected to a remote television recording service (“TV Now”), offered by telecommunication provider Optus (which had failed to obtain a licence for the broadcast of these sports matches). Its subscribers could record free-to-air programmes and play back the recordings via web browsers or mobile devices. Whenever a customer requested the recording of a programme, several copies were made (for each format available). The user could then watch the recording later, via streaming (time shifting). The Federal Court decided that it was not the service provider but its users who made the reproductions and that these could be covered under the time shifting exception in the Australian copyright legislation. Furthermore, when the customer replayed the recording, it was considered that the customer (not the service provider) performed an act of communication – but not to the public. Insofar as the recording was used only for private and domestic use and for watching or listening to it at a convenient time, the recordings were not communicated to a public. This decision was however reversed by the full Federal Court<sup>73</sup>.

In the United States, the Court of Appeals for the 2<sup>nd</sup> circuit treated a dispute related to the use of a standalone DVR proposed by an operator of cable television called Cablevision<sup>74</sup>. That system allowed Cablevision’s customers to record cable programmes on central hard drives housed and maintained by

---

69 OLG Dresden 12 juli 2011, case nr. 14 U 1071/6) as quoted in BGH 11 April 2013, I ZR 152/11, « Internet Videorecorder II », nr. 21-22.

70 The so-called “Senderecht” (§20 UrhG).

71 OLG Dresden 12 July 2011, case nr. 14 U 1071/6) as quoted in BGH 11 April 2013, I ZR 152/11, « Internet Videorecorder II », nr. 43.

72 Federal Court of Australia 1 February 2012, Singtel Optus Pty Ltd v National Rugby League Investments Pty Ltd (No 2) [2012] FCA 34, accessible via <http://www.austlii.edu.au/au/cases/cth/FCA/2012/34.html>.

73 Federal Court of Australia 27 April 2012, National Rugby League Investments Pty Limited v Singtel Optus Pty Ltd [2012] FCAFC 59, accessible via <http://www.austlii.edu.au/cgi-bin/sinodisp/au/cases/cth/FCAFC/2012/59.html>. The Court disagreed with the first judge on the point of who made the film, sound recording or copy of the television broadcast. Whereas the first court deemed the user of the service to be the maker, the full Federal Court disagreed and held Optus or Optus and its customer to be the maker of the copy. This ground sufficed to reverse the first court’s decision, the issue regarding the communication to the public was not dealt with. See also the discussion of this case in A. SPIES, “Internet streaming of TV broadcasts: your ‘one stop shop’ update on international copyright disputes”, Lexology, 20 May 2013, accessible via <http://www.lexology.com/library/detail.aspx?g=08ff7d51-1c40-4592-a275-1068fb0e5c02>.

74 US Court of Appeals for the second circuit 4 August 2008, Cartoon Network, LP v. CSC Holdings, Inc., 536 F.3d 121 (2d Cir. 2008), accessible via [http://www.ca2.uscourts.gov/decisions/isysquery/339edb6b-4e83-47b5-8caa-4864e5504e8f/1/doc/07-1480-cv\\_opn.pdf](http://www.ca2.uscourts.gov/decisions/isysquery/339edb6b-4e83-47b5-8caa-4864e5504e8f/1/doc/07-1480-cv_opn.pdf).

the cable company at a remote location. Similar to the German cases, the copies made were recorded on specific portions of Cablevision's hard disks dedicated to each customer. The customers could then receive playback of the programs they had recorded. This service was offered by Cablevision without specific licence from the content providers, who sued the cable operator for direct infringement to their exclusive rights. The Court of Appeals had to determine whether Cablevision or its customers were the authors of the infringing conduct. After having found "*two instances of volitional conduct in this case: Cablevision's conduct in designing, housing, and maintaining a system that exists only to produce a copy, and a customer's conduct in ordering that system to produce a copy of a specific program*", the Court considered that copies were made by the customer. It rejected Cablevision's direct liability because of its contribution to this reproduction. The Court also rejected Cablevision's liability based on the playback of the copies made by its customers, considering that it did not constitute a transmission to the public because "*each RS-DVR playback transmission is made to a single subscriber using a single unique copy produced by that subscriber*". It would be interesting to explore to which extent this element of volitional conduct could contribute to clarifying the making available right in the European copyright context.

The same court reached a similar decision in a case brought by several broadcasting services against Aereo, an Internet based streaming service that allows its users to watch broadcast shows live or to record them for future viewing<sup>75</sup>. Finally, a California federal district court judge has granted an injunction (tentative decision) against a similar service, named Aereokiller<sup>76</sup>. It seems the debate in the US is not over yet.

#### **d) On demand: access from a place and at a time individually chosen by the public**

**On demand.** The last element is the way the works are accessed: the members of the public may access the works from a place and at a time individually chosen by them. This formulation is meant to catch the forms of making a work available "by way of interactive on-demand transmissions" (rec. 25). These forms of communication allow the members of the public to decide themselves, individually, where and when to access the works. This covers cases where members of the public may have access to the works from different places and at different times<sup>77</sup>.

This does not mean that the work should be available without restrictions. The fact that the content provider has determined a window of availability (geographical scope and period of accessibility) does not alter the qualification as an act of making available.

This "interactive" element distinguishes the making available right from other, linear forms of communication (such as broadcasting)<sup>78</sup>. It should therefore not be understood in a technical sense, but refers to distinct forms of exploitation. As has been demonstrated in the 2007 study by IViR, "interactivity" is not an unequivocal feature: works can be distributed online at various degrees of interactivity<sup>79</sup>. Nevertheless the distinction has important legal consequences, especially in terms of right clearance and collective management.

75 US Court of appeals for the second circuit, 1 April 2013, WNET, Thirteen v. Aereo, Inc. 12-2786-cv, 12-2807-cv. See J.C. GINSBURG, "WNET v. Aereo: The Second Circuit Persists in Poor (Cable)Vision", The Media Institute, 23 April 2013, <http://www.mediainstitute.org/IPI/2013/042313.php>.

76 S.A. DAVIDSON, "California federal district court judge grants injunction against "Aereo" copycat service, questions reasoning of Second Circuit's decision in the cablevision remote-storage/DVR case", Lexology, 2 January 2013, accessible via <http://www.lexology.com/library/detail.aspx?g=e7fc8855-c4cb-4a7a-95d3-b66d305f02fe>.

77 Note 10.11 Basic Proposal WCT.

78 Note 10.12 Basic Proposal WCT.

79 IViR Report The Recasting of Copyright & Related Rights for the Knowledge Economy. 56.; IViR Study on the Implementation and Effect of Directive 2001/29, 28. See also B. LINDNER, "The WIPO Treaties", 19; H. HAOUIDE, « Diffusion en continu sur Internet. Le webcasting constitue-t-il une radiodiffusion au sens de l'article 41 de la LDA ? », A&M 2006/1, 10-20;

The Court of Justice contrasted the broadcasting to the making available of phonograms in *Marco Del Corso*. The referring court was asked to decide whether a dentist was under the obligation to pay an equitable remuneration to the phonogram producer for the broadcasts he received in his private dental practice. Before answering the questions, the Court observed that a broadcasting, free of charge, of phonograms within a private dental practice engaged in professional economic activity for the benefit of patients of this practice and enjoyed by them without any active choice on their part could not be qualified as an act of making available, which supposes an interactive on demand transmission (Marco Del Corso, par. 57-60). The Court then reformulated the question and consider it in the framework of Directive 92/100.. It can be derived that the classifications as “broadcasting” or “making available” are mutually exclusive. The transmission without any active choice on the part of listeners indicates a broadcast, whereas the interactive, on demand transmission suggests an act of making available to the public.

As indicated previously, the Criminal Court of Stuttgart clarified, on appeal, the criteria to distinguish the making available and the broadcasting of protected subject matter in a case on a service offering music streaming on demand<sup>80</sup>. Via this service, users could access music (songs or albums) on demand, from a music archive with search function, they could even compose a personal radio programme and listen to it whenever and from wherever they wanted. According to the Court, this service was not a broadcasting service, but an on demand service. The circumstance that users were able to choose the time of access to the recordings was decisive. Under the broadcasting right, the time of transmission and the chronological order of the parts of a programme are determined by the sender/broadcaster, which transmits the broadcasting signal to all possible receivers. By contrast, where the receiver/user decides on the timing, the order and the scope of the consulted works or recording and she takes the initiative for the transmission of the requested data, the characteristic interactive element is met. In this case it was the user alone who decided on the timing and the duration of the requests, on the content of the programmes and the order of the songs. The provider merely makes and keeps the records accessible.

### 3. Conclusion on the making available right

The making available right is not defined in the Information Society Directive nor in the WIPO Treaties of 1996. It was attempted to understand this right more clearly by establishing its outer boundaries.

Firstly, the making available right should be understood as an implementation of the WIPO 1996 Treaties. It is placed in the context of the InfoSoc Directive, in which it is qualified as a species of the right of communication to the public and distinguished from the distribution right. By consequence, the exhaustion principle does not apply after a work is “sold” via an on demand platform (although it cannot be excluded that the CJEU extends its *UsedSoft* ruling to other works than computer programs).

In the cases examined, the courts have applied the making available right to various online services (e.g. web sites, hyperlinking, peer-to-peer networks, news services, online video recorders, cloud storage services).

The making available right requires (i) the availability of the work (ii) to the public (ii) on demand of members of the public.

The starting point of the making available right is the **availability** (preceding the transmission on demand of the member of the public). It should however immediately be verified whether the public has access to the work. The mere storage on a server where the work could theoretically be accessed by a “public” does not seem to suffice: the distribution of the access key (hyperlink) that allows the public access to the stored content may in some cases trigger the qualification as an act of “making available”. The work must be available for download or streaming. So far the endpoint of the making available right by contrast has not been addressed in the national decisions (transmission resulting from a demand of a

---

80 OLG Stuttgart 21 January 2008, Az. 2 WS 328/07; 2 Ws 328/2007, Telemedicus, available via <http://tlmd.in/u/488>.

member of the public or reception by the member of the public). By contrast the reception of the work has been addressed under the reproduction right (*infra*).

Members of the “**public**” should have access to the work on their demand. As long as no “public” has access, the availability on demand is not protected under the making available right. Regard should thus be had to the circle of people having access to the work. Insofar as the “public” is a notion common to all species of the genus right of communication to the public, it seems that decisions of the CJEU on this point apply to the making available right. The “public” is then an “indeterminate number of viewers” (or users), by contrast to a “private circle” and it should be to some extent targeted by the user and receptive to the communication, it is not merely caught by chance. The use of certain “cloud” services should not as such be qualified as examples of making available to the public, these can be used for personal purposes.

Few cases have considered the “**on demand**” aspect of the making available right, although this distinguishes the making available right from other forms of communication, in particular the broadcasting right.

## B. Territoriality and localisation

The second pillar of this research is the notion of “territoriality”. The starting point of this Study is that “*the protection of copyright and related rights in the EU is “territorial” in the sense that the recognition and enforcement of rights occurs on a country by country basis (nevertheless, the management of rights does not need to be territorial and right holders are often in a position to grant multi-territorial licences)*” (see Commission’s Request for services part I, p. 2). This “territoriality” is contrasted to the internal market and its proper functioning.

Generally, the notion of “territoriality” is understood as referring to the *nationally* defined territory, which is the territory that national legislators issue regulations for. The “territoriality” of a right does not *per se* imply that the territory should be a national one (cf. the Community trademark and design rights). The issues relating to the “territoriality” of the making available right can therefore be approached from two perspectives: either the “territoriality” of the right is altered from a national one to a “European” one<sup>81</sup>, or the principle of “national territoriality” of the right is kept intact but it is examined how some of its corollaries can be mitigated. Only the latter option will be examined in this Study.

The “territoriality” of the making available right should thus be reconciled with the inherently international (cross-border) nature of many on demand exploitations, especially via the Internet. This matter of territoriality cannot be severed from the elements of the definition of the making available right (*supra sub A*). If the territoriality principle by itself leads to an accumulation of restricted acts even where only one act of exploitation is performed, this outcome is even more likely if the Member States are free to adopt their own definition of the restricted act.

In the Commission’s request, several criteria are mentioned to link an act of making available “online” to a particular (national) territory: access to the work (in all Member States), origin of the service, establishment of the service provider. For the reproduction right (independently defined of the making available right), the pertinent territory is the country where the work is downloaded.

It is important to reflect on the notion of “territoriality” and get an overview of the issues that are related to this “territoriality” of copyright. When the “territorial” character of one aspect of the copyright system is tinkered with, it will have consequences for other related (though perhaps not immediately visible) aspects.

---

81 Commission, A Single Market for Intellectual Property Rights, Boosting creativity and innovation to provide economic growth, high quality jobs and first class products and services in Europe”, COM(2011) 287 final, p.11, at [http://ec.europa.eu/internal\\_market/copyright/docs/ipr\\_strategy/COM\\_2011\\_287\\_en.pdf](http://ec.europa.eu/internal_market/copyright/docs/ipr_strategy/COM_2011_287_en.pdf)

We will examine the origin of the “territoriality” principle in copyright and its application in the cases brought before the CJEU. Then we will verify how the “territoriality” is dealt with in the context of the international protection of the Berne Convention. Finally we will describe the territorial reach of some material acts protected under copyright and how the European legislator has adopted two principles to mitigate these consequences, i.e. the “country of origin” principle in the Satellite and Cable Directive and the “exhaustion” principle in the Information Society Directive.

### **1. Principle of state sovereignty: “National territoriality” of copyright**

The national territoriality of copyright is an application of the state sovereignty principle: the national state alone is by principle competent to issue regulations applicable to activities occurring on their national territories<sup>82</sup>. This means that a state cannot regulate activities taking place outside its national borders, on the territory of another state.

This principle can be explained by copyright’s origins. Before the adoption of proper copyright laws, a similar protection was granted under a system of privileges, which belonged to public law and were strictly territorial<sup>83</sup>. Furthermore, in the 19<sup>th</sup> century the majority of intellectual property disputes were wholly domestic and the cross-border litigations involving foreign elements were rare<sup>84</sup>.

Nowadays, the territoriality principle remains: in principle the national Member States are competent to legislate in the field of copyright<sup>85</sup>. The protection of the national copyright is restricted to the national territory and the exclusive right only covers activities occurring on the territory of that state<sup>86</sup>. Consequently the national legislators are entitled to shape the copyright system according to their (national) insights (protected subject matter, authorship and derived ownership, restricted acts and exceptions, duration, enforcement,...).

The EU legislator has not taken over this legislative competency, but national legislators are obliged to conform their national copyright legislation to the European directives issued in this field (harmonisation).

### **2. International protection: territoriality principle in the Berne Convention**

The principle of territoriality is one of the pillars of international protection of the Berne Convention. This convention deploys various mechanisms to cope with international issues of copyright protection<sup>87</sup>, in particular the harmonisation of substantive provisions (minimum protection) and the protection of authors under national copyright laws (applicability of the Berne Convention and the principle of national treatment).

The protection under the Berne Convention and the scope of protection depends on the link with the territory of a state, i.e. the nationality of the author or the place of publication of the work. Yet the national

---

82 P. GOLDSTEIN & P.B. HUGENHOLTZ, *International Copyright*, 95.

83 R. MATULIONYTÉ, *Law applicable to copyright : a comparison to the ALI and CLIP proposals*, Edward Edgard Publishing Limited, Cheltenham, 2011, 14-22.

84 N. BOSCHIERO, “Intellectual Property in the light of the European conflict of laws”, <http://www.ialsnet.org/>

85 P.B. HUGENHOLTZ, “The last frontier: Territoriality”, in M. VAN EECHOU, P. B. HUGENHOLTZ, S. VAN GOMPEL, L. GUIBAULT, & N. HELBERGER (Eds.), *Harmonizing European Copyright Law*, 2009, Alphen aan den Rijn: Kluwer Law International, p. 374.

86 A. PEUKERT, “Territoriality and Extraterritoriality in Intellectual Property Law”.

87 Rather than creating a “universal” copyright: J. C. GINSBURG, “Berne Without Borders: Geographic Indiscretion and Digital Communications”, Stephen Stewart Memorial Lecture, Intellectual Property Institute London U.K., Oct. 29, 2001, retrieved from [http://papers.ssrn.com/sol3/papers.cfm?abstract\\_id=292010](http://papers.ssrn.com/sol3/papers.cfm?abstract_id=292010).

states (Berne members) are in principle free to determine their own copyright regime and their own copyright (and socio-cultural) policy (save substantive harmonisation<sup>88</sup>).

The Convention defines which authors can benefit from this protection (art. 3 BC). The nationals of countries of the Berne Union (or those who have their habitual residence there) and non-nationals whose works were first (or simultaneously) published<sup>89</sup> in the Berne Union can invoke the protection of the convention.

The nationality of the author and, subsidiarily, the country of first publication determine whether the author can claim protection under the Berne Convention. Territoriality (in terms of country of first publication) thus only plays a role for non-Union authors<sup>90</sup>.

The authors to whom the Convention is applicable following art. 3 BC enjoy the same rights as the nationals of the state where protection is claimed (principle of national treatment – art. 5 BC). But the scope of protection further depends on whether protection is claimed outside or in the country of origin of the work (art. 5 BC). It has been argued that this is not a norm to determine the applicable law but a norm that determines whether a foreigner is entitled to claim rights (a foreign law could be applicable by virtue of the rules of conflict of laws of the country of origin<sup>91</sup>).

- Within the Berne Union but outside the country of origin, a foreign author can claim the same protection as the nationals of the country (Berne member) and the (substantive) protection of the Berne Convention (art. 5(1) BC). The extent of the protection and the means of redress are governed exclusively by the laws of the country where protection is claimed (for which protection is claimed) (art. 5(2) BC).
- In the country of origin, the protection is governed only by domestic law (without the minimum protection of the Convention), both to national and to foreign authors.

Since it determines the scope of protection (in terms of guaranteed rights), the definition of the country of origin is crucial. Now, the country of origin is determined by the publication of the work or (for unpublished works or works first published outside the Berne Union) the nationality of the author (art. 5(4))

---

88 GINSBURG mentions however that in two (facultative) exceptions the effects of these exceptions should be limited to the country where they are prescribed, i.e. the compulsory licence for broadcasts and secondary transmissions of broadcasts (art. 11bis BC) and the one for reproduction of musical works in sound recording (art. 13(1) BC). She raises the question whether these compulsory licences can be applicable to online exploitations. GINSBURG, "Berne Without Borders".

89 A "published work" is defined in art. 3(3) BC: "The expression "published works" means works published with the consent of their authors, whatever may be the means of manufacture of the copies, provided that the availability of such copies has been such as to satisfy the reasonable requirements of the public, having regard to the nature of the work. The performance of a dramatic, dramatico-musical, cinematographic or musical work, the public recitation of a literary work, the communication by wire or the broadcasting of literary or artistic works, the exhibition of a work of art and the construction of a work of architecture shall not constitute publication". According to RICKETSON and GINSBURG, making available for digital copies, e.g. by offering for download, should be understood as a "publication" in the sense of art. 3(3) BC: S. RICKETSON & J.C. GINSBURG, *International copyright and neighbouring rights*, Oxford, University Press, 2006, vol. I, 278, par.6.52. Other authors consider that the making available right does not fall under the scope of the Berne Convention. They remind that there was a proposal to adapt that definition of published works to cover the online use of works at the WIPO Conference in Geneva in 1996, but that attempt failed as countries could not reach a compromise (A. DE FRANQUEN, « L'arrêt Google contre Copiepresse et le choix de la loi applicable en matière d'atteinte au droit d'auteur sur Internet », R.D.T.I., 2011, 65). As a consequence, several authors consider that the making available of a work on internet is not a publication in the sense of article 3 of the Berne Convention (A. CRUQUENAIRE, "La loi applicable au droit d'auteur: état de la question et perspectives", 16, retrieved via <http://www.crid.be/pdf/public/4048.pdf>). A LUCAS considers that "(...) simply making a work available through digital networks, which will increasingly be the rule in future, does not amount to publication. To avoid this conclusion which is difficult for mere mortals to understand, consideration may of course be given to broadening the definition of publication as to encompass disclosure through a network. However, as this "clean-up" will also mean revising the Berne Convention, it will also be necessary to determine the location of such disclosure." (A. LUCAS, A. LUCAS "Applicable law in copyright infringement cases in the digital environment", e-Copyright Bulletin, 2005, retrieved via [http://portal.unesco.org/culture/en/files/29336/11338009191lucas\\_en.pdf/lucas\\_en.pdf](http://portal.unesco.org/culture/en/files/29336/11338009191lucas_en.pdf/lucas_en.pdf).10).

90 S. RICKETSON & J.C. GINSBURG, *International copyright and neighbouring rights*, par.6.55.

91 A. LUCAS, "Private International Law aspects of the protection of works and of the subject matter of related rights transmitted over digital networks", WIPO Forum On Private International Law And Intellectual Property, Geneva 30-32 January 2001, retrieved from [http://www.wipo.int/edocs/mdocs/mdocs/en/wipo\\_pil\\_01/wipo\\_pil\\_01\\_1\\_prov.pdf](http://www.wipo.int/edocs/mdocs/mdocs/en/wipo_pil_01/wipo_pil_01_1_prov.pdf).



BC)<sup>92</sup>. For published works, the country of origin is the country of first publication. In case of simultaneous publication in several countries of the Berne Union, the country of origin is the country of publication with the shortest term of protection. In case of simultaneous publication in a country of the Berne Union and a country outside the Berne Union, the country of origin is the country member of the Berne Union.

GINSBURG demonstrates how this criterion is problematic for works made available online<sup>93</sup>. Either the posting on a website is not considered a “publication” in the sense of the Berne Convention (since this would require “copies” available in sufficient quantities according to art. 3(3) BC). In that case, the work is an “unpublished” work and the country of origin is then the country of the Union of which the author is a national (art. 5(4)(c) BC). Alternatively, a posting online could be considered as a publication since the user can make (permanent or temporary) copies of the works. In that case, any country where the work is accessible via the Internet could be the country of first publication. Each could be the country of origin, so only domestic law would apply and the author could in any case be deprived of the Berne minimum protection. If the first publication has taken place simultaneously in several Berne countries, then the country with the shortest term of protection is the country of origin (art. 5(4) BC). This would mean that the term of protection in the country where protection is sought is lowered to the term of the country of origin (art. 7(8) BC), i.e. the shortest term available in the Berne Union. Moreover, all internet published works would be localised in the country with the shortest term of protection. In order to avoid this outcome, GINSBURG suggests choosing one country as the country of origin. However, she comes to the conclusion that none of the traditional criteria seem meaningful and neither the country from which the author communicated the work to the server nor the country where the website is localised through which the work is communicated to the public are necessarily significant<sup>94</sup>. A solution to this problem could consist in a further harmonisation at the international copyright level, or uniform choice of law rules.

A final note should be made in relation to new forms of exploitation. Whether these come within the “rights” for which national treatment should be reserved depends on the Convention, not on the national legislation. The question is whether, under the Berne Convention, national treatment should be given to foreign authors where the making available right is concerned<sup>95</sup>.

---

92 Art. 5(4): The country of origin shall be considered to be:

- (a) in the case of works first published in a country of the Union, that country; in the case of works published simultaneously in several countries of the Union which grant different terms of protection, the country whose legislation grants the shortest term of protection;
- (b) in the case of works published simultaneously in a country outside the Union and in a country of the Union, the latter country;
- (c) in the case of unpublished works or of works first published in a country outside the Union, without simultaneous publication in a country of the Union, the country of the Union of which the author is a national, provided that:
  - (i) when these are cinematographic works the maker of which has his headquarters or his habitual residence in a country of the Union, the country of origin shall be that country, and
  - (ii) when these are works of architecture erected in a country of the Union or other artistic works incorporated in a building or other structure located in a country of the Union, the country of origin shall be that country.

93 J.C. GINSBURG, “Berne Without Borders”. See also S. RICKETSON & J.C. GINSBURG, *International copyright and neighbouring rights*, vol. I, 286, par. 6.59.

94 J. GINSBURG, “Determination of country of origin when a work is first publicly disclosed over the Internet”, report by the country of origin study group of the International Literary and Artistic Association (ALAI), <http://www.alai.hu/index.php/dokumentumtar/alai-dokumentumok/70-szarmazasi-oroszag-webes-nyilvanossagra-hozatalnal/file..>

95 P. GOLDSTEIN & P.B. HUGENHOLTZ, *International Copyright*, 100. RICKETSON and GINSBURG take a broader view and state that that the application of the principle of national treatment is determined by the identification of the persons eligible to claim protection, protected subject matter, protected substantive rights, duration of the protection, exceptions and remedies. An author benefiting from the Convention’s protection should thus have the benefit of whatever the national provisions are these matters, insofar as they go beyond what is required by a specific Conventional rule. See S. RICKETSON & J.C. GINSBURG, *International copyright and neighbouring rights*, vol. I, 315, par. 6.95. . Regardless of the Berne Convention, there should be no discrimination between European nationals (art. 12 TFEU, art. 21 Charter of Fundamental rights of the EU – see also M. WALTER & L. RIEDE, “Principle of non-discrimination” in M. WALTER & S. VON LEWINSKI, *European copyright law*, 2010, Oxford University Press, 39 et s..

While the Berne Convention leans on the national territoriality principle to structure its protection (through the requirement of national treatment), its application and scope of protection are uncertain in case of online exploitations, since it is disputable whether such forms of exploitation are “publications” in the sense of the Berne Convention.

### 3. Territorial reach of material acts

If national states, including Member States of the European Union, are entitled to regulate conduct engaged in on their national territories and if the international system of copyright protection relies on the coordinated effort to protect certain behaviour (and to exclude other), then it should be verified how the material acts are translated in copyright terms at the national level. This may be delicate in case of cross-border processes in which different constitutive elements can be identified and each may be qualified as an act protected under copyright.

In other words, the overall protection of such cross-border process depends on the definition the Member States give to the protected acts and how they localise the relevant acts on their territory. In this section it will be discussed how the material acts can relate to the protected act in copyright (sub a), how the protected acts have been localised in the cases before the Court of Justice so far (sub b) and, finally, which mechanisms currently mitigate the territoriality of some exclusive rights (sub c).

#### a) Material act v protected act

The **reproduction right** protects the making of a material copy (art. 2 InfoSoc Dir). From the decisions of the CJEU, it appears that this should be taken in a technical sense: whenever a work is fixated on a tangible medium (however ephemerally), an act of reproduction is performed<sup>96</sup>. A Member State is competent to regulate the material copies made on its territory. Such reproductions may be subject to the author's prior consent or be covered under a national exception, which may be subject to mandatory compensations. The localisation of such reproduction is fairly straightforward, as long as it applies to simple, “traditional” forms of reproduction<sup>97</sup>.

In *Dramatico v Sky I* a UK High Court decided that a user of The Pirate Bay's torrent file sharing service who selects a file and downloads it copies the content of the file on her computer and infringes copyright if this file contained a copyright work<sup>98</sup>. Since they were customers of UK access providers they were in the UK. It was thus established that the defendant access provider's services were used for infringing copyright (in view of getting a blocking injunction against this ISP). In *EMI v Sky* the same UK High Court decided in the same sense that the UK users of file sharing services, who have accounts with some British access providers and are therefore in the UK, infringe copyright by copying sound recordings in the UK<sup>99</sup>.

The **distribution right** is related to the reproduction right in the sense that it protects the subsequent phase of distribution of the object in which the work is incorporated (art. 4 InfoSoc Dir). The author (or holder of a neighbouring right) has the right to control the distribution by sales or any other legal transaction that entails a transfer of ownership (Cassina).

---

96 CJEU 16 July 2009, Case C-5/08, Infopaq International A/S v Danske Dagblades Forening (Infopaq I); Premier League; CJEU 17 January 2012, Case C-302/10, Infopaq International A/S v Danske Dagblades Forening (Infopaq II). The reproduction right will be examined more in depth infra.

97 The Advocate General in Pinckney considered that by principle the reproduction has no cross-border aspect : Opinion of the Advocate general JÄÄSKINEN of 13 June 2013 in the case C-170/12, Peter Pinckney v KDG Mediatech AG, par. 53.

98 UK High Court of Justice 20 February 2012, [2012] EWHC 268, Dramatico Entertainment and others v British Sky Broadcasting and others (Dramatico v Sky I), par. 40.

99 UK High Court of Justice 28 February 2013 [2013] EWHC 379 (Ch), EMI and others v British Sky Broadcasting and others.

The distribution of an object may entail several successive operations, protected under this right. In case of cross-border transactions, restricted acts can be found in several Member States, under the national copyright law (Donner). The effects of the territoriality principle have been controlled by the (European) exhaustion principle (*infra*).

The **right of communication to the public** covers a wide range of exploitation forms. Some may only have a local effect, limited to the territory of a Member State (e.g. the public screening of a television broadcast, on demand availability via an intranet of a company or a university). Other forms are meant to be local but may have some (incidental spill-over) effect on the territory of a neighbouring state (e.g. traditional broadcasts)<sup>100</sup>. In that case, the question is whether this spill-over to another Member State should be qualified as an additional act of communication to the public in that Member State. The same questions arise in relation to communications via the Internet. Both linear and on demand communications via the Internet have the potential to reach a worldwide public. It is technically possible to restrict the addressees of such communications according to any criterion of the sender's choice. The sender may choose to impose territorial or other qualitative restrictions: she could make it impossible to access the work from certain countries or select the people who may consult the work (e.g. "friends" on social networking media, membership of a site).

Whether the communication with a multi-territorial reach (such as the making available to the public) ultimately has legal consequences in each of the countries of that reach depends on the (national) definition of the restricted act. Especially in complex acts, several relevant elements may be localised in different Member States. It depends on the definition of the protected act which of those elements are relevant from a *legal point of view*. If it is considered that the making available right covers the "*whole act of communication, including the upload and the entire transmission to the download*"<sup>101</sup>, then every stage could be controlled on the national territory where it takes place. If it is considered that it is sufficient that a work is accessible to the public, then the territorial reach of the right of making available will be fairly large and it will take place in all the Member States unless access has been blocked in some Member States. When the right of making available does not protect the mere reception of a work (i.e. in private circles) nor the fortuitous capacity to access a work in any Member State, but requires that a certain public in a particular Member State is targeted by the person who performs the communication, then the territorial reach of the restricted act is smaller.

In *Dramatico v Sky I* the UK High Court concluded that it was not clear from the CJEU's decisions (before *Sportradar*) whether a communication to the public took place where it originated or where it is received<sup>102</sup>. The Court did not solve this issue, it was satisfied that the users of The Pirate Bay allow copies of sound recordings on their computers to be uploaded to the "swarm". Since UK users were involved as uploaders and downloaders, it was not necessary to decide whether the act of communication to the public was committed at the place of origination or the place of reception.

In *EMI v BSKyB* a UK High Court issued a decision on similar facts but after the CJEU's decision in *Sportradar (infra)*. The Court considered the decisions of the CJEU on the right of communication to the public and the database reutilisation right and concluded that an act of communication to the public occurs "*both where the communication originates and where it is received. Where a communication to the public which originates outside the UK is received inside the UK, the act will be treated as occurring within the UK if the communication is targeted at the public in the UK*"<sup>103</sup>. In this case, the communication to the public took place via bit torrent sites. The Court decided that the act of communication to the public occurs in the UK because the uploader was located in the UK. In the judge's view, it was more doubtful that the act could be localised there on account of the downloaders' location, since it was not clear to him

---

100 See about the extraterritorial application of national laws: A. PEUKERT, "Territoriality and Extraterritoriality in Intellectual Property Law" 12, 16.

101 A. PEUKERT, "Territoriality and Extraterritoriality in Intellectual Property Law" 17.

102 UK High Court of Justice, *Dramatico v Sky I*, par 68.

103 UK High Court of Justice 28 February 2013 [2013] EWHC 379 (Ch), *EMI v BSKyB*, nr. 38.

“that the act of communication by the uploaders [was] targeted at member of the public in the UK”<sup>104</sup>. The court did not consider it necessary to reach on conclusion on that point.

The High Court also treated the question whether the operators of the file sharing site, who were located outside the UK, infringed the right of communication to the public. It found, firstly, that there was an act of communication by electronic transmission, secondly, that a new public was reached and, thirdly, that the act of communication to the public occurred in the UK. Citing the CJEU's decisions in *Sportradar*, *Pammer*, *L'Oréal* and *Donner* (*infra sub* Part I, B, 3, b), the Court followed the claimant's position that the bit torrent websites were targeted at the public in the UK: a large number of users of the websites were in the UK, a substantial proportion of the visitors to the websites was from the UK, the recordings listed on each Websites included recordings by UK artists and recordings in demand in the UK, the default language of the sites was English and in one case a website had advertisements with prices in sterling<sup>105</sup>.

The exclusive economic rights considered separately raise questions about the territorial reach of the material acts. But it becomes all the more pressing when several acts, which could separately be qualified as reproductions or communications to the public, are combined in complex technical processes.

The dissection of the process could lead to an accumulation of protected acts (and applicable exceptions) on different territories, so various Member States may be competent to regulate (integrated) parts of the same process. For example, the storage of a work on a server from which a work is made accessible online could be qualified as a reproduction and as an act of making available to the public (provided that a “public” is granted access). The intermediate copies during the transmission, reception or later consultation of the works could be reproductions, which may be exempted under the exception for temporary acts of reproduction (art. 5(1) InfoSoc Directive). Finally, the transmission and the reception of works following an online request could be protected under the making available right as well.

Moreover, different “layers” of exploitation may be found where works are shared online. For example, a work may be uploaded to a website and subsequently be brought within the sphere of a social networking site by a user who wishes to share the work with her contacts. This may be achieved either by making an additional copy (stored on the servers of the social networking site) or by means of a hyperlink<sup>106</sup> – the result is that the work is visible to the users of the social networking site. The question is whether in this case a distinct act of making available can be found, since a new public is reached (the contacts of the user of the social networking site)<sup>107</sup>. On the other hand it could be argued that this finding depends on the underlying reproduction of the work.

A similar uncertainty exists where a work is made available in the context of an online service (e.g. an online streaming service offered to paying members) and where the service provider offers the users the possibility of making play lists and sharing these with the members of their networks (“friends”). Should such intervention be considered an act of making available, considering on the one hand that a “new public” may be reached but, on the other hand, that no new copy is made and that the “new public” are already paying members of the same service?

Since the issue of overlap of exclusive economic rights has not been sorted at the European level, the territoriality principle may be another cause for concern.

## **b) Territoriality and localisation in the CJEU decisions**

The CJEU has had several occasions to examine cross-border situations and rule on where the restricted act under consideration takes place. In several decisions, it has explicitly confirmed the “principle of

---

104 UK High Court *EMI v BSkyB*, par. 41.

105 UK High Court *EMI v BSkyB*, par. 51.

106 See reference for a preliminary ruling in *Svensson* (pending).

107 See *inter alia* *Rafael Hoteles*; *Premier League*, , *Airfield*. See however also *TVCatchup*.

territoriality” of copyright. It has considered different circumstances (terrestrial broadcast, distribution of blank media and furniture, distant access to a database) in the light of different directives (Rental and Lending Directive, Information Society Directive, Database Directive). In each case, it has considered the relevant material acts per the exclusive right and how it should be connected to the territory of the Member State involved.

*(i) Lagardère*

Territoriality was an issue discussed in the ruling of the CJEU in *Lagardère* case.

In this case, a French broadcaster had set up a complex broadcasting system, in order to transmit television programmes to the French public. The signals were transmitted by Europe 1 to a satellite, which transmitted the broadcast to a (French) ground station, from which a terrestrial (Hertzian) signal was sent that could be captured by the (French) public. The broadcast from the French ground station covered most of the French territory. However it was more difficult to receive it in the border area with Germany, so the satellite signals were also sent to a ground station on German territory, from where it was then broadcast (by Hertzian waves) to the French territory (though it could also be received on the German side of the border area).

Both the German and the French collecting societies claimed payment of the “single equitable remuneration” for performers and producers<sup>108</sup>. The issue was whether the broadcaster had to pay this remuneration both in France and in Germany and, if this was the case, whether the amounts could be compensated (in order to avoid double payment).

The obligation to pay the equitable remuneration depended firstly on the qualification of the technical construction, combining the satellite signal and the subsequent terrestrial broadcast of programs, as a “satellite broadcast” in the sense of the SatCab Directive and, secondly, on the competence of the Member States to determine the equitable single remuneration in the sense of the Rental and Lending Directive.

It was first established that the satellite communication in *Lagardère*’s construction should not be qualified as a satellite broadcast in the sense of the SatCab Directive. By consequence the rule that locates the satellite broadcast in one Member State only (country of origin) was not applicable (art. 1(2)(b) SatCab Dir).

The defence that the single equitable remuneration was only due in France as the country of origin of the satellite broadcast therefore failed. It was concluded that it should be determined whether a fee was due in the Member State, where the **broadcaster was established** and in the Member State where, for technical reasons, the **terrestrial transmitter** (that was broadcasting to the first state) was located. At this point, the Court explicitly recognised the principle of territoriality (emphasis added): “*At the outset, it must be emphasised that it is clear from its wording and scheme that Directive 92/100 provides for minimal harmonisation regarding rights related to copyright. Thus, it does not purport to detract, in particular, from the principle of the territoriality of those rights, which is recognised in international law and also in the EC Treaty. Those rights are therefore of a territorial nature and, moreover, domestic law can only penalise conduct engaged in within national territory*” (*Lagardère*, par. 46 – our emphasis).

The Court identified the “conduct engaged in” as the broadcast of phonograms using terrestrial transmitters, situated in the French resp. German territories. The material act of broadcasting was carried out in the territory of two Member States hence both the French and German copyright laws could apply to decide whether an equitable remuneration was due (par. 47).

---

<sup>108</sup> For a broadcast of a commercial phonogram – see art. 8 dir. 92/100 now dir. 2006/115.

The territoriality of the conduct – or its effect – comes into play in yet another respect, i.e. the criteria to calculate the amount of the equitable remuneration. The Member States enjoy a certain freedom to set these criteria, as long as the European criteria are respected (i.e. a proper balance between interests of right holders and third parties, on reasonable terms and the assessment in the light of the value of that use in trade, see Lagardère, par. 50, with a reference to the SENA, par. 37<sup>109</sup>).

According to the Court, the value of the broadcast should be assessed taking into account “*all the parameters of the broadcast, such as, in particular, the actual audience, the potential audience and the language version of the broadcast*” (Lagardère, par. 51). The value of the broadcast in the national territory is thus determined by the (commercial) exploitation in that same national territory. In this case the value of the use in trade is monetised where the broadcasting company is established, i.e. France (Lagardère, par. 52), and the actual commercial exploitation only takes place within French territory (advertisement slots are offered to French advertisers, almost the entire audience is situated in France since the broadcast can be captured mainly in France and the broadcast programmes are in French). In addition, a remuneration may be due in Germany, calculated according to German law: the terrestrial transmitter is situated on the German territory so, by virtue of the territoriality principle, the German copyright act applies, and accordingly an equitable remuneration may be calculated in function of the value present in Germany. Since it is not excluded that an actual or potential audience for the broadcast exists in Germany (however small), by principle a fee may be imposed. Its rate should however be low, considering the low economic value of the broadcast in Germany (Lagardère, par. 54).

The payment of the equitable remuneration is thus based on the use of a phonogram in one Member State and it cannot be taken into account to calculate the equitable remuneration due for use in another Member State. The conclusion is that the broadcaster is not entitled to compensate the amounts of the remunerations and to deduct the equitable remuneration paid in the country where the transmitter is located (Germany) from the remuneration due in the country where the broadcaster is established (France).

The CJEU's decision in “Lagardère” not only formally recognises the territoriality principle in copyright, but it also clarifies which factors determine the application of copyright.

The territoriality comes into play at two moments. Firstly, the obligation of paying an equitable remuneration in a certain Member State is triggered by the material act of broadcasting and, secondly, the amount of the equitable remuneration depends on the exploitation within the territory of a Member State. A (material or causal) relation between the material act of broadcast and the value of the use (or exploitation) of the protected matter is not required: the equitable remuneration due in France for the broadcast of the phonograms should be determined in function of the value (exploitation) in France. The fact that a part of this exploitation is realised by a material transmission from Germany is not relevant: the entire value of the commercial exploitation is realised in France (French audience, French language) and this value should be taken into account for the rate of the equitable remuneration due in France. The material act of broadcast situated in Germany may give rise to an equitable remuneration in Germany as well: the broadcast is also transmitted in Germany and can be captured within Germany, by the German public. Since the audience in Germany will be very small, the rate of the equitable remuneration must be low.

In other words, the “territoriality” principle is thus applied in a literal way. Firstly, the **material act of broadcast** triggers the obligation to pay an equitable remuneration in the Member State where the material act takes place, not the exploitation of the work or the value of the use. Secondly, the rate of the equitable remuneration is determined by the **value (exploitation)** on the territory of that Member State, not by the value of the material act of broadcasting across the national borders, in function of the actual or potential audience materially reached by the material act of broadcasting. Since the directive under

---

109 CJEU 6 February 2003, case C-245/00, Stichting ter Exploitatie van Naburige Rechten (SENA) v Nederlandse Omroep Stichting (NOS).

consideration aimed at minimum harmonisation, it does not follow that this rather strict interpretation of “territoriality” applies to other directives, in particular the Information Society Directive.

**(ii) “Stichting De Thuiskopie”**

In the case “Stichting De Thuiskopie”, the CJEU examined the relation between the territoriality of a national levy system (for private copies) and its extraterritorial reach to ensure the effectiveness of such compensation systems<sup>110</sup>. At stake was the “fair compensation” due in counterpart of the private copying exception (art. 5(2)(b) InfoSoc Directive). The Dutch Copyright Act provides that the fair compensation should be paid by the manufacturer or the importer of the copying equipment (including blank media). The Dutch collecting society “Stichting De Thuiskopie” claimed payment of this compensation from a German company, which targeted the Dutch public and sold blank media via the Internet to Dutch customers. The German seller, Opus, argued that the transaction took place in Germany and that the Dutch customers, not Opus, were the importer of the blank media and therefore the debtors of the fair compensation.

The CJEU was seized to decide to which extent the Dutch law could apply to a German company, involved in distance selling to Dutch customers.

The CJEU gave priority to the obligation of Member States to ensure that the fair compensation is actually recovered and decided that the national law should be interpreted accordingly.

The starting point was that Member States are entitled to provide an exception for private use, the harm resulting from the application of this exception being repaired by a fair compensation. The Member States that had incurred an obligation to achieve the “*effective recovery of the fair compensation intended to compensate the authors harmed by the prejudice sustained, in particular if that harm arose on the territory of that Member State*” (Stichting De Thuiskopie, par. 34). The harm to the author was caused by the final user who reproduced the work and her residence determined where the harm occurred: “*it can be assumed that the harm for which reparation is to be made arose on the territory of the Member State in which those final users reside*” (Stichting De Thuiskopie, par. 35). The Member State had the obligation to ensure, in accordance with its territorial competence, the effective recovery of the fair compensation for the harm suffered by the authors on the territory of that state, i.e. where the final users resided who reproduced the work in conformity with the private copying exception (Stichting De Thuiskopie, par. 36).

Now, if the purchasers of the blank media as *final users* of the works resided in the Netherlands, the harm was suffered in the Netherlands. By consequence, according to Dutch law, the levy to compensate this harm was payable by the manufacturer or importer of the blank media. This meant that *in casu* the final user was the debtor of the levy (not the German seller residing and conducting its business in Germany). This outcome meant *de facto* that it was impossible to recover the fair compensation and to compensate the authors for the harm suffered. To avoid this result, the CJEU allowed an interpretation that guaranteed the recovery of that compensation from the seller who contributed to the importation. Moreover, it did not matter that the seller was established in another Member State than the final users/importers who resided in the Member State where the harm was suffered and where the fair compensation was due (Stichting De Thuiskopie, par. 40).

The conclusion was that “*that Directive 2001/29, in particular Article 5(2)(b) and (5) thereof, must be interpreted as meaning that it is for the Member State which has introduced a system of private copying levies chargeable to the **manufacturer or importer** of media for reproduction of protected works, and on the **territory** of which the harm caused to authors by the use for private purposes of their work by **purchasers** who reside there **occurs**, to ensure that those authors **actually receive the fair***

---

110 CJEU 16 June 2011, Case C-462/09, Stichting de Thuiskopie t. Opus Supplies Deutschland, Mijndert van der Lee and Hananja van der Lee.

**compensation intended to compensate them for that harm. In that regard, the mere fact that the commercial seller of reproduction equipment, devices and media is established in a Member State other than that in which the purchasers reside has no bearing on that obligation to achieve a certain result. It is for the national court, where it is impossible to ensure recovery of the fair compensation from the purchasers, to interpret national law in order to allow recovery of that compensation from the person responsible for payment who is acting on a commercial basis**" (emphasis added).

Without explicitly referring to this principle, this decision is centred on the application of the territoriality principle in copyright. The territoriality principle was first applied in a straightforward way. It was found that, within its competence, the Netherlands have provided an exception for private copying and a levy system for compensating the harm caused by this exception. Then it was established that the reproductions were made by users residing on the Dutch territory and that the harm to the authors was caused on the Dutch territory. The Dutch government had the obligation to achieve the result that the authors actually receive fair compensation for the harm suffered on the Dutch territory.

This obligation of the national State to ensure the reparation of the harm occurring on its territory and the effective recovery of the fair compensation could even justify an interpretation of a national norm that loosens the strict territorial application of a national norm. A national (Dutch) norm could be applied to a commercial German seller of blank media, established in Germany and organising its business in Germany and (seemingly) not engaging in any conduct in the Netherlands, if this interpretation would safeguard that Member State's obligation.

### **(iii) Donner**

In *Donner*, the issue was the localisation of the act of distribution to the public by sale. Titus Donner, a German citizen, faced criminal prosecution in Germany for his role in the organisation of cross-border sales of replica furniture. An Italian company sold these reproductions and targeted its marketing at the German public and delivered to customers in Germany (with a system for paying or taking back the goods). This furniture was protected under German copyright law but not (effectively) under Italian law.

The issue was whether the German person (heading the freight forwarding firm) could be criminally pursued in Germany for infringement of the distribution right.

The Advocate General, citing the Court's decision in *Lagardère*, confirmed the principle of territoriality in copyright law, in the sense that "*domestic law can only penalise conduct engaged in within national territory*", while at the same time admitting certain extra-territorial effects, since the "*exercise [of copyright] may also catch activities partly or completely situated outside of national borders*" (Opinion Advocate General in *Donner*, par. 33). The Advocate General referred to the CJEU's decisions in *L'Oréal*<sup>111</sup> and *Stichting De Thuiskopie*, to establish that "*behaviour that takes place outside the territory where rights were protected, but which was aimed at that territory, fell within the reach of provisions of intellectual property law that have been harmonised by EU law*" (Advocate General in *Donner*, par. 34-37).

---

111 CJEU 12 July 2011, Case C-324/09, *L'Oréal SA and Others v eBay International AG and Others*, opinion Advocate General JÄÄSKINEN of 9 December 2010 (L'Oréal). In this case, the question was whether an offer for sale originating outside the EEA could amount to a trademark infringement on the account that it was accessible via an online market place. The Court decided that it should be verified (by the national court on a case-by-case basis) whether such display was targeted to the consumers on the territory of the Member State where the trademark is protected. Details of the geographic areas to which the seller is willing to dispatch the product or similar details are particularly important for this assessment. Inversely, the Court stated that "the mere fact that a website is accessible from the territory covered by the trade mark is not a sufficient basis for concluding that the offers for sale displayed there are targeted at consumers in that territory (see, by analogy, Joined Cases C-585/08 and C-144/09 *Pammer and Hotel Alpenhof* [2010] ECR I-0000, paragraph 69). Indeed, if the fact that an online marketplace is accessible from that territory were sufficient for the advertisements displayed there to be within the scope of Directive 89/104 and Regulation No 40/94, websites and advertisements which, although obviously targeted solely at consumers in third States, are nevertheless technically accessible from EU territory would wrongly be subject to EU law" (par. 64). These cases will be discussed infra.



The Advocate-General first described the notion of “distribution to the public” in the sense of art. 4(1) InfoSoc Dir as “*covering the chain of activities from offers of sale through to the conclusion of sales contracts and their implementation*” (Opinion Advocate General in *Donner*, par. 354). Then he went on to apply the criteria of *L’Oréal* (consumer targeting, specific delivery arrangement and payment method) to summarise the main factors, i.e. whether the seller has created a targeted sales and delivery channel for buyers to acquire works that are copyright protected in the buyer’s Member State. The Advocate General found such targeted exercise directed at the German public, given the German language website, the marketing material, the cooperation with the freight forwarding company engaged in sales and delivery to Germany.

The Court of Justice followed the same approach and answered the question by a description of the right of distribution to the public and by localising this (complex) act.

The notion of distribution to the public (art. 4(1) InfoSoc Dir) was understood as “*making available to the public through sale*” (art. 6(1) WCT) and it was characterised by a series of acts, going from the conclusion of the sale contract to the delivery to a member of the public. In case of a cross-border sale, consisting of several acts which may take place in different Member States, the distribution right may be infringed in a number of Member States (*Donner*, par. 26).

The Court found that, in complex operations involving different actors, a trader is responsible for acts carried out “*by him or on his behalf*”, but also for acts by a third party “*where [the trader] specifically targeted the public of the State of destination and must have been aware of the actions of that third party*” (*Donner*, par. 27). Relevant factors were the existence of a website in German, the content and the distribution channels of advertising materials, a cooperation with a freight forwarding company making deliveries in Germany and these could be taken as proving such targeted activity. It was stated, generally, that “*a trader who directs his advertising at member of the public residing in a given Member State and creates or makes available to them a specific delivery system and payment method, or allows a third party to do so, thereby enabling those members of the public to receive delivery of copies of works protected by copyright in that same Member States, makes, in the Member State where the delivery takes place, a distribution to the public*”<sup>112</sup>.

In summary, the Court found that relevant acts, covered by the distribution right, had taken place in the Member State of destination, where the public had been targeted. It was not excluded that relevant acts of distribution could be found in other Member State as well.

#### **(iv) Sportradar**

In *Sportradar*, the question was asked how the act sending data, at the request of a user, should be qualified and where this act took place, knowing that the data were stored in a database, covered by the *sui generis* protection of Directive 96/9<sup>113</sup>,

The claimants, *inter alia* Football Dataco, organise football competitions in England and Scotland and Football Dataco manages the exploitation of the data relating to those matches, via the “Football Live” database, supposedly protected under UK law. Sportradar is a German company that offers (live) data on English football matches. Sportradar’s customers are *inter alia* betting companies, offering their services aimed at the UK market, from which it was inferred that the UK public was an important target for Sportradar (*Sportradar*, par. 10). End-users in the UK were guided, through the betting companies’ sites, to Sportradar’s betradar service.

---

<sup>112</sup> Donner, par. 30.

<sup>113</sup> Directive 96/9/EC of the European Parliament and of the Council of 11 March 1996 on the legal protection of databases, O.J. L 077, 27 March 1996, p. 20–28.

Football Dataco claimed that Sportradar's data services constituted an infringement of its database rights in the Football Live database and brought a legal action before the UK courts. The High Court rendered a decision on the joint liability of Sportradar and the end-users in the UK, but declined jurisdiction on the primary liability of Sportradar. The Court of Appeal referred a preliminary question to the Court of Justice, in order to establish its jurisdiction in respect of the primary liability of Sportradar<sup>114</sup>. The answer to these questions should allow the Court of appeal to establish whether the UK courts had jurisdiction with regard to the liability of both defendants (noting that the CJEU was not asked to rule directly on the issue of jurisdiction).

The first question concerned the qualification of the operation. The service operator (Sportradar) uploaded data, from a protected database (Football Live), to a server in Member State A, and sent the data, at the request of the user, to the user residing in another Member State B where the data would be stored in the computer memory and displayed on the user's screen. The CJEU was asked to qualify the operation of *sending* data to a user, at that user's request, i.e. as an act of re-utilisation or extraction in the sense of the Database Directive. Secondly it was asked where this act took place: in Member State A, in Member State B or in both Member States A and B.

The Database Directive defines "reutilisation" as "*any form of making available to the public all or a substantial part of the contents of a database by the distribution of copies, by renting, by on-line or other forms of transmission*" (art. 7(2)(b) Database Dir). The directive does not contain a criterion to localise this act on the territory of one or more Member States.

The Advocate General held the opinion that the act of sending to a user's computer, upon his request, information obtained from a protected database, should clearly be considered an "*act forming a necessary constituent part of a process of making available to the public, which [...] constitutes a re-utilisation*" (Advocate General in Sportradar, par. 41). He explicitly limited his opinion to this act of sending, as requested by the referring court, which had severed the sending from other acts such as the upload of data by Sportradar (Advocate General in Sportradar, par. 34). Reutilisation should be considered as "*a generally complex act made up of acts needed to produce the effect of making available, which, in the language of the Directive itself, comprises reutilisation*" (Advocate-General in Sportradar, par. 42). The act of "sending" was considered one of the necessary component parts of that complex act and consequently shares the classification of the complex act, i.e. a reutilisation of data from a protected database (Advocate-General in Sportradar, par. 42, 47).

Answering the second question, the Advocate-General localised the reutilisation in both Member States A and B. He discarded the criteria of emission and reception and referred to the "intended target" criterion of the CJEU in *L'Oréal* and *Pammer and Hotel Alpenhof*. He then considered that the reutilisation would include a "*sequential succession of a number of acts, which having as their purpose the 'making available' of certain data via a networked and multi-polar communication medium*" (Advocate-General in Sportradar, par. 59). By consequence, the place of that reutilisation should be the place of each of the acts needed to produce the result comprising the re-utilisation, i.e. the both in Member States A and B.

The Court followed the Advocate General in his classification of the sending as an act of reutilisation. The Court first defined the restricted act as "*extending to any act, not authorised by the maker of the database protected by the sui generis right, of distribution to the public of the whole or part of the contents of the database*" and covering an act "*in which a person sends, by means of his web server, to another person's computer, at that person's request, data previously extracted from the content of a database protected by the sui generis right. By such a sending, that data is made available to a member of the public*" (Sportradar, par. 20-21).

The Court then went on to determine the Member State where the act of reutilisation took place. It confirmed the **territoriality** principle with regard to sui generis database rights: "*the protection by the sui generis right provided for in the legislation of a Member State is limited in principle to the territory of that*

---

114 Court of Appeal 6 February 2013, case Nos A3/2012/1349, 1352, 1354 and 1366 [2013] EWCA Civ 27.

Member State so that the person enjoying that protection can rely on it only against unauthorised acts of reutilisation which take place in that territory” (Sportradar, par. 27). In order to decide whether the database right has been infringed under UK law, it should be assessed whether the “acts of sending fall, as acts taking place within the [UK], within the territorial scope of the protection by the sui generis right afforded by [UK law]” (Sportradar, par. 28). The Court took into account that this would affect the establishment of jurisdiction (art. 5(3) Regulation 44/2001) and applicable law (Regulation 864/2007).

The Court stated that the localisation of an act of reutilisation should correspond to independent criteria of EU law, like the definition itself. It considered that a reutilisation may indeed consist of successive operations, from the placing online so the public can consult the data via the website, to the transmission of the data to a member of the public and that these acts may take place in **several** Member States (Sportradar, par. 34). Considering the ubiquitous nature of the Internet, however, the Court stated that “the mere fact that the website containing the data in question is accessible in a particular national territory is not a sufficient basis for concluding that the operator of the website is performing an act of reutilisation caught by the national law applicable in that territory concerning protection by the sui generis right” (Sportradar, par. 36). Instead, the localisation of an act of reutilisation depends on the **intention** on the part of the person performing the act to **target** persons in that territory (Sportradar, par. 39). In this case, this intention should be demonstrated by the nature of the data (English football matches), the contracts with betting service operating in the UK, the remuneration scheme (access by UK users) and the language (different from the language of the Member State where Sportradar pursues its activities). Depending on the evidence, the referring court was entitled to localise the act of reutilisation in the Member State where the user was present to whose computer the data were transmitted, at her request, for purpose of storage and display on screen, i.e. Member State B (Sportradar, par. 43)

The court concluded that this act of sending is localised – at least – in the Member State “where there is evidence from which it may be concluded that the act discloses an intention on the part of the person performing the act to target members of the public in [that Member State]”<sup>115</sup>.

Both the Advocate-General and the Court accepted to qualify the isolated act of sending data to a user, at her request, as an act of reutilisation of a protected database. The preceding stage (storage, upload) was not taken into consideration.

As far as the localisation of the restricted act is concerned, the Advocate-General and the Court applied the same criteria but to different results. The act of reutilisation should be situated where the intended target public was located. Mere accessibility was not sufficient. This led the Advocate General to conclude that the act of reutilisation took place both in the Member States of sending and destination, whereas the Court decided that the act of reutilisation in this case was localised in the Member State of destination, provided that there was evidence of an intention to target the public residing in that Member State.

Two notes should be made with regard to this criterion. Firstly, both the Advocate General and the Court accept that this definition and this localisation criterion may lead to restricted acts in several Member States – “at least” in the targeted Member State. Secondly, this localisation criterion allows the referring court to take the *intention* of the service provider into account and the effects of its decisions.

### c) Mitigation of the consequences of national territoriality

An act of exploitation may cover the territory of several countries and this may result in an accumulation of restricted acts (territorial reach of material acts), with legal consequences on all sides of the border. The “territoriality” principle indeed entails that each Member State is entitled to regulate in the field of copyright as it pleases. Within the limits imposed by European directives and international treaties, each state can define the protected subject-matter, define and interpret the restricted acts and the exceptions,

---

115 Sportradar, par. 47.

the duration, set the rules for authorship and transfer of rights, ... When the constitutive elements of cross-border transactions are thus considered relevant acts under national copyright law, the author may exercise her right in every single Member State and each Member State may set their own terms for this exercise of rights.

The effects of the territorial nature of copyright have been mitigated by international and European harmonisation and by the principle of national treatment<sup>116</sup>. This means that the level of the author's protection is stabilised across national borders (within a certain margin). Moreover, copyright protection exists without formalities, by the mere fact of the creation of the work – regardless of where the work was created.

At the international level, the most prominent instruments of harmonisation are the Berne Convention and the 1996 WIPO Treaties (WCT and WPPT). At the European level, 7 directives harmonise various aspects of in the field of copyright and its neighbouring rights. In the European framework, two particular principles have been adopted to limit the effects of the territoriality principle: the “country of origin” principle in relation to communications to the public by satellite and the “exhaustion” principle in relation to the distribution right.

### ***(i) The “country of origin” principle in the Satellite and Cable Directive***

Due to its technical characteristics, a satellite broadcast covers the territories of several states (its “footprint”). It was controversial whether the right holders' consent was required in the state of broadcast or in each of the states of reception (the so-called “Bogsch” theory).

At the European level, this discussion was put to an end in the Satellite and Cable Directive<sup>117</sup>. This Directive, adopted a solution consisting of two elements: a definition of the notion of communication to the public by satellite and the determination of the location where such protected act took place. The definition of the protected act is “*necessary to avoid the cumulative application of several national laws to one single act of broadcasting*” (rec. 14 Satellite and Cable Directive).

The 'communication to the public by satellite' is defined as “*the act of introducing, under the control and responsibility of the broadcasting organization, the programme-carrying signals intended for reception by the public into an uninterrupted chain of communication leading to the satellite and down towards the earth*” (art. 1(2)(a) Satellite and Cable Directive).

It is furthermore determined in which Member State the communication takes place, i.e. it occurs “*solely in the Member State where, under the control and responsibility of the broadcasting organization, the programme-carrying signals are introduced into an uninterrupted chain of communication leading to the satellite and down towards the earth*” (art. 1(2)(b) Satellite and Cable Directive). If the act of communication to the public by satellite takes place outside the EU, alternative criteria are provided to attach it to a Member State (i.e. the uplink station in a Member State or the establishment of the broadcasting organization in a EU member State – art. 1(2)(d) Satellite and Cable Directive). The territorial reach of the satellite broadcast is thus focused to the Member State where broadcast has its origin: this is where the right holders' consent should be acquired and where the remuneration should be paid (FAPL, par. 111). This remuneration should however be calculated taking into account the actual and potential audience, both in the Member State of broadcast and in any Member State of reception (FAPL, par. 112). The footprint of the broadcast is taken into account for the calculation of the remuneration, but the broadcaster is not required to secure the right holders' authorisation in each Member State of the footprint.

---

116 A. PEUKERT, 'Territoriality and Extraterritoriality in Intellectual Property Law' 9-10.

117 The SatCab Directive resulted from the same green paper as the Television without frontiers and both aimed at establishing a common audiovisual market. Council Directive 89/552/EEC of 3 October 1989 on the coordination of certain provisions laid down by Law, Regulation or Administrative Action in Member States concerning the pursuit of television broadcasting activities, OJ L 298, 17 October 1989, p. 23–30.

The aim of the directive is however undermined by the practice of right holders to impose territorial restrictions by contract. The Commission found that the producers sell their programmes to broadcasting organisations on condition that the satellite broadcasts are encrypted in order to restrict the reception of the programmes to the national borders<sup>118</sup>.

Such contractual practices of fragmenting the internal market have been found contrary to the freedom to provide services and were considered an anticompetitive agreement in *Premier League*<sup>119</sup>. In this case, the FAPL had licensed its exclusive right of satellite broadcast on football matches to several (national) broadcasters in such a way that the overall result was an absolute exclusivity on the national territory in the Member State of broadcast. The CJEU decided that the territorial restrictions in the contracts resulted in an impediment of the freedom to provide services and in an anti-competitive agreement. The defence that these restrictions were justified by the objective of protecting the intellectual property rights involved was rejected because such a justification can only be invoked when the restriction is necessary to preserve the specific subject-matter of the intellectual property right concerned (FAPL, par. 145 in conjunction with par. 104-105). This includes the commercial exploitation or to make the protected subject matter available in return for an appropriate remuneration, though not the highest possible remuneration (FAPL, par. 107).

An “appropriate” remuneration should be reasonable in relation to the economic value of the service, which refers for satellite broadcasts to “*parameters of the broadcasts concerned, such as their actual audience, their potential audience and the language version*” (par. 110). It was found in this case that right holders were “*remunerated for the broadcasting of the protected subject-matter from the Member State of broadcast in which the act of broadcasting is deemed to take place, in accordance with Article 1(2)(b) of the Satellite Broadcasting Directive, and in which the appropriate remuneration is therefore payable*” (FAPL, par. 111). The remuneration can be determined taking into account “*the actual audience and the potential audience both in the Member State of broadcast and in any other Member State in which the broadcasts including the protected subject-matter are also received*” (FAPL, par. 112; 120). In this case, all recipients had to acquire a decoder card and thus pay a fee (opinion Advocate General, par. 198). The restriction to distribute decoders across the borders that materialises an absolute territorial exclusivity in return for a premium went beyond what was necessary to protect the specific subject matter of the possible IPR.

The case was distinguished from *Coditel I* in which no objection was found against partitioning a mark on a territorial (national) basis, to protect the exploitation of a work (opinion Advocate-General, par. 193-201; FAPL, par. 118-120). In *Coditel I*, a renewed consent was required for the retransmission by cable on the Belgian territory of an (authorised) German programme showing a film, which was screened in the Belgian cinemas at the same time. In *Premier League* by contrast, the partitioning of the internal market was not meant to protect t another form of exploitation and the satellite broadcast had been authorised and remunerated in Greece.

The SatCab Directive thus explicitly determines the material and territorial constraints of the satellite broadcasting right, by providing a definition of the right of communication to the public and a localisation

---

118 Report from the European Commission on the application of Council Directive 92/83/EEC on the coordination of certain rules concerning copyright and rights related to copyright applicable to satellite broadcasting and cable retransmission, COM(2002) 430 final, 26 July 2002, p. 7. See also IViR Report, The Recasting of Copyright & Related Rights for the Knowledge Economy, p. 25-26.

119 The facts in Premier League can be summarised as follows. The Football Association Premier League (FAPL) organised the first class football competition “Premier League” in England, it recorded the competition matches and it owned the “television broadcasting rights”. The recordings were sent to the broadcasters/licensees (images, ambient sound, logos, video sequences, on-screen graphics, music, English commentary). The (satellite) broadcasting rights (live transmission) were exploited via territorial licences, awarded based on an open tender procedure. The licences were mostly granted to national broadcasters, which obtained the exclusive right to broadcast the football matches on their national territories. Moreover, the licensees/broadcasters were obliged to prevent the reception of the broadcast outside the territory of broadcast. By consequence: (1) each broadcast (especially by satellite) had to be encrypted securely and (2) the broadcaster had to ensure that no decrypting device (decoder) was distributed outside the territory of broadcast. It was found that some bars and restaurants in the UK had bought foreign (Greek) decoders and used it to receive the Greek broadcast of the English football matches (for a lesser price). The decrypting devices were produced and distributed with the broadcaster’s consent (in Greece) but were used (in the UK) in infringement of the contractual conditions.

criterion (“country of origin”). The practice of reinstating the national borders and thus re-partitioning the common audiovisual market can be contained by reference to the freedom to provide services and competition law – provided that these restrictions are not necessary for the specific subject-matter of copyright.

The effects of “territoriality” are thus mitigated: the satellite broadcasting takes place in one country of origin, although it has effects beyond the Member State of origin. The Member States cannot define other “relevant acts” and consider these act part of the satellite broadcasting right, thus giving the author the possibility to exercise her right (in addition to the country of origin).

### **(ii) Exhaustion of the distribution right**

The Information Society Directive requires the Member States to grant a distribution right, i.e. in respect of the original of their works or of copies thereof the author has the right to authorise or prohibit any form of distribution to the public by sale or otherwise (art. 4(1) InfoSoc Directive). More precisely, the distribution right covers any form of distribution entailing a transfer of ownership (Cassina).

Without an exhaustion rule, the author would be able to exercise her exclusive right every time a material object incorporating her work changed owners. The author would thus be able to control not only the first commercialization of her work but also the derived, second-hand market. Moreover, the national exercise of the distribution right would have an effect on intra-Community movements of goods (imports/exports).

In order to avoid this corollary of the territoriality principle, it is provided that “*the distribution right shall not be exhausted within the Community in respect of the original or copies of the work, except where the first sale or other transfer of ownership in the Community of that object is made by the right holder or with his consent*” (art. 4(2) Information Society Directive). In other words, whenever an object incorporating the work has been put on the European market by the author or with her consent, she cannot object to the subsequent exploitation of the object in the form of sales or other transfers of ownership.

This principle is not applicable to immaterial exploitations protected under the right of communication to the public. It is expressly stated that the rights of communication to the public and of making available to the public (art 3(1)-(2) InfoSoc Directive) are not exhausted by any act of communication to the public or making available to the public as set out in art. 3 InfoSoc Directive<sup>120</sup>.

In other words, the authorised communication to the public of a work does not entail the exhaustion of the secondary exploitation of that work by means of a communication to the public. Any act of immaterial exploitation, protected by the right of communication to the public, requires the author’s consent, even if it is preceded by an act of immaterial exploitation that has been authorised by the author. For example, the authorisation given by the author to broadcast her work (primary communication) does not exempt the operator of a simulcasting service from obtaining her consent for including her work in this simulcasting service (secondary communication): the right of communication to the public has not been exhausted by the consent to the primary broadcast of the work.

However, since the CJEU’s decision in *UsedSoft* it is no longer inconceivable that the exhaustion rule be applied to copyright works (other than computer programs), downloaded with the right holder’s consent from a website. In this case, the software company offered its computer programs for permanent download to end-users, whose rights were described in the user licence. The Court decided that such download in conformity with the terms of the user licence resulted in a transfer of property and that this form of exploitation should be qualified as an act of distribution to the public, subject to exhaustion according to art. 4(2) CPD. The Court was careful to distinguish computer programs, regulated in the Computer Programs Directive as a *lex specialis*, from other works, dealt with in the Information Society Directive. At the same time, the Court and the Advocate-General rely on the WIPO Copyright Treaty for

---

120 See also IViR Report The Recasting of Copyright & Related Rights for the Knowledge Economy, p. 23-24.

this interpretation, which the Information Society Directive was meant to implement in the EU legal order (*UsedSoft*, par. 52). The *UsedSoft* ruling, qualifying an offer for download as an act of distribution subject (under certain conditions) to exhaustion, is currently restricted to computer programs, but a decision of the Court on a similar form of exploitation of other types of works is now more than ever welcome.

Traditionally it is understood that distribution right applies to tangible objects (save the *UsedSoft* ruling) and it is determined which material acts are restricted<sup>121</sup>. By consequence, it is clear how the exhaustion rule restricts the distribution right, i.e. by reference to a tangible object<sup>122</sup>. After a first act of distribution with the author's consent, this object can circulate freely within the EU.

Any effort to control the (extra) territorial effects of the making available right should similarly consist of both a definition of the restricted act under this right and a precise determination of the territorial effects which should be contained.

#### d) Conclusions on the territoriality principle

The principle that the national legislator is competent to regulate the events occurring on the national territory in copyright terms is not challenged, not even after several international and European initiatives to harmonise copyright protection.

The absence of a EU definition of the making available right leaves the Member States a considerable margin to interpret this restricted act under national copyright law (until the CJEU has filled in this gap) and to identify the relevant elements taking place on their territories.

**CJEU decisions.** The “national territoriality” principle stands in the decisions of the CJEU. By principle the Member States are still competent to regulate on their territories and to control the events occurring on their territories. In “*Lagardère*”, the conduct engaged on the national territory led to an obligation to pay an equitable remuneration, the rate of the equitable remuneration was calculated in function of the value of the (national) use and the remunerations due in distinct Member States cannot be compensated. In “*Stichting De ThuisKopie*”, the harm resulting from reproductions (private copies) on a national territory – located by the residence of the final user, created an obligation to pay a fair compensation to the authors, recovered in the form of a levy. It seems however that the Court is inclined to seek a balance with the requirement of a high level of protection and an efficient enforcement of copyright.

The satellite broadcasting right constitutes a deviation from this national territoriality principle. Its wider territorial scope entails that the value of the use (according to which the amount of the licence fee is assessed) is not restricted to the national territory of the Member State of broadcast but to the audience present in the Member States of broadcast and reception (*Satellite and Cable Directive*, rec. 17).

However, in “*Stichting De ThuisKopie*”, the effect of the territoriality principle was moderated and a Member State is allowed to interpret its own norms (in effect) as to regulate the behaviour of a person residing in another Member State in relation to acts occurring in another Member State, if this is necessary to ensure a high protection for the authors and the execution of that Member State's obligation to ensure the effective compensation of the harm occurring on its territory as a consequence of an exception in that Member State's copyright legislation. The facts of this case being quite specific, it is uncertain how the teaching of this decision could be generalised.

In *Donner* and *Sportradar*, the territoriality principle was (implicitly) applied to complex operations, with constitutive acts in several Member States. In both cases the Court found relevant acts as parts of such distribution / communication process in the Member States of the referring courts. In *Donner*, the

---

121 Cf. Cassina, *Donner*.

122 This is less clear in the *UsedSoft* ruling, which extends the exhaustion of the distribution right to the functional or economic equivalent of the originally distributed copy, on condition that this first copy is made unusable by the time a copy is sold.

outcome determined whether the criminal law provisions could be applied in Germany. In *Sportradar*, this allowed the UK courts to find jurisdiction to rule on the liability of one of the parties.

Various **criteria** have been applied to trigger the “territoriality”. In *Lagardère*, it was the material act of broadcasting that determined where the obligation to pay the single equitable remuneration was due. The rate of the fee by contrast should be determined based on the presence of a (potential or actual) public on a national territory or the exploitation of a work on a national territory. The fact of the exploitation was not relevant to establish an obligation to pay a remuneration but it was taken into account to determine the amount of the remuneration. Where a material act of broadcast takes place on the territory of a Member State but the broadcast is not actually exploited on that national territory, then in principle an obligation to pay the remuneration arises but its rate should be determined according to the value of the exploitation (i.e. result in a low rate). In *Stichting De Thuiskopie*, it was the occurrence of harm on a territory, at the residence of the final user who causes the harm that located the conduct on the territory of a Member State.

The Court applied a different criterion in *Donner* and *Sportrada*. After its ruling in *L’Oréal*, it applied the criterion of “intended target” of the user of the protected subject matter. In *Donner* it was established that the essential parts of the cross-border distribution process took place in the Member State of destination, where the public was targeted. Elements that suggested such targeting behaviour were *inter alia* a website and advertisement in German and the existence of a delivery and payment system extending to the German territory. In *Sportradar* it was decided that the act of sending was protected under the reutilisation right and that it could be localised in the Member State where the public was targeted. The mere accessibility of the data in a Member State was not sufficient to establish localisation in that Member State. In this case however it was derived from the nature of the data, contracts with betting service operators, perhaps the basis of the remuneration scheme and the language of the service, which was different from the language of the Member State where Sportradar pursued its activities. Interestingly, in *Sportradar*, the service provider did not seem to perform any material act in the Member State of destination: it had its servers in another Member State and it transmitted the data at the request of users, residing in the Member State of destination. It must be emphasised however that the Court allows that several restricted acts can be found in several Member States.

**Uncertainty re making available right.** The absence of a definition of the making available right creates some legal uncertainty as to the territorial reach of the online accessibility of protected subject matter. Different elements of this complex act could be considered relevant to establish the application of the national right of making available to the public: the availability on a server or the transmission to a Member State, even accessibility of the work may be considered a relevant element for the making available right. By consequence, if all Member States are free to determine which element of the complex act is relevant to establish an act of making available, then each could subject this constitutive part to the prior authorisation of the author (and to the corresponding payment of a licence fee – cf. *Premier League*, par. 110). The Member States could define the same or different criteria to apply their national making available right. At least in theory, this would lead to the accumulation of, firstly, distinct acts of making available under the national copyright legislations concerned. Secondly, there could be an accumulation of distinct acts of reproduction and (other) communication to the public. Without a clarification of this restricted act, its relation to the other exclusive economic rights and the localisation criterion, the territorial application of national copyright laws remains speculative.

In the following section it will be examined how this uncertainty in terms of definition and localisation of the making available right affects other legal issues, in particular the conflicts of laws principles, the authorship and ownership rules and the accumulation with the reproduction right.

### C. Legal issues/consequences

In section A of this Study, it has been established that the making available right is not defined in the InfoSoc Directive and that acts protected under this right may be localised according to different criteria, found in the cases decided by the Court of Justice. In this section it will be examined how this uncertain scope affects other copyright issues. It will be examined how the making available right should be



applied together with the rules on conflict of laws, with the national rules on authorship and ownership and with the reproduction right. The purpose of this exercise is to have a more precise idea of the actual effects of this uncertainty. This will allow us to conclude on the bottlenecks the actual making available right presents to various stakeholders (in particular right holders, service providers, end-users).

## 1. Conflict of laws

Because of the territoriality of copyright, the exercise of the making available right may raise issues of private international law, hence it can generate situations with cross-border elements. Yet, when a legal dispute contains cross-border elements, different arguments may be relied upon to justify the competence of different national courts and/or the application of different national laws.

Private international law issues have long been neglected in the field of copyright. It was thought that they could be avoided through the international copyright conventions and through the harmonisation of legislation<sup>123</sup>. The development of essentially “international” technologies, i.e. satellite broadcasting and the Internet, has reminded of the importance of private international law with regards to copyright. Indeed, due to its worldwide scope, the use of the Internet reveals many cross-border situations: when the user uploads a protected work on Internet, it is potentially accessible all over the world and a protected act may occur in more than one country.

We have established before that uncertainty exists regarding both the definition of the making available right and the criteria to localise protected acts within the EU. In this chapter we will examine how this situation is affected by private international law rules. We will successively examine the rules of jurisdiction (*sub a*) and applicable laws (*sub b*) with regard to the making available right.

### a) Jurisdiction

Despite several attempts, there is no international instrument yet that harmonizes the rules on jurisdiction for the whole world. The Hague Conference on Private international law tried to fix international rules and proposed a *draft Convention on Jurisdiction and Foreign Judgments in Civil and Commercial Matters* but the project failed in 2003 as no consensus could be reached.

Except in Europe, the conflicts of jurisdictions are therefore ruled by each country’s private international law rules, so a whole set of national systems coexists. Different groups of scholars have tried to draw worldwide principles on conflict of laws in intellectual property. The American Law Institute adopted a set of rules in 2007 to settle the conflict of laws issues in intellectual property law (ALI Principles). In 2011, the European Max Planck Group on Conflict of Laws in Intellectual Property presented a list of principles covering international jurisdiction, the applicable law, and recognition and enforcement of foreign judgments in the field of intellectual property (CLIP Principles)<sup>124</sup>. However, these principles lack authoritative force. They can however be used as guidelines by legislators and judges.

In the European Union, the Member states have adopted Council Regulation (EC) No 44/2001 of 22 December 2000 on jurisdiction and the recognition and enforcement of judgments in civil and commercial matters<sup>125</sup>, commonly known as *Brussels I Regulation*<sup>126</sup>.

---

123 A. LUCAS, “Applicable law in copyright infringement cases in the digital environment”, 1.

124 The text of the CLIP Principles is available at [http://www.cl-ip.eu/files/pdf2/Final\\_Text\\_1\\_December\\_2011.pdf](http://www.cl-ip.eu/files/pdf2/Final_Text_1_December_2011.pdf)

125 Council Regulation (EC) No 44/2001 of 22 December 2000 on jurisdiction and the recognition and enforcement of judgments in civil and commercial matters, OJ L 12, 16 January 2001, p. 1–23.

126 In addition to Brussels I, two other instruments remain in force in Europe: the Convention on jurisdiction and the enforcement of judgments in civil and commercial matters (“Brussels Convention”) which applies between the Member States of Brussels I and Denmark; the Convention on jurisdiction and the recognition and enforcement of judgments in civil and commercial matters (“Lugano Convention”) which applies between the Members States of the European Union and the EFTA countries.

According to the article 1, *Brussels I* applies in all the Member States of the European Union in civil and commercial matters, with the exception of Denmark.

Article 2 of the Brussels I Regulation provides a general rule assigning jurisdiction to the Courts of the Member State in which a person is domiciled, whatever her nationality.

Furthermore, the Brussels I Regulation provides additional rules for national judges to treat issues on jurisdiction with regard to provisional or protective measures **(i)** contractual matters **(ii)** and non-contractual matters **(iii)**.

### **(i) Provisional or protective measures**

According to article 31 of the *Brussels I* Regulation, provisional or protective measures can be pursued in all the Member States, even if there is no link between the Member State selected and the infringing act<sup>127</sup>. That provision deals with the granting of provisional measures in contractual as well as in non-contractual matters.

Article 31 is designed to apply regardless of any jurisdiction as to the substance, so that it applies where a claim for provisional, including protective, measures is brought before a court other than the court which has jurisdiction as to the substance. Consequently, the courts of a Member State are authorised to rule on a claim for a provisional measure even if the courts of another Member State have jurisdiction as to the substance of the matter under the Regulation Brussels I: In *Solvay*, it was admitted that a national court can grant a provisional cross-border injunction provided that the court does not issue a final decision on the validity of the patent and the validity of the patents is not seriously challenged<sup>128</sup>. It is uncertain to which extent such cross border measures are available for copyright infringements. Furthermore, the mere fact that proceedings have been commenced on the substance of the case in another Member State does not deprive a court of a Member State of its jurisdiction under article 31<sup>129</sup>.

That provision is intended to avoid causing loss to the parties as a result of the long delays inherent in international proceedings. As it lays down an exception to the general rule set up by article 2 of the Regulation, article 31 has to be interpreted strictly<sup>130</sup>. According to the Court of Justice, it applies to measures which are intended to preserve a factual or legal situation so as to safeguard rights the recognition of which is sought elsewhere<sup>131132</sup>. As a consequence, it is contested whether article 31 may justify the granting of measures such as orders of description resulting from infringements to IP rights in a Member State different from the Member State having jurisdiction to rule on the substance of the infringement: that provision would indeed only apply to measures intended to preserve the substantive claim in law, and not to the performance of procedural measures such as the taking of evidence<sup>133134</sup>.

127 Article 31 provides: Application may be made to the courts of a Member State for such provisional, including protective, measures as may be available under the law of that State, even if, under this Regulation, the courts of another Member State have jurisdiction as to the substance of the matter.

128 CJEU 12 July 2012, Case C-616/10, *Solvay SA v Honeywell Fluorine Products Europe BV, Honeywell Belgium NV, Honeywell Europe NV*.

129 CJEU 17 November 1998, Case C-391/95, *Van Uden Maritime BV, trading as Van Uden Africa Line v Kommanditgesellschaft in Firma Deco-Line and Another (Van Uden)*.

130 CJEU 28 April 2005, Case C-104/03, *St. Paul Dairy Industries NV v Unibel Exser BVBA (St. Paul)*.

131 CJEU 26 March 1992, Case C-261/90, *Mario Reichert, Hans-Heinz Reichert and Ingeborg Kockler v Dresdner Bank AG*.

132 Recital 25 of the new Regulation Brussels Ibis mentions that the notion of provisional, including protecting, measures should not include measures which are not of a protective nature, such as measures ordering the hearing of a witness.

133 Opinion delivered by the Advocate General KOKOTT delivered on 18 July 2007 in Case C-175/06, *Alessandro Tedesco v Tomasoni Fittings Srl and RWO Marine Equipment Ltd*.

134 Recital 25 of the new Regulation Brussels Ibis resolves that debate and states that the notion of provisional, including protective, measures should include protective orders aimed at obtaining information or preserving evidence as referred to in

The Court of Justice holds that the granting of provisional or protective measures is conditional on, *inter alia*, the existence of a real connecting link between the subject-matter of the measures sought and the territorial jurisdiction of the Contracting State of the court before which those measures are sought<sup>135</sup>. On that condition, provisional measures may be sought in a Member State to be executed in another Member State. However, such measures will be subject to an authorization for enforcement in the second Member State<sup>136</sup>, based on art. 39 of Brussels I.

The new Regulation n° 1215/2012 (*Brussels Ibis*) – which will apply from 10 January 2015 – will facilitate the circulation of judgments, including provisional or protective measures, as it eliminates the requirement of authorization for enforcement in other Member States<sup>137</sup>. However, according to *Brussels Ibis*, where provisional measures will be ordered by a court of a Member State not having jurisdiction as to the substance of the matter, the effect of such measures will have to be confined to the territory of that Member State<sup>138</sup>. On the contrary, provisional and protective measures ordered in a country having jurisdiction as to the substance will have to be recognised and enforced in other Member States<sup>139</sup>.

## (ii) **Contractual disputes**

It seems that there are few issues of private international law in disputes that relate to the enforcement of contracts in the field of copyright.

Indeed, the contract generally contains a specific clause fixing jurisdiction and, according to the general provision contained in article 23 of the *Brussels I* Regulation, any claim has to be brought before the courts mentioned in that clause of the contract<sup>140</sup>. A similar provision has been proposed at the WIPO forum on private international law and intellectual property<sup>141</sup>.

---

Articles 6 and 7 of Directive 2004/48/EC of the European Parliament and of the Council of 29 April 2004 on the enforcement of intellectual property rights, OJ L 157, 30 April 2004, p. 45–86.

135 Van Uden.

136 A. NUYTS, "Les mesures provisoires dans le Règlement Bruxelles Ibis", R.D.C.-T.B.H., 2013, 350.

137 Regulation (EU) No 1215/2012 of the European Parliament and of the Council of 12 December 2012 on jurisdiction and the recognition and enforcement of judgments in civil and commercial matters, OJ L 351, 20.12.2012, p. 1–32.

138 Rec. 33.

139 A. NUYTS, "Les mesures provisoires dans le Règlement Bruxelles Ibis", 351.

140 Article 23 provides:

1. If the parties, one or more of whom is domiciled in a Member State, have agreed that a court or the courts of a Member State are to have jurisdiction to settle any disputes which have arisen or which may arise in connection with a particular legal relationship, that court or those courts shall have jurisdiction. Such jurisdiction shall be exclusive unless the parties have agreed otherwise. Such an agreement conferring jurisdiction shall be either:

(a) in writing or evidenced in writing; or

(b) in a form which accords with practices which the parties have established between themselves; or

(c) in international trade or commerce, in a form which accords with a usage of which the parties are or ought to have been aware and which in such trade or commerce is widely known to, and regularly observed by, parties to contracts of the type involved in the particular trade or commerce concerned.

2. Any communication by electronic means which provides a durable record of the agreement shall be equivalent to "writing".

3. Where such an agreement is concluded by parties, none of whom is domiciled in a Member State, the courts of other Member States shall have no jurisdiction over their disputes unless the court or courts chosen have declined jurisdiction.

(...)

141 Article 4.1 of the Draft Convention on jurisdiction and recognition of judgments in intellectual property matters, proposed at the WIPO Forum in Geneva on 30 and 31 January 2001:

1. If the parties have agreed that a court or courts of a Contracting State or an arbitral forum shall have jurisdiction to settle any dispute which has arisen or may arise in connection with a particular legal relationship, that court or those courts shall have jurisdiction, and that tribunal shall have jurisdiction, and its jurisdiction shall be exclusive unless the parties have agreed otherwise. Where an agreement having exclusive effect designates a court or courts of a non-Contracting State, or an arbitral forum, the courts

That principle is positive for the right holders, as well as for the users, as they have the guarantee that the courts they have chosen will have jurisdiction. However, sometimes the author or the user does not really have the opportunity to negotiate the contract. In that case, she is forced to accept the will of her contracting partner regarding jurisdiction.

If the contracting partners did not regulate the jurisdiction in the contract, then *Brussels I* provides alternative principles. First of all, as we mentioned it above, article 2 gives jurisdiction to the courts of the defendant's Member State in any circumstances<sup>142</sup>.

Furthermore, according to article 5(1)(a) of the *Brussels I* Regulation, the action can also be brought in the Member State of the place of performance of the obligation<sup>143</sup>. Art. 5.1.b stipulates that the place of performance of the obligation is the place where the goods were delivered or should have been delivered in the case of the sale of goods and the place where the services were provided or should have been provided in the case of the provision of services. In a judgment dated 23<sup>rd</sup> April 2009<sup>144</sup>, the Court of justice of the European Union held that a contract under which the owner of an intellectual property right grants its contractual partner the right to use the right in return for remuneration may not be interpreted as a contract for the provision of services in the meaning of article 5(1)(b), as the owner of the intellectual property right does not perform any active conduct in granting a right to use that property<sup>145</sup>. According to the Court, such contract nevertheless falls under the scope of article 5(1)(a). Consequently, jurisdiction has to be determined in accordance with the law governing the obligation which arises under the contract and the non-performance of which is relied upon in support of the action. The place where that obligation has or should be performed is to be determined with respect to the conflict rules of the court before which the proceedings have been brought<sup>146</sup>.

These rules apply to contracts dealing with the making available right:

- According to article 23 of the *Brussels I* Regulation, any dispute relating to the enforcement of a contract according to which the right holder would have allowed the right to make its work available has to be brought before the courts elected in the contract. It can be a positive rule for the right holders provided that they really have the opportunity to negotiate that choice.
- If the contract does not regulate the issue of jurisdiction, then the claimant has the choice to bring his claim in the country of the defendant (article 2) or in the country where the making available act should or has been performed (article 5.1.a). That location has to be determined according to the national law governing that obligation. We find that last criterion uncertain for both contracting

in Contracting States shall decline jurisdiction or suspend proceedings unless the court or courts chosen have themselves declined jurisdiction.

142 Article 2 of the Brussels I Regulation:

Subject to this Regulation, persons domiciled in a Member State shall, whatever their nationality, be sued in the courts of that Member State.

143 Article 5.1. of the Brussels I Regulation:

A person domiciled in a Member State may, in another Member State, be sued:

1. (a) in matters relating to a contract, in the courts for the place of performance of the obligation in question;

(b) for the purpose of this provision and unless otherwise agreed, the place of performance of the obligation in question shall be:

- in the case of the sale of goods, the place in a Member State where, under the contract, the goods were delivered or should have been delivered,

- in the case of the provision of services, the place in a Member State where, under the contract, the services were provided or should have been provided,

(c) if subparagraph (b) does not apply then subparagraph (a) applies;

144 CJEU, 23 April 2009, Case C-533/07, Falco Privatstiftung and Thomas Rabitsch v Gisela Weller-Lindhorst, ECR, 2009, I, 03327.

145 Opinion of the Advocate general TRSTENJAK of 27 January 2009 in the case C-533/07, Falco Privatstiftung, par. 59.

146 Cfr. CJEU, 6 October 1976, C-14/76, ECR 1976, I, 1497; CJEU, 6 October 1976, C-12/76, ECR 1976, I, 1473.

partners with regard to the making available right, as the protected act can hardly be located in one single place due to its uncertain definition. Taking into account the recent case-law of the Court of Justice, we can anticipate that the act of making available will be seen as performed in the country whose public is targeted by the contract.

**(iii) Non-contractual disputes**

The issues related to jurisdiction in the field of copyright mainly arise in non-contractual disputes.

Articles 2 and 5.3 of the *Brussels I* Regulation provide rules to settle such issues. We will not treat the rule contained in article 6.1 of the *Brussels I* Regulation<sup>147</sup> in the present Study. That provision specifically applies to claims directed against several defendants who are located in different Member States<sup>148</sup>.

Complementary to the rule provided under article 2 of the *Brussels I* Regulation, according to which the claimant may always sue the defendant before the Courts of the Member State where he has his domicile, article 5.3 contains an additional rule providing jurisdiction to the Courts of the Member State “*where the harmful event occurred or may occur*”.

This is a factual localisation criterion that applies independently from the debate on the substance, even if both issues are related<sup>149</sup>: the localisation of the material act on the substance may influence the application of the rules of private international law, which nevertheless apply autonomously.

According to the CJEU, the purpose of article 5.3 of the *Brussels I* Regulation is to take into account the existence of a particularly close connecting factor between a dispute and the court which may be called upon to hear it<sup>150</sup>.

However, in case of complex infringement, *i.e.* situations where the infringing act is located in different countries, the use of the wording “*place where the harmful event occurred*” is unclear and causes a lack of legal certainty for the right holders as well as for the users/alleged infringers. Indeed, the event giving rise to an infringement of the making available right and the resulting damage may occur in different countries, so the legal provision does not answer the question which element has to be taken into account as connecting factor to determine jurisdiction.

In *Mines de Potasse*, the Court of justice has interpreted the wording “*place where the harmful event occurred*” as an option for the plaintiff to start proceedings either at the place where the damage occurred or at the place of the event giving rise to it. When those places are located in different Member States, the plaintiff has an option for the introduction of his claim:

*“Taking into account the close connection between the component parts of every sort of liability, it does not appear appropriate to opt for one of the two connecting factors mentioned to the exclusion of the other, since each of them can, depending on the circumstances, be particularly helpful from the point of view of the evidence and of the conduct of the proceedings.”*

---

147 Article 6.1 provides:

A person domiciled in a Member State may also be sued:

1. where he is one of a number of defendants, in the courts for the place where any one of them is domiciled, provided the claims are so closely connected that it is expedient to hear and determine them together to avoid the risk of irreconcilable judgments resulting from separate proceedings;

148 For an example of the enforcement of that provision in the field of copyright, see CJEU, 1 December 2011, C-145/10, Painer.

149 Opinion of the Advocate general JÄÄSKINEN in Pinckney par. 45; E. TREPPOZ, “Droit européen de la propriété intellectuelle”, R.T.D.E., 2011, 851.

150 CJEU, 30 November 1976, Case C-21/76, Handelskwekerij G. J. Bier BV v Mines de potasse d'Alsace, ECR, 1976, 01735 (SAMines de potasse).

*To exclude one option appears all the more undesirable in that, by its comprehensive form of words, Article 5 (3) of the Convention covers a wide diversity of kinds of liability.*

*Thus the meaning of the expression 'place where the harmful event occurred' in Article 5 (3) must be established in such a way as to acknowledge that the plaintiff has an option to commence proceedings either at the place where the damage occurred or the place of the event giving rise to it.*"

The Court of justice confirmed that interpretation of article 5.3 in *Shevill*<sup>151</sup>. That case resulted from the distribution of a libellous newspaper article published in the United Kingdom, to different Member States, causing damage in each country where the paper was distributed. The Court first reminded that the victim has the option to bring her entire claim in the country of the event giving rise to the damage:

*"In the case of a libel by a newspaper article distributed in several Contracting States, the place of the event giving rise to the damage, within the meaning of those judgments, can only be the place where the publisher of the newspaper in question is established, since that is the place where the harmful event originated and from which the libel was issued and put into circulation.*

*The court of the place where the publisher of the defamatory publication is established must therefore have jurisdiction to hear the action for damages for all the harm caused by the unlawful act."*

Then, the Court held that the damage occurs in the places where the publication is distributed, so the courts of each Member State in which the publication is distributed and in which the victim claims to have suffered injury to her reputation also have jurisdiction to rule on the injury caused in that State:

*"As the Court held in Mines de Potasse d'Alsace, the plaintiff must consequently have the option to bring proceedings also in the place where the damage occurred, since otherwise Article 5(3) of the Convention would be rendered meaningless.*

*The place where the damage occurred is the place where the event giving rise to the damage, entailing tortious, delictual or quasi-delictual liability, produced its harmful effects upon the victim.*

*In the case of an international libel through the press, the injury caused by a defamatory publication to the honour, reputation and good name of a natural or legal person occurs in the places where the publication is distributed, when the victim is known in those places."*

In *Shevill*, the Court of justice brought an important limitation to the jurisdiction of the courts of the countries where the damage occurs, as it ruled that these courts are competent only for the damage caused in that country:

*"In accordance with the requirement of the sound administration of justice, the basis of the rule of special jurisdiction in Article 5(3), the courts of each Contracting State in which the defamatory publication was distributed and in which the victim claims to have suffered injury to his reputation are territorially the best placed to assess the libel committed in that State and to determine the extent of the corresponding damage."*

The Court of justice has recently applied the principles resulting from the rulings *Mines de Potasse* and *Shevill* to infringing acts committed on Internet. The case *eDate Advertising*<sup>152</sup> dealt with online publication of newspaper articles infringing two individuals' privacy. These publications were causing damages to these persons in many countries, including the country where the respective publishers of the article were located, the country where the victims were domiciled, and other countries all over the world.

---

151 CJEU 7 March 1995, Case C-68/93, Fiona Shevill, Ixora Trading Inc., Chequepoint SARL and Chequepoint International Ltd v Presse Alliance SA, ECR, 1995, I, 00405 (Shevill).

152 CJEU 25 October 2011, Joined cases C-509/09 and C-161/10, eDate Advertising GmbH v X (C-509/09) and Olivier Martinez and Robert Martinez v MGN Limited (C-161/10) (eDate Advertising).

In its decision, the Court pointed out the specific issues of Internet and the difficulty to apply the existing case-law relating to article 5.3:

*“(…) the placing online of content on a website is to be distinguished from the regional distribution of media such as printed matter in that it is intended, in principle, to ensure the ubiquity of that content. That content may be consulted instantly by an unlimited number of internet users throughout the world, irrespective of any intention on the part of the person who placed it in regard to its consultation beyond that person’s Member State of establishment and outside of that person’s control.*

*It thus appears that the internet reduces the usefulness of the criterion relating to distribution, in so far as the scope of the distribution of content placed online is in principle universal. Moreover, it is not always possible, on a technical level, to quantify that distribution with certainty and accuracy in relation to a particular Member State or, therefore, to assess the damage caused exclusively within that Member State”*

The Court stressed the necessity to adapt the existing criterion of the place where the damage occurs. For the first time, it has allowed a person to bring a complaint in respect to all the damage caused in the country where that person has her centre of interests, even if that country is not the place of the event giving rise to the damage, neither the place where the defendant is domiciled:

*“The connecting criteria referred to in paragraph 42 of the present judgment must therefore be adapted in such a way that a person who has suffered an infringement of a personality right by means of the internet may bring an action in one forum in respect of all of the damage caused, depending on the place in which the damage caused in the European Union by that infringement occurred. Given that the impact which material placed online is liable to have on an individual’s personality rights might best be assessed by the court of the place where the alleged victim has his centre of interests, the attribution of jurisdiction to that court corresponds to the objective of the sound administration of justice, referred to in paragraph 40 above.*

(…)

*The jurisdiction of the court of the place where the alleged victim has the centre of his interests is in accordance with the aim of predictability of the rules governing jurisdiction (see Case C-144/10 BVG [2011] ECR I-0000, paragraph 33) also with regard to the defendant, given that the publisher of harmful content is, at the time at which that content is placed online, in a position to know the centres of interests of the persons who are the subject of that content. The view must therefore be taken that the centre-of-interests criterion allows both the applicant easily to identify the court in which he may sue and the defendant reasonably to foresee before which court he may be sued (see Case C-533/07 Falco Privatstiftung and Rabitsch [2009] ECR I-3327, paragraph 22 and the case-law cited).*

*Moreover, instead of an action for liability in respect of all of the damage, the criterion of the place where the damage occurred, derived from Shevill and others, confers jurisdiction on courts in each Member State in the territory of which content placed online is or has been accessible. Those courts have jurisdiction only in respect of the damage caused in the territory of the Member State of the court seized.”*

The plaintiff still has the alternative to sue the person liable for the infringing act in the country of the event giving rise to that act, or in each country where the damage occurs. With regard to the place where the damage occurs, the Court considered that this criterion provides jurisdiction to all the countries where the content is accessible:

*“Moreover, instead of an action for liability in respect of all of the damage, the criterion of the place where the damage occurred, derived from Shevill and Others, confers jurisdiction on courts in each Member State in the territory of which content placed online is or has been accessible. Those courts have jurisdiction only in respect of the damage caused in the territory of the Member State of the court seized”.*

This means that all the Member States will have jurisdiction with regard to the damage caused on their territory, if the website is accessible all over Europe and if that accessibility may generate a damage<sup>153</sup>. According to E. TREPPOZ, the criterion of accessibility might even provide jurisdiction to Member states where no real prejudice is felt<sup>154</sup>. It should be observed that the Court seems to have nuanced this interpretation in more recent cases (*infra*).

The judgment in *e-Date Advertising* gives the plaintiff the opportunity to opt for a complementary connecting factor and to sue the person liable for the infringing act in the plaintiff's country with regard to the entire damage caused. According to the Court of justice, that connecting factor is based on the objective of the sound administration of justice and on the aim of predictability of the rules governing jurisdiction. These criteria can be found in the recitals 11 and 12 of the *Brussels I* Regulation<sup>155</sup>.

If that new connecting factor was applied to acts infringing the making available right, it would allow the right holder to sue the counterfeiter in the country where the right holder has the center of his interests to claim compensation for the whole resulting prejudice<sup>156</sup>. It would be a regime very favourable to the interests of the right holders. The scope of the *e-Date Advertising* decision is however strictly limited to the protection of personality rights, so that its extension to the sphere of copyright is contested<sup>157158</sup>.

Commentators have criticized the interpretation of article 5.3 of the *Brussels I* Regulation provided by the Court of justice in *eDate Advertising*, because of its lack of legal certainty for the users of internet:

*“La compétence universelle et systématique décrite dans les paragraphes précédents est-elle satisfaisante? Du point de vue des intérêts de l’auteur, la réponse est affirmative, car ce dernier disposera d’une grande variété de choix quant à la ou aux juridiction(s) à saisir (forum shopping). A contrario, du point de vue du défendeur, cette solution est très rude : il pourra être assigné n’importe où (en Europe notamment par le biais de l’article 5 (3), mais également dans le reste du monde, pour autant qu’une disposition nationale similaire existe). Le risque pour un défendeur de se faire attirer devant n’importe quelle juridiction « exotique », par le seul fait que son site internet soit consultable à partir du territoire sur lequel est établie cette juridiction, est réel.”*<sup>159</sup>

The case *Wintersteiger*<sup>160</sup> gave the Court the opportunity to apply article 5.3 to counterfeiting acts on internet and to delineate the scope of the doctrine *e-Date Advertising*. That case resulted from the unauthorized use of a trademark through a web search engine focused on a country different from the country where the trademark was registered. The Court reminded the option for the holder of a trade mark to sue the advertiser in the country of the event giving rise to the infringing act or in the country where the damage occurs.

153 J-P MOINY, "Droit international et droit européen – L'intention "géodéterminée" : un facteur de rattachement confirmé ?", R.D.T.I., 2012, n° 48-49, 217.

154 E. TREPPOZ, *op. cit.*, 853.

155 Recitals 11 and 12 provide:

(11) The rules of jurisdiction must be highly predictable and founded on the principle that jurisdiction is generally based on the defendant's domicile and jurisdiction must always be available on this ground save in a few well-defined situations in which the subject-matter of the litigation or the autonomy of the parties warrants a different linking factor. The domicile of a legal person must be defined autonomously so as to make the common rules more transparent and avoid conflicts of jurisdiction.

(12) In addition to the defendant's domicile, there should be alternative grounds of jurisdiction based on a close link between the court and the action or in order to facilitate the sound administration of justice.

156 J-P MOINY, "Droit international et droit européen – L'intention "géodéterminée" : un facteur de rattachement confirmé ?", 219-221.

157 Opinion of Advocate general Jaaskinen in *Pinckney*, par. 69.

158 J.C. GINSBURG, "Where does the act of "making available" occur?", The Media Institute, 29 October 2012, <http://www.mediainstitute.org/IPI/2012/102912.php>. See however E. TREPPOZ, *op. cit.*, 847-853.

159 F. LEJEUNE, "Contrefaçon, internet et compétence internationale : le droit d'auteur échapperait-il à la théorie de la focalisation ?", AM 2011/4, 427.

160 CJEU, 26 April 2012, Case C-523/10, *Wintersteiger AG v Products 4U Sondermaschinenbau GmbH*.



As to the event giving rise to a damage caused through the use of internet, the Court denied the place of establishment of a server as the place where the event giving rise to the infringing act occurs. The Court stated that the infringement takes place where the activation of the technical process displaying the infringing content is decided, in this case the establishment of the advertiser:

*“In the case of an alleged infringement of a national trade mark registered in a Member State because of the display, on the search engine website, of an advertisement using a keyword identical to that trade mark, it is the activation by the advertiser of the technical process displaying, according to pre-defined parameters, the advertisement which it created for its own commercial communications which should be considered to be the event giving rise to an alleged infringement, and not the display of the advertisement itself.”*

*As the Court has already held in the context of interpretation of the directive to approximate the laws of the Member States relating to trade marks, it is the advertiser choosing a keyword identical to the trade mark, and not the provider of the referencing service, who uses it in the course of trade (Google France and Google, paragraphs 52 and 58). The event giving rise to a possible infringement of trade mark law therefore lies in the actions of the advertiser using the referencing service for its own commercial communications.*

*It is true that the technical display process by the advertiser is activated, ultimately, on a server belonging to the operator of the search engine used by the advertiser. However, in view of the objective of foreseeability, which the rules on jurisdiction must pursue, the place of establishment of that server cannot, by reason of its uncertain location, be considered to be the place where the event giving rise to the damage occurred for the purpose of the application of Article 5(3) of Regulation No 44/2001.*

*By contrast, since it is a definite and identifiable place, both for the applicant and for the defendant, and is therefore likely to facilitate the taking of evidence and the conduct of the proceedings, it must be held that the place of establishment of the advertiser is the place where the activation of the display process is decided.” (emphasis added)*

The Court then decided, with regard to the criterion of the place where the damage occurs, that it gives jurisdiction to the courts of the Member State in which the right at issue is registered to determine all the damage allegedly caused to the proprietor of the protected right. This is based once again on the objective of foreseeability and that of sound administration of justice:

*“With regard to jurisdiction to hear a claim of infringement of a national mark in a situation such as that in the main proceedings, it must be considered that both the objective of foreseeability and that of sound administration of justice militate in favour of conferring jurisdiction, in respect of the damage occurred, on the courts of the Member State in which the right at issue is protected.*

*It is the courts of the Member State in which the trade mark at issue is registered which are best able to assess, taking account of the interpretation of Directive 2008/95 in, inter alia, Cases C-236/08 to C-238/08 Google France and Google [2010] ECR I-2417, and Case C-324/09 L’Oréal and Others [2011] ECR I-0000, whether a situation such as that in the main proceedings actually infringes the protected national mark. Those courts have the power to determine all the damage allegedly caused to the proprietor of the protected right because of an infringement of it and to hear an application seeking cessation of all infringements of that right.” (emphasis added)*

Nevertheless, we doubt that this principle could apply to the making available right: contrary to trademarks, copyright does not imply a registration process, so the criterion of the country where the IP right is registered cannot apply.

The Court went further in the case *Football Dataco*, opposing an organisation managing a database containing a compilation of data’s on football matches in England and Wales and Sportradar, a German company which provides to betting companies results and other statistics relating to the English league matches live via the internet. Football Dataco brought proceedings against Sportradar in England

claiming that the German company was infringing to the sui generis right on its database. Sportradar challenged the jurisdiction of the English courts and alleged that the infringing act was committed in a Member State other than the United Kingdom, at the place where Sportradar's servers are located.

Even if the prejudicial issue did not treat the question of jurisdiction, the reasoning of the Court of Justice has to be taken into account. The Court indeed explained how to localise the protected act by analysing rules of substantive law and rules of private international law. Doing so, it rejected Sportradar's arguments trying to assimilate the place where the harmful event occurs to the place where the server from which the data's are sent is situated, and ruled in favour of the approach focused on the public of the Member State to which the user is directing his offer, considering that it is the place where the act of reutilisation of the data's happens:

*"The localisation of an act of re-utilisation in the territory of the Member State to which the data in question is sent depends on there being evidence from which it may be concluded that the act discloses an intention on the part of its performer to target persons in that territory.*

(...)

*In the light of the above considerations, the answer to the question is that Article 7 of Directive 96/9 must be interpreted as meaning that the sending by one person, by means of a web server located in Member State A, of data previously uploaded by that person from a database protected by the sui generis right under that directive to the computer of another person located in Member State B, at that person's request, for the purpose of storage in that computer's memory and display on its screen, constitutes an act of 're-utilisation' of the data by the person sending it. That act takes place, at least, in Member State B, where there is evidence from which it may be concluded that the act discloses an intention on the part of the person performing the act to target members of the public in Member State B, which is for the national court to assess."*

As to the place of the damage, the Court then diverged from the theory of accessibility it had raised in *eDate Advertising* and expressed that the accessibility of a website in a Member State is not a sufficient condition to localize the protected acts in that country:

*"The mere fact that the website containing the data in question is accessible in a particular national territory is not a sufficient basis for concluding that the operator of the website is performing an act of re-utilisation caught by the national law applicable in that territory concerning protection by the sui generis right.*

*If the mere fact of being accessible were sufficient for it to be concluded that there was an act of re-utilisation, websites and data which, although obviously targeted at persons outside the territory of the Member State concerned, were nevertheless technically accessible in that State would wrongly be subject to the application of the relevant law of that State.*

J. GINSBURG approves the reasoning of the Court as it makes sense on an economic point of view "and avoids the pitfalls of a point of attachment based solely on the place(s) of receipt of the communication"<sup>161</sup>.

So far, the Court of justice has never had to treat issues regarding jurisdiction in disputes related to copyright infringement on internet. Meanwhile, it has received a prejudicial issue aiming at the interpretation of article 5.3 of the Brussels I Regulation because of the unauthorized reproduction and distribution on internet of songs protected by copyright<sup>162</sup>. According to the summary of the case made by Advocate general JÄÄSKINEN, the songs of Mr Pinckney, a singer-songwriter living in France, were

---

161 J. GINSBURG, "Where Does the Act of 'Making Available' Occur?"

162 Reference for a preliminary ruling from the Cour de cassation (France) lodged on 11 April 2012, Case C-170/12, Peter Pinckney v KDG Mediatech AG.

reproduced on CD's in Austria, without his consent, by an Austrian company called Mediatech. The CD's were commercialised on internet by British companies, whose websites are accessible in France. Mr Pinckney brought proceedings against the Austrian company in France. Mediatech challenged the competence of the French courts and the French Court of cassation referred the case to the Court of Justice to decide whether it had jurisdiction on the basis of art. 5.3 of the Brussels I Regulation.

The Court of Justice has not answered the prejudicial issue yet and it might never provide a response to the French Court of cassation, as the admissibility of the issue is contested.

In his non-binding opinion, the Advocate general has nevertheless provided interesting guidelines to interpret art. 5.3 of the Brussels I Regulation and define the place where the damage occurs after an infringement to the making available right<sup>163</sup>.

The Advocate general first reminded that the action can be brought in the Member State where the defendant has his domicile or in the Member State where the harmful event occurs. As to the place of the harmful event, the Advocate general reminded the existence of an option between the Member State where the event giving rise took place and the Member State(s) where the damage happened.

According to the Advocate general the event giving rise to the harm has to be found at the place where the act of upload is decided, namely the place of establishment of the counterfeiter. That criterion is similar to the one applied in *Wintersteiger*.

*"En ce qui concerne le lieu de l'évènement causal, qui confère compétence à la juridiction saisie pour l'ensemble du dommage subi, je considère qu'il convient d'adopter en matière de droits d'auteur la même approche que celle retenue par la Cour dans l'arrêt Wintersteiger, précité, dans le domaine du droit des marques, consistant à attribuer compétence aux juridictions du lieu d'établissement des contrefacteurs présumés en tant que lieu où l'offre en ligne des CD – pour l'acte de distribution – ou bien la mise en ligne des chansons («upload») – pour l'acte de communication – a été décidée."*

As to the place of the damage, the Advocate general proposed to localize it in the Member States targeted by the infringing act:

*"En l'occurrence, s'agissant d'une atteinte alléguée à certains droits exclusifs d'auteur par l'intermédiaire d'Internet, il me semble que l'approche de la localisation développée par la Cour au plan substantiel dans les arrêts susmentionnés pourrait également être suivie pour déterminer le lieu de matérialisation du dommage aux fins d'application de l'article 5, point 3, du règlement n° 44/2001. Cette analyse me paraît en effet confortée par la nature propre du préjudice résultant d'une atteinte aux droits de distribution et de communication au sens de la directive 2001/29. Celui-ci s'analysant en un manque à gagner au titre de la diffusion non autorisée des œuvres, il me semblerait approprié de privilégier un for qui serait désigné à l'issue d'une analyse de la direction de l'activité vers un public donné par le site Internet en question, approche qualifiée par la doctrine de « théorie de la focalisation ». Le for ainsi désigné ne disposerait que d'une compétence limitée aux dommages survenus sur le territoire intentionnellement ciblé par l'auteur présumé de la violation".*

The Advocate general thus rejected the criterion of accessibility used in *e-Date Advertising* to localize the place where the damage occurs. However, Mr. JÄÄSKINEN did not define the elements to be taken into account to find the public targeted by a website. It only referred to an existing judgment of the Court of Justice:

*"Pour la mise en œuvre d'un tel rattachement, la Cour pourrait s'inspirer des critères non limitatifs dégagés dans l'arrêt Pammer et Hotel Alpenhof, étant précisé que lesdits critères me semblent devoir être appliqués par les juridictions nationales avec une certaine souplesse, tenant compte, notamment, de la nature de l'activité en cause."*

---

163 Opinion of the Advocate general JÄÄSKINEN of 13 June 2013 in the case C-170/12, Peter Pinckney v KDG Mediatech AG.

In the case *Pammer*, the Court proposed a non-exhaustive list of criteria capable of constituting evidence of an exploitation, such as the international nature of the activity, the use of a language or a currency other than the language or currency generally used in the Member State in which the exploitant is established, the mention of telephone numbers with an international code, the use of a top-level domain name other than that of the Member State in which the exploitant is established, and the mention of an international clientele composed of customers domiciled in various Member States (*infra sub* Part II, C, 1)<sup>164165</sup>.

The way the national courts apply the principles laid down by the Court of justice to cases deriving from copyright infringement on internet differ from one state to the other, and may even vary in the same country<sup>166</sup>.

The main question the national courts have to solve is whether the mere accessibility of a website in the territory is a sufficient basis for finding jurisdiction on basis of article 5.3 of the *Brussels I* Regulation (place where the damage occurs) or whether a closer connection than mere accessibility is required.

In France, the *Cour de cassation* generally stresses the necessity of the existence of a close link between the harmful event and the French territory<sup>167</sup>:

*“(…) la seule accessibilité d’un site internet sur le territoire français n’est pas suffisante pour retenir la compétence des juridictions françaises, prises comme celles du lieu du dommage allégué et sans rechercher si les annonces litigieuses étaient destinées au public de France (…)”* (emphasis added)

However, analysing the question of the place where the damage occurs after the publication of protected works of a Chilean artist made available on a Chilean website, the Cour d’appel in Paris has rendered a controversial decision, considering that the accessibility of the website was sufficient to justify French jurisdiction<sup>168</sup>:

*“Considérant, s’agissant du grief de contrefaçon, que le site incriminé constitue, selon les propres écritures de la partie défenderesse, une source d’information sur les artistes chiliens depuis l’époque coloniale jusqu’à nos jours, qu’à ce titre, fut-il rédigé en langue espagnole et édité au Chili, il vise nécessairement tant le public des amateurs d’art ou des historiens d’art qui est, par essence, un public international, ouvert sur le monde et recherchant sa documentation au-delà des frontières, que quiconque étant intéressé soit par l’art pictural chilien en général soit par l’oeuvre de Hernan G. en particulier, sera amené peu important à cet égard sa nationalité ou son lieu de résidence, à consulter un site informatif hébergé au Chili ;*

*Que par voie de conséquence et dès lors qu’il est constant que ce site est accessible depuis la France, force est de relever que le public français pertinent se trouve à même de réceptionner les contenus argués de contrefaçon, circonstance qui justifie de l’existence d’un lien de rattachement suffisant, substantiel ou significatif entre les faits illicites et le dommage allégué sur le territoire français et qui commande de retenir la compétence du tribunal de grande instance de Paris pour connaître de la contrefaçon ;”*(emphasis added)

---

164 CJEU 7 December 2010, joined cases C-585/08 and C-144/09, Peter Pammer v Reederei Karl Schlüter GmbH & Co KG (C-585/08) and Hotel Alpenhof GesmbH v Oliver Heller (C-144/09) (Pammer/Alpenhof).

165 For a recent analysis : J-P MOINY, "Droit international et droit européen – L'intention "géodéterminée": un facteur de rattachement confirmé?", R.D.T.I., 2012, 211-215.

166 R. DI NOTO, "La compétence internationale des juridictions françaises et allemandes en matière de cyber-délits de concurrence déloyale et de contrefaçon", retrieved via <http://m2bde.u-paris10.fr/content/la-comp%C3%A9tence-internationale-des-juridictions-fran%C3%A7aises-et-allemandes-en-mati%C3%A8re-de-cyber-d>

167 Cass. bel. 29 March 2011, retrieved via [www.legalis.net](http://www.legalis.net)

168 Paris 9 September 2009, retrieved via [www.legalis.net](http://www.legalis.net)

That decision has been criticized because for infringement occurring on Internet, the French courts – and especially the Cour d'appel in Paris<sup>169</sup> – usually require a closer connection than the mere accessibility of the website on the French territory.

Belgian case-law seems divided on the question whether the mere accessibility of a website is sufficient to provide jurisdiction to the Belgian courts and it is difficult to elaborate a global theory over the application of article 5.3 of the Brussels I Regulation by the Belgian courts.

A few years ago, the Cour d'appel in Brussels considered that it was competent to hear a litigation resulting from the making available of a French film on a website because it was accessible in Belgium:

*"Attendu qu'en l'espèce, le film « La Veuve de Saint-Pierre » a été écrit, réalisé et produit en France ; qu'il n'est pas démontré par l'appelante que les copies de ce film destinées à la télévision, la vidéo ou les DVD sont réalisées en Belgique ; qu'il n'est pas démontré non plus que le site web est alimenté depuis le territoire belge ;*

*Qu'il n'est toutefois pas contesté que le film a été distribué en Belgique et que le site web peut être consulté en Belgique ; que ce film pourra être vu par les téléspectateurs belges s'il est programmé sur une chaîne de télévision captée en Belgique et se retrouvera vraisemblablement dans les vidéothèques belges lorsqu'il sera mis en location ;*

*Que les juridictions belges sont donc compétentes pour connaître des effets préjudiciables sur le territoire belge de la réalisation et de la production du film en France ainsi que pour connaître de tous les effets des communications de ce film au public qui ont lieu en Belgique.*"<sup>170</sup>

A few years later, the Tribunal de première instance in Liège dealing with a litigation opposing the French Tennis Federation and online gambling websites adopted an intermediate position based on the mere accessibility of the website in Belgium and the existence of a few other connecting factors such as the use of the English language, the possibility to use the services provided on the website in Belgium, the fact that the Belgian football league, amongst others, was targeted by the website, ...<sup>171</sup>.

However, in a similar litigation between football clubs and gambling companies, the Cour d'appel in Liège denied the competence of the Belgian courts. According to the Cour d'appel, the accessibility of the websites in Belgium and the possibility to make online bets from Belgium does not justify the existence of a sufficient link between the litigation and the Belgian territory in order to provide jurisdiction to the Belgian courts:

*"La seule circonstance, déterminante à leurs yeux, que les sites web litigieux sont accessibles au public belge est impuissante à rendre compte de l'existence d'un lien de rattachement particulièrement étroit entre la contestation et les juridictions belges de nature à justifier une attribution de compétence à ces dernières pour la simple et bonne raison que, s'agissant de sites web '.com', ceux-ci sont, dès le placement du matériel en ligne, instantanément et automatiquement accessibles dans tous les États membres de l'Union européenne, pour ne parler que de ce qui intéresse celle-ci.*

*Les internautes de chacun des autres États contractants peuvent, à l'instar des internautes belges, faire enregistrer leurs paris sur ces sites, en sorte qu'à suivre l'interprétation que les (demanderesse) veulent donner de l'article 5.3, les juridictions de tous les États membres se retrouveraient simultanément compétentes pour connaître des éventuels dommages causés sur*

---

169 R. DI NOTO, "La compétence internationale des juridictions françaises et allemandes en matière de cyber-délits de concurrence déloyale et de contrefaçon".

170 Brussels 4 May 2001, J.L.M.B. 2001, 1444-1450.

171 Civ. Liège (Prés) 28 April 2008, J.L.M.B. 1015-1023.

*le territoire de leur État, à côté des juridictions naturelles appelées à connaître de l'entière du préjudice allégué que sont les tribunaux du domicile des (défenderesses).*

*Le résultat aboutirait donc à consacrer une base de compétence paneuropéenne. Or, cette conséquence va clairement à l'encontre des objectifs poursuivis par le règlement et, avant lui, par la Convention de Bruxelles, dans la mesure où ces instruments cherchent impérativement à favoriser la reconnaissance et l'exécution des décisions judiciaires en dehors de l'État dans lequel elles ont été rendues, ce qui implique qu'il est indispensable d'éviter la multiplication des juridictions compétentes sous peine d'accentuer au contraire les risques d'inconciliabilité de ces décisions."*

The Cour d'appel noted that the gambling companies had no establishment in Belgium, did not use servers hosted in Belgium and had no ".be" domain name. The websites were available in different languages but not necessarily in French and in Dutch, They offered betting services on multiple football leagues and not exclusively the Belgian competition. They did not seem to have a marketing strategy focused on the Belgian public. Finally, the number of Belgian gamblers using these websites was not significant.

The case went to the Cour de cassation, which cancelled the judgment delivered by the Cour d'appel and settled the dispute in favour of the jurisdiction of the Belgian courts:

*"L'arrêt attaqué énonce que la seule circonstance « que les sites web litigieux sont accessibles au public belge est impuissante à rendre compte de l'existence d'un lien de rattachement particulièrement étroit entre la contestation et les juridictions belges de nature à justifier une attribution de compétence à ces dernières », qu'en réalité, « les données propres aux sites litigieux ne fondent pas l'existence d'un lien de rattachement particulièrement étroit entre la contestation et la Belgique. [...] Les sites de paris sont accessibles aux internautes belges qui peuvent y faire enregistrer leurs paris dans la même mesure qu'ils sont accessibles aux internautes des autres États membres puisqu'il s'agit de sites '.com' qui ont vocation à élargir leur marché à l'Europe entière. Le fait que ces sites n'ont pas exclu le territoire belge de leur portée ne témoigne d'aucune attention particulière au marché belge dès lors que tel est le cas pour la grande majorité des autres États. Par ailleurs, ils n'ont pas non plus créé d'extension '.be' propre à la Belgique. Ils sont disponibles en plusieurs langues sans que s'y retrouvent systématiquement les deux langues les plus usitées en Belgique ».*

*Il considère enfin qu'« il n'est pas discuté que le nombre de paris pris par le public belge est tout à fait marginal par rapport au nombre total de paris enregistrés par ces sites », que, si, dans l'affaire Shevill, seulement cinq exemplaires des 250.000 de la publication litigieuse avaient été diffusés dans la ville où siégeait le tribunal saisi, « il existait de toute façon [dans cette affaire] un lien de rattachement particulièrement étroit entre l'atteinte à la réputation dont se plaignait la requérante et les tribunaux saisis, quel que soit le nombre d'exemplaires diffusés dans le for, dès lors que la plaignante vivait à l'endroit et subissait donc principalement l'atteinte dénoncée là-bas » et que « les [défenderesses] sont fondées à conclure en effet que leurs relations commerciales avec la Belgique sont 'de minimis'».*

*Ni par ces énonciations et considérations ni par aucune autre, l'arrêt attaqué ne justifie légalement sa décision d'accueillir les déclinatoires de compétence internationale soulevés en application du règlement (CE) 44/2001".*

The ruling delivered by the Belgian Cour de cassation is based on the judgment *eDate Advertising* and considers the accessibility of the website as the condition to confer jurisdiction to the Belgian courts. That condition might nevertheless evolve as the Court of justice seems to have replaced the criterion of accessibility by an exploitation approach in *Wintersteiger* and *Football Dataco*, and might confirm it in *Pinckney*.

In the Netherlands, the existence of a closer link than the mere accessibility of the website is required to sue a counterfeiter before the Dutch courts. The courts apply the principles fixed by the Hoge Raad in the

judgment *Ladbroke's*<sup>172</sup> to determine whether counterfeiting elements published on a website have occurred in the Netherlands. In the case *The Pirate Bay*, the Tribunal of Amsterdam ruled that the offer coming from the website *The Pirate Bay* was specifically focused on the Dutch territory. The judges noticed *inter alia* that *The Pirate Bay* was used from the Netherlands or through a Dutch provider, that it was using Dutch as language, that there were advertisements focused on the Dutch public and that files contained contents in Dutch<sup>173</sup>. The Tribunal therefore considered it had jurisdiction to hear the case.

In the United Kingdom, the High Court of Justice treated the question of jurisdiction in the case *Football Dataco and Sportradar*, before it was referred to the Court of Justice. The Chancery Division of the High Court expressly analysed the location of the making available act coming from the re-utilization of the database by Sportradar on a conflict of laws point of view:

*"Re-utilization" raises a question of law. Where does "making available to the public all or a substantial part of the contents of a database by ... on-line ... transmission" occur? Does it occur where the server is situated? Or where the public are? Or in both locations?*

(...)

*The debate in relation to both these provisions is similar to that which occurred in relation to "broadcasting". That debate has now been resolved, so far as the European Union and satellite broadcasts are concerned, by the Directive on Satellite Broadcasting and Cable Re-transmission, Directive 93/83 EC, and by amendments made to section 6 of the Act by the Copyright and Related Rights Regulations 1996 (SI 1996/2967) for all wireless broadcasts. By those provisions the place where the act of broadcast occurs is where the signals are introduced under the control of the person making the broadcast into an uninterrupted chain of communication. This is known as the "emission theory". There is no corresponding definition for either of the restricted acts in issue here.*

*Does the emission theory apply in the case of infringement of database right by making available to the public by online transmission? Mr Mellor submitted that it did not. He submitted firstly that the emission theory made sense in the context of satellite broadcasting, principally because of the approximate coincidence between the footprint of the satellite and the sphere of regulatory influence over the broadcasters, i.e. the European Union. With online transmission the server could be positioned anywhere – and in particular in states which are not party to any international obligations. He was, however, unable to point to any case or travaux préparatoires which indicated this as the basis for the emission theory as it applies to broadcasting. Moreover it is significant that the UK has adopted the emission theory for all wireless broadcasts, not solely satellite broadcasting: see section 6(4) of the Act.*

(...)

*I have come to the conclusion that the better view is that the act of making available to the public by online transmission is committed and committed only where the transmission takes place. It is true that the placing of data on a server in one state can make the data available to the public of another state but that does not mean that the party who has made the data available has committed the act of making available by transmission in the State of reception. I consider that the better construction of the provisions is that the act only occurs in the state of transmission."<sup>174</sup> (emphasis added)*

The English judge considered that the making available act is committed where the transmission takes place and therefore provides jurisdiction to the courts in that country.

---

172 Hoge Raad (NL) 18 February 2005, NJ 2005, 404.

173 Rechtbank Amsterdam (Voorz.) 22 October 2009, AMI 2010, 18.

174 EWHC 2911 (Ch) (17 November 2010), retrieved via <http://www.bailii.org/ew/cases/EWHC/Ch/2010/2911.html>

That case then went to the Court of Appeal that addressed a prejudicial issue to the Court of justice of the European Union<sup>175</sup>. After the ruling delivered by the Court of justice, the Court of Appeal did not come back on the issue of jurisdiction and found it was competent to settle the dispute.

In Germany, the Landgericht München decided it was competent to hear a claim brought by a German right holder against an Austrian website unlawfully using maps protected by copyright. According to the Court, the website was accessible from Germany and it could potentially be used by its owner to enter into business relations with German customers, as it already was in the past<sup>176</sup>. Even if the argumentation used in that decision shows that the mere accessibility of the website is not sufficient to justify the jurisdiction of the German courts, no other decisive connecting factors were presented.

Furthermore, the Landgericht Köln ruled in another case that the accessibility of a website in Germany was not a sufficient condition to admit the jurisdiction of the German courts as the website had no impact on the German public. The Court especially focused on the absence of any German translation of the website, while it was translated in 8 other languages<sup>177</sup>.

According to the Italian expert we have consulted, in case of cross-border online infringement of copyright, Italian courts should apply the ordinary criteria of private international law and civil procedure law in order to find out where the copyright protected act takes place and where the supposed infringer can be sued (i.e., the place of domicile/residence of the defendant or the place where his or her servers are located, if the infringer does not have a domicile in Italy)<sup>178</sup>.

By applying these rules, in terms of jurisdiction cases of online copyright infringement should be brought before the court of the place where the illegal conduct has taken place and, if this is not possible, at the place where communication to the public has been technically enabled (i.e., place of the servers of the infringer). In this respect, the criterion of the place where the harmful event occurs can only play a subordinate role. As far as territorial competence of courts is concerned, moreover, it should be considered that the liability exemptions created to the benefit of providers of services of mere conduit, in their transposition into Italian law, should be understood as making it impossible for the court of the place where such provider is established to assert its competence, even though copyright has been infringed through its networks.

Finally, a recent judgment in the United States of America should be mentioned. So far, the mere accessibility of a website in a forum was not deemed sufficient for a court to exercise jurisdiction over the defendant. However, the New York Court of Appeals decided in the case *Penguin Group v. American Buddha* that it had jurisdiction to treat a claim brought by a New York copyright holder against the owner

---

175 EWCA Civ 330 (29 March 2011), retrieved via <http://www.bailii.org/ew/cases/EWCA/Civ/2011/330.html>

176 Landgericht München, Urteil vom 30.07.2009, Az. 7 O 13895/08, retrieved via <http://www.damm-legal.de/lg-muenchen-i-gerichtsstand-bei-rechtsverletzungen-im-internet-dort-wo-potentielle-kunden-sind>

177 Oberlandesgericht Köln, 30 October 2007, GRUR, 2008, 71

178 The reasoning of the Italian expert is based on the observation that several decisions in the Italian case law have examined the issue of where an unlawful act of online communication should be deemed to have occurred, for purposes of applicable law, jurisdiction and territorial competence of courts. Italian courts have drawn on principles of tort law, civil procedure, private international law, and constitutional law in order to take such resolutions and to determine where a tort committed online (e.g., defamation) had occurred. Outside the specific domain of copyright law, for instance, there is a relevant judgment of the United Chambers of the Italian Supreme Court (judgment n. 21661 of 13.10.2009) that held that the tort of defamation becomes punishable only when online transmission of unlawful content is complete and the conduct becomes perceivable by the offended party. In the same judgment the Supreme Court added that the fact that a tort occurs online should not unreasonably expand the opportunities for the claimant to file suit in any fora or courts because of the ubiquity of the Internet and of the perception of on-line offences and infringements in so many different places. The Italian Constitution (Art. 25), according to the Supreme Court, makes it mandatory for civil procedure law to render the territorial competence of courts foreseeable. This means that courts should localize torts avoiding the adoption of criteria (like the one localizing torts where its harmful consequences materialize) that would make infringements potentially ubiquitous and would end up giving the claimant the chance to sue the infringer whenever he or she wants.



of a website located in another State of the US, because the plaintiff's business interests were harmed in New York<sup>179</sup>:

*“the role of the Internet in cases alleging the uploading of copyrighted books distinguishes them from traditional commercial tort cases where courts have generally linked the injury to the place where sales or customers are lost. The location of the infringement in online cases is of little import inasmuch as the primary aim of the infringer is to make the works available to anyone with access to an Internet connection, including computer users in New York. In addition, the injury to a New York copyright holder, while difficult to quantify, is not as remote as a purely indirect financial loss due to the broad spectrum of rights accorded by copyright law. (...) Thus, we conclude that the alleged injury in this case occurred in New York for purposes of CPLR 302 (a) (3) (ii).*

*Finally, contrary to American Buddha's assertion, our decision today does not open a Pandora's box allowing any nondomiciliary accused of digital copyright infringement to be haled into a New York court when the plaintiff is a New York copyright owner of a printed literary work. Rather, CPLR 302 (a) (3) (ii) incorporates built-in safeguards against such exposure by requiring a plaintiff to show that the nondomiciliary both "expects or should reasonably expect the act to have consequences in the state" and, importantly, "derives substantial revenue from interstate or international commerce." There must also be proof that the out-of-state defendant has the requisite "minimum contacts" with the forum state and that the prospect of defending a suit here comports with "traditional notions of fair play and substantial justice," as required by the Federal Due Process Clause." (emphasis added)*

The reasoning of the American Court of Appeal is interesting, but it is difficult to find relevant elements for the present studies, as it refers to specific American concepts of fair play and due process clause. Jurisdiction ultimately failed because the defendant did not derive substantial revenue from interstate or international commerce. J. Ginsburg nevertheless notices that the European and American approaches are complementary rather than contradictory<sup>180</sup>.

#### **(iv) Intermediate conclusion**

Even if there are few judicial decisions relating to the making available right, we have found, in the absence of a clear definition, that its supposed cross-border character causes issues in terms of jurisdiction.

These issues generally arise in non-contractual disputes.

Currently the national courts of a European Member State have jurisdiction if alternatively the defendant is established in that Member State, or the event giving rise to the infringing act or the damage resulting from this event occur on their national territory:

- The courts of the Member State where the defendant is established have jurisdiction with regard to the entire damage.
- According to the decision *Wintersteiger*, the event giving rise to the infringement should be located at the place “*where the activation of the display process is decided*”, i.e. the place of establishment of the user. The courts in that Member State have jurisdiction to settle the entire damage suffered by the author.
- According to the Court of justice, the courts of the Member States where the damage occurs have jurisdiction with regard to the damage caused in that Member State. However, the place where the damage occurs depends on the interpretation provided by the national judges. In the absence of a clear definition, the courts generally examine whether the accessibility of a website in their country is a sufficient link to provide jurisdiction. The national case law of the Member

---

179 US Court of Appeals (2nd. Circ. NY), 12 May 2011, retrieved via <http://law.justia.com>

180 J.C. GINSBURG, “Where does the act of “making available” occur?.

States is divided on that point. Certain courts consider that the mere accessibility of a website is sufficient to justify jurisdiction, while others require closer connecting factors between the infringing acts and their territory and require the infringing act to target a public on their territory to provide jurisdiction to the judges of that Member State.

That approach is the one favoured by the Court of justice in *Football Dataco* with regard to the act of reutilisation of databases. It might be confirmed in *Pinckney* concerning the right of communication to the public. If this is so, the national courts will still have to define which elements they take into account to prove that the exploitation of the work targets their Member State.

- A new localisation of the place where the damage occurs was proposed by the Court of justice in *eDate Advertising* and in *Wintersteiger*, providing jurisdiction to the courts of one Member State (respectively the Member State where the victim has the centre of her interests and the Member State where the trade mark has been registered) with regard to the whole damage suffered. The application of a similar principle to the making available right is uncertain, as the connecting factors selected by the Court of justice may not be applied to copyright. Advocate general JÄÄSKINEN has rejected such an outcome in his opinion over the case *Pinckney*.

## b) Applicable law

In cross-border conflicts, once the issue of jurisdiction has been settled, then the judge often has to determine under which law the dispute has to be solved.

With regard to the applicable law, a distinction has to be made between the law applicable to the copyright itself and the law applicable to the exploitation of the work (whether it is a contractual or non-contractual exploitation). It may be difficult to delineate the limits between the scope of those two laws.

### (i) Authorship and ownership

Article 5.2 of the Berne Convention refers to the application of the laws of the country for which a protection is claimed (*lex loci protectionis*) to the enjoyment and the exercise of the rights provided under the Convention.

That provision is generally presented as a rule treating the conflicts of laws<sup>181</sup>. Authors are however divided on that question and some of them consider that this provision is a substantive rule establishing the scope of the Berne Convention<sup>182</sup>.

---

181 Article 5 provides:

(1) Authors shall enjoy, in respect of works for which they are protected under this Convention, in countries of the Union other than the country of origin, the rights which their respective laws do now or may hereafter grant to their nationals, as well as the rights specially granted by this Convention.

(2) The enjoyment and the exercise of these rights shall not be subject to any formality; such enjoyment and such exercise shall be independent of the existence of protection in the country of origin of the work. Consequently, apart from the provisions of this Convention, the extent of protection, as well as the means of redress afforded to the author to protect his rights, shall be governed exclusively by the laws of the country where protection is claimed.

(3) Protection in the country of origin is governed by domestic law. However, when the author is not a national of the country of origin of the work for which he is protected under this Convention, he shall enjoy in that country the same rights as national authors.

(4) The country of origin shall be considered to be:

(a) in the case of works first published in a country of the Union, that country; in the case of works published simultaneously in several countries of the Union which grant different terms of protection, the country whose legislation grants the shortest term of protection;

(b) in the case of works published simultaneously in a country outside the Union and in a country of the Union, the latter country;

(c) in the case of unpublished works or of works first published in a country outside the Union, without simultaneous publication in a country of the Union, the country of the Union of which the author is a national, provided that:

Furthermore, the extent of article 5.2 is uncertain<sup>183</sup> and it is argued that the *lex loci protectionis* does not apply to issues related to the determination of authorship/initial ownership, which would remain governed by the law of the country in which the right is granted (*lex loci originis*). The *lex loci originis* refers to the law of the country of origin in the sense of the Berne Convention, i.e. the country of the first publication of the work or, in case of unpublished works, the country of which the author is a national (article 5.4)<sup>184</sup>.

Even if the Court of Justice has now provided a uniform definition of the originality, that issue remains important because it is not limited to the European Union but affects all the contracting parties of the Berne Convention. Furthermore, that debate also applies to the determination of authorship, and that issue is not harmonised by the Court of Justice so far.

A part of the legal scholarship defends the position that the law of the *locus originis* of the work should apply to the determination of the initial ownership. This would vest the authorship or initial ownership in one person (natural or legal), regardless of the subsequent fate of the work. Such solution provides simplicity and consistency<sup>185</sup>.

Applying the *lex loci protectionis* by contrast would lead to different persons claiming copyright protection, depending on the place where that protection is sought. This could even result in the exclusion of the person who is considered as the author or initial owner in the *locus originis*. This variability affects the legal certainty not only from the initial rights holder's point of view, but also from the users' point of view, as "it could mean, for example, with respect to joint works, that different persons would be adjudged authors of the same work in different countries, depending on each country's standard for demonstrating authorship"<sup>186</sup>. For that reason, J. Ginsburg and S. Ricketson claim that "even if article 5(2) announces a choice of law rule, it does not purport to cover all issues of international copyright. Notably, questions of authorship, initial ownership, and transfers of ownership remain unaddressed"<sup>187</sup>. These authors consider that the Berne Convention sets forth neither substantive rules nor choice of law rules to determine copyright ownership and that each Member State is free to apply its choice of law rules to determine initial ownership:

*"It makes more sense to conceive of copyright as germinating in a work's source country, subsequently to flower in all other countries in which the work is protected. The countries that later host the work tend to its growth, but the welcome they extend to the work does not uproot it from its source. The work's source country (country of first publication, or residence, or domicile, or nationality of the author, or, where relevant, the country where the immovable work is located) thus should determine who is the initial titleholder. (...)*

*That choice of law rule ensures that the work will not change initial owners by operation of law each time the work crosses an international boundary.(...)*

(i) when these are cinematographic works the maker of which has his headquarters or his habitual residence in a country of the Union, the country of origin shall be that country, and

ii) when these are works of architecture erected in a country of the Union or other artistic works incorporated in a building or other structure located in a country of the Union, the country of origin shall be that country.

182 Interpreting art. 5.2 as a material rule: M. VAN EECHOUDET, Choice of law in copyright and related rights: Alternatives to the *lex loci protectionis*, 2003, 95.

In favour of the interpretation of art. 5.2 as a rule on conflicts of laws: N. BOUCHE, Le principe de territorialité de la propriété intellectuelle, Editions L'Harmattan, 2002, 508.

183 On that question, A. LUCAS, Applicable law in copyright infringement cases in the digital environment, 2-4 ; A. CRUQUENAIRE, "La loi applicable au droit d'auteur : état de la question et perspectives", 8-10.

184 The meaning of the "country of origin" rule in the sense of the Berne Convention differs from the "country of origin" principle applied at the European level in several directive, which we will analyse in the second part of the present Study.

185 A. STROWEL and J.-P. TRIAILLE, Le droit d'auteur, du logiciel au multimedia, Kluwer, 1997, 378.

186 S. RICKETSON and J. GINSBURG, International copyright and neighbouring rights, vol I, 376.

187 S. RICKETSON and J. GINSBURG, International copyright and neighbouring rights, vol II, 1299.

*Resort to the law of the source country reinforces the security of international contracts, and therefore would seem to promote the international exchange of copyrighted works.*<sup>188</sup>

M. Van Eechoud rejects the application of the *lex loci protectionis* as the law governing the initial ownership and the transfers of rights as well and she prefers the *lex loci originis*:

*“Domestic laws do, however, tend to deal differently with the allocation of rights in case of works made for hire and works created by two or more co-contributors (e.g. film). If one were to let the lex protectionis govern issues of initial ownership, the result would be legal uncertainty as to who qualifies as initial right owner. (...) The tendency in case-law and among scholars to use some form of the lex originis for initial ownership, is mainly inspired by the wish to avoid this legal uncertainty.*

*In my opinion, the move away from the lex protectionis towards a single governing law is a development to be welcomed, as it could increase legal certainty and thereby facilitate the cross-border exploitation of works.*<sup>189</sup>

However, she admits that the precise definition of a localisation criterion is difficult<sup>190</sup>.

An important part of the legal doctrine defends the opposite view and considers that the *lex loci protectionis* should apply to all issues relating to copyright, including the determination of authorship<sup>191</sup>, or at least to the determination of the initial ownership on a work<sup>192</sup>, according to article 5.2 of the Berne Convention. A. Lucas considers that the country of origin in the Berne Convention should only apply in exceptional cases and not as a matter of principle to determine the existence and/or the ownership of the right<sup>193</sup>. According to him such extensive application would contradict article 5.2 BC and art. 14bis.2.a. BC, in relation to audiovisual works<sup>194</sup>. Lucas does not consider it appropriate to dissociate “preliminary” copyright questions (such as authorship) from the “content” of the right<sup>195</sup>. The *lex loci protectionis* should consequently govern all aspects of a copyright matter:

*“As long as the copyright laws continue to differ substantially, the application of one choice of law rule to all aspects of the right in question seems the best solution in order to get coherent results, as these aspects are interdependent in the respective copyright acts, and a cumulative application could lead to inconsistent results. (...)*

*The Country of protection principle, applied to all aspects of copyright, having the advantage of being – according to the predominant position – consistent with Berne standards, seems to be the most convenient to establish. It also has the highest support among the EU Member States.*<sup>196</sup>

According to that principle, the author of a copyright does not own one single copyright with international validity, but a bundle of many national copyrights<sup>197</sup>.

188 S. RICKETSON and J. GINSBURG, *International copyright and neighbouring rights*, vol II, 1320-1321.

189 M. VAN EECHOU, *Choice of law in copyright and related rights*, Kluwer, 2003, 179.

190 M. VAN EECHOU, *Choice of law in copyright and related rights*, 126-127.

191 A. LUCAS, H.-J. LUCAS and A. LUCAS-SCHLOETTER, *Traité de la propriété littéraire et artistique*, LexisNexis, Paris, 2012, 1237-1241; F. DE VISSCHER and B. MICHAUX, *Précis du droit d’auteur et des droits voisins*, 2000, Bruylant, Brussels, 638; A. CRUQUENAIRE, “La loi applicable au droit d’auteur : état de la question et perspectives”, 5.

192 F. DE VISSCHER and B. MICHAUX, *Précis du droit d’auteur*, 638.

193 A. LUCAS, “Applicable law in copyright infringement cases in the digital environment”, 4-6.

194 This provision states : “Ownership of copyright in a cinematographic work shall be a matter for legislation in the country where protection is claimed.”

195 A. LUCAS, “Applicable law in copyright infringement cases in the digital environment”, 4-6.

196 X., *Final report to the study on intellectual property and the conflict of laws*, April 2000, Part III, 24, [http://ec.europa.eu/internal\\_market/copyright/docs/studies/etd1999b53000e16\\_en.pdf](http://ec.europa.eu/internal_market/copyright/docs/studies/etd1999b53000e16_en.pdf)

Lucas nevertheless admits that the application of the *lex loci protectionis* has to be softened by the “*droits acquis*” theory<sup>198</sup>. This *droits acquis* theory implies that the rights acquired by a person under the aegis of one law subsequently have to be recognized in other countries<sup>199</sup>. Indeed, it is common for authors to entrust the exploitation of their works to a publisher, record label, film producer, collecting society,... The user should then conclude a contract for the exploitation of the work with the person actually holding the rights. F. De Visscher and B. Michaux confirm that the questions of ownership after a contractual transfer of rights should be assessed by the general rules applicable to conflicts of laws in the sphere of contracts<sup>200</sup>. Consequently, if a contractual transfer of the rights on a work has occurred, the uploader or the service provider wanting to make that work available should acquire the rights in conformity with the contractual arrangements of the author or initial right owner.

From a judicial point of view, it seems that the choice between the *lex loci protectionis* and the *lex loci originis* differs from one Member State to the other: Belgium relies at least partly on the *lex loci originis*<sup>201</sup>, while other countries, for instance Germany, apply the *lex loci protectionis* for the issues of initial ownership. In Denmark, the issue is unsettled in the literature and has not resulted in reported case law. The case of the Eastern Court of Appeal reported in Ugeskrift for Retsvæsen 1997.975 Ø presupposes that *lex loci protectionis* is applicable to rules on ownership (but the issue was not disputed in the case). In Poland, the law of the country where the right is exploited is used in respect of the creation, the content and the cessation of copyright, so that it covers the issues of initial ownership.

The French Cour de cassation has recently settled the debate in favour of the application of the *lex loci protectionis* to the issues of authorship. The Cour de cassation had to deal with a litigation between a cameraman established in France and an American broadcasting company having him working under an employment contract during several years. After the cameraman was fired by the American broadcaster, he claimed that the company was infringing his rights on his works. The Cour d’appel in Paris considered that the *lex loci originis* – in this case American law – had to apply to settle the debate concerning the authorship on the works, so that the American broadcaster, as an employer, was the holder of the rights.

The Cour de cassation rejected that reasoning and explained that art. 5.2. of the Berne Convention that refers to the *lex loci protectionis* applies to the issues of authorship<sup>202</sup>.

These issues have never been examined in the context of litigation or scholarly discussions in Italy. Italian provisions on conflict of laws are embodied into an act (Law N. 218/1995) where issues such as authorship, initial ownership and transfers of rights are not taken into special consideration. The understanding of such issues from a cross-border perspective depends largely on the interpretation of general rules that Italian law creates for wider categories of norms, acts or fact. For instance, the fact that the moral rights of the author under Italian law are legally treated as personality rights could trigger the application of the provision indicating that the existence and subject matter of a personality right should be regulated by the national law of each person (see Art. 24 of Law 218/1995). As far as economic prerogatives of the author are concerned, Italian law provides that intellectual property rights are governed by the law of the state of utilization of the protected works, which is a consequence of the strict principle of territoriality of intellectual property law (in the same way as the principle according to which, in case of violation of an IP right, the applicable law should be that of the country where protection is sought). As regards the transfer of rights, Italian law “nationalized” the 1980 Rome convention on contractual obligations and, as a result, Italian authors transferring their rights are free (in theory) to opt for the application of a foreign law to such agreements. However, these agreements would not have the

---

197 Final report to the study on intellectual property and the conflict of laws Part. II, 12,.

198 A. LUCAS e.a., *Traité de la propriété littéraire et artistique*, 1241.

199 M. VAN EECHOU, *Choice of law in copyright and related rights*, 99.

200 F. DE VISSCHER and B. MICHAUX, *Précis du droit d’auteur et des droits voisins*, 638.

201 M. PERTEGAS, “Artikel 93 – recht toepasselijk op intellectuele eigendom”, in J. ERAUW et al., *Het wetboek internationaal privaatrecht becommentarieerd*, Brussels, Bruylant, 2006, p. 479.

202 Cass. (fr.) 10 april 2013, <http://www.legifrance.gouv.fr/>

power to validly impose clauses conflicting with public order provisions granting non-waivable rights to the author.

**(ii) Exploitation of the copyright**

After having defined which law applies to the issue of authorship/initial ownership, we will successively examine the principles and legal provisions determining the law applicable to copyright contracts and to non-contractual copyright infringements.

**- Law applicable to copyright contracts**

There is no worldwide instrument for determining the law applicable to disputes related to copyright contracts<sup>203</sup>.

At the European level, the Member states of the European Union have adopted the Regulation (EC) No 593/2008 of the European Parliament and of the Council of 17 June 2008 on the law applicable to contractual obligations (*Rome I*)<sup>204</sup>. That regulation applies in all the Member states, except in Denmark, “*in situations involving a conflict of laws, to contractual obligations in civil and commercial matters*”. It determines the law applicable to the interpretation of the contract, its performance, the consequences of a breach of contractual obligations, the ways of extinguishing obligations and prescription and limitations of actions, and the consequences of the nullity of a contract (art. 12).

Copyright contracts fall under the scope of that Regulation, especially under articles 3, 4 and 6. We will also examine articles 8 and 9 of the Regulation.

According to article 3, and subject to what will be explained below regarding consumers, the parties have the freedom to select the law applicable to their contract. The courts will have to respect that choice if it complies with the principles laid down in article 3.

Article 4 of the *Rome I* Regulation then defines which law is applicable in the absence of a choice made by the parties. Paragraph 1 defines which law is applicable to different sorts of contracts (sale of goods, provision of services, distribution, ...). However, copyright contracts do not really fit one of these categories. According to the decision in *Falco*, a contract under which the owner of an intellectual property right grants its contractual partner the right to use the right in return for remuneration may not be interpreted as a contract for the provision of services.

According to paragraph 2 of the Article 4, where the contract is not covered by paragraph 1, it shall be governed by the law of the country where the party required to effect the characteristic performance of the contract has his habitual residence.

Finally, paragraphs 3 and 4 especially stress on the criterion of proximity and require the application of the law of the country with which the contract is the most closely connected<sup>205</sup>.

---

203 F. DE VISSCHER and B. MICHAUX make a distinction between the content of the contract and the context of the contract. They consider that the *lex loci protectionis* (see below) does not apply to the issues related to the content of the contract (*Précis du droit d'auteur et des droits voisins*, 633, 641-651). A. LUCAS adds that “the operator still has to allow for the various domestic laws applicable to the right, in respect of all matters that are not governed by the law of the contract” (“Applicable law in copyright infringement cases in the digital environment”, 8).

204 Regulation (EC) No 593/2008 of the European Parliament and of the Council of 17 June 2008 on the law applicable to contractual obligations (*Rome I*), OJ L 177, 4 July 2008, 6–16.

205 Article 4 provides:

1. To the extent that the law applicable to the contract has not been chosen in accordance with Article 3 and without prejudice to Articles 5 to 8, the law governing the contract shall be determined as follows:

As a consequence, article 4 requires the identification of connecting factors between the contract and the law applicable. Prof. P. GOLDSTEIN and B. HUGENHOLTZ note that *“in situations where a copyright transfer is an integral part of any of the contract types mentioned in article 4(1), the transfer will most likely be governed by the corresponding rule. In other cases, the analysis will require identification of “the party required to effect the characteristic performance”<sup>206</sup>. Prof. A. LUCAS adds that “the predominant doctrine holds that characteristic performance must be presumed to be effected by the assignee or licensee who undertakes a contractual obligation to perform and by the rightholder in the absence of such an obligation”<sup>207</sup>.*

This implies that the law applicable to a contract according to which the licensee would undertake to exploit protected works and make them available on internet would be the law of the country of the licensee.

In the case of complex copyright contracts, the law of the country with which the contract is the most closely connected would apply, in accordance with article 4(3) and 4(4)<sup>208</sup>.

Complementary to articles 3 and 4, article 6 of the *Rome I* Regulation contains a specific provision that applies to contracts concluded by consumers with professionals. These contracts are governed by the law of the country where the consumer has her habitual residence. The aim of such provision is to protect consumers from abusive clauses which would allow the application of the professional’s law system<sup>209</sup>.

Such provision could for instance apply to contracts concluded by private users who download protected works made available on the internet.

The Regulation *Rome I* contains a specific provision determining the law applicable to the individual employment contracts. According to article 8(1), these contracts are governed by the law chosen by the parties, provided that this choice may not deprive the employee of the protection afforded to him by

---

(a) a contract for the sale of goods shall be governed by the law of the country where the seller has his habitual residence;

(b) a contract for the provision of services shall be governed by the law of the country where the service provider has his habitual residence;

(...)

2. Where the contract is not covered by paragraph 1 or where the elements of the contract would be covered by more than one of points (a) to (h) of paragraph 1, the contract shall be governed by the law of the country where the party required to effect the characteristic performance of the contract has his habitual residence.

3. Where it is clear from all the circumstances of the case that the contract is manifestly more closely connected with a country other than that indicated in paragraphs 1 or 2, the law of that other country shall apply.

4. Where the law applicable cannot be determined pursuant to paragraphs 1 or 2, the contract shall be governed by the law of the country with which it is most closely connected.

206 P. GOLDSTEIN and B. HUGENOLTZ, *International Copyright*, 144-145.

207 A. LUCAS, “Applicable law in copyright infringement cases in the digital environment”, 7.

208 P. GOLDSTEIN and B. HUGENOLTZ, *International Copyright*, 145.

209 Article 6 provides:

1. Without prejudice to Articles 5 and 7, a contract concluded by a natural person for a purpose which can be regarded as being outside his trade or profession (the consumer) with another person acting in the exercise of his trade or profession (the professional) shall be governed by the law of the country where the consumer has his habitual residence, provided that the professional:

(a) pursues his commercial or professional activities in the country where the consumer has his habitual residence, or

(b) by any means, directs such activities to that country or to several countries including that country, and the contract falls within the scope of such activities.

2. Notwithstanding paragraph 1, the parties may choose the law applicable to a contract which fulfils the requirements of paragraph 1, in accordance with Article 3. Such a choice may not, however, have the result of depriving the consumer of the protection afforded to him by provisions that cannot be derogated from by agreement by virtue of the law which, in the absence of choice, would have been applicable on the basis of paragraph 1.

3. If the requirements in points (a) or (b) of paragraph 1 are not fulfilled, the law applicable to a contract between a consumer and a professional shall be determined pursuant to Articles 3 and 4.

provisions that cannot be derogated from by agreement under the law that, in the absence of choice, would have been applicable to the contract.

Paragraphs 2, 3 and 4 provide additional rules to find the law applicable to the contracts when the parties have not specified it.

Article 9 of the Regulation *Rome I* protects overriding mandatory provisions. In order to protect certain principles the respect for which is regarded as crucial by a country for safeguarding its public interests, article 9 foresees the application of the overriding mandatory provisions of the law of the forum, regardless the law applicable to the rest of the contract.

Moreover, article 21 preserves the application of the rules of public policy of the forum. The judge may indeed refuse to apply a foreign law when his rules of public policy require him to substitute the parties' private choice by his own copyright law. As a consequence, the copyright law of the forum supersedes private contract terms<sup>210</sup>.

Such hypothesis may occur to guarantee the protection of moral rights for instance<sup>211</sup>. In the *Huston*<sup>212</sup> judgment, the French *Cour de cassation* decided to apply French law instead of American law to guarantee the protection of the moral rights of the right holders, despite the existence of a valid contract under American law and according to which the author had globally transferred his rights to an American producer.

There is no decision of the Court of justice of the European Union yet with regard to the enforcement of those provisions to copyright contracts.

- **Law applicable to non-contractual copyright infringement**

The law applicable in non-contractual disputes in the field of copyright refers to the *lex loci protectionis* according to which the judge has to apply the law of the country for which a protection is claimed. As we mentioned above, that rule is fixed in article 5(2) of the Berne Convention.

The Regulation (EC) No 864/2007 of the European Parliament and the Council of 11 July 2007 on the law applicable to non-contractual obligations (*Rome II*) also refers to the application of the *lex loci protectionis*<sup>213</sup>. Like *Brussels I*, that Regulation applies in all the Member states of the European Union, except in Denmark. Article 4 of the Regulation *Rome II* first provides a rule that generally applies to the conflicts of laws, "unless otherwise provided for in the Regulation". It clearly opts for the law of the country where the damage occurs, and rejects the law of the country of the event giving rise to the infringing act.

Then, article 8 contains a specific rule for conflicts of laws in the field of IP rights that refers to the abovementioned *lex loci protectionis*<sup>214</sup>. Article 26 of the Regulation expressly entitles the judges to refuse

210 P. GOLDSTEIN and B. HUGENOLTZ, *International Copyright*, 140.

211 A. CRUQUENAIRE, "La loi applicable au droit d'auteur : état de la question et perspectives", 19-21

212 Cass. (fr.), 28 May 1991, retrievable via <http://www.legifrance.gouv.fr/>

213 Regulation (EC) No 864/2007 of the European Parliament and of the Council of 11 July 2007 on the law applicable to non-contractual obligations (Rome II) OJ L 199, 31.7.2007, p. 40–49.

214 Article 8 provides:

1. The law applicable to a non-contractual obligation arising from an infringement of an intellectual property right shall be the law of the country for which protection is claimed.
2. In the case of a non-contractual obligation arising from an infringement of a unitary Community intellectual property right, the law applicable shall, for any question that is not governed by the relevant Community instrument, be the law of the country in which the act of infringement was committed.
3. The law applicable under this Article may not be derogated from by an agreement pursuant to Article 14.



the application of a specific provision that would be manifestly incompatible with their rules of public policy.

According to article 15 of the Regulation *Rome II*, the *lex loci protectionis* governs the basis and the extent of liability, the grounds for exemption from liability, any limitation of liability and any division of liability, the existence, the nature and the assessment of damage or the remedy claimed, and the measures which a court may take to prevent or terminate injury or damage or to ensure the provision of compensation. In case of proceedings, a distinction has to be made between the law applicable to the procedural rules (which should be treated under the *lex fori*) and the law applicable on the substance (for which the *lex loci protectionis* will apply). Meanwhile, the limits of the scope of both laws may be uncertain, as it is sometimes very difficult (in the case of provisional measures for instance) to define where the issues of procedural law stop and where the debate related to the substance begin.

Furthermore, there is a potential conflict between article 15 of the Regulation *Rome II* and article 31 of the Regulation *Brussels I: Rome II* extends the application of the *lex loci protectionis* to provisional or protective measures *within the limits of powers conferred on the court by its procedural law*, while *Brussels I* states that *application may be made to the courts of a Member State for provisional, including protective, measures as may be available under the law of that State, even if the courts of another Member State have jurisdiction as to the substance of the matter*<sup>215</sup>.

Since plaintiffs often seek protection in the country where the harm is transpiring, localizing the place of the harm generally identifies both a forum, and the applicable law in that forum:

*“The court of the country whose market the person making a work available has allegedly targeted will determine whether the defendant has in fact sought customers from that jurisdiction. If so, that country will be a place in which the making available occurs, and the forum will be competent not only to hear the case, but to apply its own law to the making available of the work to users within the jurisdiction.”*<sup>216</sup>

Nevertheless, as previously explained about jurisdiction, in case of complex infringements, it may be difficult to find the location of the infringing act (initiating in one country and culminating in another) and, consequently, to determine for which country the protection is sought. The *lex loci protectionis* may indeed refer to the application of multiple laws, as the act is generally interpreted as taking place in different countries, *i.e.* the country of the event giving rise to the infringement (Member State from which the work is made available – *country of transmission*) and the countries where the damage occur (Member States to which the work is made available – *countries of reception*)<sup>217</sup>.

The law of the country of the event giving rise to the harm (country of transmission) should regulate the full territorial impact of the act of making available, while the law of a country where the damage occurs (country of reception) only has effect in that country exclusively and not in the other countries also targeted by the uploader:

*“Because the defendant’s targeting of Member State B’s market justifies B’s competence, it would follow that if the defendant is targeting multiple markets, then the act of making available occurs in each national market to which the defendant directed its communications, and that each national market is competent to hear and to regulate disputes arising out of the making available of works to its residents. It would also follow that Member State B has no authority to adjudicate or regulate makings available that occur in Member States C, D, or E (etc.). In order to adjudicate the full*

---

215 A. SUSSAROVA, “La portée du principe ‘forum regit processum’ dans la pratique judiciaire belge”, R.D.C., 2012, 157-159.

216 J. GINSBURG, “News From the EU: Where Does the Act of ‘Making Available’ Occur?”.

217 J. GINSBURG, “Where does the act of “making available” occur?”.

*territorial impact of the makings available, the right owner may need to sue in Member State A, where the defendant (and its server?) resides.*<sup>218</sup>

Both the country of transmission and the country of reception present advantages, but also important disadvantages with regard to the applicable law:

- The application of the law of the country of transmission would give the opportunity to counterfeiters to search and locate their activities in a country with a low protection of copyright. This could lead to a bad protection of the right holders:

*“It would be absurd in the field of authors’ rights to favour the application of the first option in cases of complex torts committed through the Internet because the result would too often be contrary (existence of digital havens) to the objective sought by the Berne Convention, which is precisely to promote effective international protection of literary and artistic works.”*<sup>219</sup>

*“The issue actually at stake is the risk of delocalization to countries of transmission with a lower level of protection, a very real risk given the significant differences between national laws, particularly in regard to exceptions to the exclusive rights, and the great ease with which the uploading site can be manipulated in digital networks.”*<sup>220</sup>

*“la thèse du (des) pays de réception nous semble plus appropriée que celle du pays d’émission, d’une part parce qu’il est difficilement contestable que la diffusion via Internet correspond à une exploitation dans chacun des pays de réception et, d’autre part, en raison des difficultés techniques de localisation du point d’émission d’une transmission numérique.”*<sup>221</sup>

- The application of the law of the country of reception is a difficult option with the use of internet, as the damage may potentially be worldwide. It would indeed force the persons uploading protected works to take into consideration the potential consequences of their acts with regards to many different legal systems and lead, in case of infringement, to the application of the law of each country affected by the infringement:

*“When the content is made available over the internet, lex loci protectionis allows the right holder to pursue the infringement under the law of each country where the work has been uploaded or could be potentially accessed (in most cases, worldwide). This enables right holders who have sufficient resources to identify and claim the most protective law in the case. Although formally the relief acquired under one country’s law should be limited to its territory, in practice it often has extraterritorial effects. Meanwhile the user (both an ISP and a private consumer) who makes the works available online faces a threat to be sued under any law where the work can be accessed and thus should accommodate its conduct to (almost) each law worldwide. This causes great legal uncertainty and hampers the development of legitimate online businesses.”*<sup>222</sup>

*“Those who argue in favour of the law of the country of transmission highlight the legal security of the distributor, maintaining that the distributor may not be bound to respect practically all the laws in the world, which would be the case if the differing laws of the countries of reception were applied.”*<sup>223</sup>

---

218 J. GINSBURG, “News From the EU: Where Does the Act of ‘Making Available’ Occur?”.

219 P. SIRINELLI, “Chronique de jurisprudence: Exploitation internationale des œuvres de l’esprit”, RIDA 2010, 306-308.

220 A. LUCAS, Applicable law in copyright infringement cases in the digital environment, 11.

221 A. CRUQUENAIRE, “La loi applicable au droit d’auteur : état de la question et perspectives”, 23.

222 R. MATULIONYTÉ, “The Law Applicable to Online Copyright Infringements in the ALI and CLIP Proposals: A Rebalance of Interests Needed?”, Jipitec, 2011/2, 4.

223 A. LUCAS, Applicable law in copyright infringement cases in the digital environment, 12.

*“emission theory’ cannot be considered reflective of online activity and its application potentially renders the rights of UK citizens, in an online context, completely meaningless.”<sup>224</sup>*

*“Cette solution présente toutefois d’importants problèmes pratiques du point de vue des exploitants d’œuvres protégées parce qu’elle leur impose la prise en compte d’un nombre considérable de législations, ce qui peut indiscutablement constituer un frein à l’exploitation des œuvres sur Internet.”<sup>225</sup>*

As the principles “country of transmission” and “country of reception” are contested, intermediate solutions are sometimes proposed, such as the application of the law of the place where the responsible for the use of the protected works is located, the law of the place where the servers are located or the law of the countries where the final users reside. Nevertheless, these intermediate solutions seem unsatisfactory to us mainly for two reasons. First of all, it is difficult to establish with certainty the location of persons or servers in relation to an Internet use. Secondly, the aim of these intermediate solutions is only to protect one group of persons (the users, the authors,...) and it does not take into account the interests of the other groups.

A last option consists in combining both the principles “country of transmission” and “country of reception”:

*“General principles of private international law thus lead us to distinguish judicial and legislative competence. While we can accept, and indeed propose, that the forum of plaintiff’s residence have jurisdiction over the full territorial extent of a violation of the making available right, the same result should not determine the applicable law. Neither the law of the country of origin of the infringement, nor that of the impact of the harm (when the harm from multiple territories is centralized at the copyright owner’s residence) should govern the totality of multi-territorial infringements. Rather, the judge should apply the law of each country whose market is disrupted by the impact of the infringement.”<sup>226</sup>*

National courts also hesitate with regard to the different options proposed by the *lex loci protectionis*. It is important to note, once again, that few decisions have been delivered at that level:

*“As far as Internet infringements are concerned, the courts often do not discuss any private international law issues at all; they, at most, confine themselves to briefly referring to jurisdictional questions and simply apply forum law.”<sup>227</sup>*

Recently, the *Google* cases raised conflict of laws issues in France and in Belgium, as Google tried to obtain the application of the American copyright law and its exception of *fair use* in Europe.

In France, the judges have analysed the connecting factors in order to apply the law of the country which had the most significant relationship with the dispute.

In the case *Google/La Martinière*, the Court of Grande Instance in Paris declared that French law was applicable, after having noted the existence of many connecting factors between the dispute and the French territory<sup>228</sup>:

*« Or attendu que la loi applicable à la responsabilité extra contractuelle en matière de délit complexe est celle de l’Etat du lieu où le fait dommageable s’est produit ; que ce lieu s’entend*

224 C. O'REILLY, "Finding jurisdiction to regulate Google and the Internet", E.J.L.T. 2011/2, 2.

225 A. CRUQUENAIRE, "La loi applicable au droit d'auteur : état de la question et perspectives", 16.

226 J. GINSBURG, "Where does the act of "making available" occur?".

227 R. MATULIONYTÉ, "The Law Applicable to Online Copyright Infringements in the ALI and CLIP Proposals", 218.

228 TGI Paris, 18 December 2009, retrieved via [www.legalis.net](http://www.legalis.net)

aussi bien de celui du fait générateur du dommage que de celui du lieu de réalisation de ce dernier ;

qu'en l'espèce, il n'est pas contesté que le litige concerne des œuvres d'auteurs français numérisées pour être accessibles par extraits aux internautes français sur le territoire national ; que par ailleurs il convient de relever, outre le fait que le tribunal saisi est le tribunal français, que les sociétés demanderesse sont établies en France pour la société Editions du Seuil ou filiales d'une société française pour les deux autres, que de même les intervenants volontaires habilités à défendre les intérêts des auteurs et des éditeurs français sont de nationalité française, que la société Google France a son siège en France, que le nom de domaine permettant l'accès au site [www.books.google.fr](http://www.books.google.fr) a une extension ".fr" et que ce site est rédigé en langue française ;

qu'il résulte de l'ensemble de ces éléments que la France est le pays qui entretient les liens les plus étroits avec le litige, ce qui justifie l'application de la loi française contrairement à ce que soutiennent les défenderesses ; » (emphasis added)

The same reasoning can be found in the case *Google/SAIF*, in which it is important to notice that the *Cour d'appel* in Paris has decided to apply French law although the *Tribunal de grande instance* had first ruled in favour of Google and applied American law<sup>229</sup>:

« Qu'il ne peut être retenu que le rattachement au territoire français serait insuffisant au seul motif que les faits reprochés trouvent pour l'essentiel leur origine hors de France, étant observé qu'il n'est pas réellement contesté que la loi du lieu du dommage est susceptible de s'appliquer en cas de proximité manifestement plus étroite avec le litige ;

Qu'à cet égard si les services incriminés peuvent être consultés par un public francophone il n'en demeure pas moins que le litige qui porte sur le fonctionnement de Google images concerne des services en français accessibles au public français et est principalement destiné à ce public en ce qu'il est en particulier accessible par des adresses URL en ".fr" ( [google.fr](http://google.fr) et [images.google.fr](http://images.google.fr) ) ; que le territoire français s'avère incontestablement délibérément visé comme le pays où les images peuvent être visualisées et choisi en toute connaissance de cause ;

Que le lieu de connexion et de réception voulu par le titulaire du moteur de recherche constitue un critère de proximité substantiel alors que les services mis en place tendent à produire leurs effets en France et que leur objet tel que revendiqué par les intimées est de faciliter l'accès des Internaute à l'information et à la connaissance ;

Qu'il est ainsi suffisamment établi que le pays de réception constitue un lien de proximité manifestement plus pertinent que celui de faits générateurs pour apprécier le présent litige ; que la décision critiquée sera en conséquence infirmée en ce qu'elle a fait application en la cause du Copyright Act de 1976 et non de la législation française ». (emphasis added)

J. GINSBURG notices that, even if the Regulation Rome II did not apply to these cases, the assessment made by the courts in Paris is consistent with its provisions<sup>230</sup>.

Furthermore, these decisions are in line with the case law of the French *Cour de cassation*, which applies alternatively the law of the country where the event giving rise to the infringing act took place<sup>231</sup> and the law of the country where the damage occurred<sup>232</sup>.

229 Paris, 26 January 2011, retrieved via [www.juriscom.net](http://www.juriscom.net)

230 J.C. GINSBURG, "Conflict of Laws in the Google Book Search: A View From Abroad", The Media Institute, 2 June 2010, [http://www.mediainstitute.org/IPI/2010/060210\\_ConflictOfLaws.php](http://www.mediainstitute.org/IPI/2010/060210_ConflictOfLaws.php)

231 Cass. 5 March 2002, Bull., 2002, I, n° 75, 58; Cass. 30 January 2007, Bull., 2007, I, n° 44, 37.

232 Cass. 14 January 1997, Bull., 1997, I, n° 14, 8; Cass. 27 March 2007, Bull., 2007, I, n° 132.

Therefore, in France, making a work available on the internet without the author's prior consent is an infringing act that will be treated either under French law, or under a foreign law, depending on the connecting factors that will be identified between the dispute and the country whose law will be applied.

The French Cour de cassation seems to approve that reasoning. In a dispute between Google and a photographer whose photographs were made available on Google Images, it confirmed the application of French law based on the existence of a close link between the French territory and the exploitation of the photographs made by Google:

*“Attendu que les sociétés Google reprochent à l'arrêt de déclarer la loi française applicable au litige, alors, selon le moyen :*

*1°/ qu'en application de l'article 5 § 2 de la Convention de Berne pour la protection des oeuvres littéraires et artistiques, la loi applicable aux agissements litigieux est celle du pays où la protection est réclamée qui n'est pas celle du lieu où le dommage est subi mais celle du pays sur le territoire duquel se sont produits les agissements ; qu'en l'espèce, statuant sur la contestation relative à la loi applicable au litige, la cour d'appel a dit la loi française applicable en retenant que le litige porte sur le fonctionnement des services Google Images, rédigés en français, destinés au public français et accessibles en France par les adresses URL en ". fr ", que l'internaute pourra ainsi visualiser en France la photographie de M. X... et au besoin la télécharger, que cette photo a été mise en ligne et stockée sur plusieurs sites français, que la société Aufeminin. com, dont la responsabilité est également recherchée, est une société dont le siège est à Paris, qu'il suit que le lieu de destination et de réception des services Google Images et de connexion à ceux-ci, caractérisent un lien de rattachement substantiel avec la France qui commande l'application de la loi française ; qu'en se prononçant ainsi, lorsque la loi applicable au litige devait être déterminée par application de la Convention de Berne pour la protection des oeuvres littéraires et artistiques du 9 septembre 1886, la cour d'appel a violé l'article 5 § 2 de ladite Convention ;*

*2°/ qu'en application de l'article 5 § 2 de la Convention de Berne pour la protection des oeuvres littéraires et artistiques, la loi applicable aux agissements litigieux est celle du pays où la protection est réclamée qui n'est pas celle du lieu où le dommage est subi mais celle du pays sur le territoire duquel se sont produits les agissements ; qu'en retenant, pour décider que la loi française était applicable, que le fonctionnement des services Google Images, rédigés en français, destinés au public français et accessibles en France par les adresses URL en ". fr ", que l'internaute pourra ainsi visualiser en France la photographie de M. X... et au besoin la télécharger, que le lieu de destination et de réception des services Google Images et de connexion à ceux-ci caractérisaient un lien de rattachement substantiel avec la France, la cour d'appel a violé l'article 3 du code civil ensemble l'article 5 § 2 de la Convention de Berne ;*

*3°/ qu'en application de l'article 5 § 2 de la Convention de Berne pour la protection des oeuvres littéraires et artistiques, la loi applicable aux agissements litigieux est celle du pays où la protection est réclamée ; qu'en retenant, pour justifier l'application de la loi française, que la société Aufeminin. com, dont la responsabilité est également recherchée, est une société dont le siège est à Paris quand le lieu du siège social du codéfendeur n'a aucune incidence sur la loi applicable aux actes litigieux, la cour d'appel a statué par des motifs inopérants et violé les articles 3 du code civil et 5 § 2 de la Convention de Berne ;*

*Mais attendu que l'arrêt retient que le litige porte sur le fonctionnement des services Google Images, en des textes rédigés en français, destinés au public français et accessibles sur le territoire national par les adresses URL en ". fr " et que le lieu de destination et de réception des services Google Images et de connexion à ceux-ci caractérisent un lien de rattachement substantiel avec la France ; qu'il en déduit exactement, conformément à l'article 5. 2 de la Convention de Berne qui postule l'application de la loi de l'Etat où la protection est réclamée, que l'action introduite par M. X..., qui réclamait, en tant qu'auteur de la photographie, la protection de ses droits en France à la suite de la constatation en France de la diffusion en France, par un hébergeur français, la société Aufeminin. com, d'une photographie contrefaisante, mise en ligne pour le public français sur le site de Google Images par le service des sociétés Google Inc. et*

*Google France, relevait de la loi française ; que le moyen n'est fondé en aucune de ses branches,*<sup>233</sup>

In Belgium, the Court of Appeal in Brussels also decided to apply Belgian law to copyright infringements by Google<sup>234</sup>. That decision based on a close analysis of articles 5.2 and 5.3 of the Berne Convention deals with the rights of reproduction and communication to the public. It does not consider the making available right itself<sup>235</sup>:

*“Aux termes de l'article 5 (4) (a) de la Convention, le pays d'origine des œuvres en cause est la Belgique puisque les articles de presse ont été publiés pour la première fois en Belgique.*

*La Convention n'entend pas s'appliquer dans le pays d'origine de l'œuvre sauf au cas où l'auteur n'est pas ressortissant de ce pays, un élément d'extranéité apparaissant alors, faute duquel les auteurs de la convention ne voulaient pas intervenir dans le pays d'origine (F. DE VISSCHER et B. MICHAUX, Précis du droit d'auteur, Bruylant, 2000, p. 609).*

*Il s'en déduit que, conformément à l'article 5 (3) de la Convention, la protection en Belgique est régie par la loi belge. »*

The Belgian judges have thus rejected the conflict of laws rule contained in article 5.2 and they have applied article 5.3 of the Berne Convention as they considered that the dispute was raised in the country of origin of the works.

Interpreting the *Rome II* Regulation, the judges have subsidiarily answered the question of the location of an online publication on Internet:

*“Enfin, à supposer que la Convention de Berne ne contiendrait pas de références suffisamment claires pour résoudre le conflit de loi dans le cadre d'une situation complexe où le lieu de la faute et du dommage seraient situés dans deux pays différents, il s'imposerait à la cour d'appliquer sa loi nationale.*

*Dans ce cas, il faut se référer à la règle générale contenue à l'article 4.1 du Règlement (CE) n° 864/2007 du Parlement Européen et du Conseil du 11 juillet 2007 sur la loi applicable aux obligations non contractuelles ("Rome II") (...)*

*Il ne convient en effet pas d'avoir égard à l'article 8 traitant des atteintes aux droits de propriété intellectuelle ni à l'article 93 du Code de droit international privé puisque ces dispositions reprennent les mêmes termes que ceux de la Convention de Berne, à savoir « la législation du pays où [interprété par « pour lequel »] la protection est réclamée ».*

*A supposer que les actes préparatoires à la contrefaçon, à savoir l'injection des données dans les serveurs de Google, doivent entrer en ligne de compte pour la détermination du lieu du fait dommageable, il conviendrait alors de constater que le délit est formé par un ensemble de faits complexes situés dans des pays différents (les Etats-Unis pour l'injection et la Belgique pour la diffusion) et qu'il y a lieu de se référer à la loi du pays avec lesquels le fait dommageable présente des liens manifestement plus étroits (cf. article 4 (3) du Règlement 864/2007). Ainsi que cela a été dit plus haut, il s'agit de la Belgique, pays vers lequel les œuvres protégées sont diffusées sur le site Google.be.*

233 Cass (fr.), 12 July 2012, n° M 11-15.188 and n° M 11-15.165, <http://www.legifrance.gouv.fr/>

234 Brussels, 5 May 2011, retrievable via [www.juridat.be](http://www.juridat.be).

235 The relation between the Berne Convention and the making available right is presented above (n° 32).

*Privilégier la loi de l'injection peut conduire à décerner un brevet d'impunité au contrefacteur puisqu'il lui suffirait de localiser ses serveurs dans des pays à faible protection en matière de droits d'auteur, ce qui est manifestement contraire au but recherché par la Convention de Berne.*

*Certes, une page diffusée sur un site ayant un nom de domaine se terminant par «.be » peut être lue dans le monde entier. Elle n'est cependant susceptible que d'intéresser des belges résidant à l'étranger ou des étrangers souhaitant être informés de ce qui se passe en Belgique. Leur nombre est dérisoire par rapport à tous les internautes résidant en Belgique. Cette seule circonstance ne suffit pas pour soutenir, comme le fait Google, que « les points de contact avec la Belgique sont manifestement insuffisants ».*

The Court's decision could be criticized on that point as it applies the general rule for conflict of laws provided by article 4 of the *Rome II* Regulation, instead of the specific rule for IP rights issues contained in article 8. The explanation provided for that choice, namely the fact that the rule mentioned in article 8 is the same than the one in article 5 of the Berne Convention (the "*lex loci protectionis*"), is difficult to understand. Indeed, even if it is the same rule, there is no reason why it should not apply to a dispute in the field of copyright. In any case, similarly to the French courts, the judges in Brussels finally relied on the "connecting factors" criterion to solve the conflict of laws issue.

As regards the applicable law, Italian private international law<sup>236</sup> provides that the law of the country where the protected intangible work has been used should regulate the enforcement of intellectual property rights. This rule should be made compatible with Art 8 of Regulation EC 864/07.

The infringing act has to happen in Germany for the German law to be applicable. If the exploitation completely happens abroad, the German law cannot apply<sup>237</sup>.

In Poland, private international law and IP law issues have been recently referred to in the Act on International Private Law of 4 February 2011<sup>238</sup>. Art. 33 refers to Regulation Rome II. Moreover, according to art. 5 of the Polish Copyright Act, Polish law applies to works whose author or co-author is a Polish citizen, or a citizen of one of the countries of the European Union or EFTA, or to works first published in Poland or simultaneously in Poland and abroad, first published in Polish and works protected on the basis of international agreements.

In Canada, the Supreme Court referred to the "connecting factor" criterion. It has defined a number of elements that can be decisive in function of the circumstances to determine which law applies:

*"The applicability of our Copyright Act to communications that have international participants will depend on whether there is a sufficient connection between this country and the communication in question for Canada to apply its law consistent with the "principles of order and fairness . . . that ensure security of [cross-border] transactions with justice"; see Morguard Investments, supra, at p. 1097; see also Unifund Assurance Co. v. Insurance Corp. of British Columbia, [2003] 2 S.C.R. 63, 2003 SCC 40, at para. 56; Sullivan and Driedger on the Construction of Statutes (4th ed. 2002), at pp. 601-2.*

(...)

*So also, in my view, a telecommunication from a foreign state to Canada, or a telecommunication from Canada to a foreign state, "is both here and there". Receipt may be no less "significant" a connecting factor than the point of origin (not to mention the physical location of the host server, which may be in a third country).*

---

236 See Italian act of 31 May 1995, N. 218, Art. 54.

237 Cf the case that led to the Le Corbusier ECJ decision, BGH 8 December 2010 GRUR 2011 227.

238 Dz. U. Nr 80, poz. 432

(...)

*A real and substantial connection to Canada is sufficient to support the application of our Copyright Act to international Internet transmissions in a way that will accord with international comity and be consistent with the objectives of order and fairness.*

*In terms of the Internet, relevant connecting factors would include the situs of the content provider, the host server, the intermediaries and the end user. The weight to be given to any particular factor will vary with the circumstances and the nature of the dispute.*

(...)

*Generally speaking, this Court has recognized, as a sufficient “connection” for taking jurisdiction, situations where Canada is the country of transmission (Libman, supra) or the country of reception (Liberty Net, supra). This jurisdictional posture is consistent with international copyright practice.*

The Supreme Court of Canada expressly relied on the making available right and declared that this right was generally exercised at the point of transmission:

*“Canada is a signatory but not yet a party to the WIPO Copyright Treaty. This treaty responded to the development of the Internet and other on-demand telecommunications technology. Article 8 provides that:*

*. . . authors of literary and artistic works shall enjoy the exclusive right of authorizing any communication to the public of their works, by wire or wireless means, including the making available to the public of their works in such a way that members of the public may access these works from a place and at a time individually chosen by them.*

*The “making available” right is generally exercised at the point of transmission. This does not deny the interest of the country of reception but avoids, as a matter of policy, a “layering” of royalty obligations in different countries that are parties to the WIPO Copyright Treaty.*<sup>239</sup>

That part of the decision seems contradictory to the principles applied by the European Courts, which seem to consider that the country of reception is the decisive place to resolve the conflict of laws.

### ***(iii) Intermediate conclusion***

As for jurisdiction, the unclear extent of the making available right causes applicable law issues.

First of all, a distinction has to be made between the law applicable to the copyright and the law applicable to the exploitation of copyright. The borders between these two subjects may be difficult to find.

- As to the law applicable to the copyright itself, there is a controversy between the application of the *lex loci protectionis* and the application of the *lex loci originis*. The way the courts answer that controversy differs from one country to the other.
- Regarding the law applicable to the exploitation of copyright, we have observed that the absence of definition of the protected act makes it impossible to determine its location and leaves the door open for various interpretations of the *lex loci protectionis* (country of transmission and countries of reception). The law applicable to the making available right actually depends on the way national judges interpret that act and on the connecting factors they find between the protected act and the country for which the protection is sought. If they opt for the law of the country of transmission, one legislation will be applicable for the same pan-

---

239 Canadian Supreme Court, *Society of Composers, Authors and Music Publishers of Canada v. Canadian Assn. of Internet Providers*, 2004 SCC 45 ; [2004] 2 S.C.R. 427 (June 30, 2004), retrievable via <http://scc.lexum.org>.



European infringement. On the contrary, if they opt for the law of the country of reception, multiple laws should be applied to repair a pan-European damage resulting from one single infringement.

The French case *Google v SAIF* clearly demonstrates that the present situation is a source of legal uncertainty for right holders and for users of the works, to whom it is difficult to predict which law will govern the act of making works available on Internet.

In the absence of a harmonized definition of the making available right, the Principles on Conflict of Laws in Intellectual Property prepared by the European Max Planck Group on Conflict of Laws in Intellectual Property could provide objective elements to help the national courts ruling on conflict of laws issues<sup>240</sup>. According to article 3:603, the courts may apply the law of the country that has the closest connection with the infringement. That article then indicates the relevant factors that the judge has to take into account to find that connection<sup>241</sup>.

### c) General conclusion regarding private international law issues

Because of its worldwide scope, the use of Internet generally reveals various questions of private international law. In the field of copyright, the national courts propose different interpretations of the existing rules. This causes legal uncertainty for the right holders as well as for the users of protected works, especially in case of infringements:

- As to the jurisdiction, the courts of different Member States are cumulatively competent, namely:
  - The courts of the Member State where the defendant is domiciled (for the whole damage);
  - The courts of the Member State where the event giving rise to the infringement took place (for the whole damage);
  - The courts of the Member States where the damage occurred (for the part of the damage that occurred in each Member State respectively), taking into account the fact that there is a debate whether a damage occurs at the place where a website is accessible, even if the website does not target a public at that place;

The Court of justice has recently proposed to provide jurisdiction to the courts of the Member State where the victim has the centre of her interests (for personality rights) or where the

---

240 Principles on Conflict of Laws in Intellectual Property prepared by the European Max Planck Group on Conflict of Laws in Intellectual Property, retrieved via <http://www.cl-ip.eu/files/pdf2/FinalText-1December2011.pdf>.

241 Article 3:603 provides:

(1) In disputes concerned with infringement carried out through ubiquitous media such as the Internet, the court may apply the law of the State having the closest connection with the infringement if the infringement arguably takes place in every State in which the signals can be received. This rule also applies to existence, duration, limitations and scope to the extent that these questions arise as incidental questions in infringement proceedings.

(2) In determining which State has the closest connection with the infringement, the court shall take all the relevant factors into account, in particular the following:

(a) the infringer's habitual residence;

(b) the infringer's principal place of business;

(c) the place where substantial activities in furtherance of the infringement in its entirety have been carried out;

(d) the place where the harm caused by the infringement is substantial in relation to the infringement in its entirety.

(3) Notwithstanding the law applicable pursuant to paragraphs 1 and 2, any party may prove that the rules applying in a State or States covered by the dispute differ from the law applicable to the dispute in aspects which are essential for the decision. The court shall apply the different national laws unless this leads to inconsistent results, in which case the differences shall be taken into account in fashioning the remedy.

trade mark has been registered (for trade marks). Even if these are places where the damage occurs, the courts in these Member States have jurisdiction with regard to the reparation of the whole damage. Following the opinion expressed by the Advocate general Jääskinen in *Pinckney*, we do not think that a new interpretation of article 5.3 of the Regulation *Brussels I* might apply in the field of copyright.

- As to the applicable law, the courts will have to make a choice based on different elements:
  - If the dispute relates to the determination of authorship/initial ownership, then the choice has to be made between the application of the law of the country of origin of the work (*lex loci originis*) or the law of the country for which the protection is sought (*lex loci protectionis*).
 

If they opt for the *lex loci protectionis*, they might have to choose between the law of the country of the event giving rise to the infringement (country of transmission) and the laws of the countries where the damage occurs (countries of reception).
  - If the dispute relates to the exploitation of the copyright, then the law applicable is:
    - The law of the contract in case of a contractual exploitation;
    - The law of the country for which the protection of copyright is sought (*lex loci protectionis*) in case of a non-contractual exploitation: because the use of internet implies cross-border exploitations, the *lex loci protectionis* may refer to the law of the country of transmission or to the laws of the countries of reception.
  - The national courts usually apply the law of the country with which the dispute is the most closely connected.

The criteria used to define which Member States have jurisdiction and which law is applicable are factual criteria, independent from the analysis of the case on the substance. Nevertheless, the way the copyright acts are defined on the substance and localised may have an impact on the way the judge will solve the questions of private international law.

While centralizing the litigation in a single Member State promotes efficient adjudication of Internet infringement claims, it does not always follow that a single law should apply to a multi-territorial infringement<sup>242</sup>.

We have concluded above that three definitions were available to describe the protected act:

- According to the first one, the act of making available covers the initial act of making the work accessible to the users/members of the public, the actual transmission of the work (if any) and the reception of the work.
- According to the second definition, the act of making available covers the initial act of making the work accessible to the users/members of the public, but not the actual transmission or reception of the work.
- According to the third proposal, only the material act of making a work available online is restricted under the making available right. The accessibility is considered only to determine whether a “public” has access (a work that can only be consulted by an individual user or by a group of users that do not constitute a “public” is then not made available to the public). The transmission and the reception are not protected under the making available right.

---

242 J. GINSBURG, “Where does the act of “making available” occur?”.

The choice of the third definition would have a direct impact on the private international law issues, as it would render easier the determination of the place where the protected act takes place. Various countries would still have jurisdiction to hear a claim related to the making available right, as the damage resulting from an infringement might be suffered all over the world. However, we assume that the law applicable to the dispute would be easier to determine, because the place where the obligation has to be performed (contractual matters) as well as the place where protection is claimed (non-contractual matters) would be easier to determine: it would correspond to the country of transmission.

The two other proposed definitions would not settle the private international law issues, as it would define the making available act as a complex one with cross-borders elements. The choice of a connecting rule would therefore be required in order to treat the problems of private international law. Such a choice is a complex one, as it could have an influence on the issue of a dispute between authors and users of the works. Recently, the CLIP Principles proposed to apply the law of the country that has the closest connection with the infringing act and provided criteria to find that connection. However, that rule leaves space for interpretation by the national judges.

## 2. Authorship, ownership and transfer of rights

According to the Information Society Directive, the making available right is an exclusive right (art. 3(1)(2)), which entitles its owner to authorise or prohibit the restricted acts under this right. Broadly speaking, this entails, on the one hand the right holder's consent should be cleared before making the work available and, on the other hand, that she has the right to enforce it in case of infringement.

Since the making available right may contain several constitutive elements that may take place on the territories of several Member States, divergent national rules on authorship and ownership may raise complications, in particular for the clearing of rights and for their enforcement.

In this section it will be examined for the Member States under consideration how the national copyright legislation regulates issues of authorship and ownership. Questions of conflict of laws are not dealt with in this section but *sub* 1.

Authorship, initial ownership and the transfer of rights are regulated at the national level. Little has been harmonised at the international<sup>243</sup> and European levels<sup>244</sup>. This leads to considerable disparities.

The conditions applicable to contracts relating to intellectual property in the European Union have been described in a report of 2002 by the University of Amsterdam, commissioned by the European Commission<sup>245</sup>. The report first assessed the legislative provisions dealing with the initial allocation of ownership of rights in the European Union, before examining the issues of transfer of rights. The current Study will take the results of the 2002 IViR study as its starting point.

The rules on authorship and the ones determining the ownership after a transfer of the rights will be examined together. These topics are indeed closely related since the author (creator) of a work may be the initial owner of copyright in some Member States, while other Member States may indicate another natural or legal person as the initial owner of copyright of the same work by virtue a legal rule operating a transfer of rights. The holder of the rights on a work may thus differ from one Member State to the other.

---

243 The Berne Convention also leaves the determination of authorship, ownership and transfer of rights to national legislations.

244 The issue of who benefits from copyright and the one of the transfer of rights are among the least harmonised at the European level.

245 L. GUIBAULT and B. HUGENHOLTZ, Study on the conditions applicable to contracts relating to intellectual property in the European Union, 2002, retrieved via [http://ec.europa.eu/internal\\_market/copyright/docs/studies/etd2000b53001e69\\_en.pdf](http://ec.europa.eu/internal_market/copyright/docs/studies/etd2000b53001e69_en.pdf), hereafter the 2002 IViR report.

### a) National authorship rules

The notion of authorship is not globally harmonised at the European level. In some directives, the authorship for certain types of works is determined: for audiovisual works<sup>246</sup>, for computer programs<sup>247</sup> and for databases<sup>248</sup>. In relation to other kinds of works, the Member States remain free to determine who the author is.

The Berne Convention does not contain an explicit authorship rule but it is assumed that the author is the person to whom the intellectual and creative effort can be attributed<sup>249</sup>. Such principle is known as the “creator doctrine”. Accordingly, the authorship of a work is vested in the natural person who has *created* the work, rather than in the person or company that has invested in its production.

The creator doctrine complies with the definition of originality provided by the Court of Justice, where it states that a work is original if it reflects the “*author’s own intellectual creation*”<sup>250</sup>. The Court adds that “*an intellectual creation is an author’s own if it reflects the author’s personality. That is the case if the author was able to express his creative abilities in the production of the work by making free and creative choices*”<sup>251</sup>.

#### (i) Application of the creator doctrine

Assessing the rules applicable to the determination of authorship, the 2002 IViR report found two major tendencies in the European countries: “*On the one hand are the Anglo-Saxon countries, like Great Britain and Ireland, where copyright protection is said to follow utilitarian objectives. There, the initial ownership of rights may be conferred, depending on the circumstances, either on the natural person who created the work or on the legal person who invested in its production, like an employer or a film producer. On the other hand are most countries of continental Europe, where copyright protection is*

246 Art. 2.2 of Directive 2006/115/EC of 12 December 2006 on rental right and lending right and on certain rights related to copyright in the field of intellectual property: “The principal director of a cinematographic or audiovisual work shall be considered as its author or one of its authors. Member States may provide for others to be considered as its co-authors”.

Article 2.1 of Directive 2006/116/EC of 12 December 2006 on the term of protection of copyright and certain related rights: “The principal director of a cinematographic or audiovisual work shall be considered as its author or one of its authors. Member States shall be free to designate other co-authors”.

Article 1.5 of Council Directive 93/83/EEC of 27 September 1993 on the coordination of certain rules concerning copyright and rights related to copyright applicable to satellite broadcasting and cable retransmission: “For the purposes of this Directive, the principal director of a cinematographic or audiovisual work shall be considered as its author or one of its authors. Member States may provide for others to be considered as its co-authors”.

247 Art. 2.1 of Directive 2009/24/EC of 23 April 2009 on the legal protection of computer programs: “1. The author of a computer program shall be the natural person or group of natural persons who has created the program or, where the legislation of the Member State permits, the legal person designated as the rightholder by that legislation.

Where collective works are recognised by the legislation of a Member State, the person considered by the legislation of the Member State to have created the work shall be deemed to be its author.

2. In respect of a computer program created by a group of natural persons jointly, the exclusive rights shall be owned jointly.

3. Where a computer program is created by an employee in the execution of his duties or following the instructions given by his employer, the employer exclusively shall be entitled to exercise all economic rights in the program so created, unless otherwise provided by contract.”

248 Article 4.1. of Directive 96/9/EC of 11 March 1996 on the legal protection of databases: “1. The author of a database shall be the natural person or group of natural persons who created the base or, where the legislation of the Member States so permits, the legal person designated as the rightholder by that legislation.

2. Where collective works are recognized by the legislation of a Member State, the economic rights shall be owned by the person holding the copyright.

3. In respect of a database created by a group of natural persons jointly, the exclusive rights shall be owned jointly.”

249 M. VAN EECKHOUD e.a., *Harmonizing European copyright law*, Kluwer, 2009, 48.

250 Infopaq I, par. 37.

251 CJEU 1 December 2011, Case C-145/10, *Eva-Maria Painer v Standard VerlagsGmbH and Others*, par. 88-89.

based on *natural rights principles*. In these countries, only the natural person who created the work can be considered the author, on whom the initial ownership of the copyright is generally conferred following a principle known as the '*creator doctrine*.'<sup>252</sup> (our emphasis).

All the European copyright acts refer to the creator doctrine for the determination of the authorship of a work. However, the way the Member States apply the creator doctrine differs from one country to the other.

In Germany<sup>253</sup>, in Denmark<sup>254</sup>, in Hungary<sup>255</sup> and in Belgium<sup>256</sup>, the copyright act expressly refers to the creator doctrine. It is stated that the *author* is the *creator* of the work. In those countries, a transfer of the rights by contract is needed for a legal person to become the owner of the rights on a work.

France applies the creator doctrine as well and, except as explained hereafter, a legal person cannot be the author of a work. This is expressly stated in the French copyright act with regard to the works of joint authorship, the audiovisual works and the radio works<sup>257</sup> and the scholarly literature interpret the wording "author" especially art. L. 111-1 CPI and art. L. 113-1 CPI as referring only to natural person (annex)<sup>258</sup>. However, in France, like in Spain<sup>259</sup>, in Italy<sup>260</sup> or in Poland<sup>261</sup>, the copyright legislation explicitly allows a natural or a legal person other than the natural person who created the work to be the *initial owner* of the rights in specific circumstances strictly defined by law.

In the Netherlands, the copyright act does not specifically define the notion of authorship. The creator doctrine is the general rule. However an exception to the creator doctrine can be found in art. 8, according to which a public entity which communicates a work to the public as its own, without naming any natural person as the author thereof, shall be regarded as the author of that work. Furthermore, it is stated that the person who has designed and is supervising the creation of a work is deemed the author of that work (art. 6 Dutch Copyright Act), although this provision seems to have a narrow application in practice. Its scope is limited to works that are intellectually conceived, planned, created, and arranged by one person and executed – more or less technically – by one or more assistants<sup>262</sup>.

Finally, in the United Kingdom<sup>263</sup>, the copyright acts provide as a general rule that the person – whether a legal or a natural person – who has assumed the risks involved in the creation of the work is the initial owner of the rights.

The creator doctrine is thus applied in all the Member States – at least partially – to determine the authorship of a work. A few Member States apply that principle strictly and rarely allow other persons than the natural person who has intellectually created the work to be the initial owner of copyright. In those countries, a contract is needed to transfer the rights from the author to other persons who will exploit the work. Other legal systems contain provisions that limit the scope of the creator doctrine and provide that

---

252 Painer, 24.

253 Art. 7-8 German copyright act (Urheberrechtsgesetz).

254 Art. 1 Danish copyright act.

255 Art. 4.1 Hungarian copyright act.

256 Art. 6 Belgian copyright act.

257 Art. L.113-2; L. 113-7; L. 113-8 French copyright act.

258 Cass. (fr), 17 mars 1982, JCP G, 1983, II, 20054.

259 Art. 1, 5 Spanish copyright act.

260 Art. 6, 11 Italian copyright act.

261 Art. 12 Polish copyright act.

262 L. GUIBAULT and B. HUGENHOLTZ, Study on the conditions applicable to contracts relating to intellectual property in the European Union, 47.

263 Art. 9 British copyright act.

the initial owner of copyright may be the person who has taken the initiative of the work and therefore deserves to have full control over its exploitation.

Furthermore, the creator doctrine itself may lead to different outcomes, since its concrete application is a matter of practice and may vary according to subjective elements. .

### ***(ii) Special case: collective works***

Collective works are works created by several authors at the initiative of a natural or legal person. The legislations of several Member States contain specific provisions governing the ownership of rights on collective works.

In France for instance, one of the rare exceptions to the creator doctrine comes from the provisions regulating collective works. For these works, various criteria may apply to find the initial right holder, it can be the legal person who has taken the initiative of the collective work<sup>264</sup>, or his coordination or harmonization role, the disclosure by that person..... In Spain, the creator doctrine does not apply to collective works: the person – possibly a legal person – who discloses the collective work under her name is the initial owner of copyright<sup>265</sup>. In Italy, it is stated that the author of a collective work is the person who organizes and directs the creation<sup>266</sup>. In Hungary, the copyright act allows a legal person to be the initial right holder of copyright in the case of collective works<sup>267</sup>. GYERTYÁNFY, however, notes that there is no court decision on this issue yet, and he argues for the elimination of art. 6 from the statute<sup>268</sup>. In Poland, it is provided that the producer of a collective work enjoys the economic rights<sup>269</sup>.

Other Member States, such as Belgium, do not have specific rules applying to collective works. In these Member States, the exploitation of the collective works is done through the application of the general rules applying to joint authorship and the transfer of rights. In Denmark for example, it is specified that if a work has two or more authors, without the individual contributions being separable as independent works, the copyright in the work shall be held jointly.

In short, in the countries that have a specific regime for collective works, the initial owner of the economic rights on that work is the person who has taken the initiative of the collective work. That specific regime does not apply in all the countries of the European Union and, in some countries, a contract operating a transfer of rights is needed to allow the person who takes the initiative of the collective work to exploit it.

## **b) National rules on transfer of rights / ownership**

When the author is the initial owner of the rights on a work, any person who wants to use or exploit it (e.g. a producer) must acquire the rights and operate a transfer of rights. It happens either through allocation by law (a) or by way of contract (b).

### ***(i) Allocation by law and initial ownership***

In the present chapter, we will analyze two examples of disparities related to the legal provisions operating the transfer of the rights. We have focused our analysis on the issues of the transfer of the rights on works created under employment (i) and on audiovisual works (ii).

---

264 Art. L. 113-5 French copyright act.

265 Art. 8 Spanish copyright act.

266 Art. 7.1 Italian copyright act.

267 Art. 6 Hungarian copyright act.

268 GYERTYÁNFY: *ibid.* at 62., 65.

269 Art. 11 Polish copyright act.

- **Works created under the duties of an employment contract**

The initial ownership on works created under the duties of an employment contract is not harmonised at the European level, except for computer programs<sup>270</sup> and databases<sup>271</sup>. Most of the Member States have a specific regime that applies to works created by employees under the duties of their employment contract. The purpose of such provisions is to facilitate the transfer of rights from the employee to the employer, who remunerates the author and bears the economic risk.

In some countries, the employer is the initial owner of copyright on works created by her employees:

- The British copyright act expressly stipulates that the employer is the first owner of the rights on the works created by her employees<sup>272</sup>.
- Moreover, the Dutch copyright act provides that the employer has to be deemed the “maker” of the works created by her employees, unless otherwise decided by the parties<sup>273</sup>.
- In Poland, the employer will in principle be the initial owner of the rights on a work created by an employee under her duties resulting from the employment contract<sup>274</sup>.
- In Hungary, unless otherwise agreed, the employer acquires the economic rights on the works delivered by her employees, if the works were created in execution of the employee’s duties<sup>275</sup>.

In other countries, the employee remains the initial owner of the rights, but specific provisions of the copyright law facilitate the transfer of these rights to the employer:

- In Belgium, there may be a transfer of rights from the employees to the employer, if the assignment of rights is explicitly laid down in a written contract and if the creation falls within the scope of the employee’s contract<sup>276</sup>. Some of the rigorous rules on author contracts are not applicable to these agreements.
- In Spain, the existence of an employment contract does not operate *per se* a transfer of rights on works created by the employees. There must be a written clause operating the transfer of rights. In the absence of a written contract, the employer is nevertheless presumed to be the owner of the rights needed for the exercise of his usual activities<sup>277</sup>.
- The Italian copyright act does not provide any general rule that applies to the works created by employees. Art. 12ter organizes a transfer of the economic rights in favour of the employer for works of industrial design, in the absence of any stipulation to the contrary, if the works are created in the execution of the employee’s duties and following the instructions given by the employer<sup>278</sup>.

The French copyright act expressly excludes that existence or the conclusion of a contract for hire or of service by the author of the work have a consequence on the initial ownership of the rights<sup>279</sup>. As a consequence, in France, the conclusion of an employment contract does not imply that the employer automatically is the holder of the rights to the works created by his employees, neither can the employer

---

270 Art. 2.1 of Directive 2009/24/EC of 23 April 2009 on the legal protection of computer programs.

271 Article 4.1. of Directive 96/9/EC of 11 March 1996 on the legal protection of databases.

272 Art. 11 British copyright act.

273 Art. 7 Dutch copyright act.

274 Art. 12 Polish copyright act.

275 Art. 30 Hungarian copyright act.

276 Art. 3.3 Belgian copyright act

277 Art. 51 Spanish copyright act.

278 Art. 12ter Italian copyright act.

279 Art. L. 111-1 French copyright act.

refer to an automatic assignment of the authors' rights, save the cases in which exception to that principle is provided.

Finally, Denmark and Germany do not have specific provisions that apply to the works created by the employees:

- In Denmark a rule on assignment has been developed in case law. In respect of a permanent employee who has creation of works as a part of her job description, the copyright passes to the employer but only to the extent necessary for the normal business activities of the employer<sup>280</sup>.
- In Germany, the general rules of the section dedicated to the exploitation of rights apply to authors in employment. There is no specific rule that simplifies the use of works by the employer<sup>281</sup>.

The disparities between the Member States of the European Union in the legal treatment of the works created by employees are significant. They may lead to different outcomes in the determination of the initial owner of the rights on a work created by employees under the duties of their employment contract.

#### - Cinematographic and audiovisual works

As mentioned above, the Term of protection Directive (2006/116/EC), the Rental and Lending Rights Directive (2006/115/EC) and the Satellite and Cable Directive (93/83/EEC) have partially harmonised the notion of authorship in the field of cinematographic or audiovisual works. According to these directives the principal director of a film has to be considered as the author or one of the co-authors of the film. The Member States are free to designate other individuals, such as the author of the screenplay, the author of the dialogue or the composer of music, as co-authors.

The Court of Justice confirmed the status of the principal director of the film in the case *Luksan*:

*“The principal director of a cinematographic work must be regarded as having lawfully acquired, under European Union law, the right to own the intellectual property in that work. In those circumstances, the fact that national legislation denies him the exploitation rights at issue would be tantamount to depriving him of his lawfully acquired intellectual property right.”<sup>282</sup>*

Even if there are some disparities, all the Member States grant the authorship on an audiovisual work to more or less the same participants:

- The Belgian copyright act considers that the main director, the author of screenplay, the author of the adaptation, the author of the words, the graphical author and the author of the musical compositions are the joint authors of an audiovisual work<sup>283</sup>.
- In France, several contributors to the film are presumed to be the joint authors, namely the director, the author of the script, the author of the adaptation, the author of the dialogue and the author of the musical compositions specially composed for the work<sup>284</sup>. This is not an exhaustive list, others creators may also prove their creator quality.
- In Spain, the authors of the audiovisual work are the director, the author of the script and the adaptation, the author of the staging, the author of the dialogue, and the authors of the musical compositions created specifically for the work<sup>285</sup>.

---

280 Cf. the Supreme Court's judgment in the case reported in Ugeskrift for Retsvæsen 1978.901 H

281 Art. 43 German copyright act.

282 CJEU 9 February 2012, Case C-277/10, *Martin Luksan v Petrus van der Let*.

283 Art. 14 Belgian copyright act.

284 Art. L 113-7 French copyright act.

285 Art. 87 Spanish copyright act.



- In Germany, the joint authors are the principal film director, the author of the screenplay, the author of the dialogues and the composer of music specifically composed for use in the cinematographic work in question<sup>286</sup>.
- In Hungary, the authors of the literary and musical works prepared for a film, the director of the film and all the other persons having made creative contributions to the production of the film are joint authors of the audiovisual work<sup>287</sup>. The director of the film represents the other authors in the exercise of their rights.
- In Poland, the persons who have made a creative contribution to the establishment of the audiovisual work are the joint authors of that work. It includes the director, the director of photography, the author of the adaptation of a literary work, the author of musical or textual and musical works created for the audiovisual work and the author of the screenplay<sup>288</sup>.
- In Italy, the author of the story, the author of the screenplay, the composer of the music and the artistic director are joint-authors of a cinematographic work<sup>289</sup>.
- In Denmark, the authors are the principal director, the author of the script, the author of the dialogue and the composer of music specifically created for use in the cinematographic work<sup>290</sup>.
- In the Netherlands, the joint authors are the natural persons who have made a contribution of a creative nature to the making of the cinematographic work. It is unclear when a contribution is substantial enough to result in authorship for the contributor. Copyright in a cinematographic work expires 70 years after 1 January of the year following the year of death of the last of the following persons to survive: the principal director, the author of the screenplay, the author of the dialogue and the composer of the music created for use in the work<sup>291</sup>.

Different laws thus recognise different contributors as authors of the audiovisual or cinematographic work.

The existing disparities in the legislation of the Member States with regard to the determination of authorship on cinematographic or audiovisual works are mitigated by the existence, in all the European countries, of a legal presumption operating the transfer of the rights from the co-authors to the producer. Article 3 of the Directive 2006/115/EC expressly harmonises that legal presumption for the rental rights<sup>292</sup>.

In the case *Luksan*, the Court of Justice came to the conclusion that such a presumption was not an irrebuttable one. The Court also reminded that the existence of that presumption might not deprive the authors of their rights:

*“European Union law must be interpreted as allowing the Member States the option of laying down a presumption of transfer, in favour of the producer of a cinematographic work, of rights to exploit the cinematographic work such as those at issue in the main proceedings (satellite broadcasting right, reproduction right and any other right of communication to the public through the making available to the public), provided that such a presumption is not an irrebuttable one precluding the principal director of that work from agreeing otherwise.”<sup>293</sup>*

---

286 Art. 65 German copyright act.

287 Art. 64.2 Hungarian copyright act.

288 Art. 69 Polish copyright act.

289 Art. 44 Italian copyright act.

290 Art. 63.1 Danish copyright act.

291 Art. 40, 45a Dutch copyright act:

292 Art. 3.4. and 3.5. of the Directive 2006/115/EC: “4. Without prejudice to paragraph 6, when a contract concerning film production is concluded, individually or collectively, by performers with a film producer, the performer covered by this contract shall be presumed, subject to contractual clauses to the contrary, to have transferred his rental right, subject to Article 5.

5. Member States may provide for a similar presumption as set out in paragraph 4 with respect to authors.”

293 *Luksan*, par. 87.

Consequently, even if it can benefit from a legal transfer of rights, the producer will never be the initial owner of the rights on a cinematographic or audiovisual work.

### **(ii) Transfer of rights by way of contract**

When the copyright legislation does not by itself operate a transfer of the rights in favour of the person wanting to exploit a work, then a contract (assignment or licence) has to be concluded between that person and the owner of the rights.

E. DERCLAYE reminds that “*many aspects of copyright contract law are predicated, at least in part, upon cultural considerations, such as the desire to protect independent authorship against increasingly dominant media and entertainment conglomerates. At present, apart from a few areas of special European concern, such as consumer law, commercial agency and electronic commerce, contract law remains firmly a matter for the national legislatures*”<sup>294</sup>.

All Member States may impose obligations on copyright contracts of some sort (e.g. requirements of forms, scope of the transfer, determination of remuneration)<sup>295</sup>, but these conditions surely vary from one Member State to another. There are indeed many disparities regarding the rules applicable to copyright contracts between the legislations of the Member States.

According to the 2002 IViR study, in several countries the copyright legislation contains extensive measures of protection, which lay down specific rules of form and content. In other countries, the measures of protection are limited to a number of general principles of interpretation of copyright contracts. In yet other Member States, the copyright acts contain only scarce measures apart from the few provisions flowing from the implementation of European Directives or from the general principles of law<sup>296</sup>. We refer to the 2002 IViR study for a complete presentation of the rules applicable to copyright contracts in most of the Member States of the European Union.

### **c) Impact of the existing disparities**

In order to assess the impact of the existing disparities regarding authorship, ownership and transfer of rights, we will first summarise the current situation. We will then try to evaluate the consequences of such disparities.

#### **(i) Disparities on authorship, ownership and transfers of rights**

The disparities in the different copyright legislation observed in the report made by the IVIR in 2002 are still reflected in the legal systems of the Member States selected in the scope of the present Study. Indeed, at the European level, only a few provisions partially regulate the determination of authorship or the allocation of initial ownership of certain types of works.

Concerning the other kinds of works, the Member States remain free to determine the authorship / ownership of copyright, and, doing so, to deviate from the **creator doctrine**. Furthermore, in the absence of any harmonisation of that topic, the Member States are also free in the way they apply the creator doctrine. As a result, some countries admit that a person other than the actual creator of the work

---

294 E. DERCLAYE, *Research handbook on the future of EU copyright*, Edward Elgar Publishing, 2009, 526

295 Communication from the Commission to the Council, the European Parliament and the European Economic and Social Committee “The Management of Copyright and Related Rights in the Internal Market”, Brussels, 16 april 2004, COM(2004) 261 final.

296 L. GUIBAULT and B. HUGENHOLTZ, *Study on the conditions applicable to contracts relating to intellectual property in the European Union*, 145.

(including legal persons) who was particularly involved in the creation of the work be the initial owner of the rights, while other countries stick to a strict application of the creator doctrine.

The same kind of disparities affect the authorship on works created in the course of an **employment** contract. In France or in Belgium, an employee is the owner of the copyright on his work. However, in Belgium, the copyright act contains specific rules that facilitate the transfer of the employee's rights to the employer. In the United Kingdom, by contrast, the employer is the initial owner of the copyright on the works created by his employees in the execution of their employment contract.

The concept of **collective works** is another example of a particular regime determining the ownership on a work, which exists in some Member States but not in others.

Even if the rules determining the authorship on **audiovisual or cinematographic works** have been partially harmonised, it does not prevent the existence of remaining disparities between the Member States. However the impact of the existing disparities with regard to audiovisual and cinematographic works is mitigated by the existence of a legal presumption of transfer of the rights in favour of the producer, which is laid down in the copyright legislation of the Member States.

Finally, the legislation of the Member States on copyright contracts also reflects various tendencies that ensure a bigger or lower protection to the authors.

In theory the disparity of rules on authorship and ownership complicates the exercise of the making available right. The making available right protects a complex act, consisting of certain material acts that may take place in several Member States (Sportradar, par. 34). It is assumed that each of such constitutive elements requires the consent in the Member State where it is deemed to take place, where the remuneration should also be paid (cf. Premier League, par. 111).

Considering that the constitutive elements of the complex act of making available to the public may be localised in several Member States, different persons may be entitled to exercise this right by virtue of the national copyright rules<sup>297</sup>. It is not merely a matter of applicable law. Instead, a cross-border act, consisting of constitutive elements, may justify finding distinct infringements that may be localised in various Member States. In that case, any act of exploitation should be authorised by all persons who hold rights in the Member States where a constitutive element of the making available may be localised.

This means that a service provider is expected to acquire the consent of the person holding the rights in each Member State where a constitutive element of complex act of making available can be found. Given the circumstance that this may not be the same person in each relevant Member State, the candidate-licensee should verify who owns which rights for the territory where such relevant act is performed. The uncertainty with regard to the definition of the making available right and the localisation criteria may thus affect the position of this candidate-licensee. Inversely, a right holder should verify whether she holds the relevant rights in each territory where an infringement may be found.

The consequences of the disparities mentioned above will become clearer in the following example. The operator of a news website wants to publish an article written by a journalist who is an employee of the publisher of the newspaper where the article was first published.

- In France, the journalist (as the creator of the work) will be the author of the article. The French copyright act organises a legal transfer of the rights from the journalist to the editor, unless otherwise provided (Art. L. 132-36 French Copyright Act). Yet the exploitation of the news article

---

<sup>297</sup> See on this point Advocate-General KOKOTT's opinion in Premier League, par. 153 : "As recital 7 in the preamble to Directive 93/83 explains, prior to the adoption of the directive, there was legal uncertainty as to whether broadcasting by a satellite whose signals can be received directly affects the rights in the country of transmission only or in all countries of reception together. A cumulation would not only give rise to the simultaneous application of different legal orders. The rights to the broadcast could also be enjoyed by different holders in different Member States. A cumulation could therefore render satellite broadcasts excessively difficult or even impossible".

outside the newspapers of the editor's group requires the author's consent as well (art. L. 132-40 French Copyright Act)<sup>298</sup>. As a consequence, the news website will have to acquire the journalist's and the editor's authorisations to make the article available on its platform.

- According to Belgian law, the journalist (as the creator of the work) will be the owner of the rights. However, the newspaper publisher has an employment contract with the journalist. If this contract expressly specifies a transfer of rights from the journalist to the employer, then the newspaper publisher alone holds the economic rights. The news site operator should seek the publisher's consent. Although the conditions for a valid transfer are attenuated in this case, the transfer of right should still be stipulated in the contract. Without such provision, the journalist remains the sole holder of her rights.
- According to British law, the newspaper publisher may be the initial owner of the rights if it has specifically taken the initiative of the work.

Depending on the applicable national law, the journalist has a more or less solid bargaining position and, inversely, the publisher enjoys a more or less comfortable position regarding the acquisition of copyrights. Consequently the operator of the news site wanting to use the article should turn to either the journalist, the publisher or both. It is therefore important to determine which legislation will apply in case of international situations.

For example, a news aggregator with its servers in England offers a news service that is accessible everywhere in Europe. It offers the possibility to select the news reports per Member State, e.g. Belgium. Some news articles published in the French press are also displayed for the Belgian public.

Depending on the constitutive elements of the making available right (hosting, transmission, targeting), relevant acts may be found in England (servers), Belgium (targeted public) or the rest of Europe (accessibility). The service provider (wanting to avoid any risk of infringing the rights to the French article) should therefore clear the rights in each of Member States where a relevant act takes place. The hosting of the article is the first act and it takes place in the UK. Regardless of a contractual transfer of ownership, the employer of the journalist should authorise this use (the French publisher of the news article). The news aggregator offers Belgian news hence, somewhat simplifying, it could be derived that it targets the Belgian public. In that case a relevant act takes place in Belgium, where the author/journalist is considered the initial holder of the making available right. But the news aggregation service is accessible anywhere in Europe and the news article may be transmitted to any Member State. In that case relevant acts may take place in any Member State, where the rights of making available should be cleared as well.

#### - Consequences of the current situation

We have presented the rules on applicable law above. We explained that there was a controversy with regard to the law applicable to the initial ownership (*lex loci originis* vs *lex loci protectionis*). That controversy was the reason of the litigation that led to the decision of the French Cour de cassation on 10 April 2013 in the dispute between the American broadcasting company and its former photographer<sup>299</sup>.

Under the *lex loci protectionis* applied to treat the issues of initial ownership, the following scenario could occur. A person defined as the initial owner of copyright in the country of first publication (country A) could lose his rights in favour of another person in the country of exploitation (country B) at least for that exploitation, if country B (as the *locus protectionis*) has different rules on authorship.

---

298 A. LUCAS e.a., *Traité de la propriété littéraire et artistique*, 183-184.

299 Cass. (fr.), 10 April 2013, <http://www.legifrance.gouv.fr/>

Returning to our example, this would mean that a journalist working under a Belgian employment contract who has not expressly assigned her rights to her employer would have to be considered as the initial right holder on the articles that are first published in Belgium. However, if an English operator of the news site wants to exploit the works in England, the English copyright act would be applied (as the *lex loci protectionis*) to determine the initial holder of the rights, i.e. the publisher of the newspaper (as the journalist's employer). Such outcome would affect the rights acquired by the right holders.

On the contrary, the application of the *lex loci originis* would provide more legal certainty, as the initial owner of copyright would always remain the same person.

It should follow from the existing disparities between the national rules on authorship and ownership that the exercise of the making available right inevitably lead to a deadlock, at least to numerous complications each time a work is made available online. The making available right indeed protects a complex act, which may consist of relevant material acts that may take place in several Member States. Depending on the constitutive elements protected under this right and the localisation criteria applied, the rights of making available to the public should then be cleared for each relevant act in the Member State where it takes place, from the person who holds the right according to the national rules on this point.

In practice, we have found no such conflicts in the cases reported in the Member States under consideration. This suggests that the disparity of national rules on authorship and ownership is not insurmountable. On the other hand it may entail a transaction cost in contractual practice, which is not reflected in litigation before the courts.

Despite the existence of the disparities listed above and despite the complexity of the rules of private international law, IViR concluded that there was no actual need to harmonise the rules on authorship at the European level:

*"Intuitively, we would tend to believe that the disparities we found may not be so important as to affect the efficient functioning of the Internal Market. A first indication that the impact on the Internal Market may be somewhat limited is that, to our knowledge, neither the European Court of Justice nor the national courts have had to decide a case where the application of the rules on copyright contracts of one Member States raised problems in another Member State. A second indication comes from the fact that there appears to be a general consensus among Member States on a number of important issues. (...)*

*In light of our findings and for the various reasons mentioned in subsections 6.2 and 6.3 above, a Community initiative on the harmonisation of the rules on copyright contracts may be, at the present stage, wholly premature.*"<sup>300</sup>

E. DERCLAYE recently recalled the existence of these disparities with regard to copyright contracts and stressed on the absence of an actual impact on the functioning of the Internal Market:

*"In view of the fact that there seems to be no real indication that the functioning of the common market urgently requires the approximation of the laws of the Member States in this area, it is therefore questionable whether an action from the European legislator towards the harmonization of the rules on copyright contracts would be consistent with article 5 of the Treaty establishing the European Community."*<sup>301</sup>

---

300 L. GUIBAULT and B. HUGENHOLTZ, Study on the conditions applicable to contracts relating to intellectual property in the European Union, 149-154.

301 E. DERCLAYE, Research handbook on the future of EU copyright, 526.

The stakeholders who responded to the consultation on the online distribution of audiovisual works in the European Union seemed to be divided on the question whether a harmonisation of the notion of authorship in the field of audiovisual works is needed<sup>302</sup>.

In a recent paper, M. VAN EECHOUDE wrote that the Court of Justice might be questioned in the future in order to define the notion of authorship if no directive intervenes to regulate that concept:

*“Inevitably, I would think, once national courts are taken further down the road to an all-inclusive Community-wide notion of what constitutes a work, there will be no escape from a Community-wide notion of authorship (and initial ownership).(...)*

*The numbers of copyright cases brought before the Court of Justice are rising, and the Court shows itself rather activist and willing to construct pan-European notions of copyright that are not clearly in (or even squarely out of) the directives.”<sup>303</sup>*

In the current context, the actual need to harmonise the concept of authorship at the European level is difficult to evaluate. The stakeholders adopt different, and even opposite, positions on that issue. Furthermore, we are not aware of the existence of any case-law resulting from that problematic. However, the theoretical hypothesis we have presented shows that the current situation may hamper the conclusion of pan-European licences. An economic market study would be needed to evaluate the real impact of the existing disparities.

Moreover, it should be taken into account that the harmonisation of the rules of authorship and (initial) ownership are not the only causes for fragmented ownership of copyright works. The rights are commonly transferred by contract or licensed by territory. To the extent that an act of making available covers various constitutive elements that may take place in different Member States, the issue remains that several persons' consent should be obtained – the difference being that these persons are indicated by contract rather than by national law.

### 3. Reproduction right

The making available right is considered, in the InfoSoc Directive, as a species of the right of communication to the public. The Directive does not regulate the relation between the rights of reproduction, communication to the public and distribution. Yet these rights may apply, even simultaneously, to the same technical process. A typical instance of on demand availability may be represented by the following schema:

---

302 Green Paper on the online distribution of audiovisual works in the European Union: opportunities and challenges towards a digital single market. The contributions to the public consultation can be found at [http://ec.europa.eu/internal\\_market/consultations/2011/audiovisual/](http://ec.europa.eu/internal_market/consultations/2011/audiovisual/).

303 M. VAN EECHOUDE, “Along the Road to Uniformity Diverse Readings of the Court of Justice Judgments on Copyright Work”, 3 (2012) JIPITEC, 1, 76.

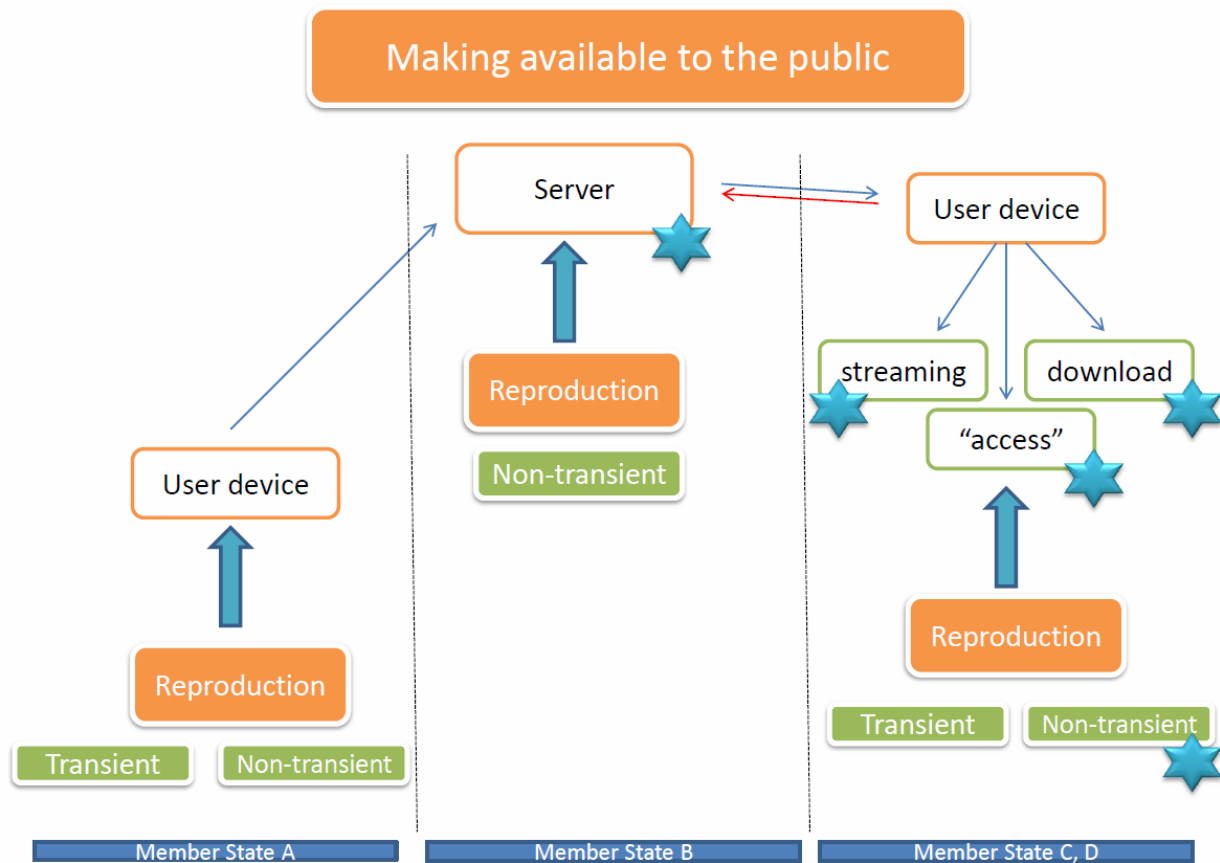

A work may be uploaded from a user device to a server, where it is stored and members of the public have the possibility to access the work from their own devices.

The level of control that the user can exert depends on the technology chosen by the uploader<sup>304</sup> and on the (commercial) customs.

- **Download** (e.g. music, films, newspapers). The end user will receive the most complete control and independence of the uploader who has made the work initially available: the user stores her own copy of the work and can see, hear or read it whenever she likes.
- **Streaming** (mostly audio or audiovisual content). A work that is streamed to the end user will remain in the latter's possession only for the purpose of seeing or hearing it. No permanent copy is saved at the user's end. For a later use, the final user depends on the availability of the work at the uploader's end.

304 In this report the "uploader" refers to the person performing the act of upload that leads to the work being accessible to a public. We prefer to use the term "uploader", since it refers to a material act of upload rather than the legal qualification "making available". Also, it contains no bias with regard to the liability for the act of making a work available to the public. The uploader could be a natural person, sharing a work via social media, via peer-to-peer networks or via a blog, or a legal entity with or without commercial intent, such as the provider of online music services or a film platform.

- **Other forms of access** (e.g. news sites or blogs). The user loads copies of web pages while “browsing” in order to access the content of the page. These copies may subsist as long as the user remains on the page or even until the browsing programme is closed.

It appears from this simplified scheme that the act of making available involves a number of copies, at distinct stages of the technical process. It should thus be verified for each of these copies whether these are reproductions (art. 2 InfoSoc Dir) and whether these may be exempted under the exception for temporary acts of reproduction (art. 5(1) InfoSoc Dir).

The key question is how the rights of making available and reproduction relate in case a work is offered to the public on its demand. We will hereafter proceed to a brief analysis of the reproduction right (art. 2 InfoSoc Dir) and the exception for temporary acts of reproduction (art. 5(1) InfoSoc Dir). Based on the findings of this examination, we will proceed to the identification of the (protected) reproductions in different use cases of on demand exploitation.

### a) Scope of the reproduction right in the InfoSoc Directive

The scope of protection of the reproduction right is determined by a combined reading of the reproduction right (art. 2 InfoSoc Dir) and the exception for temporary acts of reproduction (art. 5(1) InfoSoc Dir). Both will be discussed here, as this particular exception plays the role of correcting the excessive protection under the broad reproduction right. Remarkably, the reproduction right requires less explanation than the exception (cf. relevant decisions of the CJEU). The conditions of this exception are indeed complex to interpret and to apply. Although this exception is not exclusively connected to the making available right, its uncertain scope of application has important consequences for the harmonising effect of the making available right. We have therefore considered it important to undertake an analysis of this exception and its interpretation by the CJEU,

#### (i) *The reproduction right*

The reproduction right is the exclusive right to authorise or prohibit direct or indirect, temporary or permanent **reproduction** by any means and in any form, in whole or in part (art. 2 InfoSoc Dir).

The relation between the making available right and the reproduction right has not been regulated in the InfoSoc Directive. The rights of reproduction and communication to the public are autonomous rights, which can apply cumulatively.

The reproduction right is understood in a broad way (rec. 21 InfoSoc Dir)<sup>305</sup>. From the Information Society Directive, its preparatory works and the cases decided by the CJEU, it can be stated, generally, that the reproduction right protects the material act of copying, including transient copies in cache memories, satellite decoders or television screens<sup>306</sup>. The CJEU stated indeed that this right extends to transient copies, which may have an “*ephemeral existence because they are immediately effaced in the course of a technical process*”<sup>307</sup>. The result is that it suffices to find a reproduction in the material sense (a “copy”) in order to find a reproduction in the sense of the InfoSoc Directive, regardless of the function or the economic value of the copy (technical approach).

The principle of **territoriality** governs the reproduction right (similarly to the making available right). This means that the Member State where reproduction is performed is competent to regulate the behaviour. It may not be so straightforward to localise the reproduction. At first glance, the restricted act takes place where the copy is made. But, in the current technological framework, the person who *makes* the reproduction may be in a different Member State than where the copy is stored (server – cf. third party

---

305 Infopaq I, par. 43.

306 Premier League.

307 Premier League, par. 157.



hosting or cloud services). The localisation criterion for the reproduction right has not been harmonised, hence national legislations may differ in this respect.

The copyright law of this Member State determines the transfer of rights or which (facultative) exceptions apply.

The reproduction right as such is harmonised under the InfoSoc Directive. Another question is who should be regarded as the **person who reproduces** the work. The answer will determine who has the obligation to obtain the author's consent for the reproduction or who can benefit from an exemption in the national copyright legislation. It seems that the Member States answer this question in different ways.

In simple cases where only one actor is involved, the answer is straightforward: the person who makes the reproduction should acquire the author's consent. For example, the person who copies the music from a CD to the hard drive of her computer is the person who reproduces the work. The answer is less obvious when several actors play different roles, in particular when a technical intermediary is involved (such as a copy centre or an Internet service provider). Member States focus on different elements to decide who is responsible for a reproduction. A few examples will illustrate the differences.

In France it is generally held that the person who makes the material copy of a work – or even who intervenes in the reproduction by providing the technical means to do so – is responsible for the reproduction, even if she has acted upon the request of a final user (e.g. the user of a virtual personal video recording system)<sup>308</sup>. It seems that the same solution is adopted under Spanish law<sup>309</sup>.

In Germany, it was held at several instances that the user of a “virtual personal video recorder” may make the reproductions of protected television programmes, not the company offering the online video recording service<sup>310</sup>. If the user indeed “produces” the recording then it may be covered under the exception for private use (even if one copy served for the recordings of several clients). In respect of Rapidshare, it was held that not the service provider but the user of the service made the reproduction of the works<sup>311</sup>. According to the Belgian Supreme Court, the person who materially makes the reproduction or who orders it should acquire the author's consent or qualify for an exception, even if the reproduction is made in a copy centre<sup>312</sup>.

In the *Meltwater* cases, the question was whether the customer of a press monitoring company made protected reproductions when she receives the press overviews per e-mail or when she views these overviews on the website of the company. The copies made while browsing gave rise to a debate on the application of the exception for transient copies (*infra sub* (ii)). On the email copy, it was considered

---

308 Cour d'appel de Paris Pôle 5 (chambre 1), 14 December 2011, *Wizzgo c Metropole Television et autres* (2011). Retrieved from [http://www.legalis.net/spip.php?page=jurisprudence-decision&id\\_article=3297](http://www.legalis.net/spip.php?page=jurisprudence-decision&id_article=3297). See T. VERBIEST, M. DE BELLEFROID, A. SOKOLOWSKA, « Le régime de l'exception de la copie privée en droit français », *Droit & Technologies*, 10 September 2007, <http://www.droit-technologie.org/actuality-1070/le-regime-de-l-exception-de-la-copie-privee-en-droit-francais.html> (consulted 3 December 2012); J. MARTIN, Réponse du groupe français au questionnaire relatif au congrès de l'association littéraire artistique internationale Kyoto octobre 2012, [http://www.alai.jp/ALAI2012/program/national\\_report/France.pdf](http://www.alai.jp/ALAI2012/program/national_report/France.pdf) (consulted 3 December 2012).

309 R. CASAS e.a., ALAI-Study Days 2012 – KYOTO. Questionnaire Spain, 2012, [http://www.alai.jp/ALAI2012/program/national\\_report/Spain.pdf](http://www.alai.jp/ALAI2012/program/national_report/Spain.pdf) (consulted 3 December 2012), p. 11. Some reservations are expressed for the copies kept by means of cloud services.

310 Bundesgerichtshof 22 April 2009, I ZR 175/07, “Save.tv”. See A. GIEDKE, ALAI Congress 2012 – Kyoto Questionnaire – Germany, 2012, [http://www.alai.jp/ALAI2012/program/national\\_report/Germany.pdf](http://www.alai.jp/ALAI2012/program/national_report/Germany.pdf) (consulted 3 December 2012), p. 23.

311 OLG Düsseldorf 27 April 2010, case I-20 U 166/09 in the German section's contribution to the ALAI's Kyoto congress 2012 on cloud computing, p. 25, accessible via [http://www.alai.jp/ALAI2012/program/national\\_report/Germany.pdf](http://www.alai.jp/ALAI2012/program/national_report/Germany.pdf).

312 Cass.bel. 27 May 2005, dock nr. C.03.0610.N, SABAM, I.F.P.I. v Goossens, A&M 2005, 414.

common ground that Metlwater's customers need a licence for this reproduction, which is not a temporary one<sup>313</sup>.

These few illustrations suffice to observe that diametrically opposed principles may be followed in different Member States. Member States may see either the ultimate beneficiary of the copy (final user) or technical copier (the service provider) as the person who reproduces the work. That person either has to obtain the authorisation or qualify for an exception. It follows that it has to be verified, for each reproduction, which national principles apply (taking into consideration the conflict of law rules) and to which effect. One possible outcome is that the reproduction requires the author's consent, to be acquired either by the service provider or by the final user (who ordered the reproduction and/or benefits from it). Another possible outcome is that the national copyright act contains an exemption in favour of the final user that is not ruled out because of the intervention of the service provider<sup>314</sup>.

### **(ii) The exception for temporary acts of reproduction**

The scope of protection of the reproduction right is further determined by the (mandatory) **exception for temporary acts of reproduction**, which are transient or incidental [and] an integral and essential part of a technological process and whose sole purpose is to enable: (a) a transmission in a network between third parties by an intermediary, or (b) a lawful use of a work or other subject-matter to be made, and which have no independent economic significance (art. 5(1) InfoSoc Directive).

This exception will, generally speaking, exempt transient copies with a merely technical function and without any independent economic significance. Recurring examples were the technical copies that enable "browsing" and "caching" (see also cons. 33 of the directive).

We will examine this exception to the reproduction right because the scope of application of the exception has an impact on the exercise of the making available right. The exception for temporary acts of reproduction is not exclusively linked to the making available right, but inversely the making available right (in a digital environment) will in many cases entail reproductions and the exception for temporary acts of reproduction. Any uncertainty regarding the scope of the exception will weigh on the application of the making available right.

It is often presumed that works made available for download result in a reproduction, at the downloader's end, that requires a prior consent, while works that are streamed at the user's demand lead to reproductions that are exempted under art. 5(1) InfoSoc Dir. This hypothesis should be verified in the light of the recent decisions of the CJEU. Any indication that not all temporary copies that enable the "consumptive" use of a work are exempted entails that the restrictions or exemptions are applied at the discretion of the Member States and that the global application of the making available right is less harmonised than presumed (cf. the controversial decisions in the *Meltwater* case in the UK - *infra*).

We will first examine the CJEU's decisions in relation with art. 5(1) InfoSoc Directive, then we will highlight the uncertainties in relation to temporary copies following a transmission at the demand of the user.

---

313 UK Supreme Court 17 April 2013, *Public Relations Consultants Association Limited v The Newspaper Licensing Agency Limited and others*, [2013] UKSC 18, accessible via [http://www.supremecourt.gov.uk/decided-cases/docs/UKSC\\_2011\\_0202\\_Judgment.pdf](http://www.supremecourt.gov.uk/decided-cases/docs/UKSC_2011_0202_Judgment.pdf), (UKSC *Meltwater*), par. 4.

314 Other solutions have been developed at the national level. In Germany, inconsistencies in the licensing of the making available right and associated reproductions have been tackled via the conditions for valid licences (centred on the exploitation of a work, not the economic rights as such). See LG München 25 June 2009 and OLG München 24 April 2010. An appeal before the Bundesgerichtshof is pending. In Canada, the Supreme Court has approached this issue differently, by giving guidelines on the qualification of resp. on demand downloads and streaming as either reproductions or communications to the public via telecommunication.

- *Infopaq I & II and Premier League*

The CJEU has interpreted several of these cumulative conditions of this exception in the cases “Infopaq” I and II and “Premier League”, in relation to other technologies than Internet-related technologies. The combined reading of these cases does not make the application of the exception for temporary acts of reproduction any less complicated. Generally, the Court stated that the conditions are cumulative (Infopaq I, par. 55) and that the exception should be interpreted restrictively (Infopaq I, par. 56; FAPL, par. 162). The strict interpretation should however not prevent the exception from being effective and achieving the exception’s purpose (i.e. *“the development and operation of new technologies and safeguard a fair balance between the rights and interests of right holders, on the one hand, and of users of protected works who wish to avail themselves of those new technologies, on the other”* – Premier League, par. 163-164)

Firstly, the Court interpreted the condition that the reproductions should be **transient**. In the first Infopaq decision, the Court was asked to rule on the reproductions that were part of a “data capture process”. Infopaq is a Danish media monitoring service, which supplies its customers with *inter alia* summaries of press articles. Part of its work was automated by this “data capture process”, designed by Infopaq. The first question was whether the reproductions, made in this context, were exempted under the exception for temporary acts of reproduction. The Court stated that the an act can be held to be ‘transient’ *“only if its duration is limited to what is necessary for the proper completion of the technological process in question, it being understood that that process must be automated so that it deletes that act automatically, without human intervention, once its function of enabling the completion of such a process has come to an end”* (Infopaq I, par. 64). This means that the transient character of the reproduction should be assessed by reference to the “proper completion” of the technological process (a relative rather than an absolute assessment). A paper print is a reproduction outside the computer sphere and its deletion is not decided by the automated process: the reproduction disappears only when the material support is destroyed and when the user decides to do so (Infopaq I, par. 67). Such reproduction is not transient and cannot be exempted under this exception.

In the second Infopaq case, the Court ruled on the condition that the reproduction should be an **integral and essential part of a technological process**.

This condition means, on the one hand, that the temporary acts of reproduction are carried out *“entirely in the context of the implementation of the technological process and, therefore, not to be carried out, fully or partially, outside of such a process”*. On the other hand, the Court stated that *“this concept also assumes that the completion of the temporary act of reproduction is necessary, in that the technological process concerned could not function correctly and efficiently without that act”* (Infopaq II, par. 30). Again the reference is the technological process (in particular the necessity of the reproduction for its correct and efficient functioning). The Court described the technological process as consisting of *“carrying out electronic and automatic research in newspaper articles and identifying and extracting predefined key words from those articles, in order to render the drafting of summaries of newspaper articles more efficient”* (Infopaq II, par. 33) and its aim was to *“identify predefined key words in newspaper articles and extracting them on a digital medium”* (Infopaq II, par. 37). Summarising the newspaper articles by contrast was an act outside the process; the fact that it is possible to summarise articles without these reproductions was not pertinent (i.e. the reproductions are not necessary to make such summaries). All digital reproductions were therefore necessary for the correct and efficient functioning of the “data capture” process. It mattered not that the reproductions were initiated by a human intervention or that they intervened at the beginning or at the end of the process.

The next legal condition requires that the **sole purpose** of the process is either to enable a transmission in a network between third parties by an intermediary or a lawful use.

Firstly, the technical copies may be exempted under this exception if the purpose is to does the **transmission in a network** by an intermediary. It is explained that these copies should *“enable transmission systems to function efficiently, provided that the intermediary does not modify the information and does not interfere with the lawful use of technology, widely recognised and used by*

*industry, to obtain data on the use of the information*" (rec. 33 InfoSoc Dir). This element does not seem to raise too many difficulties.

Secondly, the technical copies should enable a **lawful purpose**. It is clarified that "*a use should be considered lawful where it is authorised by the rightholder or not restricted by law*" (rec. 33 InfoSoc Dir). This possibility has been interpreted by the Court of Justice in *Infopaq II* and *Premier League*.

A use is considered lawful "*where it is authorised by the rightholder or not restricted by law*" (rec. 33 InfoSoc Dir). This condition was applied in the Court's ruling in *Premier League* and in *Infopaq II*, to two very different sets of facts. In *Premier*, it was decided that the technical copies made in the satellite decoder and the television screen could indeed constitute reproductions (provided that these were "partial" reproductions). Answering the question whether they served a lawful purpose, the Court firstly identified the intended use. The Court found that these ephemeral reproductions enabled the satellite decoder and the television screen to function correctly and that, from the television viewers' standpoint, they enable the broadcasts containing protected works to be received (*Premier League*, par. 170). It went on to evaluate whether the intended use was lawful. The reproductions were not authorised so the Court had to assess whether the use of works was "*not restricted by the applicable legislation*" (*Premier League*, par. 169). In this sense, it stated that "*mere reception as such of those broadcasts – that is to say, the picking up of the broadcasts and their visual display – in private circles does not reveal an act restricted by European Union legislation or by that of the United Kingdom (...) and that act is therefore lawful*" (*Premier League*, par. 171). It should be noted that the Court did not consider that fact that in this case the broadcasts were not received in private circles but, on the contrary, to be shown in a public space (i.e. a pub). In *Infopaq II*, the Court proceeded in a similar way (par. 43-44). Firstly, it identified the intended purpose (a more efficient drafting of summaries of newspaper articles, i.e. a use of those articles) and it remarked that this was its sole purpose (there being no indications that the reproductions were used for any other use). Then it verified whether the intended use (the facilitated drafting of summaries) was restricted under European<sup>315</sup> or Danish law, which was not the case. It should be noted that the Court did not require that the intended use be integral part of the technological process (the drafting of summaries being a technically independent act), it suffices that there were no indications that the technical process was used for another purpose. Another noteworthy element is that the Court did not seek to verify whether the intended use was covered under one of the exceptions. It results that a lawful use may consist of an intended use that is authorised, exempted under a legal exception or one that is not restricted by the applicable legislation.

Finally, the temporary act of reproduction should not have an **independent economic significance**. Reproductions that make access to a work possible have an economic significance (*Premier League*, par. 174): since the works have an economic significance, access to the works has an economic significance and therefore the reproductions that enable this access have an economic significance. This fact by itself does not preclude the application of the exception, as long as the reproduction does not have an *independent* economic significance. The Court found that the reproductions are not capable of generating an additional economic advantage, beyond the advantage derived for the intended use (i.e. the mere reception of the broadcast) and that they do not have a separate economic significance. The Court derives this from the fact that these copies are an "inseparable and non-autonomous part of the process of reception" (*Premier League*, par. 176). Similarly, in *Infopaq II*, it was ruled that reproductions that facilitate a use or make it more efficient (efficiency gains, reduced costs, increased profits) have an economic significance. No economic advantages distinct or separable from the economic advantages derived from the use of the works were found, provided that "*the implementation of those acts does not enable the generation of an additional profit, going beyond that derived from lawful use of the protected work and, secondly, that the acts of temporary reproduction do not lead to a modification of that work*" (*Infopaq II*, par. 54).

---

315 It should be remarked that the InfoSoc Directive does not harmonise the adaptation right, which may in some jurisdictions protect that drafting of summaries of protected works.

As far as the compliance with the three-step test is concerned, the Court sufficed to observe that the reproductions that meet the conditions of art. 5(1) InfoSoc Directive do not conflict with the three-step test in art. 5(5) InfoSoc Dir.

- **Uncertainties**

These decisions raise important **uncertainties**, both in relation to internet technologies and other technologies.

One of the main uncertainties resulting from these decisions is how to understand the “technological process” and its relation to the “sole” purpose it should be enabling.

In *Premier League* the Court identified the “mere” reception of the television broadcasts via the satellite decoder and the television screen as the intended purpose. It did not take into consideration that, in this case, the television screen was placed in a public space and that the broadcast football matches were displayed to a public – an act that the Court subsequently qualified as an act of communication to the public (*Premier League*, par. 207). Instead, the intended use seemed to coincide with the proper technological process of each device (reflecting the ephemeral character of television broadcasts).

By contrast in *Infopaq II*, the intended purpose of the data capture process was to make summaries of the Danish press articles (not a restricted act under Danish law). The intended purpose in this case was (technically) outside of that technological process (*Infopaq II*, par. 38). The “data capture” process thus covered 3 digital reproductions (ending with a reproduction in the form of a digital file comprising the relevant 11-word fragments of the articles). It seems that an inherent technical connection between the technological process (i.e. the data capture process) and the intended purpose (the press summaries) is not required. The Court could have identified the last reproduction (of the relevant fragments in one digital file) as the intended purpose (as defined by the technological process itself) and assessed its lawful character independently of the subsequent use. However, the Court was satisfied with the observation that there were no indications that the result of the data capture process was used for any other purpose than the summaries of the press articles. It could be observed that this finding contrasts sharply with the legal security the Court required when it demanded that all reproductions be part of an automated process and that their subsistence not depend on the sole volition of the user of the work.

It is difficult to derive general guidelines from these fact-specific cases. The different approaches make it difficult to assess other technologies and the reproductions they generate in the light of the exception for temporary acts of reproduction. This is especially true for the act of “browsing”, the example given in recital 33 of the InfoSoc Directive.

A closely related issue was addressed in the British decisions in the “Meltwater” case<sup>316</sup>. The **facts** of this case were the following. A dispute arose between, on the one hand, The Newspaper Licensing Agency (NLA) and six newspaper publishers (acting as claimants) and, on the other hand, Meltwater (Holding and UK) and Public Relations Consultants Association (PRCA) (acting as defendants). Meltwater is a company that provides commercial media monitoring services (online only). PRCA was a customer of Meltwater, which received the media monitoring service. In order to offer its service, Meltwater “spidered” and indexed news websites. By means of search terms, defined by its customers, it established a monitoring report (consisting of a hyperlink with the headline of the article, the opening text, an extract in the form of a fragment surrounding each search term). Finally, Meltwater sent an e-mail containing the monitoring report to its customer or granted her access to the Meltwater website. For its own activities, Meltwater concluded a “Web Database Licence” with NLA. This Web Database Licence was however conditional upon the acquisition of a Web End-User Licence (WEUL) by Meltwater’s customers.

---

316 High Court of Justice's decision of 26 November 2010, [2010] EWHC 3099 (Ch); Court of appeal's decision of 27 July 2011, [2011] EWCA Civ 890. An appeal to the UK's Supreme Court has been admitted: <http://the1709blog.blogspot.be/2011/11/meltwater-appeal-to-go-to-supreme-court.html>.

The question was whether the copyright protecting newspaper articles is infringed, when an end-user receives an e-mail containing a press reports or accesses this report via her computer screen. It was admitted that both the reception of an e-mail and the viewing of the report involve reproductions, the legal issue resided in the application of the exception for temporary acts of reproduction.

The **High Court** decided in 2010 that the end-users' acts were not exempted under the exception for temporary acts of reproduction. The Court of appeal confirmed this ruling in 2011 and dismissed the appeal (without adding much to the analysis of the legal issues). It was thus decided that the end-user infringes copyright (*prima facie*) since she makes a copy of the work when receiving an email or when accessing it on a website via a computer. In relation to the exception for temporary acts of reproduction, the High Court found that it was not applicable. The exception only applies to "*incidental and intermediate copying so that any copy which is consumption of the work, whether temporary or not, requires the permission of the copyright holder*". The copy is made by the end-user, "*by his own volition*", it is not part of the technological process: it is the end of the process and "*storage of the copy and the duration of that storage are matters within the End User's control*". The end user must therefore demonstrate that the copy was lawful. Finally that copy does have an independent economic significance, since the end user is paying Meltwater for it.

The UK Supreme Court came to a different conclusion. Summarising the decisions of the CJEU in *Infopaq I & II* and in *Premier League*<sup>317</sup>, the Supreme Court found firstly that art. 5(1) InfoSoc Dir applies to temporary copies generated by an end-user's use of the internet that enable her to view copyright material on the internet, by reference to rec. 33 of the directive, the text of the directive (in art. 5(1)(b)) and the CJEU's decisions in *Premier League* and *Infopaq II* (UKSC Meltwater, par. 27). Having established this, the Court held that "*the various conditions laid down by that article must be construed so far as possible in a manner consistent with that purpose. It must, if the exception is to be coherent, apply to the ordinary technical processes associated with internet browsing*" (UKSC Meltwater, par. 28). The Supreme Court accepted that these temporary copies met the conditions that they be an integral and essential part of a technological process, that the use was lawful and that the temporary copies had no independent economic significance (UKSC Meltwater, par. 29). The Supreme Court also found the copies transient and temporary, since they met the two conditions (1) that the storage and deletion of the material be automatic, as opposed to being dependent on the discretionary human intervention and (2) that the duration of the copy be limited to what is "necessary for the completion of the technological process in question" (UKSC Meltwater, par. 31). These copies in the cache or on screen were considered the "*automatic result of browsing the internet. It requires no other human intervention than the decision to access the relevant web-page. Its deletion is the equally automatic result of the lapse of time coupled with the continuing use of the browser*"; Web browsing is enabled by some technological processes, including the retention of material in cache for a duration that does not exceed the ordinary processes associated with (normal) internet use. The Court then reminded that the purpose of the exception was to distinguish between the use of equipment to view copyright works and its use to record it: downloads or other permanent copies that remain in existence until the user chooses to delete or destroy them are not exempted under this exception (UKSC Meltwater, par. 31). The Supreme Court repeated twice that the act of reading or viewing has never been a copyright infringement (UKSC Meltwater, par. 1; 36) and this should not be altered because of the high level of protection under the directive. The opposite interpretation would make internet users vulnerable to civil liability when they merely browse the Web and end up on a page containing copyright works. Although the Supreme Court had come to the decision that the temporary copies in the cache memories and on the screens during the browsing process were exempted under art. 5(1), it expressed the intention of referring the matter to the

---

317 UK Supreme Court 17 April 2013, *Public Relations Consultants Association Limited v The Newspaper Licensing Agency Limited and others*, [2013] UKSC 18, accessible via [http://www.supremecourt.gov.uk/decided-cases/docs/UKSC\\_2011\\_0202\\_Judgment.pdf](http://www.supremecourt.gov.uk/decided-cases/docs/UKSC_2011_0202_Judgment.pdf), (UKSC Meltwater).

CJEU for a preliminary question given the transnational dimension and the implications for many millions of people across the EU using the internet (*UKSC Meltwater*, par. 38)<sup>318</sup>.

The uncertainty on status of such browsing copies then has an impact on the issues under consideration in this Study. If the “access” to the protected works by the final user should be understood entirely and only in the framework of the exception for temporary acts of reproduction (possibly by some “twist” on the sole purpose of a “lawful use”), then such use can be considered fully harmonised under the InfoSoc Directive and declared “lawful” in all Member States.

If the UK High Court and the Court of appeal have come to a correct judgment of the issue in *Meltwater*, then each reproduction that enables the end-user to access a work should be considered a restricted act and therefore be authorised by the right holder or exempted by a national exception (e.g. for private use). In this event, the issue of the reproduction at the final user’s end arises not only in case a work is offered to the public for download, but also when it is offered for “mere access”, including the often cited case of browsing or streaming. In practice, it should then be verified, at the user’s end, whether the right holder has given her consent or, alternatively, the national legislation contains an exception covering such use (considering the non-compulsory list of exceptions in art. 5(2) and 5(3) InfoSoc Dir<sup>319</sup>). As will be demonstrated in the following sections, such an interpretation of the reproduction right may undermine the understanding (and localisation) of the making available right.

### **b) Application of the reproduction right to “making available” processes**

The rights of reproduction and communication to the public (including the making available right) are autonomous rights. By consequence these rights can be exercised independently, whenever a material act meets the conditions for protection<sup>320</sup>.

Both rights may apply cumulatively to the same act: an act of upload (resulting in the accessibility of a work to a “public”) may be qualified as an act of making available to the public and may result, in addition, in acts of reproduction. Also, the circumstance that a work is made available with the author’s consent does not entail that the copies directly transferred at the individual demand of the final user are covered by this consent or are otherwise exempted. Different exceptions apply to the reproduction right and the right of communication to the public, including the making available right<sup>321</sup>.

---

318 According to a notice of the UK Intellectual Property Office, the case was referred to the CJEU under case number c-360/13 (accessible via <http://www.ipo.gov.uk/pro-policy/policy-information/ecj/ecj-2013/ecj-2013-c36013.htm>). The following questions were referred :

- (i) an end - user views a web - page without downloading, printing or otherwise setting out to make a copy of it;
- (ii) copies of that web - page are automatically made on screen and in the internet "cache" on the end-user's hard disk;
- (iii) the creation of those copies is indispensable to the technical processes involved in correct and efficient internet browsing;
- (iv) the screen copy remains on screen until the end - user moves away from the relevant web - page, when it is automatically deleted by the normal operation of the computer;
- (v) the cached copy remains in the cache until it is overwritten by other material as the end - user views further web - pages, when it is automatically deleted by the normal operation of the computer; and
- (vi) the copies are retained for no longer than the ordinary processes associated with internet use referred to at (iv) and (v) above continue;

Are such copies (i) temporary, (ii) transient or incidental and (iii) an integral and essential part of the technological process within the meaning of Article 5(1) of Directive 2001/29/EC?

319 The role of the exception for private use is likely to increase, even if it is subject to strict conditions and requires a fair compensation to be paid.

320 This appears *inter alia* from Premier League, in which the display of television broadcasts was assessed as a reproduction and as a communication to the public. It is confirmed more explicitly in the Advocate General's opinion in Pinckney (par. 30).

321 This appears from the structure of art. 5: art. 5(2) lists the exceptions to the reproduction right, art. 5(3) contains the exceptions to all harmonised economic rights.

The fragmentation of the economic rights may complicate this picture. The rights of reproduction and making available to the public may be held by different people and, moreover, the same rights may be exercised by different people in different territories. This complicates both the licensing process and the enforcement of rights.

The reproduction right intervenes in several respects, when a work is made available to the public. Based on the preceding description of the scope of the reproduction right, it seems that a reproduction can be found whenever a copy in the material sense is made. These reproductions may then be exempted under the exception for temporary acts of reproduction (art.5 (1) InfoSoc Dir).

A distinction can be made between the “upstream” and the “downstream” reproductions.

The “**upstream**” reproduction is the copy kept on the hosting server from which the work is available for transmission at the individual demand of the users. This reproduction is most likely a **permanent** or a **temporary** reproduction, which is not exempted under the exception of art. 5(1) InfoSoc Directive. It should be kept in mind that different national rules may apply to localise this reproduction and to identify the person who makes the reproduction. Such copies are also relevant in case of cloud services.

The “**downstream**” reproductions are the copies at the final user’s end, at whose individual request the work is transferred. Some downstream reproductions are intended to be kept for an indefinite period and in that sense **permanent** (e.g. downloaded music tracks for repeated and indefinite listening, a copyright work in an email). These reproductions require the author’s authorisation, unless these are covered under a national exception.

The status of the **temporary** reproductions that enable access to a work may be more **uncertain**, especially if the user has some degree of control over the copy (in which case it is not certain that the copy’s sole purpose is the “mere access” to the work). Given the outcome of the *Meltwater* case before the UK courts and the lack of clear guidance in the CJEU’s decisions (*Infopaq* and *Premier League*) until the CJEU’s ruling in *Meltwater*, this uncertainty affects the copyright status of certain uses, which *de facto* serve only to access the work and may be perceived as “consumptive” and therefore not restricted.

Leaving aside national exceptions, it should be taken into account that downstream reproductions are made in any case. Some are permanent reproductions, others are transient and still others are temporary (but not transient).

It should be remembered that the rules to determine who makes this reproduction and is responsible for the infringement are not harmonised. The person who copies the work may be the final user in some Member States or the service provider in other Member States. By consequence the burden of acquiring the author’s consent or meeting the (national) exceptions may be on different actors.

Another take on the cumulative application can be found with RICOLFI<sup>322</sup>. In his opinion, the right of communication to the public and making content available should not cover the preliminary acts of reproduction that are technically necessary for the content to be transmitted online from one point to the other. Preliminary acts like (i) reproductions of works in ‘packets’ made by telecommunication operators through their networks and (ii) reproductions made by content providers to the end-user (if not exempted as transient reproductions<sup>323</sup>) should be only be protected under the reproduction right. However, these acts of reproductions are lawful in so far as the online transmission of the digitally reproduced content is also (i.e., separately) authorized by the copyright owner through the exercise of the right of communication to the public.

---

322 M. RICOLFI, ‘Comunicazione al pubblico e distribuzione’, *Annali Italiani Diritto Autore (AIDA)*, 2002, 53.

323 Art. 68-bis of the Italian Copyright Act, which transposed into Italian law Art. 5(1) of the 2001 Information Society Directive.



### c) Conclusions on the accumulation of the making available to the public right and the reproduction right

In this Study we have been asked to examine the making available right. We have established that there is no certainty with regard to the constitutive elements of the making available right. A work could thus be hosted (“available”) on a server in one Member State, directed at the public of another Member State (or even several Member States) and transmitted to any other Member State.

In addition to this plurality of acts and locations of any act of making available to the public, the reproduction right should be complied with. The reproduction right is currently understood in a technical way, which means in practice that a reproduction in the technical sense, a “copy”, is equated to a reproduction in the legal sense. The scope of protection of this economic right is limited by the mandatory exception for temporary acts of reproduction (art. 5(1) InfoSoc Dir). The Court of Justice has issued several decisions on the reproduction right and this exception, both harmonised in the Information Society Directive. The overall scope of protection of the reproduction right is still uncertain, especially in the light of non-permanent copies at the end-user’s end (e.g. streaming or browsing). The CJEU will probably clarify this issue when it rules in the *Meltwater* case.

Reproductions have been identified “upstream” and “downstream” in the average online on-demand use, i.e. on the server where the work is hosted for transmission and at the user’s end, after transmission on demand (leaving aside copies in the course of the transmission via a network).

The reproduction right being applied cumulatively to the same processes as the making available right, an additional burden may be imposed upon the person who wants to clear the relevant rights to offer a service (the reproduction right and the making available right as a species of the right of communication to the public are not necessarily held by the same persons). Also, it may increase the number of interested parties in case of an infringement.

Moreover, the reproductions may take place in yet more Member States. The criteria for localising the reproduction have not been harmonised. This leads, at least in theory, to an unpredictable status for online available works. The location of the **upstream reproduction** may or may not coincide with the Member State where the work is made available. The **downstream reproductions** may take place in the Member State where the relevant acts of making available are found. However, it is also likely that reproductions are made outside these Member States. If the making available right is understood in a more narrow way than the accessibility of the work, then still an act of reproduction will be found when the user actually receives and accesses the work. Some temporary copies for viewing a work will be exempted but more permanent reproductions will require the author’s consent, wherever the act of reproduction is performed and even outside the territorial scope of the making available right.

It depends then on the national legislation of the Member States whether such reproduction is restricted or exempted (under a national exception) and who has the burden of this reproduction (acquisition of licences resp. meeting the conditions of the exceptions under national law).

### D. Bottlenecks

In this section the bottlenecks resulting from the application of the making available right will be identified.

The principle that the national legislator is competent to regulate the events occurring on the national territory in copyright terms is not challenged, but several international and European initiatives have been taken to harmonise copyright protection. The absence of a EU definition of the making available right leaves the Member States a considerable margin to interpret this restricted act under national copyright law (until the CJEU fills in this gap) and to identify the relevant elements taking place on their territories.

The CJEU’s decisions confirm the territoriality principle in copyright. The Court has not ruled on the making available right or how this protected act should be localised. It has applied several criteria were applied to localise copyright protected acts on the territories of the Member States. In *Lagardère*, the

location of the (terrestrial) broadcasts was established according to the location of the broadcasting stations, while in *Premier League* the satellite broadcast was found to take place in the Member State where the broadcast originated. In both cases the remuneration had to be calculated in function of the actual and potential audience, which in *Lagardère* could be found in the same Member State as the terrestrial broadcast and in *Premier League* in any Member State where the satellite broadcast could be received. In *Donner* the act of distribution to the public was held to take place in the Member State where the trader specifically targeted the public of the state of destination. In *Sportradar*, the Court found that the act of reutilisation of a database (via the Internet) took place – at least – in the Member State where the public was targeted.

The absence of a definition of the making available right creates **legal uncertainties** as to the territorial reach of the online accessibility of a protected subject matter<sup>324</sup>. Different elements of this complex act could be considered relevant to establish an act relevant under the making available right: the availability on a server, the targeting of a public or the transmission to a Member State, even accessibility of the work has not explicitly be ruled out as a relevant element for the making available right. By consequence, if all Member States are free to determine which element of the complex act is relevant to establish an act of making available, then each could subject this constitutive part to the prior authorisation of the author (and to the corresponding payment of a licence fee – cf. *Premier League*, par. 110). The Member States could define the same or different criteria to apply their national making available right. At least in theory, this would lead to a multitude of acts in a multitude of Member States.

Without a clarification of this restricted act, its relation to the other exclusive economic rights and the localisation criterion, the impact of the territorial application of national copyright laws remains speculative.

#### **Licences and transfer of the making available right by contract.**

**Conflict of laws.** If a cross-border on demand offer is analysed as consisting of constitutive elements of a complex process, each taking place in different Member States, then the rights for each relevant act must be cleared by the service provider or the user. Whenever the situation presents a “foreign” element, it should be determined which law applies to the contract according to the principles defined in the Regulation Rome I.

**Authorship and initial ownership.** The lack of harmonisation and divergence of national rules may lead, in theory, to conflicts between different persons (individuals or legal entities) who are considered authors or initial owners of the copyright under different national laws. If there is a multitude of acts in several Member States at the same time for each material act of upload leading to public accessibility, this means that on the one hand the consent of several persons in different Member States is required and on the other hand that several people have a title to enforce their right of making available in case of infringement. That situation is the one the French Cour de cassation treated in its ruling delivered on 10 April 2013, deciding to refer to the *lex loci protectionis*.

**Fragmented ownership.** The exclusive rights under copyright can be transferred or licensed on a territorial basis. Different people then hold the rights of making available to a particular work for a certain territory. This is mainly an issue for music works and related performances, where the management of the public performance rights (which may include the making available right) has been entrusted to collecting societies. The challenges of new technologies and multi-territorial exploitations have been

---

324 See also L. BENTLY & B. SHERMAN, *Intellectual Property Law*, Oxford University Press, 2009, 151. These authors describe the difficulty of localising an act of making available and consider that this could be done 1) where an individual uploads a work to on to web site; 2) where the server that permits access is located; 3) where the work is accessed or can be accessed or 4) where the public at which the work is targeted is located. Without taking a position, these authors feel that this difficult issue will need to be resolved.

taken on in different ways<sup>325</sup>. Broadly speaking, collecting societies have been working together to offer licences for online use, according to different parameters.

One option is to organise licensing in function of the establishment of the licensee: the collecting society operating in the territory where the licensee has her establishment grants a multi-territorial licences for the repertoire of all collecting societies (not just its own repertoire).

Another option is take the use of the work as the focal point: a collecting society can grant a licence for the use on the territory where it operates for the repertoire of its members and those of other collecting societies, regardless of where the licensee is established. In this latter case, where the location of the use determines which collecting society should grant a licence, the uncertainty as to the material and territorial reach of the making available right may complicate matters. Whenever a relevant act takes place on the territory of another Member State, it may be necessary to involve another collecting society, exercising the rights for that territory.

The challenges of multi-territorial licensing of online rights in musical rights by collecting societies are however dealt with in the proposal for a directive on collective rights management and multi-territorial licensing of rights in musical works for online uses<sup>326</sup>. In any case, the territorial definition of the licensed rights poses less of a challenge when the making available right is held by one party and licensed directly by her, without the intermediary of a collecting society (or competing collecting societies).

**Reproduction right.** The cumulative application of the making available right and the reproduction right may complicate the licensing of works for online use. Each act of making available entails (in the current state of technology and law) several reproductions. The rights should be cleared both “upstream” (hosting server) and downstream (e.g. at the end-user’s side) of the online availability. These reproductions may take place in yet other Member States than the relevant acts pertaining to the making available of the work. Since the reproduction right is autonomous and independent from the right of making the work available to the public, it may be held by a different person. The licensing may present an additional challenge in that case<sup>327</sup>. Furthermore the burden for clearing the rights may be distributed differently in the Member States (end-user v service providers).

This has consequences for different actors involved. The owner of the reproduction right may be another person than the person holding the making available right: both parties may exercise their rights independently from each other (i.e. granting or refusing a licence, determining the licence fee or other conditions). The service provider must clear the rights for the making available of a work and the reproductions that occur during the same technical process. Moreover, it should be determined who has the responsibility, under the applicable national law, to clear the reproduction rights for the copies of the work at the end-user’s end. Even if the end-user has acquired access to a work via a “legitimate” platform, she may face insecurity as to whether the platform has cleared the rights for the reproductions the end-user makes of the work.

### **Infringement.**

**Conflict of laws.** The issues of private international law, and especially the questions of jurisdiction, are solved on the basis of factual elements. Moreover, we assume that the principles laid down by the Court of justice in the interpretation of article 5.3 of the Regulation *Brussel I* can be applied to the making

---

325 See Commission decision of 16 July 2008, C(2008) 3435 final and General Court 12 April 2013, case T-422/08, CISAC v European Commission.

326 Proposal for a Directive of the European Parliament and of the Council on collective management of copyright and related rights and multi-territorial licensing of rights in musical works for online uses in the internal market, COM(2012) 372 final, 2012/0180 (COD), 11 July 2012, accessible via [http://ec.europa.eu/internal\\_market/copyright/docs/management/com-2012-3722\\_en.pdf](http://ec.europa.eu/internal_market/copyright/docs/management/com-2012-3722_en.pdf). The effect of this proposal has not been examined, as this was out of the scope of this study.

327 The licensing of the reproduction right in relation to an online use of a musical work may be dealt with under the proposed directive. This aspect is not examined in this study.

available rights. This might be clarified soon if the Court answers the prejudicial issues referred by the French Cour de cassation in *Pinckney*.

The right holder can choose where to bring her legal action, depending on her objectives. Provisional measures can be obtained in all Member States, regardless of which court is competent on the merits, provided that there is some connection to the territory of that State. It is uncertain whether the CJEU's ruling in *Solvay v Honeywell* (a patent case) can be extended to the making available right and courts can issue cross-border provisional measures. On the merits the right holder can claim reparation of her entire damage in the Member State where the defendant has her domicile or where the event giving rise to the harm occurred. This court will have to apply the *lex loci protectionis* to the infringement the making available right, which means that it may be led to apply the laws of different Member States (the *lex loci protectionis* being the law of the countries for which damages are claimed). The right holder can also act in other Member States where she has suffered prejudice, but the courts of those Member States will be competent only to rule on the damage occurring on the territory of their own Member States, in accordance with their own national law (the *lex loci protectionis* being the law of the Member State for which damages are claimed) or with the law of the country (the *lex loci protectionis* being the law of the Member State where the event giving rise to the harm occurred).

Cessation measures on the merits can be claimed before the courts that have jurisdiction, i.e. where the defendant has her establishment, where the harmful event occurs or where the damage is felt. Where an action is initiated against the infringer (rather than an intermediary), competent courts are found in the Member State where the defendant has her domicile or where the harmful event (act of upload) has taken place. Where an intermediary is asked to put an end to the infringement, the case can be brought before the courts of the Member State where it has its establishment or where the measure is meant to have effect. In case of the Pirate Bay, the operators of The Pirate Bay in Sweden have been criminally convicted; rarely have the users of the platform been addressed (inefficient); instead, the internet access providers have been addressed to block access to the Pirate Bay<sup>328</sup>. It seems that this circumstance is not so much related to the territoriality of copyright and the national character of the making available right but rather the nature of the infringement; where the decision against the service operator cannot be enforced and the individual users cannot be pursued for efficiency reasons or for the public image of the right holders, then the right holder turn to the ISPs, which are organised at the national level.

The applicable law is the *lex loci protectionis*. Except in the Google cases (where fair use is at stake), the applicable law between European countries does not seem to have been a discussion. In the Google cases, the judges determined the law applicable in function of the connecting factors between the dispute and the legislation they decided to apply. A clarification about the definition and localisation of the making available right might nevertheless facilitate the identification of the connecting factors. Although the enforcement of intellectual right has been harmonised, it cannot be excluded that differences remain (e.g. level of damages).

**Authorship/ownership.** As the rules on authorship differ at the European level from one Member State to the other, one material act of making available may infringe the rights of different parties, depending on the territory for which the protection is claimed. Consequently, the claimants might differ from one Member State to the other.

**Reproduction right.** An infringement of the making available right often goes together with an infringement of the reproduction right. Given the autonomy of both rights, it should however be verified for each case whether an act of reproduction is performed, whether this act required the right holder's consent or if an exception applies to the act of reproduction. Furthermore it should be verified where the act of reproduction takes place and who can be held responsible for the infringement under national law. Depending on the (territorial and material) fragmentation of rights, the persons who can claim infringement of the making available right and the reproduction right may not be the same. An

---

328 Belgium : Antwerpen 26 september 2011 AM 2012, afl. 2-3, 216; ICIP 2011, afl. 5-6, 731; RABG 2011, afl. 18, 1269, note P. VAN EECKE, A. FIERENS.

infringement of each right must be established (in accordance with national law), damages may be awarded or other enforcement may be taken.

For the right holders, the independence of the making available and the reproduction rights means that they have an additional legal ground to demonstrate an infringement in case of unauthorised use. Where the rights are held by different persons, it should be verified whether the unauthorised use under consideration entails both acts of making available and reproduction and if the right claimant is involved in the litigation. The (alleged) infringer may thus have to face several right holders, claiming infringements and demanding measures (including cessation and cumulative damages).

## II. Localisation of the act of making available to the public: alternatives

In the first part we have examined the current notion (“status quo”) of the making available right, as a part of the right of communication to the public, as harmonised in the Information Society Directive of 2001. We have found that the making available right is not clearly defined and that the criteria to localise the protected acts have not been explicitly stated. The online exploitation of a work could be qualified as a multitude of restricted acts in a multitude of Member States. We have concluded that these uncertainties could affect the licensing process and the enforcement of the making available right.

In the second part of the Study, we will examine whether acts of making available can be localised within the European Union according to alternative criteria. This examination starts by a reflection on the notion of the making available right (*sub A*). Then, the alternative criteria for localisation will be developed and their consequences will be examined (*sub B* and *C*). Two possible approaches to the making available right are suggested. Under the first approach, the making available to the public is defined in such a way that it can be localised in one Member State (even though its effects are felt in other Member States). This comes down to what could be called a “country of origin” approach, comparable to the system in the SatCab Directive. Under the second approach, the making available right will be defined as an act of exploitation under a certain form and it will be localised in the Member States where the exploitation of the work is taking place.

On a preliminary note, two observations should be made in relation to any legal initiative on the definition of the exclusive right and its localisation within the European Union.

Firstly the **objectives of any legislative intervention** should be clearly stated. Failing a detailed description of the expectations of such intervention it is impossible to assess whether it is desirable to adopt either proposed definition and its localisation criterion. Furthermore, this is necessary to achieve a balance between the interests at stake (authors, right holders, commercial users, end-users, the general public). Since no policy objectives nor a statement of practical problems were communicated to the authors of this Study, we have not formulated any recommendations nor expressed a preference for any hypothesis (including keeping the status quo).

Secondly, any legal initiative should take into account that the making available right is considered a **species of the right of communication to the public**. It should be avoided that the making available right is given features that are in contradiction with the characteristics of the right of communication to the public. Furthermore, the making available right should be compatible with the reproduction right, as it is now known.

Our reflection on alternative interpretations of the making available right will start with the definition of the making available right. We have found four definitions, two of which will be examined in depth and tied to a localisation criterion that allows an integrated approach.

### A. Reflection on the notion of “making available to the public” per se

The making available right protects a complex act, consisting of different constitutive acts. Since such acts are not bound by any territorial restrictions, the act of making available could be localised in several

Member States, which leads to complications in the licensing process and the enforcement of this exclusive right. If clarity on the territorial scope of the restricted act is the objective, then the first step should be to delineate the restricted act itself: determine which constitutive acts are or are not part of the act of making available to the public.

We will start with some preliminary observations before listing the potential approaches to the making available right.

## 1. Preliminary observations

In order to focus the reflection on the definition of the making available right, we will start from two observations. Firstly, the making available right is supposed to cover the use of a copyright work (or other protected subject matter) based on a certain technical scheme. We will draw this technical scheme *sub a*). Secondly, the making available right supposes a “public”. We have described this notion in part I and this description is sufficient for the purposes of this Study.

### a) Technical scheme

The technical scheme can be represented as follows:

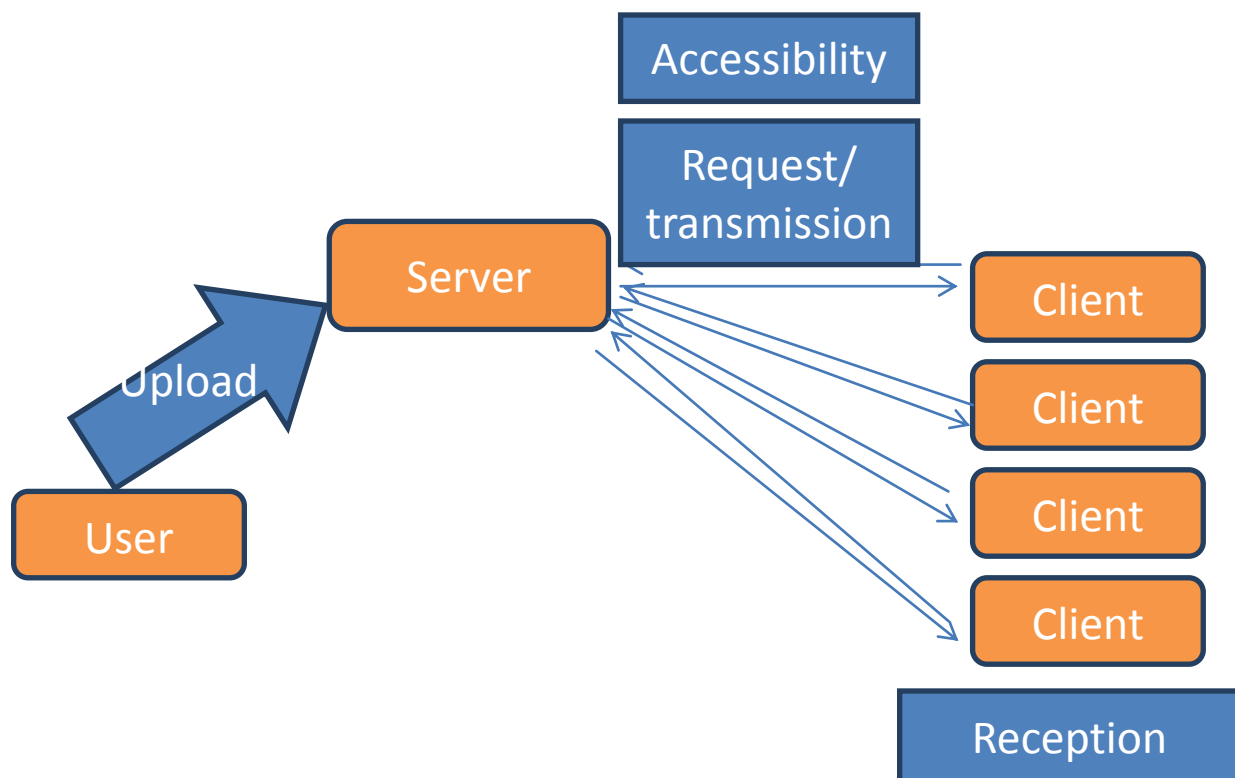

In this general scheme, a user uploads a work to a server. This could be a professional, commercial user (e.g. the owner of an online music store) or a private user (e.g. a hobby blogger or the user of a peer-to-peer file sharing service). The work is then stored on a “server”. The work is accessible “on demand”,

through the (technical) requests of the “client” which are responded by the transmission of the work by the “server” to the “client”. The definitions we will discuss in this Study will refer to the material acts of “upload”, “accessibility” and “reception”.

This technical scheme will serve as the factual basis for the further reflection on the definition of the making available right and its localisation. It could however be applied to different technical and commercial environments: protected works can be made available “on demand” e.g. via the Web or via digital television networks. The business models may be different but the technical scheme remains the same.

## b) Presence of a “public”

Only if a “public” has access to the work, the act of making it available is protected under copyright. We have examined this notion in part I of this Study.

With the increased use of “cloud” services, this condition should be emphasised: these services can indeed be used by individuals for their personal use, to share a work with some people or with a large (or even unlimited) group of people. The user can adjust the technical parameters to her purposes, so the technology by itself should not be decisive to assess whether the making available right has been infringed.

Where the work is accessible only to the user who has uploaded the work to the server, no act of making available to the public is performed, since the work is not available to a “public” (such service enables the user e.g. to continue working on one document, accessible from home, the office or any other location without locally stored copies of the document)<sup>329</sup>. Similarly, a work that will only be transmitted to the members of a group of people who cannot be qualified as a “public”, no restricted act of making the work available to a public is performed. The person or group of people authorised to access (i.e. request access and transmission of the work upon request) the works stored “in the cloud” determines whether the work is available to the “public”. As long as the group of people having access is not qualified as a “public”, no restricted act of making the work available to the public has taken place. It depends therefore on the concrete use of “cloud” services whether or not any protected works are made available to the “public”.

Although the notion of “public” justifies an in-depth analysis, such research goes beyond the scope of this Study. Suffice to emphasise, for the further reflection on the making available right, that a “public” should be present, interpreted in conformity with the decisions of the CJEU so far.

## 2. Alternative definitions

It has been found that this making available right has not been defined and that its scope is not entirely clear. Making a work available on demand is a complex act, consisting of distinct constitutive material acts but at the same time forming a whole (due to the logic of the technical architecture they are part of). More practically: it is uncertain which *material acts* are restricted under the making available right and how the *legal act* of making a work available relates to the *exploitation* of the work. Here we will examine the relation between the legal notion of making available to the public, the material acts covered, the technology and the exploitation of the work.

---

329 A. SCHNEIDER, “OLG Hamburg: Die Rapidshare-Entscheidung, ein Meilenstein?”, Telemedicus, 29 March 2012, retrieved via <http://tlmd.in/a/2229>. Press communication “Urheberrechtswidrige Downloads: Oberlandesgericht Hamburg entscheidet über Prüf- und Handlungspflichten des Online-Speicher-Dienstes „RapidShare“, 15 March 2012, <http://justiz.hamburg.de/presseerklarungen/3334434/pressemeldung-2012-03-15-olg.html> in relation to the OLG Hamburg's decision of 14 March 2012, Az. 5 U 87/09. See on the online personal video recorders: BGH 22 April 2009, I ZE 175/07, “Save.tv”; BGH, 22 April 2009, I ZR 216/06, “Shift.tv”, via [www.juris.bundesgerichtshof.de](http://www.juris.bundesgerichtshof.de). See also S. VON LEWINSKI, “Recent developments of German Authors’ Rights Law”, 164-165.

In this section we will try to come to a better understanding of the making available right by considering different descriptions, each emphasising different elements of the act. A legal definition of the making available right could be formulated along the lines of 4 scenarios. In these four scenarios, three material acts related to the on demand use of works are presented in different combinations (cf. also the technical scheme):

- Upload: the material act of storing a work on a server to which a “public” has access.
- Accessibility: the fact that a member of the public has the possibility to request transmission, upon which the work is transmitted to the client computer of this person.
- Transmission: after the member of the public has requested access to a work, it is transmitted to her device.
- Reception: the material act of receiving a work on the client computer (e.g. in the RAM of the computer). After the reception of a work, other restricted acts may be performed, which may be qualified as a reproduction or a communication to the public.

A definition will clarify which material acts require a (distinct) authorisation of the right holder. The material scope of protection depends on whether the constitutive elements are *cumulative* or *alternative*. For each of the four scenarios identified, we will discuss how the making available right (legal notion) relates to the material/technical acts, the accessibility and the exploitation of the work. We will also discuss the consequences for licensing practices and infringements. Where helpful we will illustrate the different scenarios with examples and where useful we will describe situations involving different countries.

### a) Scenario 1: material act of upload

In the first scenario the legal notion of making a work available corresponds to the straightforward act of uploading a work to a server that is accessible to a “public”. The material acts of upload and accessibility are cumulatively (not alternatively) required in order to find an act of making the work available to the public. It is not required that the work be actually accessed or transmitted to a user’s device.

This interpretation responds to the understanding that whenever a work is distributed via the Internet, it will – by default – be accessible wherever in the world. Unless the uploader implements geographical restrictions, the work can be requested and transmitted to any user (downloader) with an internet connection. In this respect this interpretation corresponds to the **technical reality**, since one act of making available will cover all the technical acts that are connected through one technical logic or architecture, regardless of all geographical borders. This uploader could be a blogger, a user of peer-to-peer file sharing software, a member of a social networking site or a commercial provider of an online music store: the works are made available through one material act of upload.

This definition does not necessarily correspond to the **exploitation** of the work: the uploader (whether a commercial entity or not) may perform one act of exploitation – or more. For example, the user of a peer-to-peer platform makes the works available via the same platform (same language, same terms of use), regardless of where the downloaders are located.

The act of making a work available focuses on the material act of upload (assuming that a “public” has access to the work), rather than the public. It does not suffice that a work is **accessible** to find a separate infringement: the work may be accessed from anywhere in the world, an act of making available is found only if a distinct act of upload is established. It is not self-evident in which country the upload would take place: it could be located in the country where the uploader is established, where the server to which the works are uploaded is situated (if this is known at all) or even another country. How to determine the country where the work is made available to the public could however be clarified in an explicit rule.

**Consequences.** A material act of upload that makes the work accessible to a public leads to one act of making available to the public. It matters not how this “public” is constituted, how it is composed (general public, one target group or several target groups). By default, the work is thus available to an EU-wide public.



**Authorisation.** The act of upload with resulting public accessibility corresponds to one act of making available to the public. The uploader should then acquire the consent of the author for this one act of making available to the public. By default the “public” is an EU-wide one, regardless of where it is located or how it is targeted. If the right holder or the uploader intends to restrict the public, this should be specified by contract.

This does not mean that the author cannot negotiate a remuneration taking into account the entire public, wherever it is located<sup>330</sup>. A remuneration can indeed be calculated in function of the value and therefore the public targeted or reached.

**Infringement.** When the work is uploaded without the author’s consent, the infringement of the making available right is established (leaving aside other defences). No additional infringements are found in the Member States where the work is merely accessible, nor where the public is targeted. Such determination has consequences in terms of private international law, i.e. to establish international jurisdiction and the applicable law. This in turn will have consequences in terms of damages and available injunctive measures.

Under this interpretation one complex technical act, is protected as one restricted act of making available, with extra-territorial effects.

### **b) Scenario 2: accessibility**

In this scenario the making available right protects each of the technical facts related to online availability as distinct acts of making available to the public. The upload and the fact that the work is accessible are constitutive elements of the making available right, each one sufficing to find an infringement.

The mere accessibility of a work is sufficient to find an act of making available, even considered in isolation from the material act of rendering the work accessible or the exploitation of the work. This means that the author’s consent is required wherever the work is accessible, even if the public was not targeted.

From a legal point of view the **technical process** of making the work on demand available is no longer considered as a complex whole, but it is severed according to its technical phases of upload (to a public) and accessibility – each of which can be considered distinct acts of making available to the public. It matters not whether a public is targeted or if the accessibility is “spillover”. The reception of the work, by contrast, is left out of the scope of the restricted act. In other words, one technically complex act results in several legal acts of making available to the public, since each of constitutive parts of the complex technical acts can be qualified as distinct acts of making available to the public<sup>331</sup>. Similarly, one act of **exploitation** can result in several distinct acts of making available to the public.

**Consequences.** A material act of upload that makes the work accessible to a public may result in several acts of making available to the public. The upload of the work (to the extent a “public” indeed has access to it) is a restricted act. The fact of the accessibility is sufficient to find an infringement, regardless of the upload or the targeted public.

**Authorisation.** The uploader needs to clear the rights for the act of uploading the work so the public can access it. She will however also need to define the targeted public and take into consideration the public that is not targeted but nevertheless has access to the work. Even so-called “spill-over” access could lead to an infringement if it is not covered by the author’s consent. Consequently, a fee may be due for

---

330 See by analogy SatCab Directive, rec. 17; Premier League, par. 112.

331 The Advocate-general in Sportradar seems to interpret the reutilization of online databases in this sense.

the mere accessibility of the work – although the remuneration will arguably be lower if there is little interest of an actual or potential public reached<sup>332</sup>.

The uploader should make sure that the boundaries of the licence are reflected in the technical accessibility. Especially where a certain public is targeted, the uploader should technically restrict access to the work to exclude all risk of liability for infringement for the spill over.

**Infringement.** In case one of the constitutive elements is not covered by a licence of the right holder, an infringement of the making available right can be found. The single material act of uploading may then result in a wide range of acts of making available. The constitutive elements also determine the territorial scope of the making available right, so separate infringements can be found in different Member States if these elements take place in different Member States.

This has consequences in terms of enforcement of the making available right in different Member States, but also in terms of conflicts of laws. In a transnational situation, infringements may be found in several Member States, each of which will have to apply its conflict of law rules to determine its competence and the law applicable to the establish the existence of the infringement, to award damages or other measures.

This scenario was assumed to be the status quo of the making available right in the terms of reference of this Study.

### c) Scenario 3: exploitation

A third way of understanding the making available right is by focusing on the exploitation of the work. Under this interpretation, the uploader's efforts to bring the work to the attention of the public will be decisive. This act is a complex act, in the sense that the act of making available starts at the upload of the work and ends with the defining of the public to whom the work is available. The fact that a work is **accessible** is by itself not sufficient for finding an act of making available to the public (spill-over): a more far-reaching intervention is required, in particular the *presentation* of the works in order to reach a certain public. This definition is centred on the public: the exploitation is realised by addressing a public. The material act of upload is per se not relevant for the making available right: it is a technical prerequisite but has no legal significance as such.

This understanding of the making available right is close to some notions of recent decisions of the CJEU, in which it has discarded the mere accessibility of a work or a service and focused on the "targeted public" instead (cf. *supra* in *Donner, Sportradar*). It takes into account that the uploader can develop and design her service to reach a certain public and derive an income from this public, e.g. by advertisement or by imposing a fee for access.

Support for this interpretation can also be found in the CJEU rulings in *Rafael Hoteles* and in *Airfield*. In these cases, the Court found an act of communication to the public when a "new public" was addressed in comparison to a preceding communication, i.e. if it expands the circle of persons having access to that communication<sup>333</sup>. In *Airfield*, the Court found that an operator performs a distinct act of satellite broadcasting when it encodes the signals, provides its subscribers with the means to decode the signals and provides an autonomous service addressed to its own subscribers, offering programmes of several broadcasting organisations in bundles as to constitute a new audiovisual product (the provider deciding upon the package)<sup>334</sup>. These criteria, taken together, suggest that the restricted act should be delineated per exploitation of the work. In *TVCatchup*, the provider of an internet streaming site targeted a public that was composed identically to the public of the initially broadcast that was streamed. The Court found

---

332 See by analogy Lagardère, par 54.

333 *Airfield*, par. 77.

334 *Airfield*, par. 81.

that the right holders had authorised the transmission via broadcasting, i.e. a specific technology that is distinct from streaming technology. In this case it was no longer necessary to find a “new” public, it sufficed to find specific means of transmission each addressing a public (TVCatchup, par. 39). The finding of a new act of communication to the public was supported by the profit-making nature of the streaming service.

The Court also repeatedly mentioned that the profit-making nature of the communication is not an essential condition but it is “not irrelevant” (Rafael Hoteles, 44; FAPL, par. 204; TVCatchup, par. 42).

It could be summarised that a work is made available to the public if it is uploaded and presented to a public in a way that makes it possible for the uploader to derive an economic benefit from the public accessing it. This does not mean that the uploader should actually pursue such benefit: it suffices that this form of communication makes it possible to “monetise” the public. Essentially this capacity is found in the targeting of a defined public. The uploader could target a specific public (in geographic terms or by other criteria) or address a general, unspecified public. In case a public is targeted, the fact that the work is accessible to other people than the targeted public will not result in a distinct act of making available to the public. Either way, the “public” addressed is a central element of the making available right. The act of exploitation and the act or acts of making available will be delineated *in concreto*, depending on the circumstances of the case (e.g. type of content, graphic interfaces, presentation of the content, payment systems, targeted publicity,...).

For example, a publisher of a newspaper makes the news available online as well. The publisher has two websites. One website presents the news that would be interesting to the public of one Member State (news content such as politics or events of national importance), in a language that is spoken by this public. One other website addresses a wider public and contains a selection of the articles that could be of interest to an “international” public and that are translated in a more generally understood language (i.e. English). Two acts of making available could be found (e.g. of illustrating photos or the (translated) articles): the publication on the “national” website and the publication on the “international” website. It matters not that the technical infrastructure is the same or that only one material act of upload has taken place, e.g. the photos are hosted on only one server. Inversely, it matters not that the “national” website can be accessed by “nationals” residing abroad: this accessibility alone will not result in a distinct act of making available to the public.

**Consequences.** An act of making available exists when an act of exploitation can be found. The technical reality does not matter (e.g. several uploads to multiple servers). The efforts *in concreto* of the uploader to address the public are relevant to delineate an act of exploitation. Accessibility or “spill over” is not taken into account.

**Authorisation.** The author’s authorisation is required whenever the uploader takes initiatives to target a public and makes the works available to this public. The authorisation should cover the acts from the upload (availability) to the public to which access is granted. The uploader’s intention and efforts to address a general public or a specific public are taken into account to describe the exploitation of the work and to determine whether one or several acts of making available are performed. Whenever an uploader willingly addresses a public, she should acquire the author’s consent. When she distinguishes several publics, e.g. by addressing visitors with a certain profile, she must acquire the consent for each form of exploitation. Logically these circumstances will also have an influence on the modalities of the licence, in particular the licence fee. A more specific audience could lead to a lower fee (if a smaller public generates a smaller revenue) or a higher fee (e.g. for scarce niche content).

**Infringement.** An infringement can be found when the right holders have not authorised the making available of the work (and this use is not exempted by an exception) or if the consent does not cover all aspects of the making available, including the whole of the targeted public. By contrast if the uploader has cleared the making available rights for the intended public but the work is accessible to individuals, who are not part of the targeted public, then no distinct infringement can be found (spill-over). A work distributed via a peer-to-peer platform will find a general public, without any restrictions and without distinction in the presentation or selection of the offered works. It can be assumed that the uploader

willingly addresses the largest possible public. The material availability on a server and the accessibility to a general public are considered infringements. This delineation of the infringement and the absence of a specific public will affect the determination of the competent courts and the applicable law. These rules will determine which court can impose which measures.

By contrast, another outcome will appear if the uploader offers works on demand via more streamlined channels, reaching a selected public or a number of selected publics. The fact of targeting a public entails that the other people who may have access are not part of the intended public. If a distinction is made between different publics and the presentation of the works is adapted to reach a certain public (e.g. front-end in different languages, local advertisement, selection of the catalogue or the content and presentation in function of popularity or recent events), the right holder will be able to demonstrate distinct acts of making available to the public. This will affect the right holders' possibilities of acting before the national courts (competence) and applying national copyright laws. It will also affect the available measures, in particular the calculation of damages.

#### **d) Scenario 4: upload or accessibility or reception**

In the third scenario the right of making available to the public covers the upload to a server, the accessibility of the work by a public and the reception of the work after transmission<sup>335</sup>. It suffices to find one of the three constitutive acts of the process to find an act of making the work available to the public: the constitutive acts are not cumulative but alternative conditions of the making available right. In this hypothesis, it suffices to find that the work is **accessible** to find an infringement. Moreover, the mere fact of the **reception** suffices to conclude that the making available right is infringed.

Traditionally the reception – in private circles – is however not protected under the right of communication to the public. This view is confirmed in the CJEU's ruling in the "Premier League" case<sup>336</sup>. By contrast, the reception (even in private circles) could entail (temporary) reproductions, which should be assessed by the exception for temporary acts of reproduction (art. 5(1) InfoSoc Dir).

After discussion with the Commission, this scenario will not be examined further.

#### **e) Conclusion on the alternative definitions**

Before examining criteria to localise acts of making available within the European Union, it was found necessary to consider a definition of the exclusive right. The definition of the restricted act determines the material reach of the right, which material acts are protected and which are not. The definition of the making available to the public has consequences for its territorial reach. In practice a work made available on a global network will cover several, if not all, countries. In order to come to more precise localisation of the restricted act, it needs to be ascertained which material acts are protected and which are not. Once the protected acts are identified, they can be tied to a particular territory.

Four definitions of the making available right have been proposed.

The first definition emphasises the material act of uploading a work, which will then be accessible to a public. How the public is composed has little importance, the exploitation or the accessibility of the work play no role in this interpretation. One unique act of making available is found in the material upload of a work that is then accessible to a public. This scenario will be examined in further detail in section B.

Under the second scenario, the right of making available covers all stages of the process of on demand availability, from the material act of upload to the accessibility of a work. Only the reception (in private

---

335 A. PEUKERT, "Territoriality and Extraterritoriality in Intellectual Property Law". p. 17. In this sense also J. REINBOTHE & S. VON LEWINSKI, *The WIPO Treaties* 1996, 108.

336 Premier League, par. 171.

circles) of the work is not protected under this right. This scenario was taken as the status quo of the making available right and will not be examined further in this Study.

The third scenario understands the making available right as covering the exploitation of works in the form of on demand availability of the works. This scenario emphasises the concrete efforts of the uploader to present a work to certain public, a general, undefined public or a specific, delineated public. It is understood that by “targeting” a certain public, the uploader has the possibility to generate a commercial benefit of the on demand availability of the work, even if she has no commercial intent. The material act of upload is a necessary precondition of this exploitation, but it is the fact of reaching a public makes it possible to realise a commercial benefit. By contrast the mere accessibility by individuals outside the targeted public will not be considered a constitutive element of the making available right. .

A fourth scenario extends the making available right from the upload to the reception of the work. The mere reception (in private circle) is then considered a constitutive part of the making available of the work, which requires the author’s consent. This scenario will not be examined further in this Study.

In the next part of the Study we will examine which criteria can be applied to localise the act of making available within the European Union.

Firstly, a localisation criterion will be examined that will place the restricted act in one unique Member State. This will be referred to as a “country of origin” criterion, similar to the localisation criterion in the Satellite and Cable Directive. In order to achieve this purpose, ideally the making available right should be defined as a unique act that can be localised in one Member State (as has been done in the SatCab Directive). In order to situate the act of making available in one Member State, it will be understood as a material act of upload, leading to the work being available to the public at the demand of individual member of the public (*supra sub* scenario 1).

Secondly, a localisation criterion based on the exploitation of the work will be examined. This criterion may place the act of making available in one Member State (if the exploitation takes place in one Member State only) or in several – or even all – Member States. The making available right then protects the exploitation of the work in a certain form (i.e. on demand availability) as described under scenario 3.

After having described the localisation criterion and tied it to a certain definition of the making available right, the legal consequences will be considered in terms of conflict of laws, authorship and ownership and accumulation with the reproduction right.

## A. “Country of origin”

In this section, we will analyse how the making available right would be applied in combination with a “country of origin” principle. The starting point is to match a definition of the making available right to a criterion that localises the restricted act in one single Member State (sub 1). Several practical criteria could be considered to localise an act of making available in one single Member State: where the servers are located, where the uploader has her centre of interests or where the material act of upload was performed. Then the effects of such country of origin principle will be considered in terms of authorship and ownership of a work, the cumulative application with the reproduction right and enforcement (sub 2-4). A summary of the findings will be described in the intermediate conclusion (sub 5).

### 1. Principle

One of the central questions in this Study was to examine the implications of a “country of origin” principle<sup>337</sup>. The objective of implementing such principle is to localise the act of making available in one

---

337 See terms of reference, “output 2, part I of the Study :

single Member State. This objective can be achieved by defining the act of making available to the public unambiguously as a simple material act that can be localised in one Member State and by selecting a localisation criterion that situates this act in one Member State.

The material act of upload (provided that it results in the work being available to a *public* on its demand) can be seen as the starting point of making a work available on demand. Such act can be situated in one Member State, even if it may have ramifications in other Member States. The upload of a work to a server is a simple act, which is confined in time and place. Its effects, by contrast, may spread out in time and space: the work may be accessible in several countries and for a longer period. This extended availability would then be considered a corollary of the act of upload, which would be the only relevant act.

A similar construction has been set up in the SatCab Directive. This Directive contains a “country of origin” principle (cf. cons. 18 SatCab Dir) by which satellite broadcasts are located in one single Member State, i.e. the country of “origin”. In order to achieve this localisation in one Member State, the Directive contains a definition of the right of communication to the public by satellite and a localisation criterion. The “communication to the public by satellite” is defined as “*the act of introducing, under the control and responsibility of the broadcasting organization, the programme-carrying signals intended for reception by the public into an uninterrupted chain of communication leading to the satellite and down towards the earth*” (art. 1(2)(a) SatCab Dir). This restricted act is then localised on the territory of a Member State by the criterion in art. 1(2)(b) SatCab Dir, which states that “[*the*] *act of communication to the public by satellite occurs solely in the Member State where, under the control and responsibility of the broadcasting organization, the programme-carrying signals are introduced into an uninterrupted chain of communication leading to the satellite and down towards the earth*”.

The European Commission has observed that this rule designates the application of the law of one Member State instead of several legislations<sup>338</sup>:

Several observations may be made with respect to this construction. Firstly, it was deemed necessary to provide a definition of the restricted act. Such definition allows delineating a process and considering it as one protected act, which is then localised in one Member State. Inversely, it reduces the risk that interested parties put forward one material element to claim a distinct infringement and localise it in another Member State, more convenient to their purpose. Secondly, the definition in the SatCab Directive refers to a material act (“the act of introducing the signals into an uninterrupted chain of

---

Output 2: Examine the implications of the application of the “country of origin” principle (applicable/substantive law) to:

(a) Enforcement measures: identification of specific issues relating to the enforcement of copyright and related rights in the country of destination (damages and injunctive relief; examination of relationship with Regulation 44/2001).

(b) Determinations of authorship: what would be the (legal and economic) consequences of maintaining the status quo (limited harmonisation of this matter, i.e. harmonisation of authorship limited to Article 2(2) of the rental directive) while implementing this principle? Is the harmonisation of authorship necessary or desirable in order to give effect to the country of origin principle? Are there other issues of substantive law that would need to be harmonised (or further harmonised) e.g. exceptions.

(c) Transfer of rights/ownership: what would be the effect of maintaining the status quo (transfer of rights are not harmonised in the Community *acquis*) while implementing the country of origin principle? (Relationship with Regulation 593/2008)

(d) The reproduction right: there will be a need also to examine the link between the application of the “country of origin” and the reproduction right associated with certain acts of making available e.g. downloads.

338 Report from the European Commission on the application of the Council Directive 93/83 EEC on the coordination of certain rules concerning copyright and rights related to copyright applicable to satellite broadcasting and cable retransmission, COM(2002) 430 final, 3.1.1: “The object of the Directive, with the definition of the notion of communication to the public by satellite at Community level, was to put an end to the legal uncertainty regarding the rights to be acquired, by specifying the place where the act of communication occurs and the copyright legislation applicable to contractual relations regarding the transfer of rights. The applicable law is that of the Member State in which the programme-carrying signals are transmitted; its application extends beyond national borders into the Member States in which the signals are received (although, in technological terms, the footprint covers many areas other than those of the Member States, the term “footprint” in this Report refers only to the territory of the Member States). This principle avoids the cumulative application of several national legislations of the various Member States covered by the footprint (recitals 14 and 15)”.

communication”), which marks the starting point of a complex process that may cover several technical acts and therefore take place in different Member States.

It seems that a “country of origin” criterion may well be applied with the right of making available understood as a material act of upload. It is less straightforward to combine a localisation criterion leading to one single Member State with other definitions, especially those emphasising the exploitation or the accessibility of the work.

The act of making available to the public could be understood for example as protecting the corresponding form of exploitation of the work. Such restricted act would be established *inter alia* by proving efforts to target a specific public (by adapting its interface, language, content, events, ads,...). One service could target several (national) publics separately per country, or collectively, for example neighbouring countries that share a language or interest in certain events (such as festivals). In those cases, several acts of exploitation would be established in different Member States, hence as many acts of making available could be established. These distinct acts would however be localised in one Member State (e.g. establishment of the service provider).

Such definition is not completely irreconcilable with a unique localisation criterion but it is not the most intuitive or coherent combination to apply the exploitation definition with a “country of origin” criterion. It is overly complex to establish an act of making available via the exploitation of a work in possibly several Member States, only to localise the restricted act in another Member State. Moreover, in some cases, restricted acts may be found in several Member States – despite the application of “country of origin” principle. It could be imagined that several partners contribute by various means to the exploitation of a work and thus share the responsibility for the exploitation. If the localisation criterion refers for example to the Member State where the person responsible for the making available has its establishment and the partners have their establishments in different Member States, then it restricted acts take place in several Member States and the objective of the “country of origin” criterion would not be met.

For this part of the reflection the making available right will be understood as a simple material act, the act of upload that results in the work being available for a certain period of time, on demand for members of the public who may reside in various Member States. Using this definition, the making available of a work may be localised in one single Member State according to criteria that will be examined in the next section.

### **a) Possible localisation criteria**

Various criteria could be applied to localise this act of making available in one single Member State. It must be borne in mind that only the localisation within the European Union will be examined here, without considering the localisation of acts in an international situation where certain acts take place in third countries.

The act of making a work available to the public could be situated in the Member State (i) where the servers are located on which the works are hosted;(ii) where the uploader has her centre of interests or (iii) where the material act of upload has taken place. These criteria will be developed here. It should be noted that all these criteria are considered indicating a “country of origin” of the making available, in the sense that they localise the restricted act in one Member State, even if this restricted act has effects beyond this Member State (access to and exploitation of the work in other Member States).

#### **(i) Location of the servers on which the works are hosted**

One possible localisation criterion is the location of the server on which the work is hosted. The act of making available takes place in the Member State where the servers are situated.

There are few reasons to choose this criterion and many reasons not to. In simple cases, it will be clear where the works are hosted and where the servers can be found, hence in which Member State the act of making available takes place. However, the location of the hosting servers may not be particularly

significant for the use of the work (cf. “cloud computing” services). It may be difficult to determine in which country the servers are located on which a particular work is hosted<sup>339</sup>. Also the works may be spread over different servers in different countries, meaning that one act of making available would be situated in several countries (no single location). Practically, the uploader may not be aware in which country the works are hosted and by which laws she should abide. Inversely, the uploader may choose the location of the hosting servers exactly in a Member State with relatively weak protection in terms of e.g. tariffs or judicial remedies. This criterion may lead to location-shopping to the detriment of the author and the right holders. Moreover, it is common to use servers located outside the EU: in this case this criterion may have an impact on the effectiveness of the harmonised protection<sup>340</sup>.

As agreed with the Commission, the localisation criterion according to the location of the hosting servers will not be further examined.

**(ii) Centre of activities of the uploader: establishment, domicile or habitual residence**

In this scenario, the act of making available is localised at the uploader’s centre of activities. A legal entity has its centre of activities at its establishment; a natural person has hers at her domicile or habitual residence. All acts of making available performed by either a natural person or a legal entity are connected to the place where this person has her/its centre of activities and take place in that Member State. A blogger who posts a picture to her blog invariably performs an act of making available in the Member State where she has her habitual residence. The provider of a pan-European online music service makes the work available to the public only in the Member State where it has its establishment.

It matters not, under this approach, where the uploader actually was situated when the material act of making available was initiated: the legal act of making available will be situated in the Member State where it/she has its/her establishment or domicile/habitual residence. The blogger makes her photos available in her Member State of domicile, even if she posts them while travelling abroad. The music service provider makes all works available in the Member State of establishment, regardless of the fact that the service is offered throughout Europe and regardless of where the technical operations of upload are performed. The act of making available may thus take place in one Member State, while it may have effect in other Member States in the sense that the works may be accessible or commercialised in other Member States.

The localisation of the restricted act in the Member State where the uploader has her centre of activities has the advantage that this location is relatively easy to determine. Also, it localises the restricted act in one single Member State (possibly after a “cascade” of localisation criteria). This provides legal certainty, especially when the exploitation covers the territory of several Member States without targeting one national public in particular or when several national exploitations are set up of the same catalogue of works under the same (branded) service. It can be expected that the parties will consider the total value of exploitation in their negotiations to determine the licence fee, taking into account the entire public in the Member States where the service gives access to the works. Such parameter could be provided by law (cf. rec. 17 SatCab Directive).

It is self-evident for the uploader to abide by the law of the country where she is established, especially for legal entities with complex (transnational) structures (legal certainty for the uploader and for rights holder). The establishment criterion was also applied in the Satellite and Cable Directive, as an

---

339 Sportradar, par. 45.

340 L’Oréal, par. 63. The Court held that the effectiveness of (national and Community) trademark protection would be undermined if it did not apply to “the use, in an internet offer for sale or advertisement targeted at consumers within the EU, of a sign identical with or similar to a trade mark registered in the EU merely because the third party behind that offer or advertisement is established in a third State, because the server of the internet site used by the third party is located in such a State or because the product that is the subject of the offer or the advertisement is located in a third State”. See also Sportradar, par. 45.



alternative localisation criterion in case the act of communication by satellite does not occur within the territory of the EU (art. 1(2)(d)(ii) SatCab Dir<sup>341</sup>).

Usually the economic activities of the service provider are located on a continuous basis in the Member State of establishment (cf. case law of the CJEU). This means that the service provider will probably organise the exploitation of the work at its establishment and feel economic return of the service there (profits, benefits).

The localisation of the act of making available in the Member State where the uploader has its/her centre of activities presents some disadvantages.

In this section we examine the making available right, defined as the material act of upload. In some cases, the localisation criterion of the centre of activities of the uploader goes well together with this definition, in particular when the material act of upload is performed at the centre of activities of the uploader, for example an individual who distributes a work via a peer-to-peer network from her home.

**Material act of upload v establishment.** In case the material act of upload takes place in a different Member State than where the uploader has its/her centre of activities, the material act is subject to the copyright law of another Member State. A service provider may have a complex, international structure and have its establishment in one Member State (localisation criterion), while the acts of upload (definition) are technically performed in another Member State. An individual may perform acts of upload (definition) while residing in another Member State than where she has her domicile (localisation criterion), e.g. for holidays or during a business trip. The localisation criterion (centre of activities, i.e. establishment or domicile/habitual residence of the service provider/uploader) then has no link with the material acts that defined the act of making available.

For example, an online music service provider has its establishment in country A but has its technical operations performed in country D. The material acts performed in country D would then be subject to the copyright law of country A, thus depriving country D of its power to regulate material acts on its territory.

This could lead to a different treatment to people performing the same act, with the same effect, in the Member State where they do have their centre of activities. A music service offered to the same European public by a service provider established in Member State E would be subject to a different copyright regime than the music service provider established in Member State A, although the service could be virtually the same (catalogue, target audience, business model).

**Exploitation v establishment.** It may lead to a strange effect of localising the making available in a Member State where no effects of the making available are felt. This is the case when a work is made accessible in one Member State only (a purely “national” exploitation), while the uploader has its centre of activities in another Member State. For example, a service provider established in one Member State could offer a service that is only accessible in another Member State and that is protected by geo-blocking measures. The making available of works would be regulated as an act taking place in the Member State where the service provider or uploader is established. In that case, there are no significant links with between the Member State of establishment and the Member State where the work is

---

341 Art. 1(2)(d) “Where an act of communication to the public by satellite occurs in a non-Community State which does not provide the level of protection provided for under Chapter II,

(i) if the programme-carrying signals are transmitted to the satellite from an uplink situation situated in a Member State, that act of communication to the public by satellite shall be deemed to have occurred in that Member State and the rights provided for under Chapter II shall be exercisable against the person operating the uplink station; or

(ii) if there is no use of an uplink station situated in a Member State but a broadcasting organization established in a Member State has commissioned the act of communication to the public by satellite, that act shall be deemed to have occurred in the Member State in which the broadcasting organization has its principal establishment in the Community and the rights provided for under Chapter II shall be exercisable against the broadcasting organization”.

accessible (national exploitation)<sup>342</sup>. Additional measures could mitigate these effects (furthering the redistribution of the revenue among the right holders in different Member States).

For example, a provider of an online music service has its establishment in country A but offers services that are only accessible in countries B or C. In order to offer a legitimate service, the service provider will acquire the consent in its Member State of establishment A, in order to make the music works available in countries B and C. If different people hold exploitation rights in Member States A, B and C (territorial fragmentation), then the right holders in the country of exploitation (B and C) could see their economic rights hollowed out by a legitimate service, authorised by the right holder for the country of establishment (A).

Consequently, if the exclusive rights to a work are territorially fragmented, the exploitation value of rights held by one right holder could be undermined by licences granted by another right holder. A service provider should obtain a licence in the Member State where it has its establishment, even if it intends to offer a service in another Member State (national exploitation). The right holder in the Member State of establishment can thus grant a licence with effect on the territory of other Member States, i.e. where the public will have access to the service. The rights holders in the country of exploitation could see their economic rights hollowed out by a legitimate service located in the country of establishment of the service provider/uploader.

**Location shopping.** Moreover, the uploader could choose to establish its centre of activities in a Member State with relatively weak copyright protection in terms of tariffs or judicial remedies<sup>343</sup> (establishment-shopping)<sup>344</sup>. This criterion would also confer extensive extra-territorial effects in terms of rights acquisition (e.g. extended licences) and limitations to the rights to the extent that authors were not able to determine the territorial scope of the authorisation. Or the service provider may have chosen the country of establishment for reasons not related to copyright (e.g. tax purposes or liberal advertisement rules).

### ***(iii) Geographical location of the material act of upload***

According to this criterion, the act of making available takes place where the material act of upload of the works is initiated. This is the place where the user/uploader is present when she operates the transmission of the protected works to a server, knowing that it will lead to the work being available to a public. A blogger performs an act of upload when she clicks “publish” to upload her latest post to her blog. The act of making available then takes place in the country (Member State) where she is at that time.

The material act of upload is not necessarily performed at the location of residence or establishment of the uploader. When a natural person uploads a work, while residing “abroad”, the restricted act takes place “abroad”, not in the country of domicile or habitual residence. A legal entity with an establishment in one Member State and an operational branch in another Member State performs the acts of making available in the Member State where the actual act of upload is performed. The place of upload is not necessarily the same as the place where the servers are located: a work can be initially uploaded by a user situated in country A and then stored on servers located in country B.

---

342 Cf. CJEU 5 June 1997, Case C-56/96, VT4 Ltd v Vlaamse Gemeenschap.

343 It has not been harmonised how damages should be awarded. Some Member States may provide statutory damages (e.g. Bulgaria – see P. SAMUELSON, P. HILL, T. WHEATLAND “Statutory Damages: A Rarity in Copyright Laws Internationally, But For How Long?”, 60 J. Copyright Soc’y U.S.A. (forthcoming September 2013), already accessible via [http://cyber.law.harvard.edu/people/ffisher/IP/Samuelson\\_SDs\\_2013.pdf](http://cyber.law.harvard.edu/people/ffisher/IP/Samuelson_SDs_2013.pdf)). Other Member State take initiatives to restrict damages imposed upon individuals (see “First-time copyright offenders will get off with a \$200 warning” The Hollywood Reporter, 1 July 2013, via <http://www.hollywoodreporter.com/news/germany-caps-piracy-fines-577989> and via <http://the1709blog.blogspot.be/2013/07/the-copykat-tenenbaum-teutonic-trolls.html>).

344 An exhaustive comparison of overall levels of copyright protection (taking into account the definition of the protected subject matter, the harmonised exclusive rights, the moral rights, applicable exceptions and limitations, contractual protection and enforcement measures has not been performed, this was beyond the scope of this study.

According to this criterion, the act of making a work available to the public will take place in one Member State, even if the work is accessible in several Member States and even if the exploitation of the work is directed to several Member States.

This criterion is consistent with the principle of territoriality, according to which a state can regulate the behaviour of people while they stay on its territory, even if they have their habitual residence or domicile in another Member State.

It is consistent with the approach in the SatCab Directive (definition of the act of satellite broadcasting and localisation according to introduction of the signals in an uninterrupted chain of communication).

This criterion approaches the making available right from the perspective of the uploader, who should abide only by the law of the country where she is present, both professional service providers and natural persons.

This criterion also presents a number of drawbacks.

**Practical application.** The country where the act took place may be difficult to establish (supposing already that the upload takes place within the EU<sup>345</sup>). This may cause an important (administrative) burden for a service provider that uses large volumes of works, e.g. trans-European music service providers or video online services. Such service providers may perform acts of uploads at different locations in different Member States, depending on its organisation (e.g. by distinct operational or technical entities). Its operations will then be governed by several laws, which the service provider should integrate in its organisation. Such criterion would be complex to apply in case of “user platforms”: the platform provider may have concluded an agreement with the right holders for content uploaded by its users – but the same content may be uploaded by users in different Member States so it would be difficult to indicate one location for the upload. This criterion may confront the right holder to difficulties in case of infringement, where the place where the upload took place is not easily established.

**Significance.** The location of upload may not be particularly significant for the use of the work or even to the uploader. Especially in the case of complex organisations, the place where the material act of upload is performed may be determined by technical, organisational or even random criteria.

**Exploitation v upload.** In case of territorial fragmentation of rights, the making available of a work in one Member State may undermine the exploitation of the work in another Member State. If the act of making available is localised in the Member State of upload, then an exploitation licence should be acquired for that Member State. This entails that a service provider should obtain permission to make the work available in the Member State where it performs the act of upload, even if it intends to offer a service to a public in another Member State (national exploitation). If the rights of making available are territorially fragmented, the right holder for the Member State of upload can grant licences with effect in the Member State of exploitation, without any possibility for the right holder in this Member State of exploitation to oppose such licence or to obtain a compensation for such exploitation.

For example, a provider of an online music service performs acts of upload in country A but offers services that are only accessible in countries B or C. In order to offer a legitimate service, the service provider will acquire the consent in the Member State of upload A, in order to make the music works available in countries B and C. If different people hold exploitation rights in Member States A, B and C (territorial fragmentation), then the right holders in the country of exploitation (B and C) could see their economic rights hollowed out by a legitimate service, authorised by the right holder for the country of establishment (A).

---

345 A proper construction should be found for uploads taking place outside the EU. Without such solution, it is likely that many content providers would perform acts of making available outside the EU (in particular the US). However, in this study, only the localisation within the EU is examined.

**Location shopping.** Worse, this criterion entails a vulnerability to location-shopping: the uploaders (especially commercial service providers) may structure their organisation in function of the weakest copyright protection<sup>346</sup>.

**Legal fiction for practical applicability.** Some of these disadvantages may be solved, in particular the practical difficulty of applying the criterion of Member State of upload. The localisation of the act of making available to the public in the Member State where the material act of upload takes place may indeed prove cumbersome to legal entities, with an organisation covering several Member States.

The inconveniences of this criterion may be mitigated by combining it with a legal presumption or a legal fiction. It could be provided that the making available to the public takes place at the location where the material act of upload takes place (i.e. where the person is located when she executes the material act of making available) and that, in the case of legal entities, the act of upload is deemed to take place in the Member State where the legal entity has its establishment. This combination of criteria ensures a flexible solution in that the criterion of the geographical location of the act of upload can be applied both to natural persons and to legal entities.

Such presumption does not diminish the risks inherent to localising a transnational operation in one Member State, in particular “location-shopping” and the potential undermining effect on right holders in case of territorial fragmentation (e.g. territorial exclusivity in function of exploitation windows). The effects on other right holders could be mitigated by requiring a licence fee in function of the total exploitation value and possibly by making the redistribution among right holders mandatory (e.g. via collecting societies). Apart from remuneration issues, the localisation, the right holders in other Member States than the Member State of upload could be affected by an overall lower level of protection (exceptions or licensing mechanisms would find application beyond the nation borders, fewer measures may be available in case of infringement). Given the potential impact of such changes and the complex measures required to mitigate the effects, the policy objectives of adopting a localisation criterion leading to one single Member State must be clearly stated.

## **b) Criteria in other directives and the notion of “establishment”**

Other directives have defined localisation criteria for the behaviour they are regulating. First we will give a brief overview of the various localisation criteria thus operated, then we will examine one of these criteria more in depth, i.e. the notion of establishment.

### **(i) Various criteria**

Several directives regulate online activities that show some similarities to the making available of works to the public. In order to do so, they put forward certain criteria to localise the activity in one Member State, the idea being that the activities or services performed in that Member State are governed by the law of that Member State and controlled by it. The purpose is to create a single area without internal borders. However, the criteria used to localise this “country of origin” vary from one directive to the other. Certain directives use economic criteria (place of establishment) while other directives apply technical criteria (place of the uplink).

Before the further analysis of the notion “establishment”, the localisation criteria can be summarised as follows

- The **Directive on e-commerce** (2000/31/EC) relies to the notion of establishment used in the Treaty on the functioning of the European Union and refers to the case law of the Court of justice

---

346 An exhaustive comparison of overall levels of copyright protection (taking into account the definition of the protected subject matter, the harmonised exclusive rights, the moral rights, applicable exceptions and limitations, contractual protection and enforcement measures has not been performed, this was beyond the scope of this study.

for the interpretation of that criterion. As a consequence, the country of origin of the service provider is the place where the service provider operates the actual pursuit of a genuine economic activity through a fixed establishment for an indefinite period.

- The **AVMS Directive** (2010/13/EU) uses a list of alternative criteria to localize the country of origin of a service provider. The first criterion is the establishment of the service provider. The directive provides an autonomous meaning to that concept and regulates the hypothesis where a service provider is established in several Member States. It also uses alternative criteria, such as the use of a satellite and the notion of establishment in the meaning of the Treaty and it provides a provision preventing circumvention of the establishment criteria.
- The **Directive on the protection of personal data** (95/46/EC) first clarifies technical terms. Then, it localizes the protected act in the country of establishment of the “controller”, defined as the country where the controller operates effective and real exercise of activity through stable arrangements.
- The **Cable and Satellite Directive** (93/83/EEC) also starts with the clarification of various technical terms, including the complex act of “communication to the public by satellite”. Then it localises the protected act in the country where the program-carrying signals are introduced into an uninterrupted chain of communication under the control and responsibility of the broadcasting organization. This directive operates a technical criterion, linked to the responsible broadcasting organisation.
- The **Services Directive** (2006/123/EC) develops the freedom to provide services, starting from the Member State where a service provider has its establishment. This is the actual pursuit of an economic activity by the provider for an indefinite period and through a stable infrastructure from where the business of providing services is actually carried out.

It may be worth reminding that the country of origin principle only applies to acts or services occurring in or having a sufficient link with the European Union. Some directives put forward criteria to link an activity to a Member State, even if the normal criterion would point to a location in a **third country**. For example, the Directive on the protection of personal data provides that the national law of a Member State of the European Union shall apply to the processing of personal data carried out by a controller located in a third country if he makes use of equipment situated on the territory of said Member State (art. 4 Data Protection Directive). Moreover, the Cable and Satellite Directive stipulates that the communication to the public by satellite occurring from a third country takes place in the Member state where the uplink station from where the signals are transmitted is located or, if there is no use of an uplink station, in the Member State where the broadcasting organization that has commissioned the communication to the public by satellite has its principal establishment (art. 2 SatCab Dir). Still, the “country of origin” principle cannot govern all the acts involving third countries. In specific circumstances, the common rules of private international law will still apply and each Member State might apply its national law to the acts having no link with the European Union.

Finally, we find important to remind that several directives have linked the country of origin principle to a **derogation clause** in order to tackle problems coming from a lack of harmonization of the material rules. Such clause allows the Members States to derogate from the country of origin principle and apply their national law in order to protect specific interests (e.g. consumer protection). The derogation mechanism could also be applied to the “country of origin principle” with regard to the making available right to avoid difficulties coming from a lack of harmonisation.

The principles discussed can be summarised in this scheme:

Directive	Localisation	Interpretation	Enforcement towards service providers located in non-EU countries
Directive on electronic commerce (2000/31/EC)	Member State of establishment of the service provider	Place of the actual pursuit of an economic activity through a fixed establishment in that State for an indefinite period	Does not apply towards service providers located in third countries
Audiovisual Media Services Directive (2010/13/EU)	Member State having jurisdiction to regulate the provider	<ol style="list-style-type: none"> <li>1. Member State of establishment of the provider in the sense of art. 2, §3 of the Directive</li> <li>2. Location of the satellite uplink or the satellite facilities</li> <li>3. Member State of establishment in the sense of the Treaty</li> </ol>	Does not apply to audiovisual media services intended exclusively for reception in third countries and which are not received with standard consumer equipment directly or indirectly by the public in the European Union
Directive on the protection of personal data (Directive 95/46/EC)	Member State of establishment of the controller	Place of an effective and real exercise of activity through stable arrangements	Member state where the controller makes use of equipment, automated or otherwise, unless such equipment is used only for purposes of transit through the territory of the Community
Directive Cable and Satellite (93/83/EEC)	Member State where the program-carrying signals are introduced into an uninterrupted chain of communication	In practice this will often be where the broadcasting organisation has its establishment.	<ol style="list-style-type: none"> <li>1. Member State where the uplink station from where the signals are transmitted is located</li> <li>2. Member State where the broadcasting organization that has commissioned the communication to the public by satellite has its principal establishment</li> </ol>
Services Directive (2006/123/EC)	Freedom to provide services in other Member States than where the service provider is established.	Place of "actual pursuit of an economic activity by the provider for an indefinite period and through a stable infrastructure from where the business of providing services is actually carried out" (art. 4)	/

**(ii) The notion of “establishment” and its location**

The country of establishment is used as the “country of origin” in four directives (this is the case in the E-Commerce, AVMS, Data Protection and Services Directives<sup>347</sup>). However, the notion of country of “establishment” finds its specific application for each directive. We will examine how these four instruments define the place of establishment of the “service provider”. It should be noted at the outset that the criterion of “establishment” applies to legal entities, rather than to individuals.

- **E-Commerce Directive**

The E-Commerce Directive takes the “establishment” of the service provider as the criterion to localise the service and thus determine which laws should be observed (“country of origin” – art. 3 E-Commerce Directive).

It provides that the *“place at which a service provider is established should be determined in conformity with the case-law of the Court of Justice according to which the concept of establishment involves the actual pursuit of an economic activity through a fixed establishment for an indefinite period”* or a *“given period”* (rec. 19 E-Commerce Dir). This *“presupposes actual establishment of the company concerned in the host Member State and the pursuit of genuine economic activity there”*<sup>348</sup>. If a service provider has several places of establishment, one should be designated as the place of establishment from which the service concerned is provided, which should be *“the place where the provider has the centre of his activities relating to this particular service”* (rec. 19 E-Commerce Dir).

The place of establishment should *not* be *“the place at which the technology supporting its website is located or the place at which its website is accessible”* (in case of a provider of services via an Internet website) but the place where it pursues its economic activity instead.

This definition of the pursuit of an economic activity through a fixed establishment for an indefinite period resp. the relevant centre of activities could apply to the “establishment” criterion for the online making available of works – at least in a number of cases.

However, it must be borne in mind that the E-commerce Directive was explicitly adopted with the purpose of contributing to the *“proper functioning of the internal market by ensuring the free movement of information society services between the Member States”* (art. 1(1) E-Commerce Dir). Furthermore, it is applicable only to “information society services”, defined as *“any service normally provided for remuneration, at a distance, by electronic means and at the individual request of a recipient of services”* (ar. 1(2) Directive 98/48<sup>349</sup> amending art. 1(2) Directive 98/34<sup>350</sup>).

This criterion is consequently suitable to regulate the provision of a service, which could consist of providing works (e.g. music streaming or film downloading). It is less straightforward to apply it to the activities of natural persons who do not provide a “service”<sup>351</sup> or do not pursue an economic objective.

---

347 The Cable and Satellite Directive localises the protected act primarily according to a technical criterion, i.e. Member State of uplink.

348 CJEU 12 September 2006, Case C-196/04, Cadbury Schweppes plc and Cadbury Schweppes Overseas Ltd v Commissioners of Inland Revenue; See also CJEU 25 July 1991, Case C-221/89, The Queen v Secretary of State for Transport, ex parte Factortame Ltd and others; CJEU 4 October 1991, Case C-246/89, Commission of the European Communities v United Kingdom of Great Britain and Northern Ireland.

349 Directive 98/48/EC of the European Parliament and of the Council of 20 July 1998 amending Directive 98/34/EC laying down a procedure for the provision of information in the field of technical standards and regulations O.J. L 217 , 5 August 1998, p. 18-26.

350 Directive 98/34/EC of the European Parliament and of the Council of 22 June 1998 laying down a procedure for the provision of information in the field of technical standards and regulations, O.J. L 204 , 21 July 1998, p. 37-48.

351 The e-commerce Directive (as amended by Dir. 1998/48) provides the following definition of a “service”:

- AVMS Directive

The AVMS Directive indirectly uses the criterion of “establishment” to regulate services: it grants jurisdiction to the Member States to regulate “*audiovisual media services transmitted by media service providers under its jurisdiction*”. The *establishment* of an AVM service provider is the primary criterion to determine jurisdiction (art. 2 AVMS Dir). Despite the potential overlap with the E-commerce Directive, the “establishment” of the AVMS Directive has an autonomous meaning (art. 2(3) AVMS Dir).

The Directive provides a set of alternative criteria to determine the establishment in a Member State (our emphasis):

*(a) the media service provider has its head office in that Member State and the editorial decisions about the audiovisual media service are taken in that Member State;*

*(b) if a media service provider has its head office in one Member State but editorial decisions on the audiovisual media service are taken in another Member State, it shall be deemed to be established in the Member State where a significant part of the workforce involved in the pursuit of the audiovisual media service activity operates. If a significant part of the workforce involved in the pursuit of the audiovisual media service activity operates in each of those Member States, the media service provider shall be deemed to be established in the Member State where it has its head office. If a significant part of the workforce involved in the pursuit of the audiovisual media service activity operates in neither of those Member States, the media service provider shall be deemed to be established in the Member State where it first began its activity in accordance with the law of that Member State, provided that it maintains a stable and effective link with the economy of that Member State;*

*(c) if a media service provider has its head office in a Member State but decisions on the audiovisual media service are taken in a third country, or vice versa, it shall be deemed to be established in the Member State concerned, provided that a significant part of the workforce involved in the pursuit of the audiovisual media service activity operates in that Member State.*

This criterion could be applied, *mutatis mutandis*, to the right of making available to the public and to companies that offer works to the public via (commercial) online services. The “cascade” of criteria to determine the Member State where the service provider is established offers possibilities to regulate the making available of works by online service providers with several establishments in the EU.

However, the AVMS (like the Television without Borders Directive before it) pursues a different objective than copyright, which is to accomplish an internal market for audiovisual media services in the EU (cons. 10-11 AVMS Directive). Furthermore, its objective is to regulate the provisions of audiovisual media services, which are defined as “*a service as defined by Articles 56 and 57 of the Treaty on the*

“any Information Society service, that is to say, any service normally provided for remuneration, at a distance, by electronic means and at the individual request of a recipient of services.

For the purposes of this definition:

“at a distance” means that the service is provided without the parties being simultaneously present,

“by electronic means” means that the service is sent initially and received at its destination by means of electronic equipment for the processing (including digital compression) and storage of data, and entirely transmitted, conveyed and received by wire, by radio, by optical means or by other electromagnetic means,

“at the individual request of a recipient of services” means that the service is provided through the transmission of data on individual request.

An indicative list of services not covered by this definition is set out in Annex V.

This Directive shall not apply to:

radio broadcasting services

television broadcasting services covered by point (a) of Article 1 of Directive 89/552/EEC”.



*Functioning of the European Union which is under the editorial responsibility of a media service provider and the principal purpose of which is the provision of programmes, in order to inform, entertain or educate, to the general public by electronic communications networks within the meaning of point (a) of Article 2 of Directive 2002/21/EC. Such an audiovisual media service is either a television broadcast as defined in point (e) of this paragraph or an on-demand audiovisual media service as defined in point (g) of this paragraph*". These services are normally provided for remuneration and may have an industrial or commercial nature or relate to activities of craftsmen or the professions (art. 57 TFEU).

- **Data Protection Directive**

According to the Data Protection Directive, a Member State is competent to regulate the processing of personal data "*carried out in the context of the activities of an establishment of the controller on the territory of the Member State*" (art. 4 DPD). The establishment on the territory of a Member State implies "*the effective and real exercise of activity through stable arrangements; whereas the legal form of such an establishment, whether simply branch or a subsidiary with a legal personality, is not the determining factor in this respect*" (rec. 19 DPD). When the controller has establishments on the territory of several Member States (particularly by means of subsidiaries), each of the establishments must fulfil the national obligations.

The controller subject to these obligations is defined as "*the natural or legal person, public authority, agency or any other body which alone or jointly with others determines the purposes and means of the processing of personal data*" (art. 2(d) DPD). The processing of data is "*any operation or set of operations which is performed upon personal data, whether or not by automatic means*" (art. 2(b) DPD).

The definition of the scope of regulation in the Data Protection Directive is an interesting example for the protection of the making available right. The Data Protection Directive provides a definition of the restricted acts (data processing) and the responsible person (data controller) and a localisation of the protected act in the Member State where the controller has its establishment or establishments. It is also provided that if the controller is not established on Community territory and makes use of equipment, automated or otherwise, that is situated on the territory of a Member State, for purposes of processing personal data, this Member State applies its national provisions – unless such equipment is used only for purposes of transit through the territory of the Community (art. 4(1)(c) DPD).

The data protection provisions are not only binding upon service providers which pursue an economic activity, but upon anyone who processes data in the context of an "activity". A similar construction could be thought of to regulate the making available right. However, it must be observed that the Data Protection Directive adopts an "internal market approach" to the protection of the fundamental rights and freedoms, in particular the right to privacy with respect to the processing of personal data (art. 1 DPD): the free flow of data between Member States should not be restricted nor prohibited for this reason. The free flow of data and the accomplishment of the internal market are of primary importance (since uneven levels of protection constitute an obstacle to the free movement of goods, persons, services and capital – see rec. 3-7 DPD). The Directive regulates the behaviour of a person by reference to an activity with a certain continuity and the data protection provisions should not hamper the cross-border extension of these activities.

- **Services Directive**

The Services Directive further develops the freedom to provide services<sup>352</sup>. It is repeated that "*Member States [should] respect the right of providers to provide services in a Member State other than that in*

---

352 Directive 2006/123/EC of the European Parliament and of the Council of 12 December 2006 on services in the internal market, OJ L 376, 27 December 2006, p. 36–68:

*which they are established. The Member State in which the service is provided shall ensure free access to and free exercise of a service activity within its territory” (...)* (art. 16(1) Services Directive).

The establishment of the service provider is defined as the “*actual pursuit of an economic activity, as referred to in Article 43 of the Treaty, by the provider for an indefinite period and through a stable infrastructure from where the business of providing services is actually carried out*” (art. 4(5) Services Directive). The place where a provider is established should be determined “*in accordance with the case law of the Court of Justice according to which the concept of establishment involves the actual pursuit of an economic activity through a fixed establishment for an indefinite period*” (rec. 37). Where it is difficult to determine from which of several places of establishment a given service is provided, the location of the provider’s centre of activities relating to this particular service should be that place of establishment (rec. 37 *in fine*).

This criterion could be applied in relation to the making available right (as described *supra*). It should however be borne in mind that the Services Directive pursues an internal market objective and should regulate economic activities. As already pointed out, the making available right is not only relevant for economic entities (for which an “establishment” may be found) but also to private individuals (e.g. users of social media, bloggers or users of sharing platforms). Should the establishment criterion be applied as the localisation factor for the making available right, a complementary criterion should be provided for private individuals.

- **Some conclusions on the notion of “establishment”**

The E-commerce Directive, the AVMS Directive and Services Directive have as their specific objects the regulation of services, i.e. a distinct economic activity. The Directives on E-commerce, AVMS, Data Protection and Services all pursue the accomplishment of the internal market and refer to the establishment of the responsible person (service provider resp. data controller) as the starting point of the regulation.

As far as the making available right is concerned, the criterion of “establishment” may be used to regulate the behaviour of service providers in the sense of the TFEU or, more generally, persons acting in the context of a continuous, stable or organised activity. It is not so easily applicable to natural persons acting without direct economic objectives or organised activity but who are of course also capable of performing acts of making available to the public. Moreover, it should be taken into account that copyright has its own objectives, its proper logic and system of protection, which are not entirely similar to other directives. It appears from the *acquis* and the decisions of the CJEU that such copyright objective is the payment of a remuneration corresponding to the exploitation value of the work, which cannot be dissociated from the territory where the exploitation takes place. The localisation of acts of making available according to the establishment of the service provider would thus change the logic of the system by emphasising the service provider’s point of view, rather than taking the exploitation as the starting point. Such change requires an explicit policy choice, which should take into consideration all consequences for the making available right and other parts of the copyright system.

### **c) Conclusions on the localisation criteria leading to a single Member State**

In this part of the Study, we have examined how an act of making available (with cross-border effects) could be localised in one single Member State. With this objective in mind, the most straightforward construction is to define the making available right as a material act of upload and to localise this act by a criterion that leads to a single Member State (“country of origin”).

Some localisation criteria are more likely to tie the acts of making available to the public to one single Member State than others.

The localisation of the act of making available where the **servers** are located may or may not lead to one Member State. In the most straightforward cases, the works are stored on one server and it is evident in

which Member State the servers are situated. In the most complex cases, the works are stored on servers in several countries (Member States of the EU and/or third countries) and the right holders and the uploader have to keep track of the places where any particular work is stored (this is especially the case for “cloud” services, distributed computing). Moreover, such a technical criterion might soon be outdated, because of unpredictable, future technological developments.

The **centre of activities**, i.e. the establishment of a legal entity or the domicile/habitual residence of a natural person, and the **act of upload** are two sets of criteria most likely to connect the act of making available to one Member State. In the event that a legal entity has several establishments or that acts of upload are performed in different Member States, sufficient factual criteria should be provided to identify the single Member State where the protected act takes place (possibly as a cascade).

If the objective is to identify one single Member State for the acts of making available and from an “internal market” perspective, the “**centre of activities**” criterion seems the most obvious one. It has the advantage that the centre of activities of a legal person or a private person can be determined with relative ease. By contrast, this criterion may challenge the Member States’ competence to regulate behaviour taking place on their territories, in particular in case a natural person performs an act of making available in a Member State other than the Member State where she has her domicile. Applying the “centre of activities” criterion would lead to the result that, legally speaking, the act of making available is performed in the Member State of domicile A, even though the material act of making available takes place in another Member State B. Member State B would thus lose control over material acts performed on its territory and Member State A would see its copyright legislation apply to material acts performed on the territory of Member State B. Another challenge exists when, in case of territorial fragmentation of rights, an act of making available is localised in one Member State but has effects in other Member States, thus undermining the position of the persons holding rights for those other Member States (Member States of exploitation). Finally, there is a risk of location shopping in the sense that the uploader/service provider may establish her/its centre of activities in a Member State where the right holder enjoy a relatively weak level of copyright protection.

As far as the criterion of **establishment** is concerned, we have demonstrated that it occurs in other directives with an “internal market” objective and approach, which challenge some of copyright’s objectives (such as protection of the exploitation at a national level).

Another construction could be to localise the act of making available **at the location where the material act of upload was performed**. This makes sense for a natural person (who is more mobile than a service provider and thus remains subject to the law of the country where she happens to be and this in accordance with the territoriality principle) and for legal persons in simple constructions. For more complex (international) organisations it is less straightforward to identify the act of upload and to localise it (e.g. an international web search operator). A possible solution could be a fiction (or a presumption) that the act of making available to the public by legal entities takes place at the establishment of the legal entity. Inversely, the act of upload could be used to define the place of establishment of the service provider/user. Similarly to the Directive on the protection of personal data, technical elements could be used to define the place of establishment, rather than or combined with economic criteria. The protected act would be localised in the Member State where the service provider/user has its centre of activities, taking into account various criteria including the place where the act of upload happens. Such criterion would thus allow localising the restricted act in one single Member State. Unlike the criterion focusing on the “centre of activities”, the Member States would keep the power to regulate behaviour taking place on their territories (material act “upload”). Similarly to the former criterion, however, the localisation of the restricted act in one single Member State (of upload) may undermine the position of right holders for other Member States (territorial fragmentation), since the making available of works occurs in one Member State but may have effects in other Member States (access, exploitation).

Both the criteria of “centre of activities” and “act of upload” allow localising the act of making available in one single Member State (albeit with some additional criteria to facilitate the application of either criterion for legal entities or individuals as the case may be). It can be expected that this approach will facilitate the licensing process: since the restricted act takes place in one Member State, the rights have to be

cleared in that Member State. This availability work will nevertheless have effects in other Member States, which can be taken into account e.g. in the remuneration.

Both criteria allow the uploader/service provider to determine the location of the making available of works: the uploader/service provider may choose to establish her centre of activities in one Member State rather than in another Member State or to organise its activities in order to perform the acts of upload in one Member State rather than in another one. This creates a **risk of location shopping**, where the uploader/service providers chooses a Member State with a relatively weak copyright protection. Even if copyright protection is admittedly harmonised to a large extent at the European level, this risk should not altogether be excluded since important parts of the copyright systems are still left to the Member States, such as copyright contracts (the assessment of the actual risk is beyond the scope of this Study). Another risk exists in case of fragmentation of rights, in particular territorial fragmentation. Both criteria localise the act of making available in a “country of origin”, while this act has effects beyond this country (access, exploitation in other Member States). Right holders with (exclusive) rights for those Member States could see the exploitation in those territories **undermined** by a legitimate offer, coming from another Member State.

In the following sections we will examine the consequences of applying a “country of origin” principle to the making available right. The criteria of “act of upload” and “centre of activities” will be treated together since both criteria (or a combination of both) are developed in order to localise the restricted act in one Member State hence *mutatis mutandis* the same conclusions are valid for both criteria. We will analyse the effects of these localisation criteria in relation to the enforcement of the making available right in the EU (*sub 2*), to the (unharmonised) national rules of authorship and transfer of rights (*sub 3*), and to the harmonised reproduction right (*sub 4*). The current state of these legal topics has been described in part I.C of this Study. We will repeat a brief summary of the findings with respect of each legal issue and then apply it to the case of the making available right, localised in a single Member State according to a “country of origin” principle.

## 2. Conflict of laws

In this section we have considered the making available right from a “country of origin” approach. We have proposed a construction that allows localising the act of making available in one single Member State, i.e. the “country of origin”. In order to achieve this objective, the making available to the public was defined as the material act of upload (leading to the work being available to the public on its demand) and it was localised according to two selected criteria, either where the act of upload takes place or where the uploader has her centre of activities (or a combination of both criteria).

In this subsection we will verify how this construction affects the enforcement of the making available right in situations where a conflict of laws may occur. Even if the act of making available is localised in one Member State, it may have effects beyond that Member State since the work may be accessible in other Member States or the exploitation may be directed to particular Member States. These circumstances may give rise to a conflict of laws.

In this subsection, it will be examined how the issue of international jurisdiction would be solved and how the applicable law would be determined, in case the making available legally takes place in one Member State.

### a) Jurisdiction

In this scenario the act of making the work available to the public is legally localised in the Member State where the work was uploaded and/or where the uploader has her centre of activities, even if the effects can be felt beyond that country. Applying the principles of jurisdiction explained above, it seems that an alleged infringer may be sued in the courts of the Member State where she is domiciled or in the courts of the Member States where the harmful event occurred, located either at the place of the event giving rise to the infringement or at the place where the damage occurred.

In our opinion, the application of a country of origin principle would not have an impact on the application of these principles, as the rules used to determine jurisdiction are based on an assessment of the factual elements of the dispute, independent from the analysis on the substance. This means that some courts are competent to decide on the entire damage, i.e. the courts of the Member State where the defendant has her domicile/establishment or where the work was uploaded, as the place of the event giving rise to the harmful event. These factual criteria point to the “country of origin”. It so happens that the factual criteria to find competence refer to the legal criterion of localisation of the making available right. In addition, the courts of the place *where the damage occurs* remain competent. This could be the Member States where the exploitation of the work takes place (targeting of the public in one Member State). By contrast, the place where the work is merely accessible seems to be rejected by the Court of justice in the decisions *Wintersteiger* and *Pammer/Hotel Alpenhof* if there is no damage suffered in that Member State. The rule of the place of the centre of interests of the right holder, which was applied in the case of an infringement of a personality right, is not directly transposable to the case of the infringement of an economic right under copyright.

The country of origin principle does not alter the application of the rules on jurisdiction. It seems however that these rules point to the courts of the Member States of origin for a ruling on the entire damage (by contrast to a decision on the damage suffered on the territory of one Member State only).

In our example, a journalist writes articles for a French newspaper. Her articles are made available to the public by a news aggregator with establishment in Ireland. Arguably the act of upload takes place in Ireland, at the aggregator’s establishment, hence the event giving rise to the damage occurs in Ireland. The search engine operator may by consequence be sued in the Irish courts, for all the harm done.

The news aggregation website is however directed at the Belgian public (at least partially, in so far as it offers a “national” news page). The Belgian courts will therefore also be competent to hear the case on the merits, restricted to the damage that occurred in Belgium. In this case most or all of the damage will arguably occur in this one country. If the website is also accessed by a certain public outside Belgium (e.g. by Belgian expats), then it could be argued that the courts of these countries of “overspill” have jurisdiction as well (albeit for a smaller part of the damage).

It can be concluded that the outcome is the same as the current situation, when the rules on jurisdiction are applied to an act of making available that is localised in one single Member State (country of origin).

## **b) Applicable law**

The country of origin principle in the SatCab Directive is a rule that designates the application of the law of one Member State, instead of several legislations. Several authors analyse it as a provision implicitly ruling the conflicts of laws, which would have a hybrid character (between substantial law and private international law)<sup>353</sup>.

In the scenario where an act of making available is localised in the country where the act of upload has taken place or where the uploader has her establishment, the restricted act takes place in its entirety in one single Member State. The effects of the restricted act, by contrast, are possibly felt in several Member States (e.g. where the exploitation takes place or where the work is accessed). Since the restricted act takes place in one country, which serves as a country of origin, the purpose is to avoid an actual conflict of laws and the act of making available is entirely governed by the law of the place where it

---

353 M. HO-DAC, *La loi du pays d’origine en droit de l’Union européenne*, Bruylant 2012, 245-250; J.-S. BERGE, *La protection internationale et communautaire du droit d’auteur*, 1997, 395-396.

was performed. The cumulative application of several national laws is thus avoided (see rec. 14-15 Satellite and Cable Directive)<sup>354</sup>.

This means that the “uploader’s law” is applicable to the merits of the case<sup>355</sup>. On the merits, an infringement in any of those targeted territories will be judged by the law of the Member State where the service provider has uploaded the works or has its establishment. By consequence, the damages will be assessed and a cessation measure (as a corrective measure) will be admitted according to this law. This is even the case if the exploitation is not actually turned to the country of origin: a service provider may have its establishment in one Member State and offer, from this geographical basis, services that target several, distinct national publics. Right holders will have access to harmonised enforcement measures throughout the EU (insofar as the harmonisation is effective). The damages are evaluated according to the law of the country where the infringement has taken place. The possible adverse effects could be mitigated by the principle that the compensation should reflect the value of exploitation in the territories concerned (cf. *Lagardère, Stichting De Thuiskopie*<sup>356</sup>).

The localisation in the Member State of upload or establishment leaves the right holders vulnerable to acts of making available originating from outside the EU. In order to offer protection against acts from beyond the reach of the European harmonisation a safeguarding clause may be considered (see *mutatis mutandis* the provision in the Satellite and Cable Directive).

The country of origin principle may however be expressed as a substantial rule that does not interfere directly on the issues of applicable law. The rule “country of origin” then localizes the protected act in one country but it does not expressly rule the applicable law, which will be determined according to the general principles of conflicts of laws.

In that hypothesis, the law applicable will be determined according to the rule *lex loci protectionis*. The judge thus has to apply the law of the country for which a protection is claimed, which can refer either to the law of the country of transmission or to the law of the country of reception. That issue is traditionally solved by the national courts depending on the connecting factors between the dispute and either of these countries. The country of transmission will correspond to the country of origin (place of upload or place of establishment of the uploader). Still, a court may apply the law of the country of reception, which might differ from the country of origin and refer to the Member States to which the work made available is exploited. In the European Union, the laws of the countries of reception should nevertheless localise the act of making available according to the country of origin principle as, consequently, apply the law of the country of origin as to the substance.

### 3. Authorship, ownership and transfer of rights

The authorship of copyright protected works is only partially harmonised at the European level. The Member States are competent to determine authorship of works that are not subject to a European directive (such as computer programs, databases or audiovisual works). All Member States under consideration adopt the “creator doctrine” to some extent. There are however important differences, in particular with regard to collective works, works created by an employee in the context of her employment and even audiovisual works (although the effects are mitigated by the presumed transfer of rights in favour of the producer). Moreover, the issue of copyright contracts has not been harmonised at all, which results in important disparities between the national copyright laws. Some Member States barely regulate

---

354 This solution goes against the ruling in *Sportradar*, where the law of the place where the targeted public is present was considered pertinent to determine the applicable law and where the Court had to rule in absence of a “country of origin” principle.

355 This would lead to the application of the law of the country of transmission of the work, which could be seen as contradictory with art 4 of the Regulation Rome II.

356 In *Stichting De Thuiskopie*, it was considered that the “fair compensation” was meant to compensate the authors for the prejudice suffered from the exception for private copying. It can therefore be argued that the same principle applies to the compensation of prejudice caused by an infringement.

the contracts on the exploitation of copyright works, other Member States impose more or less detailed conditions for the validity, interpretation or enforcement of copyright contracts.

These disparities are likely to have an impact on the position of the right holders when applied to a making available right that is localised in one single Member State.

The making available right is understood in this section as a material act of upload, localised in one Member State (according to a criterion such as the location of the material act of upload or the centre of activities of the uploader). Such localisation criterion is considered a “country of origin” criterion, comparable to the “country of origin” principle applied in the SatCab Directive (93/83/CE). Yet it has to be verified which law is applicable: even if the restricted act is localised in one Member State, it has effects in other Member States, which may raise a conflict of laws.

For the time being, it is proposed that this “country of origin” principle applied to the making available right be considered as a rule of substantive law determining the territorial reach of the substantive national legislation. Such rule would localise the relevant copyright act in one single Member State and accordingly lead to the application of the law of that Member State rather than several legislations.

The act of making available can be localised in one Member State, i.e. where the work was uploaded and/or the uploader has her centre of activities (country of origin). The *locus protectionis* is the only country where the act of making available is localised, even if this act has effects in other Member States. The copyright law of the “country of origin” would be the only applicable law to the act of making available<sup>357</sup>.

#### a) Authorship and initial ownership

**Authorship and initial ownership.** This entails that the authorship or initial ownership is determined in accordance with the laws of the Member State where the act of making available takes place (i.e. Member State of upload or where the uploader has her centre of activities). Depending on the country where that act takes place, the author/owner of the rights might be a different person. By consequence, it affects the acquisition of licences and right to take legal action in case of infringement.

If a work is made available to the public by an uploader in Member State A (“country of origin”, i.e. upload or centre of activities), then all copyright questions relating to this making available are treated in Member State A. It will be determined in accordance with the copyright rules of Member State A who should be considered the author of the work (i.e. creator, initiator of a collective work or employer). The outcome could be different in case the same work was made available from Member State B, in which case the authorship would be determined in accordance with the laws of Member State B (i.e. creator, initiator of a collective work or employer). Regardless of whether the work was made available in Member State A or B, the effects may be the same and the work may be accessible to the public in all the Member States of the European Union.

So it matters where the uploader/service provider chooses to make the work available to the public (country of origin): depending on the rules of authorship of the Member State, she will have to clear the making available right from the creator or, as the case may be, the person taking the initiative to create a collective work or the employer of the maker of a work under an employment contract. Inversely, in case of infringement, the person who can claim infringement of her copyright is determined in accordance with the copyright law of the Member State where the act of making available was performed by the (alleged) infringer. In theory, such a situation may affect the legal certainty and encourage acts of forum shopping<sup>358</sup>. Arguably this is not an insurmountable problem in practice, given the circumstance that in

---

357 M. HO-DAC, La loi du pays d'origine en droit de l'Union européenne, 249.

358 Final report to the study on intellectual property and the conflict of laws, 112.

many sector the exploitation rights are explicitly dealt with in contracts. This should however be empirically verified.

An example may clarify this scenario. A news aggregator making news articles, published online, available to the public needs to clear the right of making available to the public. Leaving aside the contractual assignment for now, this aggregator needs to obtain the authorisation of the journalist (creator) or the publisher (employer or initiator of a collective work). This depends on where the act of making available was performed.

- The country of origin regarding the act of making available is France (the news aggregator has its establishment in France or performs the material acts of upload in France). The news aggregator should acquire the making available right for the news articles from the publisher and the journalist (art. L132-36 and L-132-40). The country of origin regarding the act of making available is Belgium (the news aggregator has its establishment in Belgium or performs the material acts of upload in Belgium). According to Belgian law, the journalist remains the initial owner of copyright. The publisher holds rights only by virtue of a contractual transfer of rights.
- The country of origin regarding the act of making available is the UK (the news aggregator has its establishment in the UK or performs the material acts of upload in the UK). Applying the UK law to the transfer of rights, the employer holds the economic rights to the newspaper article. The news aggregator should acquire the making available right from the newspaper publisher without regard for the journalist.

Inversely, in case of infringement, it is either the journalist or the publisher or both who can take legal action and claim cessation or damages from the news aggregator. Again, who can initiate the legal action depends on where the work was made available (i.e. where the material act of upload was performed or where the news aggregator has its establishment):

- If the country of origin of the act of making available is France, then the journalist and the publisher are entitled to sue the website.
- If the country of origin of the act of making available is Belgium, then the journalist is entitled to sue the website (leaving aside contractual transfers).
- If the country of origin of the act of making available article is the UK, then the employer is the holder of the economic rights and is therefore entitled to sue the website and claim for economic compensation.

Combined with the application of the *lex loci protectionis*, the country of origin principle would thus have an impact on the determination of authorship and initial ownership. Moreover, the location of the making available and thus the applicable copyright law are determined by the person who makes the work available. The uploader can consequently control (intentionally or not) which regime is applicable and she can even organise her activities in function of the most favourable regime. It should be remembered that the accessibility to the work is not relevant here.

The practical effects of that conclusion would need to be examined by an economic market study, on the basis of a systematic presentation of different levels of protection.

**Lex loci originis.** By contrast, if the *lex loci originis* principle is applied to determine the authorship of a work, then the initial right holder is invariable, regardless of where the act of making available is localised. According to the principle of *lex loci originis*, the initial owner of copyright is determined in accordance with the law of the country of origin of the work (not the origin of the making available), i.e. the country of the first publication of the work or, in case of unpublished works, the country of which the author is a national (art. 5(4) BC). In that case, the same person holds the making available right, regardless of where the act of making available to the public is performed.

The application of a new localisation criterion to the act of making available would not affect the determination of authorship. Indeed, that localisation criterion would only apply to the act of exploitation of the work, without prejudice to the rules determining the existence of a copyright protection or establishing



the initial owner of that protection. The uploader/service provider should determine for each work she intends to make available to the public who the initial right holder is, in accordance with the *lex loci originis*. It matters not where the act of making available is localised: this has no effect on the person holding the making available right. Once this person identified, the licence contract between the right holder and the uploader/service provider would be governed by the law of the contract. Inversely, the author identified according to the copyright law in the country of first publication of the work has the right to claim infringement of her right, if her work is made available without her consent (unless she has transferred her rights to a third party).

In case the *lex loci originis* is applied, the need to harmonise at the European level the rules on the determination of authorship appears to be limited. Still it would be a cumbersome task to clear the rights, especially for service providers offering a wide range of works (such as automated aggregators or music providers). Practically, the need to harmonise the rules on authorship and initial ownership should be assessed taking into consideration the contractual practices in the different sectors. If it appears that (in some sectors) the rights are transferred by contract to one person or a limited number of people, then the need to harmonise the (preceding stage) of authorship or initial ownership would be discarded. This assessment is however beyond the scope of this Study.

## b) Transfer of rights

**Transfer of rights.** As far as the transfer of rights is concerned, a distinction has to be made between contracts operating a transfer of rights concluded *prior* to the making available of the work, and contracts expressly concluded to give an authorisation for the making available of the work (“contracts with the purpose of the making available of the work”).

**Preceding transfer of rights – derived ownership.** We have described how the uploader/service provider should proceed to determine the author or initial right owner of a work she intends to make available to the public. If a contractual transfer of the rights on a work has occurred, the uploader or the service provider wanting to make that work available should acquire the rights in conformity with the contractual arrangements of the author or initial right owner. Where the making available by the candidate uploader does not matter in this respect, since the existing contracts determine which party holds the relevant making available right. By contrast, it may matter where the making available takes place in case the making available rights have been granted to different parties per national territory (territorial fragmentation). It should then be determined in which Member State the intended act of making the work available to the public will be situated, in order to determine which party holds the (exclusive) rights to this territory and who can grant a licence to the candidate uploader.

Similarly, if the work is made available by a user or a service provider without prior consent of the rights holder, the person having acquired the rights in execution of that copyright contract will be entitled to claim compensation.

**Contract operating transfer of making available right.** The country of origin principle as it is applied in the Cab/Sat Directive is traditionally analysed as a rule determining the law applicable to contracts operating the transfer of rights for the purpose of the act of retransmission<sup>359</sup>. Similarly, the application of a criterion of localisation to the making available right could have a consequence in the determination of the law applicable to the contracts operating the transfer of rights on works with the purpose to make them available on internet. The law applicable to these contracts would necessarily be the law applicable in the country where the act is deemed to occur.

---

359 Report from the European Commission on the application of Council Directive 93/83/EEC on the coordination of certain rules concerning copyright and rights related to copyright applicable to satellite broadcasting and cable retransmission COM(2002) 0430 final, 6.

When the act of making available is localised in a single Member State of “origin” (upload or centre of activities of the uploader<sup>o</sup>, then the contracts clearing the rights for this making available are subject to the law of the Member State of origin (i.e. where the upload took place or where the uploader has her centre of activities). As described *supra*, the national copyright laws provide different rules on copyright contracts and impose different conditions of validity, interpretation and enforcement of copyright contracts, some being more protective than others. Since the uploader’s acts determine where the making available is localised, she will be able to determine (directly or indirectly) which legal regime applies to the copyright contracts on the making available of works. In theory, the uploader could favour a copyright regime that less strict and less protective of the authors and right holders.

### c) Impact of Premier League on the country of origin principle

**Relevance for the making available right.** If it is an option to define the restricted act and the localisation criterion in such a way that the making available of a work to the public takes place in one Member State to the model of the “country of origin” principle in the SatCab Directive, then the analogy should be pushed further and other consequences should be anticipated. Should a “country of origin” principle apply to the making available right, the restricted act is localised in one Member State regardless of the extra-territorial effects of this restricted act. The restricted act would be defined as the material act of upload, but leads to the work being accessible for an extended period of time and to a public that is not necessarily territorially confined. This is also the case for satellite broadcasts: the protected act of communication to the public by satellite refers to a precise (technical) act of introducing the signals into a communication chain that makes it possible for people in the international “footprint” of the broadcast to receive the signal (and therefore the protected work).

In a recent case, the CJEU examined certain contractual practices of a right holder and satellite broadcasters restricting the territorial reach of the satellite broadcast of football matches of the UK competition. Given the analogy between the “country of origin” principle in the SatCab Directive and the one under consideration here, we will examine the consequences of the CJEU ruling in *Premier League* for the making available right. First we will summarise the decision in *Premier League*, then we will examine how this ruling may affect the contractual practices with regard to the making available of works localised in one Member State but with a reach beyond that Member State. The aim of the present section is not to propose a complete analysis of the whole *Premier League* decision.

**Facts.** In *Premier League*, the broadcasting rights (live transmission) on the first class football competition in England were exploited via territorial licences granted for a 3 year terms. Licences were awarded by the Football Association Premier League (FAPL) based on an open tender procedure with the purpose of maximising the value of the rights. In order to reach that goal, each broadcaster getting a licence was allowed to retransmit the Premier League matches on a national territory exclusively. Furthermore, only one broadcaster was licensed per territorial area and each broadcaster had to encrypt its signal in order to prevent the reception of its broadcasts by viewers situated outside the area for which it hold the licence. The broadcasters also had to ensure that no decoding devices were authorised so as to permit any viewer to receive their transmissions outside the territory licensed.

Despite these restrictions, certain bars in the United Kingdom decided to use Greek decoding devices to access the Premier League matches retransmitted by the Greek broadcaster NetMed Hellas, instead of the version retransmitted by the broadcaster BskyB, the holder of the exclusive licence for the United Kingdom. The subscription to the Greek broadcaster was indeed less expensive than the one to BskyB.

FAPL and BskyB brought proceedings against the suppliers of the foreign decoding devices and owners of public houses who used them and allegedly infringed their copyrights. One of the issues raised concerned the lawfulness of the legal regime preventing the broadcasters from the retransmission of the subject-matter outside the territory covered by the exclusive licence granted by FAPL. The Court had to evaluate whether such provision constitutes a restriction on the freedom to provide service protected by art. 56 TFEU.

**CJEU Ruling.** In the United Kingdom, the national legislation confers a legal protection to contractual clauses that prohibit the access to satellite transmission services from another Member State. The Copyright, Designs and Patents Act prohibits the dishonest reception of a programme included in a broadcasting service provided from a place in the United Kingdom with intent to avoid payment of any charge applicable to the reception of the programme<sup>360</sup>. That prohibition also benefits to persons who make charges for the reception of programmes included in a broadcasting service provided from a place in the United Kingdom or in any other Member State and to persons who send encrypted transmissions from a place in the United Kingdom or in any other Member State. They are entitled to prohibit the importation, the sale, the installation and other forms of distribution of any apparatus used to enable persons to access the programmes and/or to circumvent conditional access technology<sup>361</sup>,

The Court found that such legislation combined with the contractual practices implemented by the Premier League constitutes a restriction to the freedom to provide services, unless it can be objectively justified (FAPL, par. 89).

According to the Court, the protection of intellectual property rights may justify a restriction on fundamental freedoms (par. 94), provided that the specific subject-matter of the intellectual property is to ensure for the right holders a protection of the right to exploit commercially the marketing or the making available of the protected subject-matter (par. 107). However, it does not guarantee the right holders the opportunity to demand the highest possible remuneration; only an appropriate remuneration for each use of the protected subject-matter is ensured (par. 108). Defining the concept of an appropriate remuneration, the Court declared that such remuneration must be reasonable in relation to the actual or potential number of persons who enjoy or wish to enjoy the service (par. 109).

In the Premier League decision, the Court of Justice found that the premium paid by the broadcasters in order to be granted absolute territorial exclusivity went beyond what was necessary to ensure appropriate remuneration for the right holders and consequently constituted a restriction to the freedom to provide services, because it resulted in artificial price differences between the partitioned national markets (par. 115).

**Analogy with the making available right.** The Premier League decision may affect the transfer of rights on online exploitation forms covered by the making available right, in the hypothesis where the country of origin principle is applied as localisation criterion.

There are indeed similarities between the acts of communication to the public by satellite and the making available of works on the internet. As described *supra*, the making available of works has cross-border effects (unless technical measures are applied to restrict access) but it would be defined and localised in one single Member State ("country of origin"). The application of the country of origin principle to the making available right could thus lead to a context similar on a technical and a legal point of view to the facts that have led to the Premier League decision.

Similarly to what happened in *Premier League*; it is conceivable that a right holder (such as a film distributor or a record label) grants an (exclusive) licence to a service provider (e.g. an online film platform or an online music service) to make available a film or music, valid for the territory of one Member State and on condition that access to this work be restricted to this one Member State. The right holder may have sound economic reasons for such request, e.g. the ambition to maximise the exploitation value of the work by organising the territorial segmentation of advertising. Such contract would require the service provider to implement access restrictions, preventing users residing outside this national territory from consulting the work. Moreover, these technical restrictions could legally be protected as technological measures (art. 6 InfoSoc Dir). The territorial exclusivity per national territory may be beneficial to either party as the case may be: the right holder may negotiate a higher fee (or a "premium") or a service

---

360 Art. 297.

361 Art. 298.

provider may demand exclusivity as the price of distributing the content. This exclusivity may be temporary.

**Projected consequences for the making available right.** The *Premier League* ruling does not prohibit the grant of exclusive licences on the territory of one Member State, considering that such exclusivity by itself would not affect the freedom to provide services. The CJEU is nevertheless critical towards a combination of an exclusive licence to broadcast a work in a Member State (via an encrypted signal), the contractual obligation having the effect of restricting the reception of the broadcast to the territory of the same Member State (by regulating the distribution of decoders) and the statutory (UK) protection of such technical restrictions (via decoders). A similar combination could be thought of with regard to the online exploitation of works. The exploitation would be protected by the making available right, so the right holder could grant an (exclusive) licence allowing the making available of a work in one Member State. The same contract could contain the obligation to restrict access to the programmes to the territory of the Member State covered by the licence through geo-blocking measures, which are in turn legally protected as technological measures (cf. art. 6 of the Directive 2001/29). This combination of legal, technical and contractual measures would make it impossible for the work to be accessed from other Member States than the one covered by the licence and could be considered an infringement of the freedom to provide services.

A restriction of the freedom to provide services may however be justified, e.g. for the protection of the specific subject matter of copyright. It could for example be argued that the purpose of the territorial exclusivity and the geo-blocking measures is to protect the exploitation of the work and for the right holder to receive an “appropriate remuneration”.

In *Premier League*, the Court gave some indications on the factors that could be considered to determine whether a remuneration is “appropriate”: the remuneration should be reasonable in relation to the economic value of the service, in particular the actual or potential number of persons who enjoy or wish to enjoy the service (par. 109), the language of the broadcast (par. 110), but possibly also territorial exclusivity (par. 114) though not “absolute” territorial exclusivity that leads to artificial prices between partitioned (national) markets (par. 115).

According to these criteria, there could be situations in which a justification for such restrictions to making a work available online within the boundaries of a single Member State could be put forward:

- **Exploitation windows. Exclusivity.** In some sectors the exploitation of the work is organised in national windows. This is for example the case for some audiovisual (cinematographic) works (cinema release, DVD, on demand availability online and/or via digital TV, free TV broadcast). These windows are often determined at the national level.

This national exploitation scheme could be affected if the audiovisual work were available on demand via the Internet. For example, a French provider of online services acquires an exclusive licence to make a film available online for a certain time. This period of exclusivity is determined on the basis of the French exploitation scheme. A different exploitation scheme of the same film applies however in Belgium and the service provider that has acquired the exclusive “on demand” rights in Belgium is entitled to make the film available before the French service provider. Offering services in French and actively targeting (partially) the same French speaking public, the Belgian service provider may undermine the exploitation by the French service provider (or even more generally the French exploitation scheme).

In such a case the contractual territorial restrictions could be justified to protect the exploitation of the work and ensure the appropriate remuneration of the right holder but this will depend on the all circumstances of the case, in particular the economic context (e.g. commercial practices per sector, temporary exclusivity for one service provider; significant difference between the national exploitation windows,...).

- **Exploitation windows. National competitors.** Another possibility for the right holder is to grant simple licences to several service providers and impose a contractual obligation to restrict access to these works to the territory of one Member State. Such a restriction to the freedom to

provide services could be justified in the case of national exploitation windows, where a work (a film, a book or an album) is released in different countries at different times, but where several providers within one country are entitled to simultaneously offer the work to the public.

In general, other than during the initial release phase, it will be difficult to justify such restriction from the point of view of the right holder. Moreover, territorial restrictions are not imposed in all sectors, e.g. most (old and new) music is offered at the same time via several services. Even without territorial exclusivity, it is possible for the right holder to negotiate and receive an appropriate remuneration from the service provider in function of the actual or potential audience (including those residing in other Member States).

Inversely, territorial restrictions could be imposed not so much at the request of the right holder but of the service provider. Such restrictions could be justifiable in certain circumstances, e.g. of the service provider's interest to control the copyright remunerations. If the remuneration is supposed to reflect the actual or potential public in all Member States, a small company may want to restrict the public having access to the works, thereby limiting the amount of the licence fee to be paid to right holders.

**Conclusion.** The outcome of the Premier League decision might thus affect the behaviour of the rights holders in the way they transfer their rights if the country of origin was applied to the making available right. We expect that copyright holders may be able to justify territorial access restrictions in certain cases (e.g. with regard to a temporary exclusive licence for new releases in a certain exploitation chronology) but not so much in other cases (e.g. with regard to the online exploitation of (older) works).

#### 4. Reproduction right

**Summary.** It has been found that the right of making a work available to the public and the reproduction right apply cumulatively to the use of a work. The reproduction right is currently understood in a technical way, which means in practice that a reproduction in the technical sense, a "copy", is equated to a reproduction in the legal sense. The scope of protection of this economic right is limited by the mandatory exception for temporary acts of reproduction (art. 5(1) InfoSoc Dir). Despite several decisions of the CJEU, the overall scope of protection of the reproduction right is uncertain, especially in the light of non-permanent copies at the end-user's end (e.g. streaming or browsing).

Reproductions have been identified "upstream" and "downstream" in the average online on-demand use, i.e. on the server where the work is hosted for transmission and at the user's end, after transmission on demand (leaving aside copies in the course of the transmission via a network).

The reproduction right being applied cumulatively to the same processes as the making available right, an additional burden may be imposed upon the person who wants to clear the relevant rights to offer a service (the reproduction right and the making available right as a species of the right of communication to the public are not necessarily held by the same persons). Also, it may increase the number of interested parties in case of an infringement.

Having defined the making available to the public as a material act of upload that is localised in one Member State (where the uploader has her centre of interest or has performed the act of upload), it should be verified whether the location of the **upstream reproduction** coincides with the Member State where the work is made available. The same should be done for the **downstream reproductions**, including for the copies made when an end-user actually accesses or receives a work. Some temporary copies for viewing a work will be exempted but more permanent reproductions will require the author's consent, wherever the act of reproduction is performed and even outside the territorial scope of the making available right.

In the hypothesis under consideration, the making available right is constructed as to be localised in one single Member State ("country of origin" principle). It is defined as the material act of upload (regardless of the wide accessibility that follows from this upload) and it is situated on the territory of one Member State.

One possibility is to localise the act of making available in the **Member State where the material act of upload takes place**. This would correspond to the Member State where the person uploading the work is present while she is uploading the work. For legal entities, it is less straightforward to apply this criterion (especially if technical operations are performed in several Member States). A more suitable criterion would be the Member State where the legal entity (service provider) has its **establishment**.

The reproductions, inherent to the making available to the public, do not coincide with the act of making the work available to the public and may take place in other Member States than the act of making available localised in one “Member State of origin”.

- The “upstream” reproduction (on the server where the publicly available work is hosted) takes place in the Member State where the reproduction is made.

This may coincide with the Member State where the act of making available is localised, i.e. where *act of upload* is performed<sup>362</sup>. Arguably, the material act of upload cannot be distinguished from the material act of reproduction on the hosting server. However, it must be reminded that the Member States are free to determine who they consider as the person making a reproduction and that different solutions may exist (technical intervention v instructions or beneficiaries).

If the act of making available is localised in the Member State of *establishment*, the act of reproduction may be situated in the same or in another Member State, i.e. where the material act of reproduction takes place.

A reproduction could also be regarded as a continuous act, since it is kept for a longer period of time and be localised instead in the country where the **servers** are located on which the work is hosted. This is not necessarily the same Member State as where the material act of upload is performed or where the uploader has her centre of activities.

The localisation of the reproduction is not harmonised and does not automatically follow the localisation of the act of making available. The reproduction and the making available rights being autonomous rights, relevant acts could be found in several Member States. In theory, this could lead to a situation where one material act of uploading a work to a distant server is qualified as an act of making available in one Member State and a reproduction in another Member State. The technical approach to the reproduction right would bring about a result that a “country of origin” principle applied to the making available is meant to avoid, i.e. the difficulty of determining where the act of upload takes place.

- The “downstream” reproductions (i.e. downloads and those access copies that are not covered by the exception for temporary acts of reproduction) are made at the end-user’s end.

The downstream reproduction made in the Member State where the work was made available (i.e. where the act of upload takes place or at the centre of activities) will be localised in this Member State. If the work is *accessible in other Member States* than where it was made available to the public, then the reproductions that follow directly from this availability will take place in other Member States. **The mere accessibility may not require a licence based on the making available right but by virtue of the reproduction right**. While the making available right is defined as to exclude the “mere accessibility” from its scope, the simple consultation (reading, viewing) of a work may entail copies that are considered reproductions

---

362 In Pinckney, the Advocate-General considered the case of pressing CDs and qualified this as an act of reproduction. By principle, infractions of the reproduction right are strictly territorial (“les atteintes au droit de reproduction revêtent en principe une dimension strictement territoriale”). The Advocate-General found that the territory of the reproduction was Austria, without however specifying why this was so (location where the reproduction was made, establishment of the distributor). Any extraterritorial effects were due to subsequent acts of distribution or communication to the public (Advocate-General in Pinckney, par. 25). To determine which court is competent to hear the case with regard to the reproduction, article 5(3) Regulation 44/2001 grants jurisdiction to the court where the harmful event occurred, which may be understood as either the location of the event giving rise to the damage or where the damage is felt. In case of a reproduction, the location of the event giving rise and the damage are identical, according to the Advocate-general (par. 53): “le préjudice résultant de l’atteinte à un droit de reproduction est entièrement réalisé du seul fait de l’accomplissement de l’acte de reproduction et survient donc dans le même lieu que ce dernier”.

wherever they are performed. This is not only the case for downloads of permanent copies but also for access copies, that are not covered by any exception.

It is remembered that the burden of acquiring a licence for this reproduction may be attributed according to different national rules. The service provider should therefore take into account the eventuality that the work will be reproduced in any Member State where the work is accessible.

In addition to a single act of making available to the public localised in one Member State, several reproductions may be found in the same or in different Member States, possibly “upstream”, certainly “downstream”. If the work is accessible in other Member States than the “country of origin”, then it is likely that a reproduction will be made in another Member State.

With a lack of harmonisation of the localisation criteria and the exceptions, it should be verified in which Member State the reproductions are made, who is responsible for the reproduction and whether the author’s consent is required.

## 5. Intermediate conclusion

In this section we have examined a construction that allows localising the act of making a work available to the public in one single Member State. The restricted act was defined as the material act of upload (leading to the work being available to the public). The localisation criterion could be either the centre of activities of the uploader (establishment, domicile or habitual residence) or the material act of upload. Both criteria could be combined, in order to solve some practical objections. The localisation criterion “act of upload” may be difficult to apply to legal entities with complex, international organisation structures so this criterion could be complemented by a fiction for legal entities that all acts of upload take place at the establishment of the legal entity.

The localisation in one Member State has some legal consequences.

Firstly, when the making available of a work entails pertinent facts in several countries, some **conflicts of laws** may arise, in particular with regard to the competent jurisdictions and the applicable law.

Several courts may have competence to rule in a dispute with cross-border elements. For provisional (protective) measures, the courts of any Member State may be seized provided that the intended measure has an effect on the territory of that Member State. On the merits, the competence of the courts depends on the measure claimed. A ruling on the entire damage can be expected from the courts of the Member State where the defendant has her domicile/establishment as well as from the courts of the Member State where the event giving rise to the infringement happened, i.e. where the act of upload has taken place or where the uploader has her centre of interest. These locations correspond to the “country of origin”. In addition, the courts of the countries where the damage occurs are competent to state on the part of the damage that is felt in that Member State. This corresponds to the Member States where an exploitation of the work can be found (where the public is targeted). Given the rulings of the Court in *Wintersteiger* and *Pammer/Hotel Alpenhof*, it is not sufficient that a work is accessible to find jurisdiction in that Member State.

While the courts generally try to apply the *lex fori*, the applicable law to the making available right should by principle be determined by reference to the principle *lex loci protectionis*. The Member State for which protection is claimed could be taken to refer to the country of transmission or reception, depending on the connecting factors. However, a provision that would legally localise an act of making available in the Member State of origin could entail that this is also the country for which protection is claimed, if that provision is interpreted as a rule of applicable law.

The localisation of the making available right in one Member State results in the following situation for the stakeholders.

The **author or right holder**, whose rights are infringed, has different options. For provisional measures, a legal action can be brought before the court of any Member State, even if these courts are not

competent to decide on the merits of the case. The entire damage can be claimed before the courts of the defendant's domicile or where the act of upload has taken place. This court will apply the law of the Member State for which protection is claimed, i.e. the law of the country of origin or the laws of the countries of exploitation.. The author or right holder can also seize the courts of the Member State where the damage is felt, which will then have to decide the case by applying the law of the Member State for which protection is claimed, i.e. the law of the country of origin or the law of the country of exploitation (*lex fori*). It is unlikely that an action for the entire damage can be brought before the courts of the Member State where the author/right holder has the centre of her interests, as was the case in the CJEU's ruling in *eDate Advertising*. This case dealt with personality rights, which are distinct from the making available right that is seen as an economic right granted under copyright.

The author/right holder may thus have to act outside the Member State where she has her centre of interests and the applicable law is country of origin, which de facto depends on the behaviour of the alleged infringer.

The **alleged infringer** may be brought before the courts of her domicile/establishment or where she has performed the act of upload and will be judged by the law of the Member State of origin - which also depends on where she performs the act of making available - or by the law of the countries of exploitation. However, she can also be called to defend herself before the courts of other Member States for provisional measures, cessation measures on the merits or partial reparation of the damage, which will be assessed by the laws of the country of origin or by the laws applicable in these countries of exploitation.

The localisation in one country of origin has an impact on who is identified as the **author or initial owner of copyrights**. The national rules on authorship and initial ownership are quite divergent: all Member States see the creator of a work as its author to a certain extent but some have specific rules for collective work, works made by an employee in the context of her employment contract or provide presumed transfers of rights in favour of other persons than the author/creator. Different persons may thus be indicated as the author or initial right holder, depending on the Member State where the work is made available to the public. If the *lex loci protectionis* principle is applied or if the "country of origin" principle is read as a principle containing a conflict of laws rule, then different persons may be regarded as the authors or initial right holders in function of the applicable law (creator, person taking the initiative for a collective work, employer, film producer). Moreover the outcome depends on a factor that is determined by the uploader/service provider, i.e. on where the act of making available is performed (i.e. where the material act of upload is performed or where the uploader has her centre of activities). An alternative is to apply another principle to determine the applicable law, i.e. the *lex loci originis* which ensures that the applicable law is invariably the law of the country of origin of the work (rather than the country of origin of the making available).

In principle the uploader or service provider who intends to make the work available to the public must clear this right before using the work (e.g. for a blog, an online music store or a film platform). The definition and localisation in one Member State favours the uploader/service provider in the sense that the making available right should be cleared in one Member State only (rather than in several Member States where the work is accessible). Since the rules on authorship and initial ownership are not harmonised, she must pay attention to the national rules and identify her contracting party accordingly (especially if the work is a collective work, if it is created in the framework of an employment contract or if other presumptions of transfers apply). This disparity could be solved by harmonising the rules on authorship and initial ownership, although there are few indications that such need exists in practice.

It is common for the author or the initial right owner to entrust the exploitation of the work to another party, such as a publisher, a record label or a film producer. Contractual transfers by the initial right owner or subsequent contractual operations could lead to a fragmentation of rights: the rights can be divided between different persons and on a territorial basis (even granting territorial exclusivity to one partner). Where the making available is localised, determines whose rights are at stake.

The localisation of the making available right in one Member State results in the following situation for the stakeholders.



The **right holder** can grant a licence for making the work available from one Member State, in return for a licence fee based on the exploitation value of the work (actual or potential public).

- Divergences on the national rules on authorship and initial ownership may (in theory) lead to different entitlements. An initial right owner in one Member State may see herself deprived of any right if another person is considered the initial right owner in another Member State.
- Territorial fragmentation. Different persons may hold making available rights for different territories. The making available right is localised on the territory of one Member State but has effects in other Member States.

The licence granted by the person who owns rights in one Member State may affect, even undermine the rights of persons in other Member States. The exploitation of the work by making it available on demand may be directed at one Member State; while the underlying act of making available to the public is localised in another Member State (upload, centre of activities of the uploader) and requires the consent of the right holder in that Member State, which means that the right holder in the Member State of exploitation is considered irrelevant in this process. There is no necessary link between making available of the work and its exploitation.

Right holders may use contractual constructions to restrict the exploitation of the work to national territories, thus requiring uploaders/service providers to make a work available in one Member State and to restrict access to the work to users being present on the territory of that Member State (i.e. excluding access from outside the Member State). The effect of localising the act of making available in one Member State is thus undermined by contractual practice. Such practices may constitute an infringement on the freedom to provide services within the EU or competition law. Such restrictions may however be justified by demonstrating that these are necessary to protect the essential subject matter of copyright protection.

Inversely, the person making the work available, i.e. the **uploader**, who may be a private person or a (commercial) service provider, should obtain the right holder's consent prior to making the work available to the public. Her act of making available will be localised in one Member State, where she should clear this making available right. This means that the uploader should identify author, initial or derived right holder(s) in the MS where the making available takes place.

- **Author or initial right owner.** Since there is no harmonisation in this field, the copyright laws of the Member States consider different people the author or initial owner of the making available right. The uploader's task may be complicated since she should verify which regime applies in the Member State where the work is made available.
- **Derived ownership.** The making available right may be transferred by contract to a third party. The uploader has the burden of identifying who holds the rights for the relevant territory.

Once the uploader has identified the person holding the rights for the relevant territory, she can acquire licence for making the work available in one Member State, with effect in other Member States. The remuneration due to the right holder can be calculated in function of the exploitation value, taking into account *inter alia* the actual or potential public across the Member States where the work can be accessed.

For the **end-user/public** the variables on the making available right have no direct legal consequences. Under this construction the acts performed at the user's end are not restricted under the making available right (although the reproduction right continues to apply). Commercially, the end-user's position may be affected by the larger offer of online services or, inversely, the national offer due to contractual restrictions.

**Conclusion.** The uncertainty with regard to the author/initial ownership of the work may be solved by harmonising the rules at the European level. There are however few indications that this is a major problem in practice. Furthermore, the harmonisation of the national rules on authorship and initial ownership will not prevent an ulterior fragmentation of rights so there are different derived right owners with making available rights.

The **reproduction right** is autonomous of the right of making available in the sense that the use of a work may cumulatively involve acts of making available to the public and reproduction. In the scenario where the act of making available to the public is localised in a Member State of origin, the reproduction right may be exercised:

- Upstream: the work is reproduced on the server where the work is hosted for it to be accessible to the public.
- Downstream: the work being available to the public, reproductions may follow directly from this availability and occur at the end user's end. Some reproductions may be ephemeral and thus be exempted under the exception for temporary acts of reproduction (art. 5(1) InfoSoc Dir). Examples are the temporary copies made while consulting the work in order to view (television, computer, mobile device). Other reproductions are (more) permanent and cannot be exempted under this exception.

Both the upstream and the downstream copies may be protected reproductions that require the right holder's consent. These protected acts may occur outside the Member States where the making available is localised. Moreover, the person who holds the reproduction right is not necessarily the same person as the one holding the making available right (fragmentation of rights). The rights for the reproductions, made upstream and downstream, should therefore be cleared. Although the reproduction has been harmonised in the InfoSoc Directive, there remain national divergences with regard to the reproduction right, for example who bears the responsibility for clearing the reproduction right.

The **right holders'** consent is thus required for all uses that involve acts of making available and reproduction. These rights could be in the hands of distinct persons. It is not sufficient to acquire authorisation for making the work available in the Member State of origin, the consent is also required for acts of reproduction occurring outside the territory of making available.

This means that the **uploader**, who intends to make a work available to the public, should not only clear the making available right in the Member State where this act takes place, but also the reproduction right for the upstream copies and possibly also for the downstream copies, depending on the national law in this regard. This complicates the licensing process. In case the uploader has not acquired any authorisation, she could be found responsible for infringements of the making available right and the reproduction right.

The **end-user** who consults a work is likely to perform an act of reproduction. In most streaming cases the copy will be exempted under the exception for temporary acts of reproduction (art. 5(1) InfoSoc Dir). The scope of this exception is still uncertain, further clarity being expected in future decisions of the CJEU. Where a permanent copy is made, the author's consent is required and this burden may fall upon the end-user. The end-user may thus be at risk for example when a service provider makes works available to the public, the end-user receives the work directly from this service provider but the reproduction rights are not cleared for this end-user's reproduction. The end-user may rely on an exception to the reproduction right under national law. National divergences subsist concerning the application of national exceptions (most exceptions in the InfoSoc Directive being optional except for the one covering temporary acts of reproduction).

**Conclusion.** The reproduction right is not inseparably connected to the making available right. While the making available of a work to the public may be localised in one Member State, acts of reproduction may occur in the same Member State and outside this Member State, depending on where the copies are made and the work is reproduced. Where no exception applies, this reproduction should be authorised by the holder of the reproduction right (who may be another than the holder of the making available right) either on the account of the uploader (the reproduction following directly from the availability of the work to the public) or the end-user.

## B. Exploitation of the work

In this section, it will be analysed how the making available right would be applied when the exploitation of the work is emphasised. First it will be examined how the making available right can be localised in the Member State or Member States where the exploitation is taking place. The efforts of the uploader to target a public is considered a distinctive criterion, for which practical indications will be summed up based on the decisions of the CJEU (sub 1). Then the effects of such localisation criterion will be considered in terms of authorship and ownership of a work, the cumulative application with the reproduction right and enforcement (sub 2-4). A summary of the findings will be described in the intermediate conclusion (sub 5).

### 1. Principle

The making available of a work to the public can be localised in the Member State or Member States where the work is exploited. This localisation criterion results from the definition of the making available right as an act of exploitation. A work is made available to the public if it is uploaded and made accessible to a public in a way that makes it possible for the uploader to derive an economic benefit from the public accessing it. This does not mean that the uploader should actually pursue such benefit: it suffices that this form of communication makes it possible to “monetise” the public. The consequence is that the mere fact that a work is accessible does not automatically lead to finding an act of making available: there should be concrete indications that the uploader meant to organise the exploitation of the work.

It follows that the act of making available to the public can be localised in the Member States where such concrete indications are found of the uploader’s intentions to exploit the work on the territory of a given Member State. It is not sufficient that work is technically accessible from the territory of a Member State<sup>363</sup>, it must be established that the exploitation was directed to this Member State, the uploader had the intention of addressing the public in that Member State. Various and variable criteria could be applied to determine whether the exploitation takes place in a particular Member State: the content made available could be of mainly national interest, the language in which the service is offered, references to local events, the currency, payment methods, marketing and promotional techniques,... This does not mean that a work made available on a non-commercial basis should be assessed by different standards. Even if the uploader has no direct commercial purpose, her act of making available will be localised according to the location of exploitation, in particular the targeted public.

In some cases it will be clear that the public of one particular Member State is targeted, e.g. because it is stated explicitly or it is implied in the branding of a service (e.g. in the trade name of the service). In other cases, it will be more difficult to pinpoint one single Member State as the target of an uploader: she may address the public in several Member States (e.g. language groups) or not distinguish at all. In those cases the exploitation of the work will take place in several Member States, therefore acts of making available can be found in several Member States.

A similar drift can be found in the relevant decisions of the Court of Justice. In several cases the Court has sought evidence of the intention to **target** the public of a given Member State. Moreover, the Court has distilled several concrete elements that indicate that a work is targeted at a public in the territory of a certain Member State.

**Sportradar.** In *Sportradar*, the question was asked where the act of re-utilisation of a database, covered by the *sui generis* protection of Directive 96/9, took place: in the Member State where the web server is

---

363 In this sense : J.H. SPOOR, D.W.F. VERKADE, D.J.G. VISSER, *Auteursrecht*, Kluwer, 2005, 209. These authors consider that more than mere accessibility is required to find an act of « openbaarmaking » in the Netherlands, a sufficient connection to the Netherlands has to be established, e.g. the site is owned by a person established in the Netherlands or it is targeting (at least part of) the Dutch public.

located or in the Member State where the user is located to whose computer the data are sent. The Court first defined the restricted act as “*extending to any act, not authorised by the maker of the database protected by the sui generis right, of distribution to the public of the whole or part of the contents of the database*” and covering an act “*in which a person sends, by means of his web server, to another person’s computer, at that person’s request, data previously extracted from the content of a database protected by the sui generis right. By such a sending, that data is made available to a member of the public*”<sup>364</sup>. This act of sending is localised – at least – in the Member State “*where there is evidence from which it may be concluded that the act discloses an intention on the part of the person performing the act to target members of the public in [that Member State]*”<sup>365</sup>.

Relevant circumstances in this case were that the data in the database related to English football league matches<sup>366</sup>, contracts concluded with companies knowing that they offer betting services to the UK public, possibly a remuneration taking into account the activities of the betting companies in the UK market and the prospects of its website subsequently being consulted by internet users in the UK. Supporting evidence could be found in the circumstance that the services (in which the data are used) are offered in the language of the customers, which is not the language commonly used in the Member States from which Sportradar pursues its activities.

The Court in *Sportradar* referred often to its rulings in other cases that were more or less comparable.

**Pammer/Hotel Alpenhof.** In the joined case *Pammer/Hotel Alpenhof*, the Court was asked to find whether a trader (operating via the Internet) “directed its activity to the Member State of a consumer’s domicile” in order to establish jurisdiction<sup>367</sup>. The Court found that an intention to target one or more Member States was implicit in certain forms of advertising, such as traditional forms (press, radio, television, cinema, catalogues or offers in person), but not in others, such as the Internet advertisement. The mere fact that such Internet ads are accessible outside the Member State where the trader has its establishment does not entail that it is directed to other Member States. It had to be verified whether the trader has manifested its intention to establish commercial relations with consumers from one or more other Member States, including that of the consumer’s domicile<sup>368</sup>.

The Court listed non-exhaustively which factors could indicate that the trader’s activity was directed to the Member State of the consumer’s domicile: the international nature of the activity, mention of itineraries from other Member States for going to the place where the trader is established, use of a language or a currency other than the language or currency generally used in the Member State in which the trader is established with the possibility of making and confirming the reservation in that other language, mention of telephone numbers with an international code, outlay of expenditure on an internet referencing service in order to facilitate access to the trader’s site or that of its intermediary by consumers domiciled in other Member States, use of a top-level domain name other than that of the Member State in which the trader is established, and mention of an international clientele composed of customers domiciled in various Member States<sup>369</sup>. By contrast, the mere accessibility of the trader’s or the intermediary’s website in the Member State in which the consumer is domiciled is insufficient, as is the mention of an email address and of other contact details, or of use of a language or a currency which are the language and/or currency generally used in the Member State in which the trader is established<sup>370</sup>.

**eBay.** In *eBay*, the Court decided a case on the offer of goods via the online market place eBay. Some goods were counterfeits, the offer for sale of others entailed the use of a sign that could be an

---

364 Sportradar, par. 20-21.

365 Sportradar, par. 47.

366 Sportradar, par. 40.

367 Pammer/Alpenhof, par. 52.

368 Pammer/Alpenhof, par. 75.

369 Pammer/Alpenhof, par. 93.

370 Pammer/Alpenhof, par. 94.

infringement of exclusive trademark rights. The issue was whether the Community and/or national trade mark protection applied to the online offer for sale, since the goods were located in a third state or the person behind the offer was established in a third state. It was decided that (Community or national) trade mark protection applies “as soon as it is clear that the offer for sale of a trade-marked product located in a third State is targeted at consumers in the territory covered by the trade mark”<sup>371</sup>. The effectiveness of the trade mark protection would indeed be undermined if it did not apply to such use of a sign, directed at consumers in the EU, merely because the establishment of the person behind the offer or the advertisement, the hosting server for the website or the offered product offered for sale were located in a third State. It is however not sufficient that the website is merely *accessible* from the territory covered by the trade mark, to conclude that the offer for sale is targeted at the consumers in that territory. It is for the national court to assess “on a case-by-case basis whether relevant factors exist, on the basis of which it may be concluded that an offer for sale or an advertisement displayed on an online marketplace accessible from the territory covered by the trade mark is targeted at consumers in that territory”<sup>372</sup>. Any details of “the geographic areas to which the seller is willing to dispatch the product” on the website where the offer to sell is displayed are particularly important to assess whether the public in the territory (in this case the EU) are targeted.

**Donner.** In *Donner*, the issue was the localisation of the act of distribution to the public by sale. An Italian company sold replica furniture *inter alia* to the German public, this furniture at that time not being effectively protected under Italian copyright. The furniture was brought to customers in Germany via an Italian freight forwarding firm. The issue was whether the German person heading the freight forwarding firm could be criminally pursued in Germany for infringement of the distribution right. The Court of Justice answered the question by a description of the right of distribution to the public and by localising this (complex) act. The notion of distribution to the public (art. 4(1) InfoSoc Dir) was understood as “making available to the public through sale” (art. 6(1) WCT) and it was characterised by a series of acts, going from the conclusion of the sale contract to the delivery to a member of the public<sup>373</sup>. In case of a cross-border sale, consisting of several acts which may take place in different Member States, the distribution right may be infringed in a number of Member States. The Court found that, in complex operations involving different actors, a trader is responsible for acts carried out “by him or on his behalf”, but also for acts by a third party “where [the trader] specifically targeted the public of the State of destination and must have been aware of the actions of that third party”<sup>374</sup>.

Relevant factors were the existence of a website in German, the content and the distribution channels of the advertising materials, a cooperation with a freight forwarding company making deliveries in Germany and these could be taken as proving such targeted activity. It was stated, generally, that “a trader who directs his advertising at member of the public residing in a given Member State and creates or makes available to them a specific delivery system and payment method, or allows a third party to do so, thereby enabling those members of the public to receive delivery of copies of works protected by copyright in that same Member States, makes, in the Member State where the delivery takes place, a distribution to the public”<sup>375</sup>.

A caveat must be expressed, since these decisions each deal with a particular set of facts and are perhaps not to be generalised. At least in *Donner* and in *Sportradar* it was fairly straightforward which (national) public was targeted. In *Donner*, the specific advertisement system, the delivery and the payment methods were clearly directed to the German public. In *Sportradar*, the database was offered to betting companies directed to the UK market (the bets relating in particular to the football competitions of England and Scotland). The Advocate-General in *Pinckney* considers however that these principles may

---

371 L'Oréal, par. 61-62.

372 L'Oréal, par. 67.

373 Donner, par. 26.

374 Donner, par. 27.

375 Donner, par. 30.

apply in a case of (alleged) infringement of the rights of distribution and communication to the public via Internet<sup>376</sup>.

**Summary.** Yet an attempt can be made to distil some general guidelines from these cases. The Court generally applies a “targeting” criterion, meaning that it localises the restricted act in the Member State or Member States if the person performing the act has the intention of targeting the public in that Member State. It is not sufficient that a work is *accessible* in a Member State, to find that the public in that Member State is *targeted*.

The following criteria have been taken as indications of a targeting activity: content of the service of particular interest to the public in one Member State (national football competition), the terms of the contract (remuneration in function of the public), the willingness to dispatch goods in particular geographical areas, the presence of a specific delivery system, advertisement materials, a specific payment method.

Other criteria have circumstantial value, such as the language in which the service is offered or the currency in which it can be paid. The fact that the service is offered in a certain language is by itself not conclusive to a targeting activity. The circumstance that the service is presented in the language of the customers and that is different from the language commonly spoken in the Member State from where the service provider pursues its activities may indicate that the public of another Member State is targeted.

The Court’s approach in these cases is helpful for the approach developed under the “exploitation scenario”, where the act of making available is defined as an act of exploitation and is localised in the Member States where the exploitation takes place. In both cases the “public” is central: the uploader/service provider has the intention of reaching a public, which creates a possibility to monetise the works (directly or indirectly, actually or potentially).

This approach has advantages and disadvantages, depending on the point of view.

It corresponds to the exploitation approach to the making available right. If the making available right is understood as protecting a particular form of exploitation, then the territorial scope should correspond to this definition<sup>377</sup>.

It allows taking into account the geographic location of the public (territoriality principle) and the right holders have exclusive control over the exploitation of their works per Member State. This criterion reduces the risk of location shopping and the authors are less vulnerable to circumvention (pressure towards the country of lower protection). In case of fragmentation of rights, the act of making available requires the consent of person holding a right for one given territory, where the exploitation will take place and the effects of the making available will be felt. Inversely, this person will have the possibility to take legal action in case of infringement.

At the same time, this criterion relieves the uploader/service provider from the burden of acquiring the authors’ consent in all Member States where the work is merely accessible<sup>378</sup> (as far as the making available right is concerned). No restricted act takes place where the work is accessible, as long as the *exploitation* is covered by a licence (which takes due account of the public that actually has access).

The location of the exploitation (in contrast to mere accessibility) of the work may be established by variable and various criteria, which will appear and be weighed on a case-by-case basis. This has also been the method of the CJEU in the cases discussed above. This approach allows a certain flexibility to

---

376 Advocate-General in Pinckney, par. 64.

377 See on this point: Advocate-General in Pinckney, par. 63-64. The Advocate-General considered that the damage was caused where the public was found, since the author would suffer loss of income there (*lucrum cessans*).

378 See, on mere accessibility: L’Oréal, par. 64 in relation to trade mark protection, and Sportradar, par. 36 with regard to the re-utilisation right of databases. However, see *infra* the application of the reproduction right on the copies made at the end-user’s end in order to access a work.

each particular case (taking into account the choices made by the uploader/service provider and her/its efforts to “target” specific audiences).

The difficulty with this localisation criterion is its formulation in an abstract and generally applicable rule that offers enough clarity to be applied in practice.

Firstly, an all-encompassing definition of an “exploitation” of a work is difficult to fix. The objective criteria to define the concept of exploitation and the target of that exploitation have to be defined through a case-by-case approach. There is little or no legal certainty concerning the particular criteria to find a national exploitation. It appears from the cases decided by the CJEU that the criteria to find targeting activities are intrinsically connected to the facts of the case. A body of case law will be construed over time but before that time there is some legal uncertainty as to the Member States where acts of making available are performed.

The online exploitation of a work in several countries will lead to acts of making available in several Member States. Especially in case of a multi-territorial exploitation directed indiscriminately to a public spread over the territories of several or all Member States, there is no unique or decisive localisation factor. This is more the case when parts of the European public are addressed based on other criteria than purely national ones, e.g. an international news website offered in English or in several European languages. In that case the works are made available in several Member States, i.e. in each Member State where the exploitation is realised.

In cases where it would be impossible to localise the exploitation in one or several identified countries, then there is a risk that the act of making available would be considered to occur in all the countries where the work is accessible.

If there is a will for localisation of the protected act in one single country, then *de lege ferenda* a criterion should be found to choose one Member State of exploitation among the different Member States where an exploitation could be found. It seems however not practically feasible to select one Member State of exploitation if the exploitation is equally spread over several Member States without seeming arbitrary.

## 2. Conflict of laws

The impact of the exploitation scenario on the principles of private international law is limited. We will successively examine its effects on the issues of jurisdiction (sub a) and applicable law (sub b).

### a) Jurisdiction

In the exploitation scenario, the act of making available is localised in the Member States where the work is exploited, i.e. where the national public is targeted. In case of a purely national exploitation, the act of making available will be localised in that Member State. When the work is addressed to several national publics, to a Europe-wide public or to no national public in particular (e.g. the Pirate Bay), the exploitation takes place in several Member States and the act of making available is localised in several Member States.

The courts of any Member State can be seized for provisional measures, even if this is not the court that has jurisdiction on the merits. It is uncertain if the CJEU ruling *Solvay v Honeywell* (a patent case) applies for provisional cross border injunction in copyright.

On the merits, the courts of the place where the defendant is domiciled are competent. Moreover, the courts of the Member State where the harmful event occurred are also competent. It means that the courts of the place where the *event giving rise to the damage* – i.e. the courts of the Member State where the activation process was decided (where the user/uploader is established) – have jurisdiction with regard to the entire damage. Finally, the courts of the Member State where the damage occurs - namely the courts where the public targeted by the exploitation of the work – are also competent. Their jurisdiction is however limited to the damage occurring in their country. Even if the decision delivered in the case *Sportradar* – according to which “*the mere fact that the website containing the data is accessible in a*

*particular national territory is not a sufficient basis for concluding that the operator of the website is performing an act of re-utilisation (...) in that territory*<sup>379</sup> – could be applied to the making available right, it could be argued that the Courts of the Member States where the work is accessed also have jurisdiction, if a damage is suffered in that country, even if the exploitation of the work does not specifically target that country. In case of a transnational exploitation, it may be difficult for the seized court to rule on the entire damage: if the work is also exploited in other Member States, then the courts of those Member States are also competent to rule on the entire harm.

The connecting factor of the place of the centre of interests of the right holder, which was applied in the case of an infringement of a personality right, is not directly transposable to the case of the infringement of an economic right under copyright. Cessation measures on the merits can be claimed before the courts of the Member State where the defendant has her domicile/establishment (including intermediaries such as ISPs), where the harmful event has occurred (with cross-border effect) and where the damage is felt (national effect).

### **b) Applicable law**

In case of a purely national exploitation (possibly *de facto* enforced by technological measures), the act of making available is performed in one Member State<sup>380</sup>. An exploitation that addresses a wider public may by contrast be localised in several Member States, hence several laws may apply to one material act with effects in different Member States according to the *lex loci protectionis* (interpreted in favour of the laws of the countries of reception). However, it will not suffice that the work is accessible in a Member State to find that the act of making available takes place in that Member State (the so-called spill-over). This principle is in conformity with the *Sportradar* decision of the CJEU.

It could thus be imagined that a work is made available on a website turned to the German-speaking public. Depending on the circumstances of the case, acts of making available could be found in Germany and in Austria (e.g. a music website with national charts for both countries, references to regional music events, local artists, ...). The mere fact that the website is accessible to German-speakers in e.g. Belgium does not entail that the works are made available in Belgium. If two acts are localised in resp. Germany and Austria (where the targeted publics are present), the national copyright acts of Germany and Austria will apply to the infringement and to the measures available to enforce the national copyright acts. It can thus be imagined that one court is seized (in conformity with the principles of jurisdiction) which will then apply different national copyright laws to find the infringement, evaluate the damage or impose other measures (depending on the localisation of the restricted acts). This criterion suits well in those cases where a targeted national public can be identified – or a restricted number of publics. It is not so straightforward to identify the applicable law in case of pan-European or even global service (e.g. global news websites in several languages): where no clearly targeted public can be identified, it could seem arbitrary to localise the service in one Member State or in some selected Member States.

## **3. Authorship, ownership and transfer of rights**

The authorship of copyright protected works is only partially harmonised at the European level. The Member States are competent to determine authorship of works that are not subject to a European directive (such as computer programs, databases or audiovisual works). All Member States under consideration adopt the “creator doctrine” to some extent. There are however important differences, in particular with regard to collective works, works created by an employee in the context of her employment and even audiovisual works (although the effects are mitigated by the presumed transfer of rights in favour of the producer). Moreover, the issue of copyright contracts has not been harmonised at all, which results in important disparities between the national copyright laws. Some Member States barely regulate

---

379 *Sportradar*, par. 36.

380 Abstraction made of access without consent outside this territory and the resulting reproductions.



the contracts on the exploitation of copyright works, other Member States impose more or less detailed conditions for the validity, interpretation or enforcement of copyright contracts.

These disparities are likely to have an impact on the position of the right holders when applied to a making available right that is localised in one single Member State.

The making available right is understood in this section as an act of exploitation, localised in the Member State or Member States where the exploitation takes place, i.e. where the public is targeted. One or several acts of making available can thus be identified and localised in one or several Member States.

This may have repercussions on the determination of authorship, ownership and the transfer of rights rules.

### a) Authorship and initial ownership

**Authorship and initial ownership.** This entails that the authorship or initial ownership is determined in accordance with the laws of the Member State where the act of making available takes place. By consequence, it affects the acquisition of licences and right to take legal action in case of infringement.

If a work is made available to the public in one Member State because it appears clearly from all circumstances that the public of one Member State is targeted, the exploitation takes place in that Member State. Depending on the choice of the law applicable to determine the authorship/initial ownership (*lex loci originis* or *lex loci protectionis*), the author or initial right owner might be determined in accordance with the rules in the Member State of exploitation. If the exploitation takes place in several Member States, distinct acts of making available are performed in those Member States where the public is addressed. The case could be that a service is directed at all members of the public of the EU (e.g. content that could be of interest to everyone, accessible in a language commonly understood in all Member States) or that a service is directed at the public in a smaller number of Member States (e.g. where the public shares a certain cultural interest or – often related – language). The application of the principles *lex loci protectionis* and *lex loci originis* are successively analysed hereunder in order to show the different outcomes they would provide.

**Lex loci protectionis.** The *lex loci protectionis* may refer to the law of the country of transmission or to the laws of the countries of reception (Member States of exploitation).

In the second hypothesis, the uploader/service provider who intends to make a work available on the internet will have to comply with the law applicable in each country she/it targets. Doing so, they will have to determine the owner(s) of the rights according to the law of each country targeted. In some situations, different persons will have to grant their authorisation (cumulatively) for the overall exploitation of a work on internet.

For example, a news aggregator that makes news articles (already published online) available to the public needs to clear the right of making available to the public. Leaving aside the contractual assignment for now, this aggregator needs to obtain the authorisation of the journalist (creator) or the publisher (employer or initiator of a collective work). This depends on where the act of making available was performed. If the news aggregator targets the publics of several Member States, then the consent for each Member State must be acquired (since distinct acts of exploitation and therefore making available are established). If these Member States consider the same person as the author/initial right owner, then one contract can cover the entire exploitation. If different persons are identified as the author/initial right holder of the work, then separate contracts will have to be concluded per territory (e.g. the journalist/author or the publisher/employer/initiator of a collective work<sup>381</sup>).

---

381 We assume this is a theoretical problem. As a practical matter, the publisher will probably already have obtained these assignments.

Inversely, in case of infringement, it is either the journalist or the publisher who can take legal action and claim cessation or damages from the news aggregator. Again, who can initiate the legal action depends on where the work was made available. The uploader/service provider does not have to clear the making available rights for all the territories where the work is accessible. In principle the potential number of national laws governing the act of making available is reduced: only the law of the countries targeted by the act of exploitation would apply instead of the law of each country where the work is accessible.

In that context, the harmonization of the rules on the determination of authorship would of course simplify the users or service providers' activities. In the absence of harmonisation, the situation would be significantly similar to the one that currently rules the Internal Market.

**Lex loci originis.** By contrast, if the *lex loci originis* principle is applied to determine the authorship of a work, then the initial right holder is invariable (*supra sub C.2*), regardless of where the act of making available is localised. According to the principle of *lex loci originis*, the initial owner of copyright is determined in accordance with the law of the country of origin of the work (not the origin of the making available), i.e. the country of the first publication of the work or, in case of unpublished works, the country of which the author is a national (art. 5(4) BC). In that case, the same person holds the making available right, regardless of where the act of making available to the public is performed.

Under the *lex loci originis*, the initial right holder is invariable, regardless of the interpretation of the making available right and regardless of where an act of making available is localised. The initial owner of copyright would thus remain the same person wherever the country where the work is then exploited.

Once this person identified, the licence contract between the right holder and the uploader/service provider would be governed by the law of the contract (*infra*). Inversely, the author identified according to the copyright law in the country of first publication of the work has the right to claim infringement of her right, if her work is made available without her consent (unless she has transferred her rights to a third party).

In case the *lex loci originis* is applied, the need to harmonise at the European level the rules on the determination of authorship appears to be limited. Still it would be a cumbersome task to clear the rights, especially for service providers offering a wide range of works (such as automated aggregators or music providers). Practically, the need to harmonise the rules on authorship and initial ownership should be assessed taking into consideration the contractual practices in the different sectors. If it appears that (in some sectors) the rights are transferred by contract to one person or a limited number of people, then the need to harmonise the (preceding stage) of authorship or initial ownership is not so pressing. This assessment is however beyond the scope of this Study.

## b) Transfer of rights

**Transfer of rights.** As far as the transfer of rights is concerned, a distinction has to be made between contracts operating a transfer of rights concluded *prior* to the making available of the work, and contracts expressly concluded to give an authorisation for the making available of the work ("contracts with the purpose of the making available of the work").

**Preceding transfer of rights – derived ownership.** We have described how the uploader/service provider should proceed to determine the author or initial right owner of a work she intends to make available to the public. However, in many cases the uploader/service provider will be confronted with a derived right holder, rather than the author/creator. It is common for authors to entrust the exploitation of their works to a publisher, record label, film producer, collecting society,... The uploader/service provider should then conclude a contract for the exploitation of the work with the person actually holding the right of making available to the public. She has no option but to respect the existing contracts between the author/initial right owner and the derived right holder. It matters not where the intended act of making available will take place: the location of the restricted act does not have an influence on who has acquired those rights from the author/initial right owner.

Consequently, if a contractual transfer of the rights in a work has occurred, the uploader or the service provider who intends to make that work available should acquire the rights in conformity with the contractual arrangements of the author or initial right owner. The location of the intended act of making available as such will not lead to variable right holders by virtue of the national copyright rules, since the existing contracts determine which party holds the relevant making available right. By contrast, it may matter where the making available takes place in case the making available rights have been granted to different parties per national territory (territorial fragmentation). It should then be determined in which Member State the intended act of making the work available to the public will be situated, in order to determine which party holds the (exclusive) rights to this territory and who can grant a licence to the candidate uploader.

Similarly, if the work is made available by a user or a service provider without prior consent of the rights holder, the person having acquired the rights in execution of that copyright contract will be entitled to claim compensation.

**Contract operating transfer of making available right.** If the act of making available is localised in the Member State(s) where the exploitation takes place, then the rights should be cleared for all those Member States (restricted act). It should then be determined which law is applicable to the contract in which the licence for the making available (per Member State) is granted. This means that one act of exploitation, directed at several Member States, could entail an act of making available in these Member States and that the person holding the rights for each of those Member States should authorise this exploitation (per Member State). This is not so much of a practical problem for the uploader/service provider if all rights are held by one person (possibly a derived right holder). By contrast, if the rights of making available are (territorially) fragmented and held by different persons, then the uploader/service provider should acquire the consent from the person who holds the rights for the Member State where an exploitation of the works can be found.

The application of a criterion of localisation to the making available right could have a consequence in the determination of the law applicable to the contracts operating the transfer of rights on works with the purpose to make them available on internet. In the absence of a choice made by the contracting parties, the law applicable to these contracts would necessarily be the law applicable in the country where the act is deemed to occur.

Concerning the transfers of rights, the localisation of the protected act at the place of exploitation of the work leaves the question open for the determination of the law applicable to contracts operating the transfer of the rights on works exploited in several countries (contracts concluded “with the purpose” of the making available of the work), provided that the contract does not specify the applicable law. It may however matter that a restricted act is found in each country where a national public is targeted: this may influence the determination of the state to which the contract is most closely connected or of where the characteristic obligation should be performed.

#### 4. Reproduction right

**Summary.** It has been found that the right of making a work available to the public and the reproduction right apply cumulatively to the use of a work. The reproduction right is currently understood in a technical way, which means in practice that a reproduction in the technical sense, a “copy”, is equated to a reproduction in the legal sense. The scope of protection of this economic right is limited by the mandatory exception for temporary acts of reproduction (art. 5(1) InfoSoc Dir). Despite several decisions of the CJEU, the overall scope of protection of the reproduction right is uncertain, especially in the light of non-permanent copies at the end-user’s end (e.g. streaming or browsing).

Reproductions have been identified “upstream” and “downstream” in the average online on-demand use, i.e. on the server where the work is hosted for transmission and at the user’s end, after transmission on demand (leaving aside copies in the course of the transmission via a network).

The reproduction right being applied cumulatively to the same processes as the making available right, an additional burden may be imposed upon the person who wants to clear the relevant rights to offer a service (the reproduction right and the making available right as a species of the right of communication to the public are not necessarily held by the same persons). Also, it may increase the number of interested parties in case of an infringement.

Having defined the making available to the public as a material act of upload that is localised in one Member State (where the uploader has her centre of interest or has performed the act of upload), it should be verified whether the location of the **upstream reproduction** coincides with the Member State where the work is made available. The same should be done for the **downstream reproductions**, including for the copies made when an end-user actually accesses or receives a work. Some temporary copies for viewing a work will be exempted but more permanent reproductions will require the author's consent, wherever the act of reproduction is performed and even outside the territorial scope of the making available right.

In this section, the making available right has been approached in a more economical way, centred on the exploitation of the work. The restricted act of making available is localised **where the exploitation takes place, in particular where the public is targeted**. An exploitation may cover several Member States, but the mere accessibility of a work in a Member State does not suffice to find a restricted act in that Member State.

The reproductions do not necessarily take place in the same Member States as the making available of the work. In many instances reproductions of the work will occur in the Member State where the work is being exploited (and where the making available takes place) but this is not necessarily the case.

- The “upstream” reproduction (on the server where the publicly available work is hosted) takes place in the Member State where the reproduction is made.

This may well be in the Member State where the work is made available (exploitation), but this is not necessarily the case. The reproduction right is indeed determined according to technical criteria, which are not pertinent to the making available right (understood as an act of exploitation). It is more than plausible that the upstream reproduction takes place in one Member State (where the hosting server is located or where the material act of upload has taken place) but the exploitation by making available is oriented to other Member States (where the public is targeted). It should be remembered that the Member States are free to determine the criteria to localise a reproduction and who made it.

- The “downstream” reproductions (i.e. downloads and those access copies that are not covered by the exception for temporary acts of reproduction) are made at the end-user's end.

The download or access by a member of the targeted public, as a direct consequence of the work being made available to the public, will give rise to a reproduction.

When a member of the targeted public makes the reproduction, then the reproduction takes place in the same Member State as the act of making the work available to the public (of that Member State). When the work is reproduced in a Member State where the public has access but is not specifically targeted by the uploader/service provider, an act of reproduction may occur outside the Member State where the act of making available takes place.

A number of factors may complicate the picture. Firstly, the reproduction right and the right of making available are in different hands. Secondly, Member States may have different rules for determining who has the burden of clearing the reproduction rights (the uploader/service provider and/or the person making the reproduction at the end-user's end). It should also be reminded that the Member States are free to determine the localisation criteria for the reproduction right. This may play a role in times of cloud computing, where the final user does not store her copies in her proximity (but under her virtual control) and where the role of technical intermediaries is more important.

In the simplest scenario, the rights of reproduction and making available are held by one and the same person and the rights for the reproductions at the end-user's end can be cleared by the uploader/service provider. It is more complicated when the making available right and the reproduction rights are (territorially) fragmented, so the making available right should be cleared for all the Member States where the uploader/service provider intends to exploit the work by a contract with the persons holding the rights to those territories. In addition, the uploader/service provider should acquire the reproduction right for all those territories where a reproduction is expected from the holders of the reproduction right per territory. In addition to these rights, reproductions may occur in the Member States where the work is accessible, but the public of that Member State was not targeted as such (no act of making available). The uploader/service provider and/or the end-user accessing the work are at risk of copyright infringement. This could be the case, e.g. when a member of the targeted public accesses a work when she is "abroad" (e.g. "expat" communities or business trip). This is the result of the technical interpretation that is currently given to the reproduction right.

In addition to the acts of making available in the Member States of exploitation, several reproductions may take place, "upstream" and "downstream". If the work is accessible in other Member States than where the public is explicitly targeted, then it is likely that a reproduction will be made in those Member States. With a lack of harmonisation of the localisation criteria and the exceptions, it should be verified in which Member State the reproductions are made, who is responsible for the reproduction and whether the author's consent is required.

We have found here that the reproduction right is approached in a merely technical way and that the scope of the reproduction right (in combination with the exception for temporary acts of reproduction) is uncertain. The rights of reproduction and making available being autonomous rights that can be applied cumulatively to the same use of a work, the net copyright protection may be reinforced. Since reproductions can be found both upstream and downstream of the act of making available, the reproduction right may undermine any definition and localisation of the making available right. A consistent approach to the reproduction right and the making available right could be sought to solve this issue (either by reviewing the reproduction right or by defining the relation between both exploitation rights).

## 5. Intermediate conclusion

In this section we have examined the approach of the making available right, understood as an act of exploitation and localised in the Member State or Member States where an exploitation of the work takes place. The mere circumstance that a work is accessible is not sufficient to find an act of making available. The localisation criterion in practice can be understood as the targeting or the intention to target a public of a Member State. Indications of such targeting efforts can be found in the existing body of decisions of the CJEU: content of the service of particular interest to the public in one Member State (national football competition), the terms of the contract (remuneration in function of the public), the willingness to dispatch goods in particular geographical areas, the presence of a specific delivery system, advertisement materials, a specific payment method. Indications with circumstantial proof are the language in which the service is offered and the accepted currency.

This entails that when a work is exploited in several Member States (i.e. it is accessible on demand of the user and the user is part of the public the uploader intends to address), several acts of making available can be found in those Member States (where the public is targeted).

These principles pose few difficulties in a purely national situation, when a work is made available on demand to the end-user by an uploader/service provider in the same Member State and interested members of the public outside this Member State have no access to the work. This may be the case for "video on demand" offered by digital television service providers with national distribution networks. By contrast, if the work is accessible on demand to a larger public, the act of making available should be identified (the exploitation of the work being turned towards a general or a more circumscribed public) and localised (possibly in several Member States), while being distinguished from the mere accessibility that

does not result in a distinct act of making available to the public. This means that where a work is offered on demand of the public of two Member States (e.g. an e-book platform mirroring the distribution channels of the hard copy, including promotion in certain Member States with a common language), one act of exploitation is directed at two national publics and an act of making available can be found in each Member State.

**Conflict of laws.** The impact of the exploitation scenario on the issues of private international law is limited. It does not affect the application of the rules on jurisdictions: the courts of the Member State where the defendant is domiciled and, in case of infringement, the courts of the Member State where the event giving rise to the infringement took place and the courts of the Member State where the damage occurs remain competent.

As to the applicable law, the *lex loci protectionis* could lead to the cumulative application of the law(s) of the Member State(s) where the work is exploited (provided that the *lex loci protectionis* is interpreted in favour of the countries of reception). This could clarify the issues on applicable law and eventually limit the number of copyright legislation to take into account.

The **author/right holder** has several possibilities to litigate in case of infringement. She can claim provisional measures before the courts of all Member States of the EU, even if those courts are not competent on the merits. It could be argued that a provisional cross-border injunction is available as long as the court does not issue a final ruling on the copyright protection and the protection is not seriously challenged. She can seize the courts of the Member State of domicile/establishment of the defendant or where the event giving rise to the infringement occurred, for the reparation of the entire damage. The amount of this damage will be calculated by reference to the laws applicable in the Member States of exploitation. Cessation measures on the merits can be granted by this court, which will apply the law of the Member State for which protection is claimed, i.e. where the effect is sought. The author/right holder can also bring legal actions before the courts where the damage is felt. These courts are competent to state on the damage on that territory, applying its own law as the *lex loci protectionis*, interpreted as the law of the Member State of exploitation,

The **uploader/alleged infringer** can be brought before the courts of the Member State where she has her domicile/establishment or where she has performed the act of upload, in addition to all other Member States where provisional measures can be claimed. Furthermore, she can be expected to defend her case before the courts where the work is exploited, i.e. where the public is targeted. The uploader/alleged infringer can thus *de facto* influence which courts are competent to hear the case.

**Author/initial right owner.** The rules on authorship/initial ownership are not entirely harmonised at the European level. These may have an impact on who is entitled to grant authorisation or who has the quality to take legal action in case of infringement. All Member States see the creator of a work as its author to a certain extent but some have specific rules for collective work, works made by an employee in the context of her employment contract or provide presumed transfers of rights in favour of other persons than the author/creator. Different persons may thus be indicated as the author or initial right holder, depending on the Member State where the work is made available to the public.

*Lex loci protectionis.* Where the on demand exploitation of the work is oriented to the public in different Member States, distinct acts of making available are performed in distinct Member States. The national rules on authorship and initial ownership may diverge and may apply cumulatively, so several “initial right holders” may intervene for overall exploitation (e.g. via the Internet). Similarly, different persons may have the quality to bring legal action in one Member State where they are considered authors/initial owners.

*Lex loci originis.* If the authorship/initial ownership is determined according to this principle, the same person is invariably considered the author/initial owner of the making available right. Without subsequent contractual assignments, this single person can grant licences for the overall exploitation of the work, even if this results in acts of making available in several Member States.

**Transfer of rights.** The preceding transfer of rights by the author/initial owner to a derived right holder is not affected by the localisation in the Member States of exploitation. If the preceding assignments have resulted in a (territorial) fragmentation of rights, then the person holding the rights for the relevant territory of exploitation should be identified (either for licensing or enforcement purposes). An on demand exploitation that is directed to the public of several Member States can thus result in acts of making available in distinct Member States and require the consent of different right holders in different Member States.

The localisation in the Member State of exploitation (targeted Member State) leads to the following situation for the following stakeholders.

The **right holder** can grant a licence for the Member State where the exploitation takes place. Her rights in any given territory will not be undermined by right holders in other Member States: if the public in the Member State for which she holds the making available right is targeted, then her prior authorisation is required. It matters not where the uploader performed the material act of upload or where its centre of activities is situated, the value of the making available right is not affected by manoeuvres of the uploader.

Right holders may use contractual constructions to restrict the exploitation of the work to national territories, thus requiring uploaders/service providers to make a work available in one Member State and to restrict access to the work to users being present on the territory of that Member State (i.e. excluding access from outside the Member State). Such practices may constitute an infringement on the freedom to provide services within the EU or competition law. Such restrictions may however be justified by demonstrating that these are necessary to protect the essential subject matter of copyright protection (the equitable remuneration being payable per Member State where the exploitation takes place).

Inversely, the person making the work available, i.e. the **uploader**, who may be a private person or a (commercial) service provider, should obtain the right holder's consent prior to making the work available to the public. Her act of making available may be in several Member States, where she should clear this making available right. This means that the uploader should identify author, initial or derived right holder(s) in the MS where the making available takes place.

- **Author or initial right owner.** Since there is no harmonisation in this field, the copyright laws of the Member States consider different people the author or initial owner of the making available right. The uploader's task may be complicated since the consent of these different people may be cumulatively required to cover the overall exploitation taking place in several Member States.
- **Derived ownership.** The making available right may be transferred by contract to a third party. The uploader has the burden of identifying who holds the rights for the relevant territory. In case of territorial fragmentation the making available right should be cleared from different people (cumulatively) to cover the overall exploitation taking place in several Member States.

The rights have to be cleared per Member State where the exploitation takes place, i.e. where the public of that Member State is targeted. The remuneration owed to the right holder can be calculated in function of the exploitation value per Member State.

For the **end-user/public** the variables on the making available right have no direct legal consequences. Under this construction the acts performed at the user's end are not restricted under the making available right (although the reproduction right continues to apply). Commercially, the end-user's position may be affected by the larger offer of online services or, inversely, the national offer due to contractual restrictions.

**Conclusion.** The uncertainty with regard to the author/initial ownership of the work may be solved by harmonising the rules at the European level. If the same person is designated as the author/initial right holder (even in case of collective works or employment), it should be less complicated to conclude a licensing agreement. In case of exploitations covering several Member States, the same person could authorise making her work available in those Member States. There are however few indications that this divergence of authorship/ownership rules is a major problem in practice. Furthermore, the harmonisation

of the national rules on authorship and initial ownership will not prevent an ulterior fragmentation of rights as a result of contractual practices to this effect.

The **reproduction right** is an autonomous right, independent from the right of making available: the use of a work may cumulatively involve acts of making available to the public and reproduction. The reproduction right and the exception for temporary acts of reproduction are harmonised, yet the localisation criteria and the liability rules are not. The reproduction right may apply in addition to the making available right:

- Upstream: the work is reproduced on the server where the work is hosted for it to be accessible to the public.
- Downstream: the work being available to the public, reproductions may follow directly from this availability and occur at the end user's end. Some reproductions may be ephemeral and thus be exempted under the exception for temporary acts of reproduction (art. 5(1) InfoSoc Dir). Examples are the temporary copies made while consulting the work in order to view (television, computer, mobile device). Other reproductions are (more) permanent and cannot be exempted under this exception.

Both the upstream and the downstream copies may be protected reproductions that require the right holder's consent. These protected acts may occur outside the Member States where the making available is localised. Moreover, the person who holds the reproduction right is not necessarily the same person as the one holding the making available right (fragmentation of rights). The rights for the reproductions, made upstream and downstream, should therefore be cleared.

This means that the **uploader** should clear the making available right in the targeted Member State and the reproduction right for the foreseeable reproductions (upstream and downstream). It can be expected that reproductions will be made at the end-user's end in the Member State where the public is targeted. If the rights of reproduction and making available are held by different persons, then the consent of both should be obtained. The uploader may be at risk when the work is reproduced in a Member State where the public is not targeted in terms of the on demand availability. This is less foreseeable for the uploader, yet she may incur responsibility for the end-user's reproduction if the national law holds intermediaries responsible for such reproductions.

The **right holders'** consent is required for all uses that involve acts of making available and reproduction. These rights could be in the hands of distinct persons. By principle the reproduction right can be exercised when a reproduction is made in a Member State where the work is merely accessible (without exploitation directed to the public in that Member State). Depending on the national law, the end-user making the reproduction or the intermediary enabling this reproduction can be held liable.

The **end-user** who consults a work is likely to perform an act of reproduction. In most streaming cases the copy will be exempted under the exception for temporary acts of reproduction (art. 5(1) InfoSoc Dir). The scope of this exception is still uncertain, further clarity being expected in future decisions of the CJEU. Where a permanent copy is made, the author's consent is required and this burden may fall upon the end-user. The end-user may thus be at risk for example when a service provider makes works available to the public, the end-user receives the work directly from this service provider but the reproduction rights are not cleared for this end-user's reproduction. The end-user may rely on an exception to the reproduction right under national law. National divergences subsist concerning the application of national exceptions (most exceptions in the InfoSoc Directive being optional except for the one covering temporary acts of reproduction).

**Conclusion.** The reproduction right is not inseparably connected to the making available right. While the making available of a work to the public may be localised in one Member State (or several Member States), acts of reproduction may occur in the same Member State(s) and outside this Member State(s), depending on where the copies are made and the work is reproduced. Where no exception applies, this reproduction should be authorised by the holder of the reproduction right (who may be another than the holder of the making available right) either on the account of the uploader (the reproduction following directly from the availability of the work to the public) or the end-user.



### III. Conclusions

#### A. Status quo

In the first part of the Study, we have examined the right of making available in its current state and the territoriality principle (application and criteria). This has led to the identification of some bottlenecks.

The making available of a work to the public was described as a complex act, without precise definition, neither in the Information Society Directive nor in the 1996 WIPO Treaties in which the Directive has its origin: it is not entirely clear which material acts are protected as constitutive elements of the legal act of making available to the public.

In order to clarify its contours, the making available right was examined as a species of the genus right of communication to the public and contrasted to the distribution right in the InfoSoc Directive. The court decisions issued in 11 Member States have been examined to verify how the making available right has been applied to various online services.

The making available right requires (i) the availability of the work (ii) to the public (ii) on demand of members of the public. The starting point of the making available right is the **availability** (preceding the transmission on demand of the member of the public). It should however immediately be verified whether the public has access to the work. It is not sufficient to demonstrate that a work is stored on a server, without verifying that additional initiatives have been taken to grant access to the members of the public (e.g. by publishing a hyperlink leading to the location where the work is stored). The work may be available for download or streaming. So far the endpoint of the making available right, has, by contrast, not been addressed in national decisions (transmission resulting from a demand of a member of the public or reception by the member of the public). Members of the “**public**” should have access to the work on their demand. Insofar as the “public” is a notion common to all species of the genus right of communication to the public, the interpretations of the “public” by the CJEU can be extended to the making available right, which then requires an “indeterminate number of viewers”, by contrast to a “private group”, who are to some extent targeted by the “communicator” and receptive to the communication, rather than being merely caught by chance. Few cases have considered the “**on demand**” aspect of the making available right, although this distinguishes the making available right from other forms of communication, in particular the broadcasting right.

Next, the **territoriality principle** was examined. The principle that the national legislator is competent to regulate events occurring on the national territory in copyright terms has not been challenged, even after several international and European initiatives to harmonise copyright protection. This principle is confirmed in several CJEU decisions (*Lagardère*, *Stichting de Thuiskopie*, *Donner*, *Sportradar*). However, various **criteria** have been applied to trigger the “territoriality”. The Court paid attention to different factors, from a technical act (the presence of a ground station) in *Lagardère*, to the occurrence of harm on a territory, at the residence of the final user who causes the harm that located the conduct on the territory of a Member State in *Stichting De Thuiskopie* and the criterion of “intended target” of the distributor of the protected subject matter in *Donner* and *Sportradar*.

**Uncertainty re making available right.** The absence of a definition of the making available right creates some legal uncertainty as to the territorial reach of the online accessibility of protected subject matter. Different elements of this complex act could be considered relevant to establish the application of the national right of making available to the public: the availability on a server or the transmission to a Member State, even accessibility of the work has not explicitly been ruled out as a relevant element for the making available right. Consequently if all Member States are free to determine which element of the complex act is relevant to establish an act of making available, then each could subject this constitutive part to the prior authorisation of the author (and to the corresponding payment of a licence fee). The Member States could define the same or different criteria to apply their national making available right. At least in theory, this would lead to the accumulation of distinct acts of making available under the national copyright legislations concerned that do not necessarily correspond to the same technical and/or economic criteria. Without a clarification of this restricted act, its relation to the other exclusive economic

rights and the localisation criterion, it remains speculative which facts will trigger an infringement and in which Member State.

Finally, at the request of the European Commission, three legal issues have been examined in the Member States under consideration. It was described which conflict of laws rules apply to determine the competent courts and the applicable law. It was found that considerable divergences exist with regard to the national rules on authorship and initial ownership (in case of collective works, works made in the context of an employment relation or audiovisual works). Independently of these national rules, the making available rights may be fragmented as a consequence of contractual practices. Finally the making available right can be exercised in addition to the reproduction right, which is harmonised at the European level.

**Bottlenecks.** The current situation presents different bottlenecks, depending on whether the acquisition of a licence or an infringement of the making available right is concerned.

- **Licences and transfer of the making available right by contract.**

**Authorship and initial ownership.** Before concluding a contract on the online exploitation of a work, the right holder should be identified. There is controversy on whether the author/right holder should be determined by reference to the *lex loci protectionis* or the *lex loci originis* of the work. If the French Cour de cassation is followed and the author or initial owner is determined according to the *lex loci protectionis*, then the lack of harmonisation and divergence of national rules may lead, in theory, to conflicts between different persons (individuals or legal entities) who are considered authors or initial owners of the copyright under different national laws. If there is a multitude of acts in several Member States at the same time for each material act of upload leading to public accessibility, this means that the consent of several persons in different Member States is required.

**Fragmented ownership.** The exclusive rights under copyright can be transferred or licensed on a territorial basis. Different people then hold the rights of making available to a particular work for a certain territory. An act of making available with constitutive elements in different Member States should then be authorised by the persons holding rights for these distinct Member States, which may be a burdensome task for the uploader/service provider. Alternative mechanisms have been developed to facilitate the licensing process (e.g. multi-territorial licences, granted by one collecting society for its own repertoire and the repertoire of other collecting societies).

**Conflict of laws.** If a cross-border on demand offer is analysed as an act of making available with constitutive elements in different Member States, then the rights for each relevant act must be cleared by the service provider or the uploader. Once the right holder for the relevant territories are identified, it should be determined which law applies to the contract according to the principles defined in the Regulation Rome I. It is common for the contracting parties to explicitly stipulate the applicable law. In absence of such choice, the applicable law will depend on the qualification of the contract as a sale of goods, the provision of services, distribution contract or any other type of contract and the connecting factors. This law will govern issues related to the contract (validity, formalities, scope, interpretation, performance).

**Reproduction right.** The cumulative application of the making available right and the reproduction right may complicate the licensing of works for online use. Each act of making available entails (in the current state of technology and law) several reproductions. The rights should be cleared both “upstream” (hosting server) and downstream (e.g. at the end-user’s side) of the online availability. These reproductions may take place in yet other Member States than the relevant acts pertaining to the making available of the work. Since the reproduction right is autonomous and independent from the right of making the work available to the public, it may be held by a different person. Furthermore the burden for clearing the rights may be distributed differently in the Member States (end-user v service providers). The licensing process may be complicated by the circumstances that the rights of making available and reproduction may have to be cleared in different Member States and may be held by different persons. Moreover, it should be determined who has the responsibility, under the applicable national law, to clear the reproduction rights for the copies of the work at the end-user’s end.

- **Enforcement in case of infringement.**

**Conflict of laws.** The issues of private international law, and especially the questions of jurisdiction, are solved on the basis of factual elements.

The right holder can choose where to bring her legal action, depending on her objectives. Provisional measures can be obtained in all Member States, regardless of which court is competent on the merits, provided that there is some connection to the territory of that State. It is uncertain whether the CJEU's ruling in *Solvay v Honeywell* (a patent case) can be extended to the making available right and courts can issue cross-border provisional measures. On the merits the right holder can claim reparation of her entire damage in the Member State where the defendant has her domicile or where the harmful event occurred. This court will have to apply the *lex loci protectionis*, which means that it may be led to apply the laws of different Member States. The right holder can also act in other Member States where she has suffered prejudice, but the courts of those Member States will be competent only to rule on the damage occurring on the territory of their own Member States, in accordance with their own national law (the *lex loci protectionis* being the law of the Member State for which damages are claimed). Cessation measures on the merits can be claimed before the courts that have jurisdiction, i.e. where the defendant has her establishment, where the harmful event occurs or where the damage is felt. In some cases these criteria point to the same Member States, e.g. when an Internet access provider is asked to block access to platforms that are commonly used to make works available to the public on a massive scale without the right holders' consent.

**Authorship/ownership.** The rules on authorship and initial ownership differ from one Member State to the other, which means that different persons may hold the making available right in different Member States. Moreover, the making available right may be fragmented by contract. The holder of the making available right should be identified per territory where an infringement of this right may be found.

**Reproduction right.** An infringement of the making available right often goes together with an infringement of the reproduction right. Given the autonomy of both rights, it should however be verified for each case whether an act of reproduction is performed, whether this act required the right holder's consent or if an exception applies to the act of reproduction. Furthermore it should be verified where the act of reproduction takes place and who can be held responsible for the infringement under national law. Depending on the (territorial and material) fragmentation of rights, the persons who can claim infringement of the making available right and the reproduction right may not be the same. An infringement of each right must be established (in accordance with national law), damages may be awarded or other enforcement measures may be taken.

For the right holders, the independence of the making available and the reproductions rights means that they have an additional legal ground to demonstrate an infringement in case of unauthorised use. Where the rights are held by different persons, it should be verified whether the unauthorised use under consideration entails both acts of making available and reproduction and if the right claimant is involved in the litigation. The (alleged) infringer may thus have to face several right holders, claiming infringements and demanding measures (including cessation and cumulative damages).

## **B. Alternative approaches**

In the second part of this Study, two alternative approaches to the making available right have been studied. Two **caveats** have been expressed in this respect. Firstly, a modification of the application of the making available right should be decided in function of clear policy objectives. Only if the policy objectives are unambiguously stated can the efficiency of an alternative approach be assessed. Secondly, any such modification should take into account that the making available right is currently considered a species of the right of communication to the public hence any characteristics that are contradictory to this genus right should be avoided.

- **“Country of origin”**

The first alternative that was examined was a construction that allows localising the act of making a work available to the public in one single Member State (“**country of origin” principle**). The restricted act was defined as the material act of upload that leads to the work being available to the public. The localisation criterion could be either the centre of activities of the uploader (establishment, domicile or habitual residence) or the material act of upload. Both criteria could be combined, in order to solve some practical objections. The localisation criterion “act of upload” may be difficult to apply to legal entities with complex, international organisation structures so this criterion could be complemented by a fiction for legal entities that all acts of upload take place at the establishment of the legal entity.

A “country of origin” approach does not alter the **conflict of law rules** (unless it is actually intended as a rule to determine the applicable law). Several courts may have competence to rule in a dispute with cross-border elements. For provisional (protective) measures, the courts of any Member State may be seized provided that the intended measure has an effect on the territory of that Member State. On the merits, the competence of the courts depends on the measure claimed. A ruling on the entire damage can be expected from the courts of the Member State of the harmful event (e.g. where the uploader has its establishment or where the act of upload has taken place) or where the defendant has her domicile/establishment. These locations correspond to the “country of origin”. In addition, the courts of the countries where damage occurs are competent to state on the part of the damage that is felt in that Member State. This corresponds to the Member States where an exploitation of the work can be found (where the public is targeted). Given the rulings of the Court in *Wintersteiger* and *Pammer/Hotel Alpenhof*, it is not sufficient that a work is accessible to find jurisdiction in that Member State.

While the courts generally try to apply the *lex fori*, the applicable law should by principle be determined by reference to the principle *lex loci protectionis*. The Member State for which protection is claimed could be taken to refer to the country of transmission or reception, depending on the connecting factors. Logically it could be expected that the law of the Member State where the act of making available takes place applies, but this is not always the case (e.g. partial damages).

The localisation of the making available right does not solve the bottlenecks found in the current state of law in case of infringement. The author or right holder has several options depending on the measures pursued. She can still be expected to act in several Member State (provisional measures, cessation measures on the merits or partial damages). The applicable law will most likely be determined by the “country of origin”, which means that the behaviour of the defendant is decisive and that the right holder may be at a disadvantage. The alleged infringer may be brought before the courts of her domicile/establishment or where she has performed the act of upload and will be judged by the law of the Member State of origin, which also depends on where she performs the act of making available. However, she can also be called to defend her position before the courts of other Member States for provisional measures, cessation measures on the merits or partial reparation of the damage, which will be assessed by the laws of the country of origin. The alleged infringer, by her factual behaviour, has a possibility to weigh on the way of the infringement will be assessed. In theory, this may lead her to localise the act of making available in a Member State with a lower overall level of protection in case of infringement (despite the harmonisation of the enforcement of IP rights in Directive 2008/48).

The localisation in one country of origin of the upload might have an impact on who is identified as the **author or initial owner of copyrights**. The divergence of national rules on authorship or initial ownership will have less effect on one cross-border transaction. If the *lex loci protectionis* principle is applied or if the “country of origin” principle is read as a principle containing a conflict of laws rule, then one person is regarded as the author or initial owner per act of making available (despite its cross-border effects). The national divergences are felt where different acts of making available take place in Member States with different authorship rules. Complications could be overcome by harmonising the rule on authorship and initial ownership at the European level. Such harmonisation would however not prevent the contractual fragmentation of rights per national territory. In these scenarios, one person is regarded as the holder of the making available right per act of making available: she has the prerogative of granting a licence for the acts of making localised in that Member State and to take legal action against infringements of this right.

This construction addresses the bottlenecks found with regard to cross-border licences. It is less complicated to clear the making available rights for cross-border on demand exploitations, since only the consent of the person holding the making available right in the Member State of origin is required and not for the Member States where the work is exploited or where it is accessible. It also creates new bottlenecks. Firstly, the localisation (and therefore the entitlement of the different right holders) depends on the acts of the uploader, who may choose a location in her own favour (generally with a lower overall copyright protection) or by criteria that are not relevant from a copyright perspective (e.g. an establishment for fiscal reasons). Secondly, licences granted by the person who owns rights in one Member State may affect, even undermine the rights of persons in other Member States (in case of territorial fragmentation). The exploitation of the work by making it available on demand may be directed at one Member State; while the underlying act of making available to the public is localised in another Member State (upload, centre of activities of the uploader) and requires the consent of the right holder in that Member State, which means that the right holder in the Member State of exploitation is considered irrelevant in this process. There is no necessary link between making available of the work and its effects or the exploitation of the work.

Right holders may use contractual constructions to restrict the exploitation of the work to national territories, thus requiring uploaders/service providers to make a work available in one Member State and to restrict access to the work to users being present on the territory of that Member State (i.e. excluding access from outside the Member State). The effect of localising the act of making available in one Member State is thus undermined by contractual practice. Such practices may constitute an infringement on the freedom to provide services within the EU or competition law. Such restrictions may however be justified by demonstrating that these are necessary to protect the essential subject matter of copyright protection.

The **reproduction right** may be exercised, by reference to the act of making available, upstream (server) or downstream (end-user's end). These reproductions may take place in the Member State where the act of making available takes place or in another Member State. The rights of making available and reproduction may be held by the same person or different people. Depending on where the reproduction takes place and who holds the relevant rights, the licensing process is more or less complicated. Where the localisation of the making available right in one Member State is expected to simplify the licensing process (leaving other corollaries aside), this effect is evened out by the obligation to clear the reproduction rights both upstream and downstream outside the Member State of making available. By contrast, this obligation does not redress the situation of the holders of making available right in the Member States of exploitation, to the extent that the reproduction right may be held by yet other persons.

The holders of the rights of making available and reproduction can bring separate actions in case of infringement. Where the end-user's reproductions are not exempted under the exception for temporary acts of reproduction and have not been authorised (possibly via the service provider who has cleared the making available right in the country of origin); the end-user may thus be at risk of being held liable for an infringement of the reproduction right.

- **Exploitation/targeted public**

The second approach examined was to define the making available right as an act of **exploitation** (in function of the technology and the exploitation on that basis) and localised in the Member State(s) where the exploitation of the work is found. While the current situation leaves room for doubt, it is clear under this approach that the mere circumstance that a work is accessible is not sufficient to find an act of making available. The localisation criterion in practice can be understood as the targeting or the intention to target a public of a Member State. Elements that indicate such targeting will have to be found in the circumstances of each case and examples can be found in the decisions of the CJEU (*Pammer/Alpenhof*, *eBay*, *Donner*, *Sportradar*). When a work is exploited in several Member States (i.e. it is accessible on demand of the user and the user is part of the public the uploader intends to address), several acts of making available can be found in those Member States (where the public is targeted).

**Conflict of laws.** The impact of the exploitation scenario on the issues of private international law is limited by comparison to the current situation. It does not affect the application of the rules on

jurisdictions: a case can be brought before the courts of the Member State where the defendant is domiciled, where the event giving rise to the infringement took place or where the damage occurs, depending on the claimed measures.

As to the applicable law, the *lex loci protectionis* could refer to the application of the law of the country of transmission or to the application of the laws of the countries of reception. Logically it could be expected that the laws of the Member States where the act of making available takes place apply, which should lead to the cumulative application of the law(s) of the Member State(s) where the work is exploited. This could clarify the issues on applicable law and eventually limit the number of copyright legislation to take into account (excluding the laws of the Member States where the work is merely accessible).

**Author/initial right owner.** The national divergences on the rules of authorship and initial ownership continue to be felt in the exploitation approach (unless the *lex loci originis* of the work is applied to identify the original right holder). Similarly, the making available rights may be contractually fragmented per territory. The right holder can grant a licence or take legal action against an infringement for the Member State where the exploitation takes place. Her rights in any given territory will not be undermined by right holders in other Member States: if the public in the Member State for which she holds the making available right is targeted, then her prior authorisation is required. It matters not where the uploader performed the material act of upload or where its centre of activities is situated, the value of the making available right is not affected by manoeuvres of the uploader. By contrast, no infringement occurs when the work is accessible (outside the targeted territories) without the consent of the person holding the right for that territory.

The exploitation approach does not solve the bottlenecks found in the current state of the law with regard to the licensing process for cross-border transactions. The uploader should obtain the right holders' consent prior to making the work available to the public for all the Member States where the exploitation is intended. This means that the uploader should identify author, initial or derived right holder(s) in the Member States where the making available takes place. This approach clarifies the current situation to the extent that the mere accessibility outside the member States of exploitation ("spill over") does not necessitate the author's consent, nor technical measures to exclude access by persons outside the territory of exploitation.

In addition to the making available right, acts of **reproduction** can be found upstream and downstream from this availability. Depending on who holds these rights and where the restricted acts take place, the uploader and/or end-user are required to clear the reproduction rights for all acts that are not exempted. The uploader should clear the making available right in the targeted Member State and the reproduction right for the foreseeable reproductions (upstream and downstream). It can be expected that reproductions will be made at the end-user's end in the Member State where the public is targeted. If the rights of reproduction and making available are held by different persons, then the consent of both should be obtained. The uploader may be at risk when the work is reproduced in a Member State where the public is not targeted in terms of the on demand availability. This is less foreseeable for the uploader, yet she may incur responsibility for the end-user's reproduction if the national law holds intermediaries responsible for such reproductions. This burden may fall upon the end-user as well. The exploitation approach does not solve the bottlenecks found under the current state of law with regard to the reproduction right.

## Summarising table

	<b>Country of origin (act of upload, country of establishment or combination of both)</b>	<b>Exploitation scenario</b>
<b>Authorship / Initial ownership</b>	<p><i>a) Application of the lex loci protectionis</i></p> <p>Authorship and initial ownership are ruled according to the law applicable in the country of origin. The identity of the rights holder may vary in function of the localization of the protected act.</p> <p>→ The consequence of the existing disparities related to authorship/initial ownership is a potential risk of forum shopping to find the most favorable regime.</p> <p><i>b) Application of the lex loci originis</i></p> <p>Authorship and initial ownership are determined according to the law applicable in the country of first publication of the work/the country of nationality of the author. The rights holder is invariable, wherever the protected act is located.</p> <p>→ The country of origin principle does not change the situation resulting from the existing disparities on authorship/initial ownership.</p>	<p><i>a) Application of the lex loci protectionis</i></p> <p>Authorship and initial ownership are ruled according to the law applicable in the country(ies) of exploitation. The identity of the rights holder may vary in function of the countries targeted by the protected act.</p> <p>→ The exploitation scenario does not cause a new effect on the existing disparities on authorship/initial ownership.</p> <p><i>b) Application of the lex loci originis</i></p> <p>Authorship and initial ownership are determined according to the law applicable in the country of first publication of the work/the country of nationality of the author. The rights holder is invariable, wherever the protected act is located.</p> <p>→ The exploitation scenario does not change the situation resulting from the existing disparities on authorship/initial ownership.</p>
<b>Contractual transfer of rights</b>	<p><i>a) Transfer of rights with the purpose of an act of making available</i></p> <p>The law applicable to the contract is the law of the country of origin.</p> <p>→ The consequence of the existing disparities related to transfer of rights is a potential risk of forum shopping to locate the act of making available at the place with the most favorable regime.</p>	<p><i>a) Transfer of rights with the purpose of an act of making available</i></p> <p>The law applicable to the contract is the law of the country (ies) where the work is exploited.</p> <p>→ The exploitation scenario does not have a new effect on the existing disparities related to the transfers of rights.</p>

	<p><i>b) Transfer of rights prior to the making available right</i></p> <p>The law applicable to the contract is the <i>lex contractus</i>, as it was determined either by the contracting parties or by the other rules of the Regulation Rome I.</p> <p>→ The application of the country of origin principle does not have a new impact on the disparities related to the transfers of rights.</p>	<p><i>b) Transfer of rights prior to the making available right</i></p> <p>The law applicable to the contract is the <i>lex contractus</i>, as it was determined either by the contracting parties or by the other rules of the Regulation Rome I.</p> <p>→ The exploitation scenario does not have a new impact on the disparities on transfer of rights.</p>
<b>Conflicts of laws</b>	<p><i>a) Jurisdiction</i></p> <p>The courts of the country of origin (all damage) and the courts of the country where the work is accessed (for the damage in that country) will be competent.</p> <p>→ The country of origin principle does not have an impact on the issues of jurisdiction.</p> <p><i>b) Applicable law</i></p> <p>According to the <i>lex loci protectionis</i>, the law applicable is either the law of the country of transmission (which would be the country of origin) or the law of the country of reception.</p> <p>→ If the law of the country of transmission prevails (which would be conform to the country of origin principle) there is a risk of forum shopping. The country of origin principle might thus have an impact on the issues of applicable law.</p>	<p><i>a) Jurisdiction</i></p> <p>The courts of the country of upload (all damage) and the courts of the country where the work is accessed (for the damage in that country) will be competent.</p> <p>→ The exploitation scenario does not have an impact on the issues of jurisdiction.</p> <p><i>b) Applicable law</i></p> <p>According to the <i>lex loci protectionis</i>, the law applicable is either the law of the country of transmission or the law of the country of reception (which would be the countries of exploitation).</p> <p>→ If the law of the country of reception prevails (which would be conform to the targeting approach), then the protected act is located in the country(ies) targeted by the exploitation of the work, thus potentially in several Member States. The exploitation scenario should not have an impact on the issues of applicable law.</p>
<b>Reproduction right</b>	<p>In addition to a single act of making available to the public, several reproductions (upstream and downstream) should be taken into consideration. If these acts happen in other Member States than the country of origin, then it is likely that</p>	<p>In addition to the acts of making available in the Member States of exploitation, several reproductions (upstream and downstream) should be taken into consideration. If the work is accessible in other Member States than where the public is</p>



	<p>the reproduction(s) will be subject to the law of those Member States</p> <p>→The country of origin principle does not solve the problem of the relation between the making available right and the reproduction right.</p>	<p>explicitly targeted, then it is likely that a reproduction will be to the law of those Member States.</p> <p>→ The exploitation scenario does not solve the problem of the relation between the making available right and the reproduction right.</p>
--	--	---

## Bibliography

### Legislation

#### *Treaties*

WIPO Copyright Treaty (WCT) and WIPO Performances and Phonograms Treaty (WPPT), both adopted in Geneva on December 20, 1996.

Convention on jurisdiction and the recognition and enforcement of judgments in civil and commercial matters (*“Lugano Convention”*).

#### *Regulations*

Council Regulation (EC) No 44/2001 of 22 December 2000 on jurisdiction and the recognition and enforcement of judgments in civil and commercial matters, *OJ L 12, 16.1.2001, p. 1–23*.

Regulation (EC) No 864/2007 of the European Parliament and of the Council of 11 July 2007 on the law applicable to non-contractual obligations (Rome II) *OJ L 199, 31.7.2007, p. 40–49*.

Regulation (EC) No 593/2008 of the European Parliament and of the Council of 17 June 2008 on the law applicable to contractual obligations (Rome I), *OJ L 177, 04/07/2008, 6–16*

Regulation (EU) No 1215/2012 of the European Parliament and of the Council of 12 December 2012 on jurisdiction and the recognition and enforcement of judgments in civil and commercial matters, *OJ L 351, 20.12.2012, p. 1–32*.

#### *Directives*

Council Directive 89/552/EEC of 3 October 1989 on the coordination of certain provisions laid down by Law, Regulation or Administrative Action in Member States concerning the pursuit of television broadcasting activities, *OJ L 298, 17 October 1989, p. 23–30*.

Council Directive 93/83/EEC of 27 September 1993 on the coordination of certain rules concerning copyright and rights related to copyright applicable to satellite broadcasting and cable retransmission *OJ L 248, 6.10.1993, p. 15–21*

Directive 96/9/EC of the European Parliament and of the Council of 11 March 1996 on the legal protection of databases *Official Journal L 077, 27/03/1996 P. 0020 – 0028*.

Directive 98/48/EC of the European Parliament and of the Council of 20 July 1998 amending Directive 98/34/EC laying down a procedure for the provision of information in the field of technical standards and regulations *O.J. L 217, 05/08/1998, p. 18-26*.

Directive 98/34/EC of the European Parliament and of the Council of 22 June 1998 laying down a procedure for the provision of information in the field of technical standards and regulations, *O.J. L 204, 21/07/1998, p. 37-48*.

Directive 2001/29/EC of the European Parliament and of the Council of 22 May 2001 on the harmonisation of certain aspects of copyright and related rights in the information society, *OJ L 167, 22.6.2001, p. 10–19, hereafter referred to as “Information Society Directive” or “InfoSoc Dir*

Directive 2004/48/EC of the European Parliament and of the Council of 29 April 2004 on the enforcement of intellectual property rights, *OJ L 157, 30 April 2004, p. 45–86*.

Directive 2006/115/EC of the European Parliament and of the Council of 12 December 2006 on rental right and lending right and on certain rights related to copyright in the field of intellectual property (codified version) *O.J. L 376* , 27/12/2006 P. 0028 – 0035.

Directive 2006/116/EC of the European Parliament and of the Council of 12 December 2006 on the term of protection of copyright and certain related rights (codified version), *OJ L 372*, 27 December 2006, p. 12–18.

Directive 2006/123/EC of the European Parliament and of the Council of 12 December 2006 on services in the internal market, *OJ L 376*, 27 December 2006, p. 36–68:

Directive 2009/24/EC of the European Parliament and of the Council of 23 April 2009 on the legal protection of computer programs (Codified version) (Text with EEA relevance), *OJ L 111*, 5.5.2009, p. 16–223

Proposal for a Directive of the European Parliament and of the Council on collective management of copyright and related rights and multi-territorial licensing of rights in musical works for online uses in the internal market, COM(2012) 372 final, 2012/0180 (COD), 11 July 2012, accessible via [http://ec.europa.eu/internal\\_market/copyright/docs/management/com-2012-3722\\_en.pdf](http://ec.europa.eu/internal_market/copyright/docs/management/com-2012-3722_en.pdf).

## Decisions

### CJEU

CJEU, 30 November 1976, Case C-21/76, *Handelskwekerij G. J. Bier BV v Mines de potasse d'Alsace*, *ECR*, 1976, 01735.

CJEU 25 July 1991, Case C-221/89, *The Queen v Secretary of State for Transport, ex parte Factortame Ltd and others*.

CJEU 4 October 1991, Case C-246/89, *Commission of the European Communities v United Kingdom of Great Britain and Northern Ireland*.

CJEU 26 March 1992, Case C-261/90, *Mario Reichert, Hans-Heinz Reichert and Ingeborg Kockler v Dresdner Bank AG*.

CJEU 7 March 1995, Case C-68/93, *Fiona Shevill, Ixora Trading Inc., Chequepoint SARL and Chequepoint International Ltd v Presse Alliance SA*, *ECR*, 1995, I, 00405 (Shevill).

CJEU 5 June 1997, Case C-56/96, *VT4 Ltd v Vlaamse Gemeenschap*.

CJEU 17 November 1998, Case C-391/95, *Van Uden Maritime BV, trading as Van Uden Africa Line v Kommanditgesellschaft in Firma Deco-Line and Another (Van Uden)*.

CJEU 6 February 2003, Case C-245/00, *Stichting ter Exploitatie van Naburige Rechten (SENA) v Nederlandse Omroep Stichting (NOS)*.

CJEU 28 April 2005, Case C-104/03, *St. Paul Dairy Industries NV v Unibel Exser BVBA (St. Paul)*.

CJEU 2 June 2005, Case C-89/04, *Mediakabel BV v Commissariaat voor de Media*, Reports of Cases 2005 I-04891 (Mediakabel).

CJEU 14 July 2005, Case C-192/04, *Lagardère Active Broadcast v Société pour la perception de la rémunération équitable (SPRE) and Gesellschaft zur Verwertung von Leistungsschutzrechten mbH (GVL)*, Reports of Cases 2005 I-07199, opinion of Advocate-General TIZZANO of 21 April 2005 (Lagardère).

CJEU 12 September 2006, Case C-196/04, Cadbury Schweppes plc and Cadbury Schweppes Overseas Ltd v Commissioners of Inland Revenue.

CJEU 7 December 2006, Case C-306/05, SGAE v Rafael Hoteles ;

Order of the President of the Fourth Chamber of the Court of 27 September 2007, case nr. Case C-175/06, Alessandro Tedesco v Tomasoni Fittings Srl and RWO Marine Equipment Ltd, opinion of Advocate-General KOKOTT of 18 July 2007.

CJEU 17 April 2008, Case C-456/06, Peek & Cloppenburg v Cassina, par.36.

CJEU, 23 April 2009, Case C-533/07, Falco Privatstiftung and Thomas Rabitsch v Gisela Weller-Lindhorst, *ECR*, 2009, I, 03327

CJEU 16 July 2009, Case C-5/08, Infopaq International A/S v Danske Dagblades Forening (Infopaq I)

CJEU 7 December 2010, joined Cases C-585/08 and C-144/09, Peter Pammer v Reederei Karl Schlüter GmbH & Co KG (C-585/08) and Hotel Alpenhof GesmbH v Oliver Heller (C-144/09) (Pammer/Alpenhof).

CJEU 16 June 2011, Case nr. C-462/09, Stichting de ThuisKopie t. Opus Supplies Deutschland, Mijndert van der Lee and Hananja van der Lee.

CJEU 12 July 2011, Case C-324/09, L'Oréal SA and Others v eBay International AG and Others, opinion Advocate General Jääskinen of 9 December 2010 (eBay)

CJEU 4 October 2011, joined Cases C-403/08 and C-429/08, Football Association Premier League Ltd and Others v QC Leisure and Others (C-403/08) and Karen Murphy v Media Protection Services Ltd (C-429/08) (hereafter "FAPL" or "Premier League")

CJEU 13 October 2011, joined Cases C-431/09 and C-432/09, Airfield NV and Canal Digitaal BV v Belgische Vereniging van Auteurs, Componisten en Uitgevers CVBA (Sabam) (C-431/09) and Airfield NV v Agicoa Belgium BVBA (C-432/09) (Airfield)

CJEU 25 October 2011, joined Cases C-509/09 and C-161/10, eDate Advertising GmbH v X (C-509/09) and Olivier Martinez and Robert Martinez v MGN Limited (C-161/10) (eDate Advertising)

CJEU 24 November 2011, Case C-283/10, Circul Globus București (Circ & Variete Globus București) v Uniunea Compozitorilor și Muzicologilor din România – Asociația pentru Drepturi de Autor (UCMR – ADA)

CJEU 1 December 2011, Case C-145/10, Eva-Maria Painer v Standard VerlagsGmbH and Others (Painer).

CJEU 17 January 2012, Case C-302/10, Infopaq International A/S v Danske Dagblades Forening (Infopaq II)

CJEU 9 February 2012, Case C-277/10, Martin Luksan v Petrus van der Let.

CJEU 15 March 2012, Case C-135/10 Consorzio Fonografici v Del Corso (Del Corso).

CJEU 15 March 2012, Case C-162/10, Phonographic Performance v Ireland (PPI).

CJEU 26 April 2012, Case C-523/10, Wintersteiger AG v Products 4U Sondermaschinenbau GmbH (Wintersteiger).

CJEU 21 June 2012, Case C-5/11, criminal proceedings against Titus Donner, opinion Advocate General JÄÄSKINEN of 29 March 2012 (Donner).

CJEU 3 July 2012, Case C-128/11, UsedSoft GmbH v Oracle International Corp (UsedSoft).

CJEU 12 July 2012, Case C-616/10, Solvay SA v Honeywell Fluorine Products Europe BV, Honeywell Belgium NV, Honeywell Europe NV.

CJEU 18 October 2012, case C-173/11, Football Dataco Ltd, Scottish Premier League Ltd, Scottish Football League, PA Sport UK Ltd v Sportradar GmbH, Sportradar AG (Sportradar).

CJEU 7 March 2013, case C-607/11, ITV Broadcasting e.a. v TVCatchup (TVCatchup).

Opinion of the Advocate general JÄÄSKINEN of 13 June 2013 in the case C-170/12, Peter Pinckney v KDG Mediatech AG.

Reference for a preliminary ruling from the Svea hovrätt (Sweden) lodged on 18 October 2012 - Nils Svensson, Sten Sjögren, Madelaine Sahlman, Pia Gadd v Retreiver Sverige AB, case C-466/12 (Svensson)

Request for a preliminary ruling from the Högsta domstolen (Sweden) lodged on 22 May 2013, Case C-279/13, C More Entertainment AB v Linus Sandberg.

Reference for a preliminary ruling from the Krajský soud v Plzni (Czech Republic) lodged on 24 July 2012 - Ochranný svaz autorský pro práva k dílům hudebním, o.s. (OSA) v Léčebné lázně Mariánské Lázně, a.s., case nr. C-351/12

### **Other**

Commission decision of 16 July 2008, C(2008) 3435 final and General Court 12 April 2013, case T-422/08, CISAC v European Commission.

### **National Courts**

#### **▪ Belgium**

Cass. 14 January 1997, Bull., 1997, I, n° 14, 8; Cass. 27 March 2007, Bull., 2007, I, n° 132.

Cass. 5 March 2002, Bull., 2002, I, n° 75, 58; Cass. 30 January 2007, Bull., 2007, I, n° 44, 37.

Cass. 27 May 2005, dock nr. C.03.0610.N, SABAM, I.F.P.I. v Goossens, A&M 2005, 414.

Cass., 29 March 2011, retrieved via [www.legalis.net](http://www.legalis.net)

Brussels, 4 May 2001, J.L.M.B., 2001, 1444-1450

Brussels, 5 May 2011, retrievable via [www.juridat.be](http://www.juridat.be)

Antwerpen 26 September 2011 AM 2012, afl. 2-3, 216; ICIP 2011, afl. 5-6, 731; RABG 2011, afl. 18, 1269, note P. VAN EECKE, A. FIERENS.

Civ. Liège (Prés), 28 april 2008, J.L.M.B., 1015-1023.

#### **▪ France**

Cass. 17 mars 1982, *JCP G*, 1983, II, 20054.

Cass. 28 May 1991, retrievable via <http://www.legifrance.gouv.fr/>

Cass. 14 January 1997, *Bull.*, 1997, I, n° 14, 8

Cass. 5 March 2002, *Bull.*, 2002, I, n° 75, 58

Cass. 30 January 2007, *Bull.*, 2007, I, n° 44, 37.

Cass. 27 March 2007, *Bull.*, 2007, I, n° 132.

Cass 12 July 2012, n° M 11-15.188 and n° M 11-15.165, <http://www.legifrance.gouv.fr/>.

Cass. 10 April 2013, <http://www.legifrance.gouv.fr/>

Paris 9 September 2009, retrieved via [www.legalis.net](http://www.legalis.net)

Paris, 26 January 2011, retrieved via [www.juriscom.net](http://www.juriscom.net)

Paris 14 December 2011, *Wizzgo c Metropole Television et autres* (2011). Retrieved from [http://www.legalis.net/spip.php?page=jurisprudence-decision&id\\_article=3297](http://www.legalis.net/spip.php?page=jurisprudence-decision&id_article=3297).

TGI Paris, 18 December 2009, retrieved via [www.legalis.net](http://www.legalis.net)

#### ▪ **Germany**

BGH 22 April 2009, I ZE 175/07, "Save.tv". BGH, 22 April 2009, I ZR 216/06, "Shift.tv", via [www.juris.bundesgerichtshof.de](http://www.juris.bundesgerichtshof.de).

BGH 8 December 2010 GRUR 2011 227.

BGH 11 April 2013, I ZR 152/11, « Internet Videorecorder II », accessible via <http://www.bundesgerichtshof.de>.

OLG Köln, 30 October 2007, *GRUR*, 2008, 71

OLG Stuttgart 21 January 2008, Az. 2 WS 328/07; 2 Ws 328/2007, *Telemachus*, available via <http://tlmd.in/u/488>.

OLG Düsseldorf 27 April 2010, case I-20 U 166/.

OLG München 24 April 2010. OLG Dresden, 12 July 2011, case nr. 14 U 801/07, *GRUR RR* 2011, 413.

OLG Hamburg 14 March 2012, Az. 5 U 87/09 : press communication "Urheberrechtswidrige Downloads: Oberlandesgericht Hamburg entscheidet über Prüf- und Handlungspflichten des Online-Speicher-Dienstes "RapidShare", 15 March 2012, <http://justiz.hamburg.de/presseerklaerungen/3334434/pressemeldung-2012-03-15-olg.html>.

LG München, Urteil 30 July 2009, Az. 7 O 13895/08, retrieved via <http://www.damm-legal.de/lg-muenchen-i-gerichtsstand-bei-rechtsverletzungen-im-internet-dort-wo-potentielle-kunden-sind>

LG München 25 June 2009

LG Bielefeld 5 March 2013, case nr. 4 O 191/11, accessible via [http://www.boersenverein.de/sixcms/media.php/976/LG\\_Bielefeld\\_vom\\_05.03.13\\_Klage\\_Verbraucherzentralen.pdf](http://www.boersenverein.de/sixcms/media.php/976/LG_Bielefeld_vom_05.03.13_Klage_Verbraucherzentralen.pdf)

#### ▪ **Italy**

Italian Supreme Court 13 October 2009, judgment n. 21661.

### ▪ The Netherlands

Hoge Raad 18 February 2005, NJ, 2005, 404.

Gerechtshof Amsterdam 15 January 2013 (case nr. 200.095.838/01), accessible via <http://ie-forum.nl/index.php?//Eenvoudige+hyperlink+naar+antwoordboeken+en+uitwerkingen+onrechtmatig///31097/> and [www.rechtspraak.nl](http://www.rechtspraak.nl).

Gerechtshof Amsterdam 15 June 2006, Rolnummer 1157/04, "ZoekMP3", AMI 2006/5, 173

Gerechtshof 's Gravenhage 22 December 2010, "eDonkey", AMI 2011/5, 183-186, note M.J.A. Duker

Arrondissementsrechtbank Haarlem 22 March 2006, Mom v VNU, AMI 2006, 4, 136-139, note Koelman.

Rb. Utrecht 26 August 2009, LJN BJ6008; B9 8127, Brein v Mininova, AMI 2009, 215-217

Rechtbank Amsterdam (Voorz.), 22 October 2009, AMI, 2010, 18.

Rb Haarlem 17 August 2011, case nr 173726 / HA ZA 10-1325.

Rb. Amsterdam 12 September 2012, Sanoma Media, Playboy Enterprises International and X v GS Media (*GeenStijl*), accessible via [ww.iept.nl](http://www.iept.nl).

Voorzieningenrechter Rb Amsterdam 22 oktober 2009, Neij c.s. v Brein, AMI 2010/1, 18-24, note Hugenholtz.

Vz. Rb. Den Haag 22 March 2011, KNVB and UFA Sports c.s. v MyP2P Holding, AMI 2011/3, 108.

### ▪ United Kingdom

UK Supreme Court 17 April 2013, Public Relations Consultants Association Limited v The Newspaper Licensing Agency Limited and others, [2013] UKSC 18, accessible via [http://www.supremecourt.gov.uk/decided-cases/docs/UKSC\\_2011\\_0202\\_Judgment.pdf](http://www.supremecourt.gov.uk/decided-cases/docs/UKSC_2011_0202_Judgment.pdf) (Meltwater),

Court of appeal 27 July 2011, [2011] EWCA Civ 890.

Court of appeal 29 March 2011, Football Dataco e.a. v Sportradar e.a., EWCA 2011, civ 330, retrieved from <http://www.bailii.org/ew/cases/EWCA/Civ/2011/330.html>;

Court of appeal's decision of 27 July 2011, [2011] EWCA Civ 890 (Meltwater)

Court of appeal 6 February 2013, case Nos A3/2012/1349, 1352, 1364, 1366, Football Dataco Ltd and others and Stan James and others, Sportradar GmbH and another, [2013]EWCA Civ 27.

High Court of Justice 29 March 2010, Twentieth Century Fox Film Corporation & Anor v Newzbin Ltd., EWHC 2010, retrieved from <http://www.bailii.org/ew/cases/EWHC/Ch/2010/608.html>.

High Court of Justice 17 November 2010, Football Dataco e.a. v Sportradar e.a., EWHC 2010, 2911, retrieved from <http://www.bailii.org/ew/cases/EWHC/Ch/2010/2911.html>

High Court of Justice 26 November 2010, [2010] EWHC 3099 (Ch);

High Court 28 July 2011, [2011] EWHC 1981 (Ch), accessible via <http://www.bailii.org/ew/cases/EWHC/Ch/2011/1981.html>.

High Court of Justice 20 February 2012, *Dramatico Entertainment Limited e.a. v British Sky Broadcasting Limited e.a.* EWHC. (2012), retrieved from <http://www.bailii.org/ew/cases/EWHC/Ch/2012/268.html>

High Court of Justice 28 February 2013 [2013] EWHC 379 (Ch), *EMI and others v British Sky Broadcasting and others*, nrs. 24 and 38 et s.

#### ▪ **Australia, Canada, USA**

Federal Court of Australia 1 February 2012, *Singtel Optus Pty Ltd v National Rugby League Investments Pty Ltd (No 2)* [2012] FCA 34, accessible via <http://www.austlii.edu.au/au/cases/cth/FCA/2012/34.html>.

Federal Court of Australia 27 April 2012, *National Rugby League Investments Pty Limited v Singtel Optus Pty Ltd* [2012] FCAFC 59, accessible via <http://www.austlii.edu.au/cgi-bin/sinodisp/au/cases/cth/FCAFC/2012/59.html>.

Canadian Supreme Court, *Society of Composers, Authors and Music Publishers of Canada v. Canadian Assn. of Internet Providers*, 2004 SCC 45 ; [2004] 2 S.C.R. 427 (June 30, 2004), retrievable via <http://scc.lexum.org>.

US Court of Appeals for the second circuit 4 August 2008, *Cartoon Network, LP v. CSC Holdings, Inc.*, 536 F.3d 121 (2d Cir. 2008), accessible via [http://www.ca2.uscourts.gov/decisions/isysquery/339edb6b-4e83-47b5-8caa-4864e5504e8f/1/doc/07-1480-cv\\_opn.pdf](http://www.ca2.uscourts.gov/decisions/isysquery/339edb6b-4e83-47b5-8caa-4864e5504e8f/1/doc/07-1480-cv_opn.pdf).

US Court of Appeals (2nd. Circ. NY), 12 May 2011, retrieved via <http://law.justia.com>

US Court of appeals for the second circuit, 1 April 2013, *WNET, Thirteen v. Aereo, Inc.* 12-2786-cv, 12-2807-cv.

US District Court Southern District of New York 30 March 30 March 2013, case No 12 Civ. 95 (RJS), accessible via <http://ia600800.us.archive.org/30/items/gov.uscourts.nysd.390216/gov.uscourts.nysd.390216.109.0.pdf>

### **Scholarly literature**

L. BENTLY & B. SHERMAN, *Intellectual Property Law*, Oxford University Press, 2009, 1144

J.-S. BERGE, *La loi applicable à la circulation des oeuvres de l'esprit sur les réseaux numériques : le point de vue d'un juriste français*, Rapport remis au Ministère de la Culture et de la Communication dans le cadre des activités du CERDI, sept. 1999, 86 p.

N. BOSCHIERO, "Intellectual Property in the light of the European conflict of laws", 16 p. <http://www.ialsnet.org/meetings/business/BoschieroNerina-Italy.pdf>

R. CASAS e.a., *ALAI-Study Days 2012 – KYOTO. Questionnaire Spain*, 2012, 18 p., [http://www.alai.jp/ALAI2012/program/national\\_report/Spain.pdf](http://www.alai.jp/ALAI2012/program/national_report/Spain.pdf)

A. CRUQUENAIRE, "La loi applicable au droit d'auteur : état de la question et perspectives", AM 2000, 210-227, accessible via <http://www.crid.be/pdf/public/4048.pdf> .



S.A. DAVIDSON, "California federal district court judge grants injunction against "Aereo" copycat service, questions reasoning of Second Circuit's decision in the cablevision remote-storage/DVR case", *Lexology*, 2 January 2013, accessible via <http://www.lexology.com/library/detail.aspx?g=e7fc8855-c4cb-4a7a-95d3-b66d305f02fe>.

A. DE FRANQUEN, "L'arrêt Google contre Copiepresse et le choix de la loi applicable en matière d'atteinte au droit d'auteur sur Internet", *R.D.T.I.* 2011, 35-74

E. DERCLAYE, *Research handbook on the future of EU copyright*, Edward Elgar Publishing, 2009, 672 p.

F. DE VISSCHER and B. MICHAUX, *Précis du droit d'auteur et des droits voisins*, Bruylant, 2000, 638 ;

R. DI NOTO, "La compétence internationale des juridictions françaises et allemandes en matière de cyber-délits de concurrence déloyale et de contrefaçon", *Coopération judiciaire internationale et européenne (Master d'Etudes bilingues des droits de l'Europe)* 15 March 2009, retrieved via <http://m2bde.u-paris10.fr/content/la-comp%C3%A9tence-internationale-des-juridictions-fran%C3%A7aises-et-allemandes-en-mati%C3%A8re-de-cyber-d>.

EUROPEAN COPYRIGHT SOCIETY, Opinion on the reference to the CJEU in case C-466/12 Svensson, 15 February 2013, accessible via [http://www.ivir.nl/news/European\\_Copyright\\_Society\\_Opinion\\_on\\_Svensson.pdf](http://www.ivir.nl/news/European_Copyright_Society_Opinion_on_Svensson.pdf).

European Max Planck Group on Conflict of Laws in Intellectual Property, *Principles on Conflict of Laws in Intellectual Property*, 1 December 2011, retrieved from [http://www.cl-ip.eu/files/pdf2/Final\\_Text\\_1\\_December\\_2011.pdf](http://www.cl-ip.eu/files/pdf2/Final_Text_1_December_2011.pdf).

A. GIEDKE, *ALAI Congress 2012 – Kyoto Questionnaire – Germany*, 2012, 51 p. via [http://www.alai.jp/ALAI2012/program/national\\_report/Germany.pdf](http://www.alai.jp/ALAI2012/program/national_report/Germany.pdf).

J. C. GINSBURG, "Berne Without Borders: Geographic Indiscretion and Digital Communications", Stephen Stewart Memorial Lecture, Intellectual Property Institute London U.K., 29 October 2001, retrieved from [http://papers.ssrn.com/sol3/papers.cfm?abstract\\_id=292010](http://papers.ssrn.com/sol3/papers.cfm?abstract_id=292010)

J.C. GINSBURG, "Conflict of Laws in the Google Book Search: A View From Abroad", *The Media Institute*, 2 June 2010, [http://www.mediainstitute.org/IPI/2010/060210\\_ConflictOfLaws.php](http://www.mediainstitute.org/IPI/2010/060210_ConflictOfLaws.php)

J.C. GINSBURG, "Where does the act of "making available" occur?", *The Media Institute*, 29 October 2012, <http://www.mediainstitute.org/IPI/2012/102912.php>.

J.C. GINSBURG, "Where Does the Act of "Making Available" Occur?" Part II, *The Media Institute*, 18 June 2013, <http://www.mediainstitute.org/IPI/2013/061813.php>.

J.C. GINSBURG, "*WNET v. Aereo: The Second Circuit Persists in Poor (Cable)Vision*", *The Media Institute*, 23 April 2013, <http://www.mediainstitute.org/IPI/2013/042313.php>.

P. GOLDSTEIN & P.B. HUGENHOLTZ, *International Copyright*, Oxford, University Press, 2010, 592 p.

L. GUIBAULT and B. HUGENHOLTZ, *Study on the conditions applicable to contracts relating to intellectual property in the European Union*, IViR, 2002, 179 p., retrieved via [http://ec.europa.eu/internal\\_market/copyright/docs/studies/etd2000b53001e69\\_en.pdf](http://ec.europa.eu/internal_market/copyright/docs/studies/etd2000b53001e69_en.pdf).

L. GUIBAULT, G. WESTKAMP, Th. RIEBER-MOHN, P.B. HUGENHOLTZ, M. VAN EECHOUD, N. HELBERGER, L. STEIJGER, M. ROSSINI, N. DUFFT, Ph. BOHN, *Study on the Implementation and*

*Effect in Member States' Laws of Directive 2001/29/EC on the Harmonisation of Certain Aspects of Copyright and Related Rights in the Information Society*, IViR, 2007, 213 p., retrieved from [http://www.ivir.nl/publications/guibault/Infosoc\\_report\\_2007.pdf](http://www.ivir.nl/publications/guibault/Infosoc_report_2007.pdf).

H. HAOUIDEG, "Diffusion en continu sur Internet. Le webcasting constitue-t-il une radiodiffusion au sens de l'article 41 de la LDA ?", *AM* 2006/1, 10-20.

M. HO-DAC, *La loi du pays d'origine en droit de l'Union européenne*, Bruylant, 2012, 249.

P.B. HUGENHOLTZ, "The last frontier: Territoriality", in M. VAN EECHOUD, P. B. HUGENHOLTZ, S. VAN GOMPEL, L. GUIBAULT, & N. HELBERGER (Eds.), *Harmonizing European Copyright Law*, 2009, Alphen aan den Rijn: Kluwer Law International, p. 374.

P.B. HUGENHOLTZ, M. VAN EECHOUD, S. VAN GOMPEL, L. GUIBAULT, N. HELBERGER, M. ROSSINI, L. STEIJGER, N. DUFFT, Ph. BOHN, *The Recasting of Copyright & Related Rights for the Knowledge Economy*, IViR, 2006, 254 p., retrieved from [http://ec.europa.eu/internal\\_market/copyright/docs/studies/etd2005imd195recast\\_report\\_2006.pdf](http://ec.europa.eu/internal_market/copyright/docs/studies/etd2005imd195recast_report_2006.pdf).

H. KRISTJAN LARUSSON, "Uncertainty in the Scope of Copyright: The Case of Illegal File-Sharing in the UK", *E.I.P.R.* 2009, 31(3), 126.

F. LEJEUNE, "Contrefaçon, internet et compétence internationale : le droit d'auteur échapperait-il à la théorie de la focalisation ?", *A&M* 2011/4, 425-442.

B. LINDNER & T. SHAPIRO, *Copyright in the Information Society. A Guide to National Implementation of the European Directive*, Edward Elgar, Cheltenham, 2011, 648 p.

E. LINKLATER, "Waiting for a lower court to rein in resale? You'd sooner herd cats", *The IPKat*, 1 May 2013, accessible via <http://ipkitten.blogspot.be/2013/05/waiting-for-lower-court-to-reign-in.html>.

A. LUCAS "Applicable law in copyright infringement cases in the digital environment", *e-Copyright Bulletin*, 2005, 14 p. retrieved via [http://portal.unesco.org/culture/en/files/29336/11338009191lucas\\_en.pdf/lucas\\_en.pdf](http://portal.unesco.org/culture/en/files/29336/11338009191lucas_en.pdf/lucas_en.pdf). 8

A. LUCAS, "Private International Law aspects of the protection of works and of the subject matter of related rights transmitted over digital networks", *WIPO Forum on private international law and intellectual property*, Geneva 30-32 January 2001, 23 p retrieved from [http://www.wipo.int/edocs/mdocs/mdocs/en/wipo\\_pil\\_01/wipo\\_pil\\_01\\_1\\_prov.pdf](http://www.wipo.int/edocs/mdocs/mdocs/en/wipo_pil_01/wipo_pil_01_1_prov.pdf).

A. LUCAS, H.-J. LUCAS and A. LUCAS-SCHLOETTER, *Traité de la propriété littéraire et artistique*, LexisNexis, Paris, 2012, 1569 p.

J. MARTIN, *Réponse du groupe français au questionnaire relatif au congrès de l'association littéraire artistique internationale*, Kyoto, October 2012, 16 p., [http://www.alai.jp/ALAI2012/program/national\\_report/France.pdf](http://www.alai.jp/ALAI2012/program/national_report/France.pdf)

R. MATULIONYTÉ, "The Law Applicable to Online Copyright Infringements in the ALI and CLIP Proposals: A Rebalance of Interests Needed?", *Jipitec* 2011/2, 26-36.

R. MATULIONYTÉ, *Law applicable to copyright : a comparison to the ALI and CLIP proposals*, Edward Edgard Publishing Limited, Cheltenham, 2011, 288 p.

A. MOIR & D. PEARCE, "High Court orders BT to block its customers from accessing an unlawful file sharing site: Twentieth Century Fox Film Corp v British Telecommunications Plc.", *E.I.P.R.* 2011, 33(11), 736-738.

J-P MOINY, "Droit international et droit européen – L'intention "géodéterminée": un facteur de rattachement confirmé ?", *R.D.T.I.*, 2012, 208-244.

A. NUYTS, "Les mesures provisoires dans le Règlement Bruxelles Ibis", *R.D.C.-T.B.H.*, 2013, 348-356.

A. OHLY, "Economic rights" in E. DERCLAYE (ed.), *Research Handbook on the Future of EU Copyright*, Cheltenham, Edward Elgar, 2009, 212-241.

C. O'REILLY, "Finding jurisdiction to regulate Google and the Internet", *E.J.L.T.*, 2011/2, 2. 13 p. via <http://ejlt.org/article/view/57>.

A. PEUKERT, « Territoriality and Extraterritoriality in Intellectual Property Law » in G. HANDL & J. ZEKOLL (eds), *Beyond territoriality: transnational legal authority in an age of globalization*, Queen Mary Studies in International Law, Brill Academic Publishing, Leiden/Boston, 2011. Available at SSRN: <http://ssrn.com/abstract=1592263>.

J. REINBOTHE & S. VON LEWINSKI, *The WIPO Treaties 1996*, London, Butterworths, 2002, 581 p.

S. RICKETSON & J.C. GINSBURG, *International copyright and neighbouring rights*, Oxford, University Press, 2006, 1652 p.

RICOLFI, M., 'Comunicazione al pubblico e distribuzione', *Annali Italiani Diritto Autore (AIDA)*, 2002.

P. SAMUELSON, P. HILL, T. WHEATLAND "Statutory Damages: A Rarity in Copyright Laws Internationally, But For How Long?", 60 *J. Copyright Soc'y U.S.A.* (forthcoming September 2013), 14 p. accessible via [http://cyber.law.harvard.edu/people/tfisher/IP/Samuelson\\_SDs\\_2013.pdf](http://cyber.law.harvard.edu/people/tfisher/IP/Samuelson_SDs_2013.pdf).

M. SCHLESINGER, "Legal issues in peer-to-peer file sharing, focusing on the making available right" in A. STROWEL (ed), *Peer-to-peer file sharing and secondary liability in copyright law*, Cheltenham, Edward Elgar, 2009, 352 p. .

A. SCHNEIDER, "OLG Hamburg: Die Rapidshare-Entscheidung, ein Meilenstein?", *Telemedicus*, 29 March 2012, retrieved via <http://tlmd.in/a/2229>.

A. SCHNEIDER, "OLG Dresden klärt Rechtsstreit um Online-Videorekorder », *Telemedicus*, 15 July 2011, accessible via <http://www.telemedicus.info/article/2040-OLG-Dresden-klart-Rechtsstreit-um-Online-Videorekorder.html>

P. SIRINELLI, "Chronique de jurisprudence: Exploitation internationale des œuvres de l'esprit", *RIDA*, 2010/04.

A. SPIES, "Internet streaming of TV broadcasts: your 'one stop shop' update on international copyright disputes", *Lexology*, 20 May 2013, accessible via <http://www.lexology.com/library/detail.aspx?g=08ff7d51-1c40-4592-a275-1068fb0e5c02>.

J.H. SPOOR, D.W.F. VERKADE, D.J.G. VISSER, *Auteursrecht*, Kluwer, 2005, 762.

A. STROWEL & V. HANLEY, « Secondary liability for copyright infringement with regard to hyperlinks », in A. STROWEL (ed), *Peer-to-peer file sharing and secondary liability in copyright law*, Cheltenham, Edward Elgar, 2009, 352 p.

A. STROWEL and J.-P. TRIAILLE, *Le droit d'auteur, du logiciel au multimedia*, Kluwer, 1997, 520.

A. SUSSAROVA, "La portée du principe '*forum regit processum*' dans la pratique judiciaire belge", *R.D.C.*, 2012, 156-164.

E. TREPPOZ, "Droit européen de la propriété intellectuelle", *R.T.D.E.*, 2011, 847-870.

M. VAN EECHOUD, *Choice of law in copyright and related rights*, Kluwer, 2003, 304 p.

M. VAN EECHOUD, "Het Communautair Acquis voor auteursrecht en naburige rechten: Zeven zonden of zestien gelukkige jaren?", *AMI* 2007, 4, 109-117.

M. VAN EECKHOUD, P.B. HUGENHOLTZ, L. GUIBAULT, N. HELBERGER, S. VAN GOMPEL, *Harmonizing European Copyright Law: The Challenges of Better Lawmaking*, Kluwer, 2009, 400 p.

M. VAN EECHOUD, "Along the Road to Uniformity Diverse Readings of the Court of Justice Judgments on Copyright Work", 3 (2012) *JIPITEC*, 1, 60-80.

T. VERBIEST, M. DE BELLEFROID, A. SOKOLOWSKA, « Le régime de l'exception de la copie privée en droit français », *Droit & Technologies*, 10 September 2007, <http://www.droit-technologie.org/actuality-1070/le-regime-de-l-exception-de-la-copie-privee-en-droit-francais.html>.

S. VON LEWINSKI & M. M. WALTER, "Information Society Directive" in M.M. WALTER & S. VON LEWINSKI (ed), *European Copyright Law*, Oxford, University Press, 2010, 1632 p.

S. VON LEWINSKI, "Recent developments of German Authors' Rights Law", *AM* 2011/2, 162-178.

M. WALTER & L. RIEDE, "Principle of non-discrimination" in M. WALTER & S. VON LEWINSKI (ed), *European copyright law*, 2010, Oxford University Press, 1632 p.

X., Final report to the study on intellectual property and the conflict of laws, April 2000, 120 p. [http://ec.europa.eu/internal\\_market/copyright/docs/studies/etd1999b53000e16\\_en.pdf](http://ec.europa.eu/internal_market/copyright/docs/studies/etd1999b53000e16_en.pdf).

"Son of NewzBin: another victory for the film-makers", *The IPKat*, 28 July 2011, accessible via <http://ipkitten.blogspot.be/2011/07/son-of-newzbin-another-victory-for-film.html>.

"Mededeling aan het publiek bij aanklikbare link op toegankelijke site", *IE Forum*, IEF 12808, 27 June 2013, via <http://ie-forum.nl/?/////12808>

## Reports and communications

Report from the European Commission on the application of Council Directive 92/83/EEC on the coordination of certain rules concerning copyright and rights related to copyright applicable to satellite broadcasting and cable retransmission, COM(2002) 430 final, 26 July 2002.

Communication from the Commission to the Council, the European Parliament and the European Economic and Social - Committee "The Management of Copyright and Related Rights in the Internal Market", Brussels, 16 April 2004, COM (2004) 261 final.

European Commission, "A Single Market for Intellectual Property Rights, Boosting creativity and innovation to provide economic growth, high quality jobs and first class products and services in Europe", Brussels, 24 May 2011, COM(2011) 287 final, p.11, at [http://ec.europa.eu/internal\\_market/copyright/docs/ipr\\_strategy/COM\\_2011\\_287\\_en.pdf](http://ec.europa.eu/internal_market/copyright/docs/ipr_strategy/COM_2011_287_en.pdf)

European Commission, "Green Paper on the online distribution of audiovisual works in the European Union: opportunities and challenges towards a digital single market", COM(2011) 427 final, Brussels, 13 July 2011, accessible via [http://ec.europa.eu/internal\\_market/consultations/docs/2011/audiovisual/green\\_paper\\_COM2011\\_427\\_en.pdf](http://ec.europa.eu/internal_market/consultations/docs/2011/audiovisual/green_paper_COM2011_427_en.pdf). The contributions to the public consultation can be found at [http://ec.europa.eu/internal\\_market/consultations/2011/audiovisual/](http://ec.europa.eu/internal_market/consultations/2011/audiovisual/).

# **The re-transmission of copyright-protected content in digital networks**

## **The right of retransmission by cable**

By Sari DEPREEUW (PhD) (De Wolf & Partners) and Jean-Benoît HUBIN (De Wolf & Partners)

Under the supervision of Jean-Paul TRIAILLE (De Wolf & Partners, Lecturer, University of Namur)

August 2013

The authors thank the following persons for their valued contributions to this Study: Maciej BARCZEWSKI (attorney-at-law, and Head of Postgraduate Program in Intellectual Property and High Technology Law, University of Gdansk), Stéphanie CARRÉ (Maître de Conférences, CEIPI, Université de Strasbourg), Estelle DERCLAYE (Professor of Intellectual Property Law, Faculty of Social Sciences, University of Nottingham), Giuseppe MAZZIOTTI (Center for European Policy Studies), Peter MEZEI (Assistant Professor at University of Szeged), Sylvie NÉRISSON (Max Planck Institute for Intellectual Property and Competition Law, Munich), Thomas RIIS (Professor at University of Copenhagen, Faculty of Law), Raquel XALABARDER PLANTADA (Vicerectorat d'Ordenació Acadèmica i Professorat Directora Adjunta, Universitat Oberta de Catalunya).

The responsibility for this Study and for the opinions expressed herein remains with his author(s).



## I. Terms of Reference

The Terms of reference for this part of the Study are the following:

### **The territoriality of online rights in the Single Market**

The protection of copyright and related rights in the EU is "territorial" in the sense that the recognition and enforcement of rights occurs on a country by country basis (nevertheless, the management of rights does not need to be territorial and right-holders are often in a position to grant multi-territorial licences). The balance between territoriality and the functioning of the internal market has been achieved, as far as the distribution of physical copies is concerned, by the principle of exhaustion developed by the CJEU and, as far as the act of communication to the public by satellite is concerned, by the definition of where the act takes place (one single Member State, often referred to as "country of origin" or uplink) in the Satellite and Cable Directive.

The main right applicable to on-line transmissions – the so-called "making available" right provided under Article 3 of the InfoSoc Directive – remains territorial in the sense that the act of making available is in all likelihood an act relevant in each of the Member States where the content is accessed (plus, probably, the country in which the content is uploaded). The question has arisen as to whether this is sustainable for the functioning of the internal market, and whether alternative approaches would not be more appropriate - in particular whether the "making available" should not be re-considered as a relevant copyright act only in the Member State in which the relevant online service originates/the service provider is established. This approach is similar to that applied in the copyright 'acquis', to the act of communication to the public by satellite. The reproduction right is equally relevant, certainly in the case of downloads where clearly an act relevant for copyright purposes would happen (independently of where the act of "making available" is defined as taking place) in each of the countries where end users download digital files. This is an aspect that did not arise in the context of satellite broadcasting.

### **Re-transmission of copyright-protected content in digital networks**

A specific regime for cable retransmission is established in Chapter III of the Satellite and Cable Directive (compulsory collective management with an extended effect). New digital platforms have enabled programmes to be retransmitted simultaneously across different networks. Operators of DSL, IPTV, mobile networks and other digital platforms also operate broadcast retransmission services. Some operators now propose a wireless distribution of the programmes after their transmission or retransmission by cable. The act of retransmission by Internet of a broadcast is normally referred to as "simulcasting". The question arises as to whether the technology-specific provisions of Chapter III of the Satellite and Cable Directive need to be reviewed to develop a framework for retransmission of content that is technology neutral with regard to the delivery platform. In that context, stakeholders have pointed to differences and confusion in terms of the categorisation of rights and applicable rights clearance mechanisms, and a need for more clarity and legal certainty. A relevant question is the extent to which one can assimilate the act of retransmission by digital networks with the traditional act of retransmission by cable e.g. in terms of business model and breadth of access (the compulsory collective management of cable retransmissions rights established in the Sat Cab Directive is limited to retransmission of a broadcast – coming from another Member State - within the territory of a Member State; this is not likely to be the case in an Internet-based retransmission scenario).

### **Output to be achieved**

With regard to the question of retransmission of broadcast services (by satellite, cable and internet), the Study should (a) provide an overview of provisions at national level and relevant case law at national and



EU level, assessing in particular the extent to which there is a consistent interpretation of the "communication to the public" and "making available" rights across the EU (taking into account the hybrid nature of many services); and equally whether a consistent distinction is made between "primary broadcast" and "retransmission"; and (b) assess whether an update to Chapter III of the Satellite and Cable Directive is needed, including the clarification of the relevant acts (and services) covered by the Directive.

It has been discussed with the Commission that the Study should focus on the **notion of "cable retransmission to the public"**, in particular the notions of the "initial transmission by wire or over the air" and the "retransmission by cable or microwave system for reception by the public". In particular it should be verified how these notions are interpreted, both at the European and the national levels, with regard to the qualification of transmissions of works ("primary" and "secondary" transmissions, technologies).

## II. The cable retransmission right

This Study examines some questions regarding the right of retransmission by cable. After an introduction of the topic and the questions (*sub A*), the cable retransmission right as dealt with in the SatCab Directive will be analysed (*sub B*). We will discuss the provisions in the SatCab Directive, analyse the definition of the cable retransmission right and identify the constitutive elements. It will be verified how the cable retransmission right is applied in the national courts.

### A. Introduction

The broadcasting of radio and television programmes (containing copyright works) has been protected for a long time<sup>382</sup>. A broadcasting right has been introduced in the Berne Convention at the Rome Conference of 1928 (current art. 11bis (1)(i) BC). The rights of communication to the public of broadcast works have been adopted at the Brussels revision of 1948 (art. 11bis (1)(ii-iii) BC). Since then the broadcasting and transmission technologies have evolved a fair deal. When the broadcasting right was first adopted, radio and television programmes were transmitted by Hertzian waves. Cable operators could distribute these programmes by capturing this broadcast Hertzian signal by means of an antenna and introducing these signals in their cable networks in order to bring the radio or television programmes to the connected radio or television sets. At that time it was clear that a "broadcast" was a wireless transmission to a public and that other communications to the public (by cable) were not "broadcasts".

New technologies have made it possible to establish similar mass communications in various technical constellations. Satellites can be used to broadcast programmes to a public in possession of an antenna and, if necessary, a decoder. Satellite technology can also serve to transport content between professional distributors, so the programmes can be further distributed over the cable networks. The same direct communication can be operated by means of professional platforms or "direct injections", which allow bypassing the reception of the initial broadcast and the subsequent injection of the (modified) signal into the cable network. In Member States with a dense cable network, it is common for some "broadcasters" no longer to emit their programmes via a wireless signal, but to serve their programmes to the public by cable only.

---

382 Berne Convention for the Protection of Literary and Artistic Works of September 9, 1886, completed at Paris on May 4, 1896, revised at Berlin on November 13, 1908, completed at Berne on March 20, 1914, revised at Rome on June 2, 1928, at Brussels on June 26, 1948, at Stockholm on July 14, 1967 and at Paris on July 24, 1971 and amended on September 28 1979 (hereafter the "Berne Convention" or "BC"); Council Directive 93/83/EEC of 27 September 1993 on the coordination of certain rules concerning copyright and rights related to copyright applicable to satellite broadcasting and cable retransmission, Official Journal L 248 , 06/10/1993, 15-21 (hereafter "SatCab Directive" or "SatCab Dir").

In our era the technical possibilities to operate a (linear) communication to the public have multiplied. Television and radio shows can be watched in real time via internet (WIFI or cable), on a computer or other (handheld) devices, or via mobile technology, on a “smart phone” or “tablet”. The public now has many ways to watch “television” or listen to the “radio” and they have access to various “bundles” offered by various economic operators (cable operators/internet service providers; “broadcaster”/internet content provider).

It seems the convergence of technologies has affected our vocabulary: the use of wireless technology is no longer tantamount to a “broadcast”, a “broadcaster” (at least in common language) does not necessarily serve its public over the air and a viewer could be watching “television” on her computer or her phone.

The legal terminology, by contrast, has not evolved beyond the cable and satellite technologies. The Berne Convention and the Satellite and Cable Directive define specific forms of communication to the public, while the Information Society Directive provides a general right of communication to the public. It is not always straightforward to apply the existing legal framework to a technically more advanced sector.

The traditional cable retransmission of a broadcast programme, as originally thought of in the Berne Convention, consists of an initial broadcast (by wireless means), which is captured by the cable operator, transformed into a cable signal and then retransmitted to the public via the cable network. This technical scheme can be represented as follows:

## “Traditional” retransmission by cable

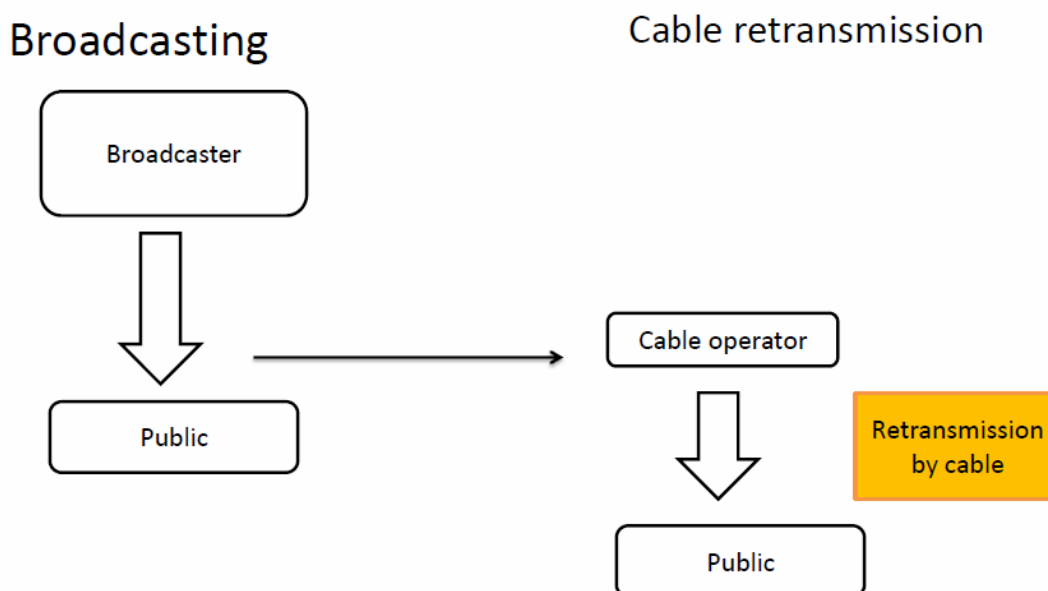

This transmission scheme is still used for the retransmission of free to air broadcasters’ programmes to cable subscribers (e.g. most of the European public broadcasters).

**Initial transmission.** Television programmes can be also brought to the cable subscribers following a direct communication between the “broadcasting organisation” and the cable operator. In this case, the transmission between the broadcaster and the cable operator may be performed by cable or by satellite and only the cable operator has access to these signals, as transmitted by the “broadcaster”. The initial transmission is not accessible to the general public. By contrast, the subsequent transmission via the cable network reaches a public, consisting of the cable subscribers.

In this scheme the cable transmission is technically independent from any broadcast. Some broadcasters may broadcast their programmes over air and, in parallel, transfer the programme signals to the cable operator, which transmits the programme to the cable subscribers simultaneously with the broadcast. In other cases, there is no parallel broadcast: the “broadcaster” determines the content of the programmes and the schedule but it does not necessarily undertake a wireless transmission to the public (hence the quotation marks).

## Cable re/transmission?

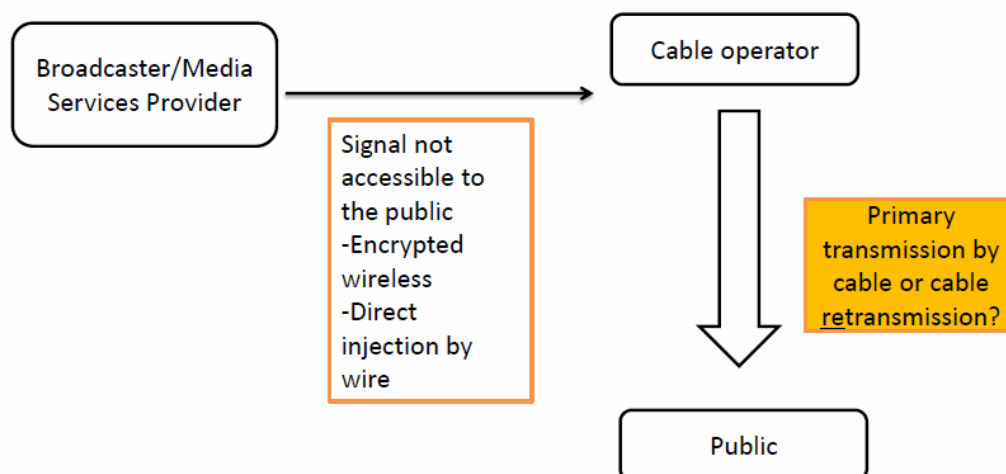

Examples of such cable transmission, following a direct transmission between the “broadcaster” and the cable operator, can be found in Belgium, The Netherlands or Denmark.

**Essentially, the question is when a first transmission is qualified as an “initial transmission” in the sense of the SatCab Directive and how it affects the qualification of the subsequent cable transmission.** The first transmission will determine whether the communication by cable should be considered a “cable retransmission” in the sense of the SatCab Directive or as an independent communication to the public by cable.

The issues here are 1) whether the first transmission between the “broadcaster” and the “cable operator” can be qualified as an “initial transmission” in the sense of the SatCab Directive and 2) whether a simultaneous but parallel transmission by cable, which is technically independent of the broadcast, can

be qualified as a “retransmission by cable”. This qualification of the first and the second transmissions has certain legal consequences (in particular the mandatory collective management of the cable retransmission right).

**Retransmission by cable.** Television and radio programmes are not only accessed via the traditional cable network, they can also be transmitted to the public by means of other technologies. These could be local networks, which are not installed by a traditional cable distributor but by alternative operators (e.g. in hotels). Or the programmes are channelled to the public via alternative networks, such as the Web or the mobile network.

In this scheme there may be an initial transmission in the sense of the SatCab Directive. There is also a subsequent transmission to a public. However, the question is whether the secondary transmission can be qualified as a “retransmission by cable” if it is not operated via a traditional coaxial cable network, as known when the SatCab Directive was adopted. This transmission scheme can be represented as follows:

## Retransmission by “cable”

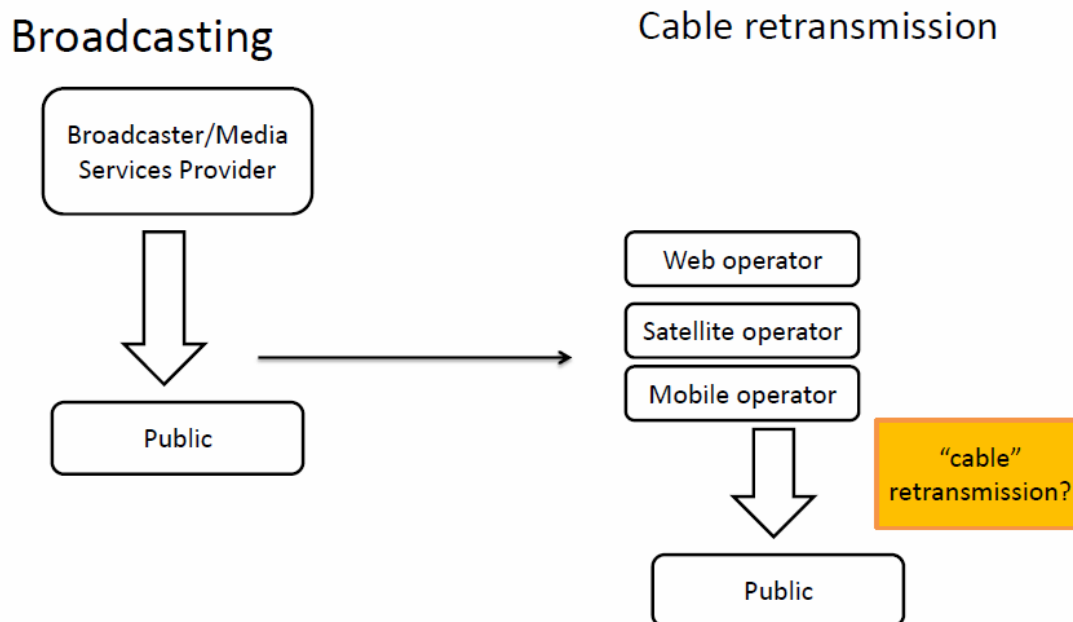

Examples can be found when a mobile operator offers “mobile television”, so the user may access the broadcast in real time via her mobile device, or when live streams of linear radio or television programmes are available via the Web.

**Essentially the question here is whether the “retransmission by cable” should be understood in a technology-specific or technology-neutral way.**

The issue here is whether the retransmission via another network than the traditional coaxial cable network can be qualified as “retransmissions by cable” in the sense of the SatCab Directive. Inversely, it is noticed that some transmissions via a local cable network are not qualified as a “retransmission by

cable” but as generic “communications to the public” instead. The qualification of such new transmission models has legal effects. Depending on whether or not the notion of “cable and microwave system” should be understood in a technology-specific way, the effects of the directive will apply (in particular the scope of the mandatory collective management).

Finally, brief reference may be made to the offer of certain cable distributors/internet providers to access broadcasts via the home network, using different devices (smart phones, computers, tablets). We will not treat this question in this Study, since the issue of those bundled services is whether a distinct act of communication to public is performed, rather than their qualification as a retransmission by cable in the sense of the SatCab Directive.

Having introduced the questions raised, we will proceed to a more detailed examination of the right of retransmission by cable. We will first briefly describe the legal context of the European initiative to regulate the right of retransmission by cable of programmes originating in another Member State. We will then discuss the constitutive elements of the definition of the right of retransmission by cable.

We will not discuss the legal consequences of the qualification as a cable retransmission, i.e. the mandatory collective management of the cable retransmission right, neither the exception in favour of the broadcasting organisations, nor the issues surrounding the “all rights included” contracts. The provisions regarding the mediation will be left untouched as well.

## **B. Cable retransmission right in the SatCab Directive**

Before examining the definition of the cable retransmission right in the SatCab Directive (*sub 2 and 3*), we will briefly describe the legal context in which this particular regime should be understood (*sub 1*). We will point out the provisions in the Berne Convention and the origin of the SatCab Directive, including considerations that urged the European legislature to regulate this issue.

### **1. Legal context**

The issue of cable retransmissions was addressed in the Berne Convention, before the SatCab Directive was adopted. The Berne Convention treats it in a provision regarding the broadcasting rights (art. 11bis BC).

The Berne Convention provides, for authors, a broadcasting right and “related” rights, i.e. the right of communication to the public of the broadcast of the work (by an organisation other than the original one) and the public communication by loudspeaker or any other analogous instrument transmitting, by signs, sounds or images, the broadcast of the work (art. 11bis (1)(i)-(iii) BC). The members of the Berne Union are however free to regulate the exercise of these rights, provided that the limitations to the broadcasting rights and the related rights only apply on the territory of that country (art. 11bis (2) BC)<sup>383</sup>.

---

383 Article 11bis Broadcasting and Related Rights:

1. Broadcasting and other wireless communications, public communication of broadcast by wire or rebroadcast, public communication of broadcast by loudspeaker or analogous instruments; 2. Compulsory licenses; 3. Recording; ephemeral recordings

(1) Authors of literary and artistic works shall enjoy the exclusive right of authorizing:

(i) the broadcasting of their works or the communication thereof to the public by any other means of wireless diffusion of signs, sounds or images;

(ii) any communication to the public by wire or by rebroadcasting of the broadcast of the work, when this communication is made by an organization other than the original one;

(iii) the public communication by loudspeaker or any other analogous instrument transmitting, by signs, sounds or images, the broadcast of the work.

(2) It shall be a matter for legislation in the countries of the Union to determine the conditions under which the rights mentioned in the preceding paragraph may be exercised, but these conditions shall apply only in the countries where they have been prescribed.

At the time the broadcasting rights were regulated in the Berne Convention, the primary act of broadcast was characterised by a dispatch of signals by Hertzian waves. It was said essential that “*no intermediary body interposes between the emitting antennae and the aerial at the receiving point*”<sup>384</sup>. If the transmission to the public was operated via the cable network, then there was no broadcast but a primary communication to the public by wire, addressed in art. 11 BC (not 11bis BC).

The primary broadcast was distinguished from the secondary retransmission by the (possible) intervention of other organisations than the broadcaster. It was considered that “*the same programme may be transmitted on the usual wavelength and simultaneously by VHF; what matters is that the whole operation is carried out by one and the same organisation*”<sup>385</sup>. A secondary communication to the public (by wire or not) was found if it was carried out by another organisation than the one that broadcast the programmes. This secondary communication was then distinguished from the (primary) communications to the public by wire (in art. 11(1) BC): the latter covered the cases where the cable operator transmitted its own programmes and the former referred to the cases where the cable operator transmitted someone else’s broadcasts.

The Berne Convention was thus written to the size of a specific constellation of technologies and institutional actors. The mode of transmission (by wire or wireless) was decisive, as was the identity of the transmitting body (original broadcasting organisation or other organisation).

At the European level, the cable retransmission is regulated in Directive 93/83 on satellite broadcasting and cable retransmission.

The harmonisation of these rights was deemed necessary<sup>386</sup>, given the unequal level of protection between Member States, the legal uncertainty as to the protection and the need of a certain level of protection for authors and holders of neighbouring rights (including the consideration that many individuals are involved in the creation and production of audiovisual works, many of whom have exclusive rights and hence the possibility of blocking the exploitation of the work, thus harming the interests of the other right holders). The Directive was indeed meant to contribute to the realisation of the audiovisual internal market.

The SatCab Directive deals with two types of rights: the right of communication to the public by satellite and the right of retransmission by cable. While the satellite broadcasting right is not the focal point of this Study, it may pop up occasionally: transmissions by satellite and by cable may be integrated in a technical scheme to reach a public and the qualification of the cable transmission as a cable retransmission in the sense of the Directive may depend on the qualification of the communication (to the public or private) by satellite. The discussion of the satellite communications will consequently be incidental to the examination of the communication by cable.

---

They shall not in any circumstances be prejudicial to the moral rights of the author, nor to his right to obtain equitable remuneration which, in the absence of agreement, shall be fixed by competent authority.

(3) In the absence of any contrary stipulation, permission granted in accordance with paragraph (1) of this Article shall not imply permission to record, by means of instruments recording sounds or images, the work broadcast. It shall, however, be a matter for legislation in the countries of the Union to determine the regulations for ephemeral recordings made by a broadcasting organization by means of its own facilities and used for its own broadcasts. The preservation of these recordings in official archives may, on the ground of their exceptional documentary character, be authorized by such legislation.

384 Guide to the Berne Convention for the Protection of Literary and Artistic works (Paris Act, 1971), World Intellectual Property Organisation, Geneva, 1978, 67 (hereafter Guide to the Berne Convention 1978).

385 Guide to the Berne Convention 1978, 67.

386 Proposal for a Council Directive on the coordination of certain rules concerning copyright and neighbouring rights applicable to satellite broadcasting and cable retransmission, Explanatory Memorandum, COM(91) 276 final – SYN 358, 1991, 20 (hereafter SatCab Proposal).

Attention should be paid to the technical and commercial context in which the first discussions on the SatCab Directive were held<sup>387</sup>.

Technically, the “retransmission by cable” referred to the transmission of signals that were broadcast to the attention of the public and captured by the cable operator, before being transmitted via the cable network to the public of cable subscribers<sup>388</sup>. This was translated in a technical scheme, where the broadcasters communicated their programmes via terrestrial means or satellite so their public could receive the programmes<sup>389</sup>. This scheme was not substantially different than the one in the Berne Convention. The Commission considered that *“there is no cable retransmission in the sense of this proposal, if the programme is merely delivered by point-to-point communication to the cable head end without being subject to a simultaneous primary broadcast”*<sup>390</sup>. The notion of “cable retransmission” extended to *“multipoint micro-wave distribution systems where the latter perform the role of broadcast retransmission in areas where the establishment of a cable network is not economically viable”*<sup>391</sup>. This system was installed in Ireland.

It was underscored that the primary broadcaster decided the timing and the content of the programme and that it has the opportunity to clear all the rights involved on an individual basis<sup>392</sup>. Cable operators merely retransmitted another party’s primary broadcast – at the same time as the original broadcast and without modifying the programmes). It was explained: *“for copyright purposes, however, a distinction has to be drawn between primary broadcasting and the simultaneous, unabridged retransmission of programmes by cable. In a primary broadcast, which includes the broadcast of an original programme via satellite, the broadcaster himself decides the composition of the programme. He will include only works and protected performances for which he has already secured the broadcasting rights. In cable retransmission, on the other hand, the cable operator cannot make up his programmes on the basis of a portfolio of rights which he has acquired beforehand. The cable operator can decide only whether he wants to retransmit the primary broadcast in full or not at all”*<sup>393 394</sup>.

The distinction between the primary broadcast and the secondary retransmission was not a merely theoretic division: it had practical consequences, in particular for the acquisition of rights. It was **decisive** that the **primary broadcasters determine the timing and the content of the programmes** and it was derived from this circumstance that they had sufficient time to acquire the right holders’

---

387 Discussion Paper “Broadcasting and copyright in the internal market”, prepared by the Commission of the European Communities on copyright questions concerning cable and satellite broadcasts, III/F/5263/80-EN, November 1990, 26-35 (hereafter “Discussion Paper”).

388 In the Discussion Paper, a distinction was found between the retransmission of terrestrial broadcasts and the retransmission of satellite broadcasts. In the former case, the cable retransmission rights were acquired in collective agreements and for a lump sum (given the dependence on the primary broadcast), unless the national copyright legislation provided a statutory licence. In some countries there was no cable retransmission on a significant scale. As far as retransmission of satellite broadcasts was concerned, the same legal principle applied, i.e.; a consent was required for the retransmission by cable. However, in practice, the satellite broadcasters acquired the cable retransmission rights for the territory of its satellite’s footprint and then concluded further contracts with the cable operators. Yet both types of retransmissions were considered secondary communications, re-broadcasts rather than broadcasts.

389 Cf. the graphic representation of the broadcasting and retransmission schemes, as an annex to the Discussion Paper.

390 SatCab Proposal, 36.

391 SatCab Proposal, 36.

392 Discussion Paper, 56.

393 SatCab Proposal, 20.

394 See also: Discussion Paper, 56-57. “This retransmission is entirely dependent on the primary transmission. The cable operator can decide only whether or not he wants to retransmit the primary broadcast, he has no way of shaping or influencing the content of the programme. This dependence on the primary broadcast also means that the cable operator does not have long advance notice of the components of the programme and particularly of any changes. Unlike the primary broadcaster, therefore, the cable operator is not in a position to take timely steps to ensure that he has the rights necessary for simultaneous, unaltered and unabridged retransmission from each individual right owner. He has very little time to clarify any disputed points of law and as a rule he will be unable to switch to other programmes, for technical reasons or on legal grounds such as a legal obligation to transmit programmes in their entirety”.

consent on an individual basis<sup>395</sup>. By contrast, it was impossible for a cable operator to acquire the rights in the same way, on an individual basis<sup>396</sup>. The cable network operator, which takes over a primary broadcast without alteration and without having a say in the composition of the programmes it relays, is not in a position to identify the owners of rights in particular parts of the programme in advance. It was **dependent on the primary broadcast**, which was captured and then transmitted to the cable subscribers, hence it could not know in advance which rights to clear (for television or radio programmes composed by the primary broadcaster).

The Directive was meant to address this problem in a uniform way (at least for retransmissions coming from another Member State), i.e. by means of a **mandatory collective management** of this right. By consequence, the central exercise of these rights by one or more collecting society was proposed, “*in order to prevent rights in individual programme components from standing in the way of the cable retransmission operation as a whole*”<sup>397</sup>. Moreover, the Directive was meant to solve the “outsider problem”. In many Member States, collective agreements were concluded to deal with the cable retransmissions of broadcast programmes (even before the adoption of the directive). However, the cable operators still faced the uncertainty of “outsiders”, i.e. right holders who are not affiliated to and therefore not represented by the contracting collecting societies and who therefore still have the possibility of claiming remuneration or blocking the exploitation by an action for injunction.

Finally, attention was given to the particular situation of the **broadcasting organisations**. An exception to the mandatory collective management was thought appropriate for broadcasting organisation. These were entitled to exercise their cable retransmission rights themselves, without the mandatory intervention of collecting societies. It was considered that the cable distributor did not encounter the same difficulty in acquiring all necessary rights before transmitting the programmes when dealing with broadcasting organisations. Since the cable operator knew which broadcasters’ programmes it would retransmit, it had the possibility to acquire the cable retransmission rights from those broadcasters prior to the retransmission of their programmes (provided the broadcaster held the cable retransmission rights), especially considering that there was only a limited number of broadcasting organisations. The intervention of a collecting society was not considered necessary to ensure a complete transfer of rights. The broadcasting organisation thus had the right to conclude a contract on the cable retransmission in relation to its own rights and to rights assigned to it: “*where a right owner transfers the rights for a primary broadcast and for any associated cable retransmission to a broadcasting organisation, these cable retransmission rights are to be exercised by the broadcasting organisation and not by a collecting society*”<sup>398</sup>.

In whole, the conclusion of the analysis was that the conclusion of contracts (negotiation, renegotiation) could pose a problem. The solution adopted in the Directive aims at facilitating contracts, on the one hand by imposing the exercise of the cable retransmission right via collective agreements, on the other hand by shaping a system of impartial mediators.

## 2. Cable retransmission right v right of communication to the public

Before examining the notion of cable retransmission, as defined in the SatCab Directive, it is worth paying attention to the relation between the cable retransmission right and the right of communication to the public. The CJEU has issued several decisions in cases where some kind of transmission by cable is at stake<sup>399</sup>.

---

395 Discussion Paper, 78-79.

396 Explanatory Memorandum, SatCab Proposal, 23.

397 Explanatory Memorandum, SatCab Proposal, 43.

398 Explanatory Memorandum, SatCab Proposal, 44.

399 CJEU, 7 December 2006, C-306/05, SGAE v. Rafael Hoteles (SGAE). CJEU, Order of the Court of 18 March 2010, C-136/09, Organismos Sillogikis Diacheirisis Dimiourgou Theatrou kai Optikoakoustikon Ergon v Divani Akropolis Anonimi Xenodocheiaki kai Touristiki Etairea (Organismos Sillogikis); CJEU 7 March 2013, Case C-607/11, ITV Broadcasting Ltd and Others v TV Catch Up



Most of these cases resulted from the reception of television or radio signals by hotels and their distribution by cable in the bedrooms of the hotels. The Court has not always analysed these cases on the basis of the cable retransmission right in the SatCab Directive, but as acts of communication to the public instead, as harmonised by the InfoSoc Directive<sup>400</sup>.

The SatCab Directive does not impose, as such, an obligation for the Member States to provide a right of cable retransmission: it requires that, in case of a retransmission by cable from another Member State, the copyrights and related rights be observed (art. 8 SatCab Dir and Egeda, par. 24, opinion of Advocate-General La Pergola in Egeda, par. 14<sup>401</sup>). It is however assumed that such act is covered by an exclusive right (rec. 27 SatCab Dir). Since the adoption of the InfoSoc Directive, such cable retransmissions are considered to be protected as communications to the public (art. 3 InfoSoc Dir)<sup>402</sup>.

The cable retransmission right is indeed treated as a species of the right of communication to the public<sup>403</sup>. Where the court was asked to find whether a restricted act takes place, it answered by reference to the general right of communication to the public, given the fact that the SatCab Directive was intended to provide a partial harmonisation of certain aspects regarding the cable retransmission right (i.e. its exercise). Furthermore, the objective of the Cable and Satellite Directive laid down in the preamble was to secure free retransmission of channels within the EU by ensuring legal certainty, and not to regulate transmissions of a national range.

The Court was first questioned about the interpretation of the concept of cable retransmission as laid down in the SatCab Directive in the case *Egeda v. Hoasa*.

Hoasa owned a hotel in Spain in which a system was installed for the reception of terrestrial and satellite television programmes which it then retransmitted internally through coaxial cables to the TV in the rooms of the hotel. Egeda is the Spanish collecting society that manages the rights of audiovisual producers. It claimed for an infringement of its members' rights because Hoasa had no authorisation for the installation of such a system. Consequently, Egeda brought a claim against Hoasa to suspend the retransmission of the programmes in the hotel rooms.

Hoasa disputed that it had made any 'communication to the public' or 'cable retransmission' within the meaning of Article 1 of the Satellite and cable Directive.

The Spanish courts asked the Court of Justice to define whether the reception by a hotel establishment of satellite or terrestrial television signals and their distribution by cable to the various rooms of that hotel constituted an "act of communication to the public" or "reception by the public" in the sense of the Directive. The Spanish legislator had transposed the definitions of 'communication to the public by satellite' and 'cable retransmission' of the SatCab Directive literally into the Spanish copyright act.

The Court declined to answer this question. It considered (Egeda, par. 24-25): "*It is clear from Article 8 of the Directive, and from the 27th recital in the preamble, that the Directive neither requires the Member States to introduce a specific cable retransmission right nor defines the scope of any such right. It merely imposes an obligation upon the Member States to ensure that when programmes from other Member States are retransmitted by cable in their territory the applicable copyright and related rights are observed. It is clear from the foregoing that Article 1(2)(a) and (3) of the Directive does not provide information to enable the Court to answer the question whether the reception by a hotel establishment of*

---

Ltd (TV Catch Up). See also CJEU, 15 March 2012, C-162/10, Phonographic Performance v. Ireland (Phonographic Performance) on the right of communication to the public in the Rental and Lending Directive 2006/115.

400 Directive 2001/29/EC of the European Parliament and of the Council of 22 May 2001 on the harmonisation of certain aspects of copyright and related rights in the information society, Official Journal L 167, 22/06/2001, 10-19 (hereafter also "InfoSoc Directive").

401 CJEU 3 February 2000, C-293/98, *Egeda v. Hoasa* (Egeda).

402 See P.B. HUGENHOLTZ, « SatCab Revisited : the past, present and Future of the Satellite and Cable Directive », *IrisPlus* 2009/8 (7), 16. See Egeda, par. 26-28.

403 see SGAE, par. 30; TV Catch Up Ltd, par. 24.

*satellite or terrestrial television signals and their distribution by cable to the various rooms of that hotel constitutes an 'act of communication to the public' or 'reception by the public'.*"

That prejudicial issue was addressed to the Court of Justice before the adoption of the InfoSoc Directive, which was considered the appropriate framework to answer the Spanish court's question. The SatCab Directive provided for only a minimum degree of harmonisation (Egeda, par. 17).

The Advocate General was more willing to provide an answer to the national court<sup>404</sup>. As is the case in Spain, cable retransmission is generally considered a restricted act under the law of copyright in all Member States<sup>405</sup>. Advocate general La Pergola held the opinion that the SatCab Directive was not so much concerned with the definition of the protected act, but with the exercise of this right. An interpretation of the notion of cable retransmission could be found in the Berne Convention:

*"(...) in the case of cable retransmission (...) the Directive does not in this case require the introduction of an analogous exclusive right but assumes that other rights exist in national law ('copyright and related rights') which have not been harmonised or defined, but observance of which the Member States must ensure (Article 8). I would therefore observe that for the purpose of this Opinion, the subject matter of the main action — the interpretation of broadcasting rights as regards communication to the public by cable of a protected work that has already been broadcast — lies outside the material scope of the Directive, which merely states that this right may be exercised only through a collecting society (Article 9).*

*As the scope for such co-ordination by the Community legislature is of course limited, it is clear why the Directive — which devotes all of Article 1 (Definitions) to clarification of the meaning of a number of fundamental terms used in the rest of the Directive, for the purposes of ensuring the application of its substantive provisions, ('for the purpose of this Directive') — does not define 'retransmission', 'cable system', 'public', 'communication to the public' or 'reception by the public' (see footnote 5, above). The definitions simply did not seem to be necessary. However, their meaning may be elicited from the international agreements on this subject, including of course the Berne Convention, which, as the Commission has stated, is the original source of many of the terms subsequently used in the Directive. I therefore agree with the applicant and the German, French and United Kingdom Governments that even if we admit that the main action concerns television programmes from other Member States, the preliminary ruling requested by the Juzgado de Primera Instancia e Instrucción n. 5 de Oviedo cannot be given on the basis of the Directive." (opinion in Egeda, par. 14-15)*

The Opinion of Advocate general La Pergola was thus based on art. 11bis of the Berne Convention. He stated (opinion in Egeda, par. 20-24):

*"(...) under the Convention, the grant of a television broadcast licence to a broadcaster does not cover any other use of the work — for example, communication to the public of the transmitted programme via loudspeakers or analogous instruments (in this case via television) — by third parties, particularly if this is for profit. This form of communication enables a new public to be reached which differs from the public the author had in mind when he first authorised broadcast in the exercise of his own exclusive right.*

*(...)*

*What criterion do I therefore suggest that the Court should adopt in the matter before it to distinguish between communications that are to the public and those that are not? In my opinion, the Convention lays down the principle that the author must authorise all secondary use of the broadcast work if this gives rise to independent economic exploitation for financial profit by the*

---

404 Opinion of the Advocate General La Pergola delivered on 9 September 1999 in case C-293/98.

405 B. HUGHENOLTZ, "Convergence, Copyrights and Transfrontier Television", Iris plus, 2009/8, 16.

*person responsible and also relates to the economic importance of the new public (paragraph 22 above), which is the group of persons to whom the particular act of communication via the television is addressed.”*

The Advocate General concluded (opinion in Egeda, par. 27):

*“I therefore believe that when deciding the main action, the court which made the reference for a preliminary ruling must apply the principle whereby the retransmission by a hotel of a work broadcast by satellite or terrestrial television signals from another Member State to its guests via the televisions in each of its rooms constitutes communication to the public and therefore must be separately authorised by the copyright holders of the protected work.”*

The InfoSoc Directive was then adopted on 22 June 2001. Recital 23 of the Directive expressly provides that the right of communication to the public “*should cover any transmission or retransmission of a work to the public by wire or wireless means, including broadcasting*”.

Consequently, following the opinion of Advocate general La Pergola and the decision of the CJEU in Egeda, the prejudicial issues addressed to the Court of Justice regarding a cable retransmission of television programmes were based on the notion of “communication to the public” as provided by article 3 of the InfoSoc Directive.

In 2006, the Court of Justice was once again questioned by a Spanish Court over a case resulting from the retransmission of television programmes to hotel bedrooms. The company Rafael owned a hotel in which it used television sets and played ambient music for distribution by cable in the rooms. SGAE, the collecting society managing the authors’ rights in Spain, took the view that Rafael’s activities involved a communication to the public of works belonging to its repertoire.

That case was exclusively treated on the basis of the right of communication to the public, and the Court did not interpret the notion of cable retransmission, declaring (SGAE, par. 30):

*“It should be stated at the outset that, contrary to Rafael’s submissions, the situation at issue in the main proceedings does not fall within Council Directive 93/83/EEC of 27 September 1993 on the coordination of certain rules concerning copyright and rights related to copyright applicable to satellite broadcasting and cable retransmission (OJ 1993 L 248, p. 15), but within Directive 2001/29. The latter applies to all communications to the public of protected works, whereas Directive 93/83 only provides for minimal harmonisation of certain aspects of protection of copyright and related rights in the case of communication to the public by satellite or cable retransmission of programmes from other Member States. As the Court has already held, unlike Directive 2001/29, this minimal harmonisation does not provide information to enable the Court to reply to a question concerning a situation similar to that which is the subject of the questions referred for a preliminary ruling.”*

The Court found that the clientele of a hotel may constitute a new public and stated that the distribution of a signal by means of television sets by a hotel to customers staying in its rooms, whatever technique is used to transmit the signal – thus also in case of cable retransmission – constitutes communication to the public within the meaning of Article 3(1) of the InfoSoc Directive (SGAE, par. 42):

*“The transmission of the broadcast work to that clientele using television sets is not just a technical means to ensure or improve reception of the original broadcast in the catchment area. On the contrary, the hotel is the organisation which intervenes, in full knowledge of the consequences of its action, to give access to the protected work to its customers. In the absence of that intervention, its customers, although physically within that area, would not, in principle, be able to enjoy the broadcast work.”*

The Court thus concluded that there was a new act of communication to the public (subsequent to the broadcast of the work), but it did not qualify it as an act of retransmission by cable, which would require mandatory collective management.

The Court confirmed that statement in a later case, *Organismos Sillogikis*, once again resulting from the distribution of television programmes to hotel rooms.

More recently, in the case *Phonographic Performance v. Ireland*, the Irish collecting society for the rights of phonogram producers (PPL) brought an action against Ireland. It alleged that the Irish legislation allowed operators of hotels and guesthouses not to pay an equitable remuneration for the distribution in the bedrooms, by cable or other technology, of received centrally television or radio signals. PPL considered that the Irish legislation infringed the right to equitable remuneration as defined in Directive 2006/115. In its judgment, the Court of justice confirmed once again that a hotel operator which provides in guest bedrooms televisions and/or radios to which it distributes a broadcast signal is a 'user' making a 'communication to the public' (*Phonographic Performance*, par. 47).

Finally, the Court recently delivered a judgment in a case resulting from the simultaneous retransmission on internet of television programmes in *TVCatchup*.

The company TVCatchup has developed an internet broadcasting television service available in the United Kingdom, according to which it offers its users the reception of free to air television broadcasts via internet live streams. TVCatchup ensures that the users receiving the TV programmes through its service have a TV licence. The service offered by TVCatchup is thus based on the following conditions:

- It is limited to free to air channels.
- It can only be accessed in the United Kingdom.
- The users must have a valid TV licence allowing them to watch television in the United Kingdom.

TVCatchup is able to control the respect of these conditions and to refuse the access to the users that would not comply with it. However, several commercial broadcasters retransmitted by TVCatchup brought a claim against TVCatchup for infringement of their copyright, alleging that the activities of TVCatchup imply a communication of their programmes to the public.

The Court of Justice analysed the lawfulness of TVCatchup's system of "cable retransmission" under the right of communication to the public. The Court defined the right of cable retransmission as a specific form of communication to the public and stated that the retransmission of a terrestrial television broadcast over the internet should be considered to be a 'communication' within the meaning of Article 3(1) of the InfoSoc Directive, as it consists in a transmission of the protected works which is different from that of the broadcaster. According to the Court (*TVCatchup*, par. 23-25):

*"It follows, in particular, from recital 23 in the preamble to Directive 2001/29 that the author's right of communication to the public covers any transmission or retransmission of a work to the public not present at the place where the communication originates, by wire or wireless means, including broadcasting. In addition, it is apparent from Article 3(3) of that directive that authorising the inclusion of protected works in a communication to the public does not exhaust the right to authorise or prohibit other communications of those works to the public.*

*If follows that, by regulating the situations in which a given work is put to multiple use, the European Union legislature intended that each transmission or retransmission of a work which uses a specific technical means must, as a rule, be individually authorised by the author of the work in question.*

*Those findings are, moreover, supported by Articles 2 and 8 of Directive 93/83, which require fresh authorisation for a simultaneous, unaltered and unabridged retransmission by satellite or cable of an initial transmission of television or radio programmes containing protected works, even though those programmes may already be received in their catchment area by other technical means, such as by wireless means or terrestrial networks."*

The Court then examined whether a public was reached by TVCatchup. It held that the technique used by TVCatchup, giving access to the works through a one-to-one connection did not prevent a large number of persons to have access to the same work at the same time, representing an indeterminate number of

potential recipients constituting a 'public' within the meaning of Article 3(1) of the InfoSoc Directive (TVCatchup, par. 39):

*"(...) the main proceedings in the present case concern the transmission of works included in a terrestrial broadcast and the making available of those works over the internet. As is apparent from paragraphs 24 to 26 above, each of those two transmissions must be authorised individually and separately by the authors concerned given that each is made under specific technical conditions, using a different means of transmission for the protected works, and each is intended for a public."*

In this case the retransmission was not operated via the traditional cable network but via the Web<sup>406</sup>. It would have been interesting to see if the Court considered such secondary exploitation via the Web a retransmission by cable in the sense of the SatCab Directive. Unfortunately, the core of the conflict was the existence of a secondary communication to the public, not its qualification and the exercise of rights.

Since the adoption of the InfoSoc Directive, the Court of Justice defines the right of cable retransmission as a fragment of the right of communication to the public. Meanwhile, the scope of the SatCab Directive is restricted to cable retransmission of an initial transmission of protected works *from another Member State*. Consequently, the regime of mandatory collective rights management established by the SatCab Directive does not necessarily apply to cases of purely national retransmission, for which the Member States keep their autonomy (within the limits of art. 11bis BC and considering that such cable retransmission is an act of communication to the public)<sup>407</sup>.

In the Nordic countries for instance, the mechanism of the extended collective licence covers simultaneous and unaltered cable retransmissions, both coming from another Member State and purely "domestic" ones<sup>408</sup>. According to this mechanism, if a collective rights management society concludes an agreement with a service provider, this agreement is valid not only for the authors and right holders represented by the organisation but also for works of non-represented right holders of the same category<sup>409</sup>. Specific provisions apply to the functioning of extended collective licences<sup>410</sup>.

**Summarising**, a cable retransmission as harmonised by the SatCab Directive is a specific form of communication to the public. The SatCab Directive was meant to harmonise only certain aspects in relation to this right, i.e. its exercise, but it does not require a specific right of retransmission by cable. Ever since the Information Society Directive was adopted, questions regarding the existence of a restricted act are answered by reference to the general right of communication to the public (art. 3 InfoSoc Directive).

---

406 In this context we also bring to the attention that another preliminary question has been submitted to the court in case C-416/12:

"Does the concept of communication to the public within the meaning of Article 3(1) of Directive 2001/29/EC include the rebroadcasting, by wire, of a broadcast work in the case where the original broadcast can also be received by wireless means in the catchment area, the work is rebroadcast to the owners of reception equipment who receive the broadcast personally or within their own private or family circles, and the rebroadcasting is carried out for profit-making purposes by a broadcasting organisation other than the original one?". Following the ruling of the CJEU in Case C-607/11, the German Supreme Court has withdrawn its question: see CJEU order of the President of the Court of 22 May 2013.

407 Cf. also the SatCab Proposal, 35.

408 Art. 35 (1) of the Danish Copyright Act:

Works which are broadcast wireless on radio or television may be retransmitted simultaneously and without alteration via cable systems and may in the same manner be retransmitted to the public by means of radio systems, provided the requirements regarding extended collective license according to section 50 have been met. The provision of the first sentence shall not apply to rights held by broadcasters.

409 J. ROSEN, "News from the Nordic countries", R.I.D.A., 2011, n° 229, 183. For a complete presentation of the extended collective licence mechanism, see J. AXHAMN and L. GUIBAULT, Cross-border extended collective licensing: a solution to online dissemination of Europe's cultural heritage?, 2011, retrieved via

[http://www.ivir.nl/publicaties/guibault/ECL\\_Europeana\\_final\\_report092011.pdf](http://www.ivir.nl/publicaties/guibault/ECL_Europeana_final_report092011.pdf).

410 Art. 50-52 of the Danish Copyright Act.

After having examined the scope of application of the SatCab Directive and its relation to the Information Society Directive, we will turn to the constitutive elements of the notion of “retransmission by cable”.

### 3. Elements of the “cable retransmission” (art. 1(3) SatCab Dir).

As explained, it is assumed that the retransmission by cable requires the right holders’ consent, but the SatCab Directive does not impose, as such, an obligation for the Member States to provide a right of cable retransmission. The question whether a particular cable transmission is protected is answered from the angle of the general right of communication to the public as harmonised in the InfoSoc Directive.

**Effects.** The SatCab Directive by contrast puts forward a regime for the exercise of the cable retransmission right (art. 8-12). When an act of communication to the public is qualified as a retransmission by cable, it follows that this right should be exercised as determined in the SatCab Directive.

The exercise of the cable retransmission right is subject to mandatory collective management (art. 9(1) SatCab Dir). This provision is meant to offer more protection to the right holders than the Berne Convention: under the Directive, the exclusive nature of this right is acknowledged, allowing right holders (be it through their collecting societies) to negotiate an agreement. Statutory licences, allowed under the Berne Convention, are not permitted under the SatCab Directive.

The “outsider problem” of right holders who have not transferred their rights to a collecting society has been solved by a presumption that the collecting society which manages rights of the same category is mandated to manage their rights. The Directive provides a system of extended collective licences (art. 9(2) SatCab Dir). This provision is considered giving a concrete expression to the rule of the mandatory collective management<sup>411</sup>.

The mandate of the collecting society is not limited to the financial aspects of the right, the exercise of the retransmission right as such is not excluded<sup>412</sup>.

An exception is made for broadcasting organisations in respect of their own transmissions, irrespective of whether the rights concerned are its own or have been transferred to it by other copyright owners and/or holders of related rights (art. 10 SatCab Dir).

The Directive also requires the Member States to provide a system of mediation, in case the interested parties do not manage to conclude an agreement (art. 11 SatCab Dir). Finally, the Member States should provide a mechanism to prevent the abuse of negotiating positions, forcing the parties to enter into and conduct negotiations in good faith and to refrain from preventing or hindering the negotiations without “valid justification” (art. 12 SatCab Dir).

**Definition.** This regime is only applicable if a “cable retransmission” between Member States is established. The cable retransmission is defined as the “*simultaneous, unaltered and unabridged retransmission by a cable or microwave system for reception by the public of an initial transmission from another Member State, by wire or over the air, including that by satellite, of television or radio programmes intended for reception by the public*” (art. 1(3) SatCab Dir).

The definition of “cable retransmission” refers to two transmissions:

- 1) an initial transmission by wire or over the air (including by satellite) for reception by the public of a radio or television programme and

---

411 CJEU 1 June 2006 Case C-169/05, *Uradex SCRL v Union Professionnelle de la Radio et de la Télédistribution (RTD) and Société Intercommunale pour la Diffusion de la Télévision (BRUTELE)*, par. 21 (“Uradex”).

412 *Uradex*, par. 22.

- 2) the retransmission of this initial transmission by a cable or microwave system for reception by the public.

The initial transmission could be any primary broadcast, without distinction regarding the mode of transmission<sup>413</sup>: it could be a primary broadcast by satellite or terrestrial means or even by wire. It was stated in the Explanatory Memorandum that *“however, there is no cable retransmission in the sense of this proposal, if the programme is merely delivered by point-to-point communication to the cable head end without being the subject of a simultaneous primary broadcast”*<sup>414</sup>.

The notion of cable retransmission covers retransmissions of the initial transmission, for reception by the public, via the cable network or multipoint microwave distribution systems, where these *“perform the role of broadcast retransmission in areas where the establishment of a cable network is not economically viable”*<sup>415</sup>. Unlike the Berne Convention, the Directive does not require that the cable retransmission be operated by another organisation than the broadcasting organisation.

In 2002, the Commission issued a report on the SatCab Directive<sup>416</sup>. With regard to the definition of the cable retransmission right, it was found that the transmission technologies were evolving.

The **primary broadcasts** were moving from terrestrial broadcasting technologies to satellite transmissions. As far as the **secondary transmissions** were concerned, it was found that these were often operated by microwave channel, via internet and by satellite. It was decided not to adapt the Directive to these technical evolutions<sup>417</sup>. It was found too early to adapt the Directive to the retransmission by microwave channel. Internet retransmissions should be assessed against the E-commerce Directive and the Infosoc Directive. The Commission found similarities between the retransmission by cable and the retransmission by satellite<sup>418</sup>, but it did not think it justified to extend the cable retransmission system to these forms of retransmission, given the larger impact of satellite transmissions. Since the geographic footprint of the satellite transmission is international while a cable retransmission generally covers a national territory, an extension of the mandatory collective management was thought an excessive limitation of the right holders' rights and it would interfere with the exploitation chronology (national basis).

It was concluded that *“the evolution of television services in the framework of the information society leads the Commission to reflect on the need to adapt certain current mechanisms relating to the protection copyright and related rights (settlement of disputes, role of collecting societies): the methods of managing rights to cable retransmission and mediation will thus be assessed in the general context of the evolution of the media in the information society before considering whether or not to revise Dir 93/83/EEC”*. It was thought that technological developments (digital TV and internet) would create more possibilities to offer cross-border audiovisual services and that viewers' habits would change, probably

---

413 Explanatory Memorandum, SatCab Proposal, 36.

414 Explanatory Memorandum, SatCab Proposal, 36.

415 Explanatory Memorandum, SatCab Proposal, 36.

416 Report from the Commission on the application of Council Directive 93/83/EEC on the coordination of certain rules concerning copyright and rights related to copyright applicable to satellite broadcasting and cable retransmission, COM(2002) 430 final, 26 July 2002, 5 (hereafter 2002 Commission Report). See also P.B. HUGENHOLTZ, “Copyright without Frontiers: is there a future for the Satellite and Cable Directive?”, *Die Zukunft der Fernsehrichtlinie/The Future of the ‘Television without Frontiers’ Directive*, Band 29, Nomos Verlag, Baden-Baden, 2005, accessed via [www.ivir.nl](http://www.ivir.nl); J. CORBET, “Verslag van 26 juli van de Europese Commissie (toepassing van de richtlijn van de Raad over de satellietomroep en de kabeldistributie, COM (2002) 430 def), A&M 2003/3, 198-202.

417 Critical about this conclusion: E. WERKERS, “Broadband Content Services : Intellectual Property Rights at War with Convergence?”, (August 24, 2006). Available at SSRN: <http://ssrn.com/abstract=1923695> or <http://dx.doi.org/10.2139/ssrn.1923695>.

418 “A satellite distributor, which is neither a broadcasting organisation nor a satellite operator providing transport) includes in a single package a number of channels which have already had an initial broadcasting, rents transmission bans from a satellite operator and makes that package available to television viewers against payment of a subscription”. See 2002 Commission Report, 15.

evolve towards more individualised and personalised access to services. It was considered too early to assess these changes and to consider extending the scope of the SatCab Directive.

In the following section, we will examine the elements of the definition of the cable retransmission right. We will start with some preliminary considerations (sub a)), then we will analyse the initial transmission (sub b)) and finally the retransmission by cable (sub c)). We will discuss the relevant decisions of CJEU and the few national decisions we have come across (mainly from Belgium, The Netherlands, Austria and Germany).

### a) Preliminary

The right of retransmission by cable is formulated by reference to television or radio programmes. This can be explained by its common origin with the Directive Television Without Frontiers and the pursuit of an audiovisual internal market<sup>419</sup>. The definition does not refer to “works” or subject matter protected by neighbouring rights, but to “television or radio programmes”, which may of course contain subject matter protected by copyright or neighbouring rights. However, the Directive does not explain what constitutes a “programme”<sup>420</sup>. A “programme” may refer to one delineated creation, intended for broadcasting (e.g. game show, a talk show, an episode of a television series, perhaps a broadcast film). However, a “programme” could also be understood as broadcast programming or the schedule, i.e. the whole of items selected for broadcasting in a certain chronology (linear). The term “television or radio programmes” implicitly refers to a certain practice of the “broadcasting” sector, intrinsically (though not exclusively) connected to certain technologies.

The definition of a programme has consequences for the assessment of the “unaltered” and “unabridged” character of the retransmission. The question then arises how the practice should be regarded, which consists of retransmitting a television programme for a limited period of time or offering programmes of different broadcasters on the same channel. According to DREIER, such practices may be considered cable retransmissions in the sense of the Directive, the purpose of the Directive being to facilitate the acquisition of rights in due course of time<sup>421</sup>. This does not mean of course that the cable operator can operate a selection of the best parts of different programmes under the regime reserved for cable retransmissions.

### b) Initial transmission

The Directive requires an “*initial transmission from another Member State, by wire or over the air, including that by satellite, of television or radio programmes intended for reception by the public*”.

We will examine each element of this initial transmission: (1) coming from another Member State, (2) by wire or wireless means, (3) intended for reception by the public.

**From another Member State.** The Directive only harmonises the applicable regime for transmission of programmes coming from another Member State. Purely national situations, i.e. the retransmission on the territory of one Member State of programmes initially transmitted in the same Member State, are not

---

419 Council Directive 89/552/EEC of 3 October 1989 on the coordination of certain provisions laid down by Law, Regulation or Administrative Action in Member States concerning the pursuit of television broadcasting activities, OJ L 298, 17.10.1989, p. 23–30, now Directive 2010/13/EU of the European Parliament and of the Council of 10 March 2010 on the coordination of certain provisions laid down by law, regulation or administrative action in Member States concerning the provision of audiovisual media services (Audiovisual Media Services Directive) (Text with EEA relevance), OJ L 95, 15.4.2010, p. 1–24.

420 P.B. HUGENHOLTZ, « SatCab Revisited : the past, present and Future of the Satellite and Cable Directive », IrisPlus 2009/8 (7), 13.

421 Th. DREIER, “Satellite and Cable Directive” in M. M. WALTER & S. VON LEWINSKI (ed), European Copyright Law, Oxford, University Press, 2010, 420 (hereafter, DREIER, “Satellite and Cable Directive”).



covered by the Directive. Similarly, the cable retransmissions of initial transmissions from third countries, outside the European Union, are not dealt with either.

In both cases, the Member States retain full competence to regulate national cable retransmissions of broadcasts, both taking place on the territory of one Member State<sup>422</sup>.

**By wire or over the air.** According to the definition in the SatCab Directive, the initial transmission of television or radio programmes may be carried out **by wire or over the air**, including by satellite. Unlike the Berne Convention, the cable retransmission right does not only apply to “broadcasts”, i.e. wireless communications to the public (art. 11bis(1)(ii) BC).

The Danish Copyright Act defines the initial transmission as a wireless broadcast (s. 35 Danish Copyright Act)<sup>423</sup>. It is required that there is a simultaneous wireless broadcast of the content. This does not mean that the retransmission (by cable or by wireless means) should technically be operated on the basis of this wireless broadcast signal. A cable retransmission may be found, even if the content is delivered to the cable operator by means of a wired connection. The content of the signal must be unaltered and unabridged, not the signal<sup>424</sup>. Since the Danish law restricts the retransmission right to the retransmission of initial transmission by wireless means (rather than “by wire or over the air”), FOGED observes that the Directive has not been transposed correctly<sup>425</sup>.

In France, the retransmission by cable is dealt with in art. L.132/20,1° CPI<sup>426</sup>. It is stated that the authorisation to broadcast a work by Hertzian waves does not include the transmission by cable of this broadcast, unless the transmission is executed simultaneously and integrally by the organisation which benefits from this authorisation and without extending the geographical reach covered by the contract. In other words: the broadcaster may assume that it is entitled to transmit the work by cable, integrally and simultaneously, within the reach of the broadcast – unless the contract provides otherwise. It should be remarked that this provision explicitly refers to a particular type of terrestrial broadcasts, by Hertzian waves. As far as the retransmission by cable on the French territory of a work, broadcast in another Member State, it is stated that this right may only be exercised by a collecting society (Art. L132-20-1 CPI<sup>427</sup>).

**Intended for reception by the public.** Finally the initial transmission of television or radio programmes should be intended for reception by the public.

422 Austrian Supreme Court (Oberste Gerichtshof) 21 February 2008, 4Ob89/08d, accessible via <https://www.ris.bka.gv.at>.

423 T. FOGED, “DTT primary transmission and retransmission – copyright challenges”, [http://www.ubod.dk/fileadmin/user\\_upload/ubo/articles/TF\\_article.pdf](http://www.ubod.dk/fileadmin/user_upload/ubo/articles/TF_article.pdf), 3 September 2009, p. 11.

424 T. FOGED, “DTT primary transmission and retransmission – copyright challenges”, p. 11. This appears from the explanatory note to the Danish copyright act, as quoted by this author. According to her the SatCab Directive does not require it either, nor the BC.

425 T. FOGED, “DTT primary transmission and retransmission – copyright challenges”, p. 13.

426 Sauf stipulation contraire :

1° L'autorisation de télédiffuser une œuvre par voie hertzienne ne comprend pas la distribution par câble de cette télédiffusion, à moins qu'elle ne soit faite en simultané et intégralement par l'organisme bénéficiaire de cette autorisation et sans extension de la zone géographique contractuellement prévue. (...)

4° L'autorisation de télédiffuser une œuvre par voie hertzienne comprend la distribution à des fins non commerciales de cette télédiffusion sur les réseaux internes aux immeubles ou ensembles d'immeubles collectifs à usage d'habitation installés par leurs propriétaires ou copropriétaires, ou par les mandataires de ces derniers, à seule fin de permettre le raccordement de chaque logement de ces mêmes immeubles ou ensembles d'immeubles collectifs à usage d'habitation à des dispositifs collectifs de réception des télédiffusions par voie hertzienne normalement reçues dans la zone.

427 I.-A compter de la date d'entrée en vigueur de la loi n° 97-283 du 27 mars 1997, le droit d'autoriser la retransmission par câble, simultanée, intégrale et sans changement, sur le territoire national, d'une œuvre télédiffusée à partir d'un Etat membre de la Communauté européenne ne peut être exercé que par une société de perception et de répartition des droits. Si cette société est régie par le titre II du livre III, elle doit être agréée à cet effet par le ministre chargé de la culture.

An important question is whether a transmission by cable to the public, following a transmission between the “broadcaster” and the cable operator, should be qualified as a “retransmission by cable” in the sense of the SatCab Directive. Before examining the national decisions on this issue, we will examine the decisions of the CJEU in *Lagardère* and *Mediakabel*. These decisions do not relate to cable retransmissions as such, but they are often referred to by courts dealing with the cable retransmission right. It seems relevant to summarise the ruling in these decisions and to elaborate on the notion of the “public”, which has proven quite important in the case law of the CJEU.

**CJEU.** The CJEU has interpreted the notion of the “public” in *Lagardère*<sup>428</sup>.

The facts of this case may be summarised as follows. *Lagardère* was a broadcasting company, established in France. Its programmes were transmitted to a satellite and went back to earth, where they were received by repeater stations in France, which broadcast the programmes to the public (FM), and by a transmitter in Germany, from where CERT (a *Lagardère* subsidiary) broadcasts the programmes to France on the long wave. The French language programmes could be received on a part of the German territory (the border area), but were not exploited in Germany. In parallel, *Lagardère* had a digital audio terrestrial circuit, through which the signals could be sent from the Paris studio to the transmitter in Germany (in case the satellite did not function). *Lagardère* paid royalty fees to performers and phonogram producers for the use of phonograms in its broadcasts in France (to collecting society SPRE) and a flat rate fee to GVL in Germany (which it deducted from the French remuneration). In this case the transmission scheme consisted of a first transmission (by satellite) between the studio in Paris and the transmitters in France and Germany and, from there on, a wireless broadcast (FM or AM) to the general public.

The issue was whether the first transmission by satellite (between the studio and the transmitters) should be considered an act of communication to the public by satellite (art. 1(2)a SatCab Dir). If this were the case, then the satellite broadcast could be situated in France alone and only the French copyright legislation be taken into account.

The Court of Justice decided that the initial transmission could not be seen as a satellite broadcast. The Court found that this signal was not intended for reception by the “public”. The mere fact that the signal was transmitted on non-public frequency band did not *per se* exclude that was a broadcast. *In casu* it was found that the satellite signal could only be received by professional equipment, which was not available to the general public. Applying the criterion from *Mediakabel* (*infra*), the Court found no “public”, since a public must be made up of an indeterminate number of potential listeners (*Lagardère* par. 31 – cf. *Mediakabel*, par. 30). Moreover, in relation to satellite broadcasting, the Court stated that the signals should be intended for the public and that it does not suffice that the programmes (carried by the signals) are meant for the public (*Lagardère* par; 35).

In *Mediakabel*, the CJEU has indeed come up with a definition of what constitutes a “public”, albeit in the context of the definition of a “broadcasting service” according to the Television without Frontiers Directive (art. 1(a) Directive 89/552)<sup>429</sup>.

In this case, the qualification of a service named “Filmtime” was at stake. *Mediakabel*, a Dutch operator, offered a broadcasting service (“Mr Zap”) to its subscribers, via broadcasting systems operated by third parties, and in return for a fee. Additionally, the subscribers could order films via the pay-per-view service “Filmtime”. The issue was whether this additional service should be qualified as a broadcasting service or as an interactive service of the information society. If it were a broadcasting service, then *Mediakabel* had to comply with all obligations, including acquiring the authorisation of a governmental agent and *inter*

---

428 CJEU 14 July 2005, Case C-192/04, *Lagardère Active Broadcast v Société pour la perception de la rémunération équitable* (SPRE) and *Gesellschaft zur Verwertung von Leistungsschutzrechten mbH* (GVL), Reports of Cases 2005 I-07199 (*Lagardère*).

429 CJEU 2 June 2005, Case C-89/04, *Mediakabel BV v Commissariaat voor de Media*, Reports of Cases 2005 I-04891 (*Mediakabel*).

*alia* broadcasting a certain quota of European programmes. Interactive services of the information society by contrast were not subject to these obligations.

The CJEU decided that the service was a broadcasting service, which according to art. 1(a) Dir 89/552, consists of the initial transmission of television programmes intended for reception by the public. The Court stated that a broadcasting service “*must consist of the transmission of television programmes intended for reception by the public, that is, an indeterminate number of potential television viewers, to whom the same images are transmitted simultaneously*” (Mediakabel, par. 30). In this case, the service was distinguished from an interactive service by the fact that the programme is not transmitted “on individual demand”: the pay-per-view service subscribers had access to programmes selected by the broadcaster and at times set by the broadcaster.

According to Dreier, this means *a contrario* that the making available on demand of content is not an initial transmission in the sense of the SatCab Directive<sup>430</sup>.

**Member States.** A number of decisions in the Netherlands and Belgium, have addressed the question whether a transmission of television programmes to the public by cable should be qualified as a retransmission by cable if it is preceded by a point to point transmission between the “broadcaster” and the cable operator.

The Dutch courts have come to a uniform case law on this point: a cable retransmission can be found if it is preceded by a communication to the public, i.e. the general public. In Belgian copyright law, this issue remains controversial.

**The Netherlands.** The Dutch Supreme Court was asked to rule in a conflict between collecting societies Buma and Stemra and cable operator UPC, later ChelloMedia. The facts can be summarised as follows. UPC produced television programmes and exploited some theme channels. In order to send the television programmes to the public, it had set up a technical scheme in which UPC sent encrypted programme signals to the distribution satellite Telstar 12 (uplink). From there on, the encrypted signals were sent to a cable headend (downlink). The cable distributors had the means to decode the signal and to distribute a (newly encoded) programme signal to the cable subscribers. At the same time, the encrypted programme signals were sent, from the Telstar 21 satellite, to the “Direct to Home” platforms (downlink), which sent a re-encoded signal by satellite to the “DTH” subscribers.

It was agreed that the cable operators and the DTH platform operators performed acts of communications to the public (“openbaarmaking”) by sending the programme signals to their subscribers and the remuneration they paid for these communications were not questioned. The issue here was whether the transmission by UPC to the cable distributors and to the DTH platform operators should be qualified as a communication to the public (“openbaarmaking”)<sup>431</sup>. In order to solve this issue, the question was whether the addressees of the signals should be considered a “public”.

The Dutch Copyright Act of 1912 provides in its art. 12(1) that the act of communication to the public (“openbaarmaking”) covers (*inter alia*) the broadcast of a work included in a television programme by means of satellite<sup>432</sup>. It is stated in art. 12(7) that the “*broadcast of a work included in a radio or television*

---

430 Th. DREIER, “Satellite and Cable Directive” in M. M. WALTER & S. VON LEWINSKI (ed), European Copyright Law, Oxford, University Press, 2010, 419.

431 It was accepted that the last transmission was an act of communication to the public and the rights for this transmission were cleared for a fee. It was not under consideration whether this communication to the public was a cable retransmission. Instead, the issue was whether the preceding transmission was an act of communication to the public, for which another remuneration had to be paid. This decision is however important, since the transmission scheme is similar to schemes in other cases where the cable retransmission right was at stake and because other courts have used this case as a relevant precedent, both in The Netherlands and in Belgium.

432 Art. 12(1)(5°) : « Onder de openbaarmaking van een werk van letterkunde, wetenschap of kunst wordt mede verstaan: (...)het uitzenden van een in een radio- of televisieprogramma opgenomen werk door middel van een satelliet of een andere zender of een omroepnetwerk als bedoeld in artikel 1.1 van de Mediawet 2008”.

*programme by means of a satellite should be understood as the “act of introducing, under the control and responsibility of the broadcasting organization, the programme-carrying signals intended for reception by the public into an uninterrupted chain of communication leading to the satellite and down towards the earth. If the programme-carrying signals are encrypted, then there is broadcast of a work included in a radio or television programme by means of satellite, if the means for decrypting the broadcast are provided to the public by the broadcasting organization or with its consent”<sup>433</sup>. This provision is the implementation of art. 1(2) of the SatCab Directive.*

The Court of first instance of Amsterdam decided in 2005 (some months before *Lagardère*) that the transmission by satellite to the cable distributors and the DTH platform operators should not be considered a communication to the public<sup>434</sup>. The court came to the conclusion that there was no protected communication, since the signals, transmitted by UPC, are meant for the cable operators and the DTH platform operators, but not for the general “public”. The Court referred to the SatCab Directive (rec. 17, 6) and to the Television without Frontiers Directive (rec. 4, 5). The judge considered that the encrypted signal was transmitted to the satellite only to be received later on by the cable operators and the DTH platform operators (which were bound by contract), the only ones having the technical means to use these signals. Moreover, the cable operators and DTH platforms only decrypted these signals in order to transmit the (re-encrypted) signals to the public (which had the means to decrypt them), a transmission that was indeed considered a communication to the public for which a remuneration is due.

The Court of appeal of Amsterdam confirmed this decision in 2006<sup>435</sup>. It referred to the CJEU’s interpretation of “public” in *Mediakabel* and *Lagardère*<sup>436</sup>. In these decisions, a “public” was found when a broadcast of television programmes was addressed to an indeterminate number of potential listeners or viewers. The Court considered that a select circle of operators of cable headends or DTH platforms was not a public. Moreover, the transmission by UPC (Chello) could not be qualified as a communication to the public by satellite on account of the later transmission (via the cable operators resp. DTH satellite) to the public. No communication to the public by satellite was found since the public was not reached in an uninterrupted chain, but in two phases instead.

The Dutch Supreme Court (Hoge Raad) confirmed this decision of the Court of Appeal in its decision of 2009<sup>437</sup>. The Court ruled that “public” should be interpreted in conformity with the interpretation given by the CJEU in *SGAE/Rafael Hoteles* (C-306/05) and in *Lagardère*, in the sense that a public consists of an indeterminate number of potential viewers. According to this Supreme Court, the notion of “public” is the same in the directives SatCab (*Lagardère*) and InfoSoc (*SGAE*). The Court of appeal came to the right decision, that a transmission to the cable operators and the DTH platform operators did not reach a “public” and that the *signals* should be meant for the public (not the programmes) in order to find a distinct act of communication to the public.

Another Dutch case was brought by the collecting society NORMA, representing performers and artists, in a case against a number of cable operators and their collective organisation. The cable operators

---

433 This is a non-literal translation: “7. Onder het uitzenden van een in een radio- of televisieprogramma opgenomen werk door middel van een satelliet wordt verstaan de handeling waarbij de programmadragende signalen voor ontvangst door het publiek onder controle en verantwoordelijkheid van de omroeporganisatie worden ingevoerd in een ononderbroken mededelingenketen die naar de satelliet en terug naar de aarde voert. Indien de programmadragende signalen in gecodeerde vorm worden uitgezonden, is er sprake van het uitzenden van een in een radio- of televisieprogramma opgenomen werk door middel van een satelliet, indien de middelen voor het decoderen van de uitzending door of met toestemming van de omroeporganisatie ter beschikking van het publiek worden gesteld”.

434 Court Amsterdam 12 January 2005, AMI 2005, 135-139, *Buma/Stemra v UPC*.

435 Court of Appeal Amsterdam 29 June 2006, AMI 2007/1, 11, *Buma/Stemra v Chellomedia* (previously UPC).

436 CJEU 2 June 2005, Case C-89/04, *Mediakabel BV v Commissariaat voor de Media*, Reports of Cases 2005 I-04891, “*Mediakabel*”; CJEU 14 July 2005, case C-192/04, *Lagardère Active Broadcast v Société pour la perception de la rémunération équitable (SPRE)* and *Gesellschaft zur Verwertung von Leistungsschutzrechten mbH (GVL)*, Reports of Cases 2005 I-07199, “*Lagardère*”.

437 Hoge Raad 19 June 2009, LJN BH7602, 07/12553, *Vereniging Buma v Chellomedia Programming*, [www.rechtspraak.nl](http://www.rechtspraak.nl) consulted on 14 February 2013.

distributed television programmes to their subscribers. In order to do so, the broadcasters (which held the rights to the primary broadcasts) made the broadcast signals accessible to the cable operators via a dedicated platform named “Media Gateway”. This platform was not accessible to the general public.

The issue here was whether the competence of the collecting societies extended to *all* communications to the public, including the first communication to the public of a signal. The collecting society NORMA claimed a remuneration for the retransmission by cable in favour of the holders of related rights. It acted both for affiliated and non-affiliated right holders, based on the provisions on the mandatory collective management of these rights.

The Dutch Act on Neighbouring Rights provides a mandatory collective management of the rights of performing artists and phonogram producers to authorise the unaltered and unabridged re-broadcast of a performance or phonogram via a network as described in another act (media law)<sup>438</sup>. A re-broadcast is defined as the simultaneous broadcast (“uitzending”) by one institution of a programme that is broadcast by another institution or broadcasting organisation (art. 1(h) Dutch Act on Neighbouring Rights<sup>439</sup>).

The first court decided that the cable transmission to the subscribers is not a re-broadcast in the sense of the act on neighbouring rights<sup>440</sup>. The collecting society’s intervention for the management of the rights is mandatory for secondary communications but not primary cable transmissions. The Court of first instance of The Hague decided that the direct transmission by the broadcaster to the cable operator (either by satellite or by wire but in neither case accessible to the public) was not a broadcast by the broadcasting organisation. By consequence, the subsequent distribution of the programmes by the cable operator should not be considered a re-broadcast but a “broadcast”. There was no simultaneous broadcast. The Court referred to the wording of the act, to the explanatory memorandum at the occasion of the implementation of the SatCab Directive. Since the Dutch act does not impose any mandatory collective management in case of *primary* transmissions by cable, the claim was rejected.

The Court of appeal confirmed this decision<sup>441</sup>. After a summary of the history of cable retransmissions in The Netherlands and a comparison to the current situation, it observed that the general public has no way of accessing the programmes while these are being transmitted from the broadcasters to the cable operators: the Cable operators do not work on the basis of broadcast signals anymore and the “Media Gateway” platform, where the cable operator retrieved the signal from the broadcaster, was not accessible to the general public. The Court here referred to the CJEU decisions in *SGAE* (C-306/05), *Lagardère* (C-192/04) and its interpretation of what constitutes a “public” (an indeterminate number of potential viewers or listeners) and to the Dutch Supreme Court decision in *Buma/Chellomedia*. It went as far as to state that the notion of “public” in *Lagardère* was the guiding principle for the “communication to the public” in the Dutch Copyright Act and that the same notion should apply when exercising neighbouring rights (harmonised under the Rental Rights Directive and thus inscribing in the same legal context).

The Court then considered NORMA’s argument that “re-broadcasting” (*heruitzending*) covered both primary and secondary communications to the public, to the effect that a communication to the public that is *not* preceded by another communication to the public should also be qualified as a “re-broadcast”. The Court rejected NORMA’s reasoning, based on an examination of the Dutch legislation and the SatCab Directive. The Court noticed that the English version of the SatCab Directive refers to the “initial

---

438 Wet van 18 maart 1993, houdende regelen inzake de bescherming van uitvoerende kunstenaars, producenten van fonogrammen of van eerste vastleggingen van films en omroeporganisaties en wijziging van de Auteurswet 1912, via <http://wetten.overheid.nl/BWBR0005921/>, art. 14a Dutch Act on Neighbouring Rights.

439 Art. 1(h) WNR: “heruitzenden: het door een instelling gelijktijdig uitzenden van een programma dat door een andere instelling of omroeporganisatie wordt uitgezonden”.

440 Rb. Den Haag 28 January 2009, case nr. 271796 / HA ZA 06-2844, NORMA v Vereniging NLKabel, IEPT 20090128, [www.ieportal.nl](http://www.ieportal.nl).

441 Gerechtshof ‘s Gravenhage 10 April 2012, case nr 200.036.425/01, NORMA v Vereniging NLKabel e.a., IER 2012, 38, [www.rechtspraak.nl](http://www.rechtspraak.nl);

transmission” and “retransmission”, both considered forms of communication to the public (rec. 23 InfoSoc Dir). The Court derived from this observation that both the retransmission by cable and the first transmission (or broadcast) should be “communications to the public”. The retransmission by cable in the Directive is a secondary communication to the public and “heruitzending” in the Dutch act should be understood in the same way. The cable operators perform a primary act of communication to the public, which, inversely, is not an act of re-broadcasting (*heruitzending*).

*Ad abundantiam* the Courts considered the consequences of NORMA’s proposed interpretation. If a primary communication to the public by cable were qualified as a cable *retransmission*, then it would be subject to mandatory collective management. This would mean that individual right holders had no legal means of opposing such exploitation (since the right would be exercised by collecting societies alone). Moreover, the mandate of the collecting societies extends to right holders who are not affiliated to a collecting society (“outsiders”), so these right holders would have no say in the primary exploitation of the work. The Court’s understanding of a “retransmission by cable” would not lead to such far-reaching consequences: if the primary communication to the public is subject to the individual author’s authorisation, then she can exercise at least some control over the secondary communication to the public as well<sup>442443</sup>.

NORMA has appealed this decision to the Supreme Court (Hoge Raad), which is expected to give judgement before the end of 2013.

**Belgium.** The decisions in Belgium qualify the transmission by cable following a “direct injection” in a less consistent way.

The Belgian Copyright Act contains a definition of the right of retransmission by cable in its art. 52, which is nearly identical to the definition in the SatCab Directive. The Dutch and French versions of the text are slightly differently worded, as is the case for the Dutch and French versions of the cable retransmission right in the SatCab Directive. According to the Dutch version, a “*transmission by cable*”<sup>444</sup> should be understood as the “*simultaneous, unaltered and integral transmission, by means of a cable or microwave system, to the public of a first broadcast, by air or not, also by satellite, of television or radio programmes that are meant for reception by the public*”<sup>445</sup>. The French version by contrast defines the retransmission by cable as “*the simultaneous, unaltered and integral retransmission, by cable or by a microwave system, for reception by the public, of an initial transmission, by wireless means or by wire in particular by satellite, of a television or radio programmes intended for reception by the public*”<sup>446</sup>.

The legal obligation for cable distributors to acquire the right holders’ consent for a distinct act of communication to the public was established, after long judicial battles, in the 1980s<sup>447</sup>. A general contract concerning the retransmission by cable was concluded in 1983, between the cable operators and the right holders (collecting societies for authors and film producers and broadcasting organisations).

442 It may be pointed out that the performers’ rights are already restricted by the Rental and Lending Rights Directive (2006/115). According to art. 8 of the Directive, performers have an exclusive right to the wireless broadcasting and the communication to the public of their performances, except where the performance is itself already a broadcast performance or is made from a fixation. The broadcasting of the communication to the public on the basis of a phonogram, published for commercial purposes or its reproduction, gives rise to an equitable remuneration.

443 However, if a work has been broadcasted in the context of a primary communication to the public without the authorization of the right holder, the secondary communication may nevertheless be lawful if it has been allowed by the collecting society holding the rights for such communication to the public,

444 The Dutch text literally refers to a « transmission » rather than a « retransmission ».

445 « Onder doorgifte via de kabel wordt verstaan de gelijktijdige, ongewijzigde en integrale doorgifte, door middel van een kabel- of microgolfsysteem, aan het publiek, van een eerste uitzending, al dan niet via de ether, ook per satelliet, van televisie- of radioprogramma’s die voor ontvangst door het publiek bestemd zijn”.

446 “La retransmission par câble s’entend de la retransmission simultanée, inchangée et intégrale par câble ou par un système de diffusion par ondes ultracourtes pour la réception par le public d’une transmission initiale, sans fil ou avec fil, notamment par satellite, d’émissions de télévision ou de radio destinées à être captées par le public.”

447 M. GHYS, « C’était un soir, messieurs, mesdames,... mais la télé n’a jamais été en panne... », A&M 2006, 221-231.

Several (provisional) contracts have governed the issue until the mid 1990s, when several legal actions were taken between the different interested parties because of the termination of these contracts.

In 1998 the Brussels Court of appeal issued a decision on the question of the initial transmission, preceding a cable transmission to the public<sup>448</sup>. Uradex, the collecting society of the performing artists, claimed remuneration for the retransmission by cable of the performances of the affiliated and non-affiliated performers, based on the right of retransmission by cable, as harmonised by the SatCab Directive.

Many issues were dealt with in this decision<sup>449</sup>, among which the transmission by cable of radio programmes. As far as a cable distribution following a “direct injection” was concerned, the Court considered this a retransmission by cable to the public. A “direct injection” was defined as the distribution by cable of programmes, which are transmitted by the broadcaster to the cable operator by means of a dedicated line, in order to be then retransmitted to the public by means of the cable<sup>450</sup>. Such direct injection could also be a retransmission by cable, based on the following considerations. 1) The Court found two transmissions: an initial transmission between the broadcaster and the cable operator and a retransmission to the public via the cable network. It was not considered relevant that the initial transmission was operated via a direct line (by telephone or otherwise), since the law includes initial transmissions by wire or wireless means and, *in casu*, it was meant for reception by the public. 2) The first transmission was captured or received by the cable operator, before being retransmitted. The conclusion was that there was no substantial difference between a retransmission following a direct injection or following a broadcast of the programme, since in both cases there was a new communication to the public by a different organisation than the broadcaster, i.e. the cable operator (art. 11bis, §1, 2° BC).

The Brussels Court of first instance deviated from this decision of the court of appeal in 2005, in a case opposing a broadcasting organisation (RTBF) and a number of cable distributors<sup>451</sup>.

Following the termination of the global contracts with all parties concerned with cable transmission, the broadcasting organisation RTBF had entered a pre-agreement with the trade organisation of cable distributors, but a dispute concerning the scope of this agreement led to this conflict regarding the cable transmissions after 1 July 1996.

One of the issues was whether there was an act of retransmission by cable, in the sense of the Belgian Copyright Act, when the programmes were transmitted from the broadcasters to the cable operators by “direct injection” and the cable operators subsequently transmitted the programmes directly to their subscribers, without a primary broadcast (by wireless means).

The Court of first instance decided that this was not the case: a cable transmission following a direct injection constituted one single transmission to the public by cable, not a cable retransmission. Moreover, this Court of first instance explicitly discarded the earlier decision of the Brussels Court of appeal, dating

---

448 Bruxelles 25 June 1998, AM 1999, 212.

449 Other issues were *inter alia* the quality of the collecting society to act on behalf of performers involved in an audiovisual production. These points of law gave rise to the decision of the CJEU in Uradex (*supra*, case C-306/05). The Court of appeal also decided that a transmission by cable could not be a “broadcast”, which could only be done by wireless means. The qualification as a “broadcast” would have restricted the exclusive right of the performer, with respect to performances that were legitimately reproduced or broadcast (art. 41 Belgian Copyright Act). The Court refused this qualification however, defining a “broadcast” by reference to art. 11bis BC as “any form of radio or television broadcast and any public communication by any other means serving to distribute by wireless means signs, sounds and images” (« la radiodiffusion doit être définie comme étant toute forme de radio et de télédiffusion ainsi que « la communication publique par tout autre moyen servant à diffuser sans fil les signes, les sons et les images »).

450 « Attendu qu’il y a lieu d’entendre par « injection directe », la diffusion de programmes qui sont transmis par le radiodiffuseur au câblodistributeur au moyen d’une ligne propre pour être ensuite retransmise au public par la voie du câble ».

451 Civ. Bruxelles 27 January 2005, RTBF v Société Intercommunale Namuroise de Télédistribution e.a., A&M 2005/2, 138.

back to 1998<sup>452</sup>. The Court went on to establish that the cable operator should be held responsible for the communication to the public by cable, rather than the broadcaster. It was considered that the cable operator owned the cable network, received a price for the distribution of the programmes to the cable subscribers (whether or not the programmes are first broadcast by terrestrial means) and thus made a profit from the communication to the public. The broadcaster's role by contrast was considered restricted to the provision of technical means to perform the direct transmission via cable in the form of a connection or an encrypted broadcast.

The issue of the cable transmission following a direct injection was raised again in case involving the cable distributor Telenet<sup>453</sup>.

Telenet is a Belgian cable operator and a mobile, internet and telephone provider, which offered television services to its subscribers via its cable network. It transmitted the programmes via analogue and digital signals. The "traditional" cable services (where a primary broadcast precedes the cable transmission) were covered by a contract, concluded by the trade organisation of the cable operators (RTD). Where the programmes were directly injected in the cable network (commercial programmes), Telenet had no agreement with the collecting societies, but with the broadcasting organisations, which supposedly had acquired all the exploitation rights including the cable transmission rights ("all rights included" contracts). Telenet initiated a legal action against several collecting societies, in view of obtaining a statement that the cable transmissions it performed ("Telenet Digitale Televisie") did not require the right holders' distinct consent.

One of the issues was whether the "direct injection" should be considered a protected act. The question was in particular if a direct injection of a programme and the subsequent cable transmission to the public should be considered as one unique protected act (primary broadcast via cable) or as two acts, which should both be authorised and remunerated.

The Court of first instance of Mechelen decided in favour of Telenet<sup>454</sup>. It considered that a cable transmission to the public subsequent to a direct injection in the cable of television programmes cannot be qualified as a cable retransmission in the sense of the Belgian copyright act and the SatCab Directive. Such transmission via cable should be considered a primary cable transmission. The Court established that there was no broadcast via the air (terrestrial) or via satellite, there were no signals broadcast for reception by the public which are received and then retransmitted. Instead there was a transmission to the cable distributors alone, the signal not being accessible to the public. The first court adopted the definition of the "public" that the CJEU put forward in *Lagardère*, i.e. an indeterminate number of potential viewers or listeners. A limited circle of people who can receive the signals by professional technical equipment (i.e. the cable operators *in casu*) is not a public, hence the criterion of art. 1.2a SatCab Dir was not met. The circumstance that ultimately the programmes were meant for the public did not alter this conclusion. The court also established that there was no restricted act in the sense of art. 11bis.1.2 BC, but instead a primary communication to the public in the sense of art. 11(1) BC. For the Court, it was decisive that the public does not receive two distinct communications. Since the cable transmission following a direct injection is considered a primary communication to the public by cable, the collective management of rights was not mandatory. Finally, the Court found that the responsibility for acquiring the authorisation rests upon the broadcasting organisations. The mere provision of physical facilities for enabling or making a communication (i.e. cable network) does not in itself amount to communication. The Court was satisfied with Telenet's allegation that it had concluded "all rights included" contracts with the broadcasting organisations, without requiring access to such contract (although their existence was contested by the collecting societies).

---

452 Bruxelles 25 juin 1998 AM 1999, 212, *supra*.

453 Rb. Mechelen 12 April 2011, I.R. D.I. 2011, 238, « Telenet »; Antwerpen 4 February 2013, 2011/AR/1523, 2011/AR/2545, 2011/AR/2546, 2011/AR/2578, 2011/AR/2582, SABAM e.a. c Telenet, unpublished

454 Rb. Mechelen 12 April 2011, I.R. D.I. 2011, 238, « Telenet ».



The Court of appeal of Antwerpen issued an interim decision in 2013<sup>455</sup>. On the issue of the cable retransmission, the decision is not straightforward and difficult to understand. The Court of appeal first observed that the cable transmission to the public following a direct injection (of the programmes by the broadcaster into the cable network) should be seen as one unique act of “broadcasting via the cable network”. Yet later in the decision, it found that Telenet’s operations should be seen as cable retransmissions.

The Court of appeal started by stating that a cable transmission following a direct injection is not a retransmission by cable, since there is no primary broadcast to the public. There was only one transmission by cable, which is assimilated to a primary broadcast. It confirmed the standard of the “public” of *Lagardère* and it referred to the decision of the court of appeal of The Hague of 10 April 2012 (*supra*). It found confirmation of its decision that there is only one act of communication to the public, by reference to art. 11 and 11bis BC, which require two distinct acts of communication to the public. Finally, the Court of appeal distinguished the circumstances of the Telenet case from those that gave rise to *Airfield*<sup>456</sup>, in the sense that Telenet does not reach a new public (since the signal transmitted by the broadcaster to the cable operator is not meant for the public). So far the decision was quite straightforward.

However, while deciding on the responsibility for the communication to the public by cable, the Court seemed to reach the opposite conclusion. Unlike the first judge, the Court of appeal decided that Telenet (rather than the broadcasters) had the responsibility of acquiring the right holders’ consent for the cable transmission. Telenet’s role was not restricted to the provision of physical installations for the transmission of signals, instead it offers different “packs” of programmes. Quoting the rights of reproduction, adaptation, communication to the public and distribution and the right to cable retransmission, the Court found that Telenet, in case of direct injection, operated a “*simultaneous, unaltered and integral transmission, by cable, to the public, of a first broadcast of a television programme, which is meant for reception by the public*”<sup>457</sup>. The Court of appeal concluded that the direct injection is a cable transmission, for which the right holders’ consent is required. It thus rejected Telenet’s position that the direct injection of a programme is not a cable retransmission in the sense of art. 52 BCA and constitutes one single act with copyright relevance (communication to the public in the sense of art. 1 BCA, art. 11.1 BC or art. 3 InfoSoc Dir). The Court seemed to see no contradiction in finding on the one hand, a primary act of communication to the public by cable and, on the other hand, a (re)transmission by cable to the public, to which the mandatory collective management is applicable.

It was then argued that, even if a cable retransmission was found, the broadcasters could grant the rights in “all rights included contracts”, which Telenet claimed to have concluded. The Court disagreed: the broadcasters could only grant a licence for the retransmission via cable for their own programmes, not for the ones they have bought<sup>458</sup>. By consequence, the collecting societies could exercise the exclusive rights of cable transmission – except for the broadcasters’ own productions. The case was adjourned to give the parties the opportunity to defend their positions on the exact scope of the use and who holds which rights (broadcasters, producers, collecting societies).

---

455 Court of appeal Antwerpen 4 February 2013, 2011/AR/1523, 2011/AR/2545, 2011/AR/2546, 2011/AR/2578, 2011/AR/2582, SABAM e.a. c Telenet, unpublished.

456 CJEU 13 October 2011, Joined cases C-431/09 and C-432/09, *Airfield NV and Canal Digitaal BV v Belgische Vereniging van Auteurs, Componisten en Uitgevers CVBA (Sabam) (C-431/09)* and *Airfield NV v Agicoa Belgium BVBA (C-432/09)*.

457 It should be noted however, that in the Dutch version of the Belgian Copyright Act, the right of retransmission by cable is worded as « transmission » by cable (kabeldoorgifte). The French version uses the term « retransmission », which implicitly refers to a secondary transmission (« retransmission par câble »). This connotation is lacking in the Dutch wording.

458 The Belgian Copyright Act (art. 53, §3) provides that the broadcaster can exercise its right in relation to its own” broadcasts” (“haar eigen uitzendingen” or “à l’égard de ses propres émissions”). By contrast, the SatCab Directive provides that “Member States shall ensure that Article 9 does not apply to the rights exercised by a broadcasting organization in respect of its own transmission, irrespective of whether the rights concerned are its own or have been transferred to it by other copyright owners and/or holders of related rights” (our emphasis).

The same question of the qualification of a cable transmission following a direct injection was posed to the Court of first instance of Brussels, which was seized to rule in a litigation between three collecting societies (SACD, SCAM and SOFAM) and a cable operator Coditel<sup>459</sup>.

The Court considered the arguments but postponed its decision. The Court depicted the technical background of the cable retransmission and described how, at first, the broadcast signals were captured by the cable operators, via their cable head-ends, and injected into the cable network so they could be retransmitted to the cable subscribers. It was observed however that several broadcasters no longer broadcast their television programmes and that they use the technique of “direct injection” to transmit the programmes by wire or by satellite (encrypted) to cable distributors, which then distribute the programmes via the cable network.

The Court considered that the direct injection should not be qualified as an act of broadcasting, but rather as a private communication. Technically there is no longer a retransmission of a primary broadcast. The Court referred to the decisions of the Hoge Raad (the Netherlands) in *Chellomedia*, the Court of appeal of The Hague (*Norma*); the Court of first instance of Brussels in 2005 and the Court of first instance of Mechelen (*Telenet*), concluding that there was no retransmission by cable. On the other hand, it was considered that other courts have come to a different conclusion (Court of appeal of Brussels 1998).

After having carefully set out the arguments in support of the qualification, on the one hand, as a unique communication to the public by cable or, on the other hand, a retransmission by cable, the Court decided to ask a preliminary question to the CJEU<sup>460</sup>.

**Other Member States.** In Hungary, an expert opinion was delivered in 2000 in the framework of a litigation between cable operators and a collecting society, after the new Hungarian Copyright Act (HCA) became effective in 1999<sup>461</sup> (but before the adoption of the InfoSoc Directive). The Expert Board was asked to express its opinion on the question whether broadcasting encoded signals results in simultaneous, unaltered and unabridged retransmission by cable companies under the HCA. The applicant was looking for guidance on whether the technical contribution of (usually) cable companies to decode the encoded programming is a separate use [cable retransmission under Art. 28(2) HCA] or an integral part of broadcasting by television and/or radio organisations [under Art. 26(3) HCA]. The expert body held the opinion that the encoded broadcast should be considered as a part of the broadcast (art. 26 HCA). Companies that provide decoders to end-users contribute to the broadcasting in a merely technical sense (even though they are sometimes cable operators) and the broadcaster initiates and controls the original data transfer. Decoding and the transfer of decoded signals is seen as an integral part of the process (broadcasting) rather than as independent uses. Consequently such transmissions are considered neither independent broadcasting, nor cable retransmission. This reading finds support in the text of the statute, according to which the cable company shall provide access to the decoded signals only under a written contract concluded between the cable company and the radio/television organization. This means that, in Hungary, cable companies are seen as only “contributing” to the radio/television organizations’ broadcasting activity.

In Italy, cable retransmission is defined as the simultaneous (unabridged and integral) re-transmission, through a system of cable redistribution or through very high frequencies, addressed to the public, of a primary radio- or TV broadcasting emission, irrespectively of the modes of its diffusion, coming from another Member State and designed to be received by the public (art. 16-bis, c), Italian Copyright Act). This provision refers exclusively to the cable retransmission right (as specifically defined under art. 16-bis, c)). The case law has not clarified the exact meaning and scope of the retransmission right, in particular with regard to emissions coming from broadcasters that are addressed to a cable operator, without being

---

459 Trib. comm.Bruxelles 29 January 2013, RG nr. 5865/11, Société des Auteurs et Compositeurs Dramatiques (SACD), Société Civile des Auteurs Multimédia (SCAM), Société Multimédia des Auteurs des arts Visuels (SOFAM) c Coditel, unpublished.

460 The case was adjourned to allow the parties to take positions on the wording of the preliminary questions.

461 This case was settled and the agreement between the cable operators and the collecting society was confirmed by the court.

directly delivered to the public (with the cable operator merely capturing the transmission signal and re-transmitting it into a different country). The definition provided by Italian law is particularly narrow, and it does not allow cable operators to take advantage of the regime of mandatory collective management for broadcasts that they retransmit while having received them directly from broadcasters (i.e., to do so cable operators will have to clear the right of communication to the public in the standard way)

Finally, according to national experts, in France and in Denmark, the “initial transmission” needs to be an act of communication to the public in its own right.

**Comments.** With regard to the initial transmission, it is noted that the main uncertainty relates to the direct injection of television or radio programmes in the cable network, operated by the “broadcaster” and the cable operator. In the discussed cases, the qualification of this initial transmission is approached from different angles.

In some cases, the cable transmission to the public was not the subject matter of the discussion and the parties agreed that this constituted a protected act for which the right holders’ consent was required and a remuneration was due. The legal issue was instead whether the initial transmission was an independent act of communication to the public, in addition to the subsequent communication to the public by cable, for which a distinct fee could be claimed (cf. *Buma-Stemra/UPC-ChelloMedia*).

In other cases, the purpose was not only to establish the existence of two distinct acts of communication to the public, but also to qualify both transmissions and specifically to find a “retransmission by cable”. This qualification indeed allows collecting societies to establish the mandatory character of the collective management of the rights at stake or to represent non-affiliated right holders of the same category of rights they generally manage (NORMA, Uradex, Telenet).

It may be noted that the criterion frequently applied to qualify the first transmission was the notion of “public” in *Lagardère*<sup>462</sup>. This may seem surprising, since the legal issue in *Lagardère* was whether a transmission by satellite, preceding a (wireless) broadcast of television programmes, should be qualified as an act of satellite broadcasting. The retransmission by cable was not treated or even mentioned, yet the notion of “public” applied in those particular circumstances was taken over in several other cases, relating to retransmissions by cable. Moreover, this criterion stems from the *Mediakabel* case, which did not even solve any copyright issues.

However, the CJEU in *Lagardère* distinguished between communications which could be received by the general public and transmissions that were *de facto* only accessible to a limited group of professionals (in possession of professional reception equipment). This distinction can be recognised, *mutatis mutandis*, in the communication scheme of cable transmissions following a direct injection. It is not relevant whether the “technical” transmission is operated by means of a satellite (*Lagardère*) or by cable (direct injection).

Moreover, the CJEU has generalised the definition of the “public” in *Lagardère*, by applying it as well in the context of the right of communication to the public, as harmonised in the InfoSoc Directive (see *SGAE*, par. 37<sup>463</sup>). This extension is reflected by some national courts, which include a reference to *SGAE* in their decisions<sup>464</sup>.

---

462 In favour of this reasoning : D. VISSER, « Primair openbaar maken via de kabel », AMI 2007/2 (37) 40.

463 CJEU 7 December 2006, case nr. C-306/05, *Sociedad General de Autores y Editores de España (SGAE) v Rafael Hoteles SA*, Reports of Cases 2006 I-11519, “SGAE”.

464 In favour of applying this unique definition of the « public » to the primary transmission: A. MAQUA & F. VANBOSSELE, « De Coditel à Telenet. Le nouveau périmètre de la « communication au public » des programmes de télévision linéaires », RDTI 2011/3, 5-25. More critical: E. TRAPLE, « TV signal delivery to cable operators and DTH platform operators », Jipitec 2011 (75) 82.

By contrast, the judges pay unequal attention to identifying the acts of exploitation and determining whether a communication constitutes an act of “primary” or “secondary” exploitation<sup>465</sup>.

**About the relation between a “broadcast” and a “retransmission.** Based on the explanatory memorandum to the SatCab Directive, the question may be asked how the initial transmission and the retransmission should relate to one another. It was stated in the Explanatory Memorandum that “*however, there is no cable retransmission in the sense of this proposal, if the programme is merely delivered by point-to-point communication to the cable head end without being the subject of a simultaneous primary broadcast*”<sup>466</sup>.

It could be defended that a strictly technical relation should exist and a retransmission by cable can only be found in case the signal of the initial transmission is materially captured and retransmitted to a new public. Another understanding is that a rather economic dependence should exist, where the “broadcaster” (i.e. the organisation in charge of the initial transmission) determines the content and the timing of the television programmes and the cable operator merely transmits the same programmes to another public. In this approach, it matters not whether the communication of this programme to the cable subscribers is technically operated on the basis of the publicly broadcast signal or on the basis of a simultaneous, directly injected signal. The Explanatory Memorandum does not express a preference for the one or the other interpretation.

The Danish copyright act seems to have chosen for the latter solution. In some of the Belgian cases discussed, it seems that there is some confusion on this point. The Court of appeal of Brussels, in its 1998 decision, sufficed to find that the broadcaster transmitted a signal to the cable operator, which received it and transmitted it to the public (notwithstanding that the direct injection by itself was not accessible to the general public). The Court of Appeal of Antwerp, in *Telenet*, explicitly stated that there was no cable retransmission in the technical sense (i.e. the reception of a broadcast signal and the subsequent transmission of this signal to the public of cable subscribers). Yet this Court of appeal at the same time found that there was a “*simultaneous, unaltered and unabridged transmission*” of a first broadcast and considered that the cable operator was bound to pay a remuneration for this activity.

**Responsibility for primary act of communication to the public by cable.** In those cases where the direct injection and the subsequent cable transmission are considered a single act of communication to the public, then the collective management of rights is no longer mandatory.

The question of the responsibility for this act (who is held to pay the remuneration?) is answered in different ways. Some courts impose the burden of the restricted act upon the cable operators<sup>467</sup>, others consider it the broadcasters’ role to acquire the right holders’ consent and provide it to the cable operator<sup>468</sup>. It could also be argued that it is more efficient for the broadcasters to clear all rights, since the broadcasters determine the content of the programmes and conclude a contract with the cable operators before making the programmes available for cable transmission<sup>469</sup>. The role of the collection societies is then to be determined by the parties (right holders, collecting societies, broadcasters and cable operators).

The consequence of qualifying the direct injection and the subsequent cable transmission as one (primary) act of communication to the public by cable is that the right holders’ consent is required once and that one remuneration is due for this unique restricted act. However, TRAPLE correctly points out

---

465 In favour of a more economic approach : E. TRAPLE, « TV signal delivery to cable operators and DTH platform operators », Jipitec 2011 (75) 86.

466 Explanatory Memorandum, SatCab Proposal, 36.

467 Cf. supra the decision of the Court of first instance of Brussels in 2005 (RTBF), the decision of the Hoge Raad in Chellomedia, where contracts with the cable operators existed, In Telenet, the Court of Appeal seemingly contradicted itself by finding that there was no cable retransmission and that Telenet had to pay a remuneration for the cable transmissions it makes)

468 Cf. decision of the Court of first instance of Mechelen in Telenet.

469 See on this point D. VISSER, « Primair openbaar maken via de kabel », AMI 2007/2 (37) 42-43.

that this complex act of cable transmission is monetised at different stages, by the broadcaster and by the cable operator<sup>470</sup>. The fact that a “public” is reached makes it possible for the broadcaster to close advertisement deals, while the cable operator receives the cable subscription fees. The right holders may consent to the cable transmission of the programmes with one party only and calculate the fees without a precise idea of the total financial return for all economic operators involved. This leads this author to conclude that the “*interpretation of the term “retransmission” to cover only transmission of a signal that was initially intended for reception by the general public leads to a significant limitation of the level of protection of right holders*”, contrary to the objective of the Directive (i.e. to create legal certainty for the cable operators as to the acquisition of rights and to ensure a high level of protection for the authors and right holders)<sup>471</sup>.

### c) Retransmission

After having examined some national decisions regarding the “initial transmission”, we will now analyse the second part of the definition, the “retransmission by cable”.

Article 1(3) of the Satellite and cable Directive defines the concept of cable retransmission as a “*simultaneous, unaltered and unabridged retransmission by a cable or microwave system for reception by the public*” of the initial transmission described above.

The issue here is whether a retransmission by other means than the traditional coaxial cable network are “retransmissions by cable” in the sense of the SatCab Directive. Regardless of the initial transmission, it has become common to access linear broadcast via other means than radio or television devices. Audio and audiovisual content is now listened to and watched, brought to end-users by all kinds of networks (Web, internet, mobile net) and devices (computers, mobile phones, “smart phones”, “tablets”). The operators of these new types of services share the concerns of the operators of traditional cable networks: how to clear the rights in time to transmit the programmes simultaneously to the original broadcast? Hence the question is whether these alternative networks can be assimilated to “cable and microwave systems”, in the sense of the SatCab Directive. If this is the case (technology-neutral approach), the operators of these new networks can turn to collecting societies to negotiate contracts for the retransmission of the broadcast “content”. If not (technology-specific approach), they have to clear the rights on an individual basis.

After having presented the issue of the approach used to define the retransmission “by cable”, we will examine the criterion of a “simultaneous, unaltered and unabridged retransmission”. Finally the retransmission by cable should be directed to a public<sup>472</sup>.

**Technology-neutral wording.** In the UK, the terms “retransmission by cable” receive a technology-neutral interpretation, so that the provision includes a retransmission through Internet.

The Austrian Supreme Court has issued a decision that addresses the question whether retransmissions by other means can be considered retransmissions by “cable”<sup>473</sup>. It ended up deciding the case on other

---

470 E. TRAPLE, « TV signal delivery to cable operators and DTH platform operators », Jipitec 2011 (75) 80.

471 E. TRAPLE, « TV signal delivery to cable operators and DTH platform operators », Jipitec 2011 (75) 84.

472 With regard to this condition, a recurring issue has been whether a cable retransmission to a circle of people should be qualified as a “reception” by means of a cable installation or as a protected act of cable retransmission. This condition will not be further examined in this study, given the CJEU’s decisions in inter alia SGAE, Phonographic Performance.. It may be mentioned here that one of the expert opinions of the Hungarian Copyright Expert Board assessed whether access to radio/television programming in hotel rooms (that is simultaneously in several rooms and by members of the public) is a reception of signals by the users (hotel guests) or retransmission through cable initiated and controlled by the hotel that receives the signals via satellite or cable. The expert body voted in favour of the second option. The expert body concluded that the cable retransmission by hotels is allowed only with the consent of the right holders and after the payment of royalties.

473 Austrian Supreme Court (Oberste Gerichtshof) 21 February 2008, 4Ob89/08d, accessible via <https://www.ris.bka.gv.at>.

grounds than the cable retransmission right<sup>474</sup>, but the decision still contains interesting considerations regarding the technology-specific or technology-neutral nature of the cable retransmission right.

The facts of the case were the following. A dispute had arisen between a private broadcasting organisation and a mobile network operator. The broadcasting organisation had acquired the exclusive rights for the matches of the Austrian football league for which it was realising the recordings of the matches. It had granted a sub-licence to the ORF (Örsterreichischer Rundfunk) for the free-to-air exploitation of the matches, so the ORF could broadcast the unaltered footage.

The defendant offered television programmes (including ORF1's) to its subscribers and streamed these via its mobile platform. The ORF broadcasting signal was first prepared in digital form: the publicly accessible signal was received "live", compressed, downscaled to a lower number of pixels (given the smaller size of mobile screens) and sent to the mobile devices in an encrypted data stream, via streaming servers.

The broadcaster brought an action against the mobile operator for the cessation of the use of its signal broadcasting the matches of the concerned leagues for the territories concerned and the transmission in a way that mobile devices can receive the signals, such as streaming. The Austrian Supreme Court had to determine whether the transmission of broadcast programmes should be qualified as transmission in the sense of art. 17, or retransmission according to art. 59a of the Austrian Copyright Act.

According to the Court, the Austrian legislator has chosen a technology-neutral wording for the retransmission right ("Weiterendung mit Hilfe von Leitungen"), which is not restricted to the transmission via a cable or micro-wave system. A transmission in that sense does not only cover the physical cable network but also wireless transmissions, hence streaming of a TV programme via UMTS mobile signal could be an integral cable retransmission by "lines" ("Leitungen"). In that case, cable operators should not conclude contracts with all right holders, but with the collecting societies. The Court reminded that the objective of the SatCab Directive was to lighten the burden of the cable operators, when it is not possible for practical reasons to acquire the rights in time of all people concerned by the retransmission. This ratio is not affected by the means of transmission: it does not depend on whether the cable operator transmits the broadcasts by means of wire or mobile broadcasting means, even if the mobile technology requires a modification of the signal and more time. The simultaneous character of the transmission makes it practically impossible to clear the rights in time.

Furthermore, the used technology for the retransmission is not relevant, according to the Court, as long as the receiver can only access the programme in a *passive way*, does not have any influence on the course or on the content of the transmission and cannot determine the time of the display on the mobile phone.

The Court decided that there was no reason to treat the mobile transmissions differently from the retransmission by cable in a strict sense and the microwave systems that existed in Ireland at the time the directive was adopted. The purpose of the regulation, to free the cable operators from individual rights management when the broadcasts are retransmitted in an integral, unaltered and simultaneous way is applicable to cable operators but to an equal extent to mobile phone operators:

---

474 Art. 59a:

1) The right to use broadcasts of works, including satellite broadcasts, for simultaneous, complete and unchanged retransmission by cable may only be asserted by collecting societies; however, this shall not apply to the right to institute proceedings for infringement of copyright.

(2) Broadcasts may be used for retransmission within the meaning of paragraph (1) if the retransmitting broadcasting organization has authorization to make such use from the competent collecting society. With reference to such authorization, authors who have not entered into a representation contract with the collecting society and whose rights are not asserted under an agreement on reciprocity with a foreign collecting society, shall enjoy the same rights and obligations as the beneficiary of the collecting society.

(3) Paragraphs (1) and (2) shall not apply, however, where the right of retransmission within the meaning of paragraph (1) is held by the broadcasting organization whose broadcast is retransmitted.

In the present case, the Court decided the case based on the notion of “broadcasting” . The Austrian Copyright Act gives the author the exclusive right to broadcast her work (art. 17) and it assimilates the transmission via “lines” (“*Leitungen*”) to a broadcast<sup>475</sup>. It came to the conclusion that the integral, substantially unaltered and merely technically delayed transmission of the television programmes of ORF in Austria by means of streaming via a UMTS mobile network is a part of the original broadcast (art. 17, 3 of the Austrian Copyright Act). As the claimant had authorised the ORF to exploit broadcast signal by means of television broadcasts, the defendant did not infringe the claimant’s rights.

**Technology-specific wording.** Other Member States provide a technology-specific cable retransmission right. That right was analysed by the Court of First Instance in Hamburg in a case opposing film producers (Warner, Universal) and the operator of an online service. This service was restricted to the German territory where broadcast programmes could be accessed via internet at the same time these are broadcast via free-to-air TV<sup>476</sup>.

The claimants had granted licences covering the free-to-air broadcast of the films in Germany, with a clause excluding the transmission “online” resp. via mobile or Internet technologies. However, the defendant had captured the broadcast signal (by satellite or other technologies), changed the format and encrypted the signal (at the servers of the defendant), and then transferred it to an internet node for retransmission. The defendant had concluded contracts with the broadcasters, in which its services were qualified as cable retransmissions in the sense of art. 20b of the German Copyright Act. The issue was whether the retransmission via the internet of broadcast programmes is a cable retransmission in the sense of that provision.

The German Copyright Act provides a general provision regarding the exploitation rights (art. 15). It holds a general right of communication to the public (“*Recht der öffentlichen Wiedergabe*”), which encompasses a transmission or broadcasting right (“*Senderecht*”)<sup>477</sup> and a right of making available to the public (*Recht der öffentlichen Zugänglichmachung*)<sup>478</sup>. According to art. 20b, the right of retransmission by cable

475 Art. 17 of the Federal Law on Copyright in Works of Literature and Art and on Related Rights:

“1) The author shall have the exclusive right to broadcast his work by radio, television on similar means.

(2) Where a work is publicly communicated in Austria by an entity located inside or outside the country in a manner comparable to broadcasting but with the aid of conductors, such communication shall be assimilated to broadcasting.

(3) The communication of broadcasts

1. by a broadcasting relay system and

2. via a community antenna system,

(a) where all the receivers are located only on contiguous pieces of ground, where no part of the system uses or crosses a public road and where the antenna is not more than 500 meters away from the nearest receiver, or

(b) where not more than 500 participants are connected to the system,

shall not be regarded as a new broadcast. In other respects the simultaneous communication, with the aid of conductors, of complete broadcasts of the Austrian Broadcasting Organization.”

476 LG Hamburg 8 April 2009, nr. 308 O 660/08, accessed via <http://rechtsprechung.hamburg.de> on 19 February 2012.

477 Art. 20 of the German Copyright Act: The right of broadcasting is the right to make a work available to the public by broadcasting, such as radio and television transmission, satellite transmission, cable transmission or by similar technical means.

478 Art. 15 of the German Copyright Act:

(1) The author has the exclusive right to exploit his work in material form; this right shall in particular include

1. the right of reproduction (Article 16),

2. the right of distribution (Article 17),

3. the right of exhibition (Article 18).

(2) The author further has the exclusive right to communicate his work to the public in non-material form (right of communication to the public). The right of communication to the public shall comprise in particular

1. the right of recitation, performance and presentation (Article 19),

2. the right of making the work available to the public (Article 19a),

(“Kabelweitersendung”) can only be exercised by a collecting society, except for broadcasting organisations<sup>479</sup>.

The Court of Hamburg decided that the retransmission of broadcast programmes over the Internet is not a cable retransmission in the sense of the German Copyright Act. It refused to interpret the notion of “cable retransmission” in a technology-neutral way. By consequence the collective management was not mandatory. It found an infringement of the transmission right or the right of making available, by communicating the films to the public via internet at the same time as the broadcast via free-to-air TV.

As to the application of art. 20b of the German Copyright Act, the Court found that the wording of that provision was not conclusive. The Court considered that it does not define which technologies are targeted and the *travaux préparatoires* contain no further explanation. The Court found similarities between the network infrastructure of defendant and coaxial cable networks; moreover, taking only the wording of the provision into consideration, this internet network could be seen as a cable system in the sense of the act. However, the Court considered that the historical context and the system of exploitation rights in the German Copyright Act form an obstacle to such interpretation. Inspired by the SatCab Directive, the object of the regulation was the retransmission of television and radio programmes via the proprietary coaxial cable network. The “microwave system” referred to a particular technology only used in Ireland. The possibility of retransmitting works via the Internet was not yet well known at that time and the business model was not yet developed. The legislator did not have the objective to regulate this mode of transmission or any generic “cable” for that matter. The preparatory works of the Directive show no indications that “cable retransmission” was meant to be a technology-neutral notion. Furthermore, in its 2002 report, the Commission adopted an opinion *contra* the extension of this notion to internet transmissions.

According to the Court, the provision on cable retransmissions entails a limitation of the rights, which should be interpreted narrowly. By principle, copyright’s exploitation rights are managed on an individual basis. The law impose the collective management of rights only if the burden of clearing the rights (due to the massive number of licences required) makes the operation impossible and if the right holders have not individually agreed to collective management of their rights. In that case individual right holders have no influence on whether or to whom the use of the work is authorised and that constitutes an important

3. the right of broadcasting (Article 20),

4. the right of communication by video or audio recordings (Article 21),

5. the right of communication of broadcasts and of works made available to the public (Article 22).

(3) The communication of a work shall be deemed public if it is intended for a plurality of members of the public. Anyone who is not connected by a personal relationship with the person exploiting the work or with the other persons to whom the work is made perceivable or made available in non-material form shall be deemed to be a member of the public.

479 Art. 20b German Copyright Act :

(1) The right to retransmit a transmitted work in the context of a simultaneous, unaltered and unabridged retransmission of a program by means of cable systems or microwave systems (cable retransmission) may be asserted only by a collecting society. This shall not apply to rights asserted by a broadcasting organisation in respect of its broadcasts.

(2) Where the author has granted the right of cable retransmission to a broadcasting organisation or to the producer of an audio recording or film, the cable operator shall nevertheless pay the author an equitable remuneration for the cable retransmission. The claim for remuneration may not be waived. It may be assigned in advance only to a collecting society and may be asserted only by a collecting society. This provision shall not conflict with the collective agreements, works agreements and joint remuneration agreement of broadcasting organisations insofar as the author is thereby granted equitable remuneration for each cable retransmission.

A new bill presented in February 2013 proposed to review art. 20b German Copyright Act and to give a technology neutral sense to the right of retransmission by cable. See X, “Referentenentwurf des Bundesministeriums der Justiz, Entwurf eines Gesetzes zur Nutzung verwaister Werke und zu weiteren Änderungen des Urheberrechtsgesetzes und des Urheberrechtswahrnehmungsgesetzes, Digitale Linke, 20 February 2013, accessible via <http://blog.die-linke.de/digitalelinke/wp-content/uploads/Ref.Entwurf.pdf>. However, that proposal was later withdrawn and does not exist anymore in the version of the bill presented by the Government in April 2013. See an updated version of this document (5 April 2013) via [http://www.bmj.de/SharedDocs/Downloads/DE/pdfs/RegE\\_Gesetzes\\_zu\\_Nutzung\\_verwaister\\_Werke\\_und\\_zu\\_weiteren\\_Aenderung\\_en\\_des\\_Urheberrechtsgesetzes\\_und\\_des\\_Urheberrechtswahrnehmungsgesetzes.pdf?\\_\\_blob=publicationFile](http://www.bmj.de/SharedDocs/Downloads/DE/pdfs/RegE_Gesetzes_zu_Nutzung_verwaister_Werke_und_zu_weiteren_Aenderung_en_des_Urheberrechtsgesetzes_und_des_Urheberrechtswahrnehmungsgesetzes.pdf?__blob=publicationFile).



restriction of the right holder's rights. The Court acknowledged that an internet operator may have the same interest in such facilitated management of rights (given the similarity of the retransmissions by cable and by internet network). Nevertheless, this mandatory regime cannot be extended to new exploitations but for a decision of the legislator. Moreover, the retransmission via the internet is different, from a qualitative point of view, given its open and decentralised character, it is organised in a simpler and cheaper way and its reach can be easily increased.

Finally, the Court in Hamburg decided that the decision of the Austrian Supreme Court could not have any influence on the case it was deciding. It considered it as a decision on a particular national rule, a decision of the Austrian legislator to implement the Directive in a lenient way, without referring to the cable and microwave systems but to "lines" ("Leitungen"). Unlike the German legislator, the Austrian legislator decided to implement the Directive in a technology-neutral way and it is a specific provision with merely national impact.

In Poland and in France, the concept of cable retransmission is technology-specific and limited to "retransmission via cable". It is the same in Denmark where the cable retransmission is provided to "retransmission via cable system" and "retransmission by means of radio systems".

The Italian Copyright Act is rather technology-specific with regard to the types of transmissions that should be covered by the retransmission right, whereas the same provision is neutral when referring to the modes of technical diffusion of the retransmitted broadcasts (art. 16-bis, c) Italian Copyright Act). If the retransmission of a primary radio- or TV broadcasting emission coming from another EU Member State occurs through a system of cable redistribution or through very high frequencies, and the retransmission is addressed to the public, the right created under art. 16-bis (i.e., the retransmission right of the SatCab Directive) applies irrespectively of the modes of the initial broadcast diffusion. Unfortunately, the case law has not clarified the exact meaning and the scope of the retransmission via cable after the transposition of the 1993 SatCab Directive into Italian law. However, it seems generally accepted that Italian law intended to define this particular type of right in a technology-specific way. As a result, transmissions occurring through other types of networks (mobile telephony or online transmissions) are not retransmissions by cable. Consequently, there is no mandatory collective management for exploitation via these means and the authorisation should be sought in accordance with the default regime applicable to other communications to the public.

**Simultaneous, unaltered and unabridged.** According to art. 1(3) of the Satellite and cable Directive, the retransmission must be simultaneous, unaltered and unabridged.

The retransmission by cable should be simultaneous to the initial transmission. According to HUGENHOLTZ, this entails that delayed retransmissions are no "retransmissions" and neither are, incomplete transmission (e.g. if the advertisement in the broadcast is cut or replaced by the cable operator). However, "*the application of mere technical procedures, such as analogue-to-digital signal conversions, remains within the ambit of the definition*"<sup>480</sup>.

In its abovementioned decision<sup>481</sup>, the Austrian Supreme Court found that the notion of "simultaneous" should not be understood in a strictly physical sense, but as a contrast to delayed transmissions or displays from recordings ("Aufzeichnungswiedergabe").

The retransmission by cable should also be unaltered. The broadcaster determines the composition of the programmes that it will broadcast (including by satellite). The cable operator that retransmits this primary broadcast cannot make up his programmes on the basis of a portfolio of rights which he has acquired beforehand. The cable operator can decide only whether he wants to retransmit the primary

---

480 P.B. HUGENHOLTZ, « SatCab Revisited : the past, present and Future of the Satellite and Cable Directive », IrisPlus 2009/8 (7), 12.

481 Austrian Supreme Court (Oberste Gerichtshof) 21 February 2008, 4Ob89/08d, accessible via <https://www.ris.bka.gv.at>, p. 9.

broadcast in full or not at all<sup>482</sup>. If the cable operator, by contrast, decides to alter the initial broadcasts, the circumstances that justify this regime of mandatory collective management are no longer present. This was confirmed by the Austrian Supreme Court in its abovementioned ruling<sup>483</sup>. The Court also clarified that the unaltered character of the retransmission pertains to the retransmitted programmes, not the technical information support. Moreover, the Court considered there was an unabridged retransmission if the live retransmission by streaming over the UMTS mobile network if the final user experiences a marginal time delay.

In Denmark, the initial transmission's signal has to be captured and transformed to be retransmitted by cable, in a technical sense.

**Summary.** The few national decisions we have found bring no conclusive answer to the questions asked. Austria understands the retransmission by cable or microwave system in a technology-neutral way, whereas Germany sticks to a technology-specific understanding of the retransmission right. Other Member States seem to consider the retransmission by cable as a technology-specific form of communication. It is not known how contractual practice has developed between the right holders, the collecting societies and the alternative network operators.

At stake is the scope of the obligation of collective management of the cable retransmission right. If this right is understood in a technology-specific way, then only the retransmission of broadcasts via the traditional cable networks and the MMDS network (Ireland) are subject to this obligation. Other simultaneous retransmissions should be cleared on an individual basis. If by contrast the cable retransmission right is interpreted in a technology-neutral way, then the mandatory regime can be applicable to all operators in a comparable situation as the cable operators.

In 2002, the Commission did not consider it appropriate to extend the mandatory collective-management regime to categories of retransmission other than the retransmission by coaxial cable. The economic study should assess whether there is a need now for such an extension.

### III. Conclusions

In this Study we have discussed the cable retransmission right, as understood in the SatCab Directive. We have started by outlining the issues arising from the application of this right (*sub II.A*), then we have described the legal context in which the initiative to regulate the exercise of the cable retransmission was taken (*sub II.B.1*). We have presented the scope of application of the SatCab Directive and its relation to the Information Society Directive (*sub II.B.2*). Then we have examined the elements of the notion "retransmission by cable" (*sub II.B.3*).

**Cable retransmission right and right of communication to the public.** We have examined the decisions of the CJEU on cases involving a transmission via a cable network. It was concluded that the CJEU has been consistent in its approach to assess the question of the protection of such cable transmissions in relation to the InfoSoc Directive, rather than the SatCab Directive. The existence, definition and scope of the cable retransmission right have not been regulated as such in the SatCab Directive, which only requires the collective management of the cable retransmission right (letting alone under which legal heading it is protected).

**Initial transmission.** We have discussed some Dutch and Belgian cases and we have described the Danish provisions. The main issue regarding the initial transmission appears to be the qualification of direct communications between the "broadcaster" and the cable operator (e.g. "direct injection").

---

482 Explanatory Memorandum, Proposal, 23, 43.

483 Austrian Supreme Court (Oberste Gerichtshof) 21 February 2008, 4Ob89/08d, accessible via <https://www.ris.bka.gv.at>, p. 9-10.

There seems to be no uniform understanding of the notion “*initial transmission from another Member State, by wire or over the air, including that by satellite, of television or radio programmes intended for reception by the public*” (art. 1(3) SatCab Dir). Most courts require a “public”, as interpreted by the CJEU in *Lagardère* and subsequent cases, both for the initial transmission and for the retransmission.

The relation between the initial transmission and the retransmission is not clarified. The consideration that the cable operator “depends” on the initial transmitter is sometimes understood in a literal way, as a technical requirement that the cable transmitter should *receive* the signal and *retransmit* that signal of the initial transmitter. In other cases, it suffices that there is a simultaneous initial transmission (cf. Denmark). The explanatory memorandum of the Commission did not define the relation between the primary and the secondary transmission in a conclusive way.

### **Retransmission by cable.**

We have then analysed two national decisions with relevance for the right of retransmission by cable. In the Austrian Copyright Act, the retransmission right includes all secondary retransmissions, regardless of the technology or the nature of the network (including the mobile network). The Austrian legislator has explicitly opted for a technology-neutral transposition of the cable retransmission right (*Leitungen*). The cable retransmission right in the German Copyright Act by contrast does not extend to other technologies, such as the Internet. The cable retransmission right was transposed in a technology-specific way. This has consequences on the scope of application of the mandatory collective management of the retransmission right.

## Bibliography

### Legislation

Berne Convention for the Protection of Literary and Artistic Works of September 9, 1886, completed at Paris on May 4, 1896, revised at Berlin on November 13, 1908, completed at Berne on March 20, 1914, revised at Rome on June 2, 1928, at Brussels on June 26, 1948, at Stockholm on July 14, 1967 and at Paris on July 24, 1971 and amended on September 28 1979.

Council Directive 89/552/EEC of 3 October 1989 on the coordination of certain provisions laid down by Law, Regulation or Administrative Action in Member States concerning the pursuit of television broadcasting activities, *OJ L 298, 17.10.1989, p. 23–30*, now Directive 2010/13/EU of the European Parliament and of the Council of 10 March 2010 on the coordination of certain provisions laid down by law, regulation or administrative action in Member States concerning the provision of audiovisual media services (Audiovisual Media Services Directive) (Text with EEA relevance), *OJ L 95, 15.4.2010, p. 1–24*.

Council Directive 93/83/EEC of 27 September 1993 on the coordination of certain rules concerning copyright and rights related to copyright applicable to satellite broadcasting and cable retransmission, *Official Journal L 248, 06/10/1993, 15-21*.

Proposal for a Council Directive on the coordination of certain rules concerning copyright and neighbouring rights applicable to satellite broadcasting and cable retransmission, Explanatory Memorandum, COM(91) 276 final – SYN 358, 1991.

Directive 2001/29/EC of the European Parliament and of the Council of 22 May 2001 on the harmonisation of certain aspects of copyright and related rights in the information society, *Official Journal L 167, 22/06/2001, 10-19*.

#### ▪ Austria

Federal Law on Copyright in Works of Literature and Art and on Related Rights (Copyright Act) (as last amended in 1998), accessed via [http://www.wipo.int/wipolex/en/text.jsp?file\\_id=124839](http://www.wipo.int/wipolex/en/text.jsp?file_id=124839).

#### ▪ Belgium

Loi du 30 juin 1994 relative au droit d'auteur et aux droits voisins, *MB 27 July 1994*, last amendment on 31 December 2012, accessible via [http://www.ejustice.just.fgov.be/cgi\\_loi/change\\_lg.pl?language=fr&la=F&cn=1994063035&table\\_name=loi](http://www.ejustice.just.fgov.be/cgi_loi/change_lg.pl?language=fr&la=F&cn=1994063035&table_name=loi). No updated English translation found.

#### ▪ Denmark

Consolidated Act No. 202 of 27 February 2010 on Copyright (Bekendtgørelse af lov om ophavsret), LBK nr 202, Offentliggørelsesdato: 09-03-2010, accessible via [http://www.wipo.int/wipolex/en/text.jsp?file\\_id=191420](http://www.wipo.int/wipolex/en/text.jsp?file_id=191420).

#### ▪ France

Code de la propriété intellectuelle, version consolidée au 2 mars 2013, accessible via <http://www.legifrance.gouv.fr/affichCode.do?cidTexte=LEGITEXT000006069414&dateTexte=20130627>. An English translation is available via [http://www.legifrance.gouv.fr/content/download/1959/13723/version/3/file/Code\\_35.pdf](http://www.legifrance.gouv.fr/content/download/1959/13723/version/3/file/Code_35.pdf). This version however does not reflect the latest amendments to the law.

- **Germany**

Copyright Act of 9 September 1965 (Federal Law Gazette Part I, p. 1273), as last amended by Article 83 of the Act of 17 December 2008 (Federal Law Gazette Part I, p. 2586) accessible via [http://www.gesetze-im-internet.de/englisch\\_urhg/englisch\\_urhg.html#p0282](http://www.gesetze-im-internet.de/englisch_urhg/englisch_urhg.html#p0282)

- **Hungary**

Act LXXVI of 1999 on Copyright (consolidated text as of January 1, 2012) accessible via [http://www.artisjus.hu/userfiles/hungarian\\_copyright\\_act.pdf](http://www.artisjus.hu/userfiles/hungarian_copyright_act.pdf).

- **Italy**

Law for the Protection of Copyright and Neighbouring Rights (Law No. 633 of April 22, 1941, as last amended by Legislative Decree No. 68, of April 9, 2003) accessible via [http://portal.unesco.org/pv\\_obj\\_cache/pv\\_obj\\_id\\_9CA7CDBB888D11C81CF4F9D1B31F77FF69BE1200/filename/it\\_copyright\\_2003\\_en.pdf](http://portal.unesco.org/pv_obj_cache/pv_obj_id_9CA7CDBB888D11C81CF4F9D1B31F77FF69BE1200/filename/it_copyright_2003_en.pdf).

- **Luxembourg**

Loi du 18 avril 2001 sur les droits d'auteur, les droits voisins et les bases de données, accessible via <http://www.sacem.lu/cmsdata/documents/Recueil%20de%20textes.pdf>. No English translation was found.

- **The Netherlands**

Act of September 23, 1912 Containing New Regulation for Copyright (Copyright Act 1912, as last amended on April 1, 2006), accessible via [http://www.wipo.int/wipolex/en/text.jsp?file\\_id=249663](http://www.wipo.int/wipolex/en/text.jsp?file_id=249663).

Wet van 18 maart 1993, houdende regelen inzake de bescherming van uitvoerende kunstenaars, producenten van fonogrammen of van eerste vastleggingen van films en omroeporganisaties en wijziging van de Auteurswet 1912, via <http://wetten.overheid.nl/BWBR0005921/>.

- **Poland**

Act of February 4, 1994 on copyright and related rights, accessible via [http://en.wikisource.org/wiki/Polish\\_Copyright\\_Law#cite\\_note-1](http://en.wikisource.org/wiki/Polish_Copyright_Law#cite_note-1).

- **Spain**

Consolidated text of the Law on Intellectual Property, regularizing, clarifying and harmonizing the Applicable Statutory Provisions (approved by Royal Legislative Decree No. 1/1996 of April 12, 1996, and last amended by Royal Decree No. 20/2011 of December 30, 2011), Spanish version via [http://www.wipo.int/wipolex/en/text.jsp?file\\_id=244508](http://www.wipo.int/wipolex/en/text.jsp?file_id=244508).

- **United Kingdom**

The United Kingdom: Copyright, Designs and Patents Act 1988, accessible via <http://www.legislation.gov.uk/ukpga/1988/48/contents>.

## Court decisions

CJEU 3 February 2000, Case C-293/98, *Entidad de Gestión de Derechos de los Productores Audiovisuales (Egeda) v Hostelería Asturiana SA (Hoasa)*, Reports of Cases 2000 I-00629, Opinion of the Advocate General La Pergola delivered on 9 September 1999.

CJEU 2 June 2005, Case C-89/04, *Mediakabel BV v Commissariaat voor de Media*, *Reports of Cases* 2005 I-04891

CJEU 14 July 2005, Case C-192/04, *Lagardère Active Broadcast v Société pour la perception de la rémunération équitable (SPRE) and Gesellschaft zur Verwertung von Leistungsschutzrechten mbH (GVL)*, Reports of Cases 2005 I-07199.

CJEU 1 June 2006 Case C-169/05, *Uradex SCRL v Union Professionnelle de la Radio et de la Télédistribution (RTD) and Société Intercommunale pour la Diffusion de la Télévision (BRUTELE)*.

CJEU, 7 December 2006, C-306/05, *SGAE v. Rafael Hoteles*.

CJEU, Order of the Court of 18 March 2010, C-136/09, *Organismos Sillogikis Diacheirisis Dimiourgon Theatrikon kai Optikoakoustikon Ergon v Divani Akropolis Anonimi Xenodocheiaki kai Touristiki Etaireai*.

CJEU 13 October 2011, Joined cases C-431/09 and C-432/09, *Airfield NV and Canal Digitaal BV v Belgische Vereniging van Auteurs, Componisten en Uitgevers CVBA (Sabam) (C-431/09) and Airfield NV v Agicoa Belgium BVBA (C-432/09)*.

CJEU, 15 March 2012, C-162/10, *Phonographic Performance v. Ireland*.

CJEU 7 March 2013, Case C-607/11, *ITV Broadcasting Ltd and Others v TV Catch Up Ltd*.

CJEU, Order of the president of the court, 22 May 2013, Case C-416/12, *Wikom Deutsche Telekabel (anciennement Wikom ElektriK)*.

### ▪ Austria

Austrian Supreme Court (Oberste Gerichtshof) 21 February 2008, 4Ob89/08d, accessible via <https://www.ris.bka.gv.at>.

### ▪ Belgium

Bruxelles 25 June 1998, *AM* 1999, 212.

Civ. Bruxelles 27 January 2005, *RTBF v Société Intercommunale Namuroise de Télédistribution e.a.*, *AM* 2005/2, 138.

Rb. Mechelen 12 April 2011, *I.R. D.I.* 2011, 238, « Telenet »

Antwerpen 4 February 2013, 2011/AR/1523, 2011/AR/2545, 2011/AR/2546, 2011/AR/2578, 2011/AR/2582, *SABAM e.a. c Telenet*, *unpublished*.

Trib. comm. Bruxelles 29 January 2013, RG nr. 5865/11, *Société des Auteurs et Compositeurs Dramatiques (SACD), Société Civile des Auteurs Multimédia (SCAM), Société Multimédia des Auteurs des arts Visuels (SOFAM) c Coditel*, *unpublished*.

- **Germany**

LG Hamburg 8 April 2009, nr. 308 O 660/08, accessed via <http://rechtsprechung.hamburg.de> on 19 February 2012.

- **The Netherlands**

Court Amsterdam 12 January 2005, AMI 2005, 135-139, Buma/Stemra v UPC.

Court of Appeal Amsterdam 29 June 2006, AMI 2007/1, 11, Buma/Stemra v Chellomedia (previously UPC).

Rb. Den Haag 28 January 2009, case nr. 271796 / HA ZA 06-2844, NORMA v Vereniging NLKabel, *IEPT* 20090128, [www.ie-portal.nl](http://www.ie-portal.nl).

Hoge Raad 19 June 2009, LJN BH7602, 07/12553, Vereniging Buma v Chellomedia Programming, [www.rechtspraak.nl](http://www.rechtspraak.nl).

Rb. Amsterdam, 25 November 2010, [http://www.boek9.nl/files/2010/IEPT20101125\\_Rb\\_Amsterdam\\_Cedar\\_v\\_Digitenne.pdf](http://www.boek9.nl/files/2010/IEPT20101125_Rb_Amsterdam_Cedar_v_Digitenne.pdf).

Gerechtshof 's Gravenhage 10 April 2012, case nr 200.036.425/01, NORMA v Vereniging NLKabel e.a., *IER* 2012, 38, [www.rechtspraak.nl](http://www.rechtspraak.nl);

### Scholarly literature

AXHAMN, J., & GUIBAULT, L., *Cross-border extended collective licensing: a solution to online dissemination of Europe's cultural heritage?*, 2011, retrieved via [http://www.ivir.nl/publicaties/guibault/ECL\\_Europeana\\_final\\_report092011.pdf](http://www.ivir.nl/publicaties/guibault/ECL_Europeana_final_report092011.pdf).

CORBET, J., "Verslag van 26 juli van de Europese Commissie (toepassing van de richtlijn van de Raad over de satellietomroep en de kabeldistributie, COM (2002) 430 def), *A&M* 2003/3, 198-202.

DREIER, Th., "Satellite and Cable Directive" in M. M. WALTER & S. VON LEWINSKI (ed), *European Copyright Law*, Oxford, University Press, 2010, 419 (hereafter, DREIER, "Satellite and Cable Directive").

FOGED, T., "DTT primary transmission and retransmission – copyright challenges", [http://www.ubod.dk/fileadmin/user\\_upload/ubo/articles/TF\\_article.pdf](http://www.ubod.dk/fileadmin/user_upload/ubo/articles/TF_article.pdf), 3 September 2009, 15 p.

GHYS, M., « C'était un soir, messieurs, mesdames,... mais la télé n'a jamais été en panne... », *A&M* 2006, 221-231.

HUGENHOLTZ, P.B., "Copyright without Frontiers: is there a future for the Satellite and Cable Directive?", *Die Zukunft der Fernsehrichtlinie/The Future of the 'Television without Frontiers' Directive*, Band 29, Nomos Verlag, Baden-Baden, 2005, accessed via [www.ivir.nl](http://www.ivir.nl).

HUGENHOLTZ, P.B., "SatCab Revisited: the past, present and Future of the Satellite and Cable Directive", *IrisPlus* 2009/8 (7), 16.

HUGENHOLTZ, P.B., "Convergence, Copyrights and Transfrontier Television", *Iris plus*, 2009/8, 16.

MAQUA, A. & VANBOSSELE, F., "De Coditel à Telenet. Le nouveau périmètre de la « communication au public » des programmes de télévision linéaires", *RDTI* 2011/3, 5-25.

ROSEN, J., "News from the Nordic countries", *R.I.D.A.*, 2011, n° 229, 183.

TRAPLE, E., "TV signal delivery to cable operators and DTH platform operators", *Jipitec* 2011 (75).

VISSER, D., "Primair openbaar maken via de kabel", *AMI* 2007/2 (37).

WERKERS, E., "Broadbank Content Services : Intellectual Property Rights at War with Convergence?", (August 24, 2006). Available at SSRN: <http://ssrn.com/abstract=1923695> or <http://dx.doi.org/10.2139/ssrn.1923695>.

X, "Referentenentwurf des Bundesministeriums der Justiz, Entwurf eines Gesetzes zur Nutzung verwaister Werke und zu weiteren Änderungen des Urheberrechtsgesetzes und des Urheberrechtswahrnehmungsgesetzes, *Digitale Linke*, 20 February 2013, accessible via <http://blog.die-linke.de/digitalelinke/wp-content/uploads/Ref.Entwurf.pdf>

## Reports and communications

Guide to the Berne Convention for the Protection of Literary and Artistic works (Paris Act, 1971), World Intellectual Property Organisation, Geneva, 1978.

Discussion Paper "Broadcasting and copyright in the internal market", prepared by the Commission of the European Communities on copyright questions concerning cable and satellite broadcasts, III/F/5263/80-EN, November 1990, 26-35.

Report from the Commission on the application of Council Directive 93/83/EEC on the coordination of certain rules concerning copyright and rights related to copyright applicable to satellite broadcasting and cable retransmission, COM(2002) 430 final, 26 July 2002, 5 (hereafter 2002 Commission Report).







DE WOLF & PARTNERS

## **PART II : Exceptions in the digital environment**

In collaboration with the CRIDS







## The limitations and exceptions to copyright and related rights for libraries, research and teaching uses



By **Séverine DUSOLLIER**, Professor at the University of Namur, Director of CRIDS (Centre de Recherche Information, Droit et Société)

with the collaboration of Caroline COLIN, Rosario DEBILIO, Sandrine HALLEMANS, Researchers at CRIDS (Centre de Recherche Information, Droit et Société)

This part of the Study, with the Commission's approval, was commissioned by Jean-Paul TRIAILLE to the CRIDS. Jean-Paul TRIAILLE coordinated the overall Study.

The authors thank the following persons for their valued contributions to this Study: Maciej BARCZEWSKI (attorney-at-law, and Head of Postgraduate Program in Intellectual Property and High Technology Law, University of Gdansk), Stéphanie CARRÉ (Maître de Conférences, CEIPI, Université de Strasbourg), Estelle DERCLAYE (Professor of Intellectual Property Law, Faculty of Social Sciences, University of Nottingham), Giuseppe MAZZIOTTI (Center for European Policy Studies), Peter MEZEI (Assistant Professor at University of Szeged), Sylvie NÉRISSON (Max Planck Institute for Intellectual Property and Competition Law, Munich), Thomas RIIS (Professor at University of Copenhagen, Faculty of Law), Raquel XALABARDER PLANTADA (Vicerectorat d'Ordenació Acadèmica i Professorat Directora Adjunta, Universitat Oberta de Catalunya).

The responsibility for this Study and for the opinions expressed herein remains with its author(s).



## Introduction

Amongst exceptions admitted by the article 5 of the Directive 2001/29/EC of 22d of May 2001 on some aspects related to copyright in the information society, some uses are privileged on the ground that they partake to transfer of knowledge and education. This is the case of exceptions benefiting to libraries or educational institutions. Within defined limits, libraries are allowed to make certain acts of reproduction of works they hold in their collection as well as making them available to the public for on-the-spot viewing and reading. Likewise, teachers and students can use works when needed to illustrate the educational activity, and researchers are entitled to reproduce and communicate works for the strict purpose of research.

In its review of the Single Market<sup>484</sup> the European Commission considered the free movement of knowledge and innovation as the "Fifth Freedom" in the single market. One year later, the Green Paper on Copyright in the Knowledge Economy<sup>485</sup> highlighted the need to assess whether the exceptions and limitations to copyright and related rights that enable the public dissemination of knowledge, notably through libraries, educational and research institutions, were still fit for their purpose in the digital environment. The Communication that followed up the Green Paper<sup>486</sup> announced some actions from the European Union to accommodate changing needs and issues of exceptions, some of them having already been unfolded, such as the directive on orphan works<sup>487</sup>; the Memorandum of Understanding on Digitisation and making available of out-of-commerce works<sup>488</sup>, or the Licenses for Europe initiative that purports to develop licensing solutions for some uses of copyrighted works.

None of these initiatives have revised the exceptions of the directive 2001/29 so far. This chapter aims at assessing whether there is a need to adapt limitations and exceptions provided for teaching and research to the digital environment in order to ensure that their application remains relevant – while, at the same time, ensuring the required balance with right-holders' legitimate interests and the normal exploitation of the work and other protected subject matter. This concerns the exceptions laid down in the article 5(2) c) (certain acts of reproduction by libraries, educational institutions, museums and archives), article 5(3) n) (making available for consultation on the premises of the same establishments) and article 5(3) a) (uses for illustration of teaching and for scientific research).

Another activity of the library is equally relevant to disseminate works and cultural content to the public. It is the public lending right whose regime is governed by the article 6 of the Rental and Lending directive<sup>489</sup>. With the advent of e-books and online delivery of digital versions of literary works, digital forms of lending are increasingly envisaged and experimented by libraries, which justifies to study whether the public lending right that exists in most Member States, but limited to tangible copies of works, could and should be updated so as to cover digital transmissions.

This chapter will begin by a general analysis of the system of exceptions to copyright and related rights in EU law (I) that will serve as the background for the study of the exceptions for libraries and for teaching and research. A second part will address the activities and exceptions relevant for libraries and similar

---

<sup>484</sup> *A single market for 21st century Europe*, 20.11.2007, COM (2007) 724 final.

<sup>485</sup> *Green Paper on Copyright in the Knowledge Economy*, 16.7.2008, COM(2008) 466 final.

<sup>486</sup> Communication of the Commission, *Copyright in the Knowledge Economy*, 19.10.2009, COM(2009) 532 final.

<sup>487</sup> Directive 2012/28/EU of the European Parliament and of the Council of 25 October 2012 on certain permitted uses of orphan works, OJ L 299 of 27 October 2012.

<sup>488</sup> Memorandum of Understanding, Key Principles on the Digitisation and Making Available of Out-of-Commerce Works, 20 September 2011.

<sup>489</sup> Directive 2006/115/EC of the European Parliament and of the Council of 12 December 2006, OJ L 376/28 of 27 December 2006.

institutions, covering certain uses of works and other protected subject matter by libraries, which will cover the reproduction for preservation purposes, the on-site consultation and the e-lending (II). The last part will examine the exception for teaching and research (III).

## I. The system of copyright exceptions in EU law

### A. The exceptions in the *acquis communautaire*

Exceptions to copyright and related rights are provided by four directives at the European level: the Software directive 2009/24/EC<sup>490</sup>, the Rental and Lending Directive 2006/115/EEC<sup>491</sup>, the Database directive 96/9/EC<sup>492</sup>, and the InfoSoc Directive 2001/29/EC<sup>493</sup>.

The four directives co-exist<sup>494</sup>, as stated by the article 1(2) of the InfoSoc Directive that has left intact the earlier Community legislation, which begs the question of the conciliation or absorption of the exceptions they provide. This last directive is the more horizontal as it aims at harmonizing the exceptions to copyright and related rights and applies to all types of works at the exception of computer programs and databases that are left to their respective directives. The articulation of these four directives as to their exceptions is nevertheless an intricate issue that is not resolved<sup>495</sup>.

One clear rule is that the exceptions in the vertical directives applying to computer programs and databases are considered as being *lex specialis*, as those directives confer privileges of use that are tailored to the specific subject matter of the computer program or the database, and have been left intact by the InfoSoc Directive of 2001.

As far as **software** is concerned, the traditional exceptions might not fit well with the specific character and the functional features of the computer program anyway<sup>496</sup>, but this position is contradicted, as we will see below, by the increasing inclusion of computer programs and video games in the practices allowed under copyright exceptions.

On the **database** front, the article 6(2) of the Database Directive authorises Member States to adopt limitations known for other types of works, such as private copying (limited to non-electronic database), use for illustration for teaching or scientific research, use for public security or administrative or judicial procedure. Additionally, "exceptions to copyright which are traditionally authorised under national law" can also be applied to databases protected by copyright, which is a "rather opaque provision"<sup>497</sup> that can be

---

<sup>490</sup> Directive 2009/24/EC of 23 April 2009 on the legal protection of computer programs, OJ L 111/16, 5.5.2009 (codifying the directive 1991/250/EEC of 14 May 1991), hereafter the "Computer Programs Directive".

<sup>491</sup> Directive 2006/115/EC of the European Parliament and of the Council of 12 December 2006 on rental right and lending right and on certain rights related to copyright in the field of intellectual property, OJ L 376/28, 27.12.2006 (codifying the Directive 92/100/EEC of 19 November 1992) hereafter the "Rental and Lending Directive".

<sup>492</sup> Directive 96/9/EC of 11 March 1996 on the legal protection of databases, OJ L 77/20, 27.03.1996, hereafter the "Database Directive".

<sup>493</sup> Directive 2001/29/EC of 22 May 2001 on the harmonisation of certain aspects of copyright and related rights in the information society, OJ L 167/10, 22.06.2001, hereafter the "Information Society Directive".

<sup>494</sup> B. HUGENHOLTZ, M. VAN EECCHOUD, S. VAN GOMPEL, L. GUIBAULT, N. HELBERGER, M. ROSSINI, L. STEIJGER, N. DUFFT and PH. BOHN, *The Recasting of Copyright & Related Rights for the Knowledge Economy*. 2006, p. 62.

<sup>495</sup> V.-L. BENABOU, "La directive "société de l'information" et l'acquis communautaire : une anamorphose ?", *Propr. intell.*, 2002, n° 2, p. 65.

<sup>496</sup> B. HUGENHOLTZ ET AL., *The Recasting of Copyright*, *op. cit.*, p. 74.

<sup>497</sup> B. HUGENHOLTZ, "Directive 96/9/EC on the legal protection of databases", in Th. Dreier and B. Hugenholtz (eds.), *Concise European Copyright Law*, Alphen aan den Rijn, Kluwer Law International, 2006, p. 325.

interpreted in two directions. Either the article 6(2) d) of the Database Directive is construed rather restrictively by meaning that it allows the application of exceptions already applied to databases prior to the adoption of the directive<sup>498</sup>. Or, and it should be in our view the preferred reading, national laws can, when transposing the directive in their national laws, expand the list of the exceptions of its article 6, to uses generally authorised under copyright<sup>499</sup>. The European Commission has however considered that the list of exceptions in the article 6(2) of the Database Directive is exhaustive<sup>500</sup>.

Under the second interpretation, the expansion of exceptions admissible for traditional copyrighted subject matter to databases is left to Member States and, in the cases already provided by the Database Directive, should not go beyond those specific exceptions. The list of exceptions contained in the article 5 of the InfoSoc Directive of 2001, or more exactly their implementation in national laws, will not automatically apply to databases<sup>501</sup>.

The situation of the exceptions to **related rights** and the articulation of the Rental and Lending Directive and the InfoSoc Directive is more intricate. The article 10 of the 1992 directive (codified in 2006) in its chapter on related rights, takes over the exceptions of the article 15 of the Rome Convention on neighbouring rights and allows Member States to provide for limitations in respect of private use, use of short excerpts for news reporting, ephemeral fixation by broadcasters, use for the purposes of teaching or scientific research. In its second paragraph, the article 10 authorizes Member States to provide for the same kinds of limitations known in copyright. The adoption of the Directive 2001/29 that covers exceptions both to copyright and related rights has not modified the earlier directive on related rights (except for the application of three-step test). Some overlap between the exceptions listed in the two directives, both applicable<sup>502</sup>, is thus possible. Some authors consider that the reproduction right having been deleted in the Rental and Lending Directive and replaced, for related rights, by the article 2 of the InfoSoc Directive, the exceptions to such rights are now only governed by the latter<sup>503</sup>. For sake of consistency, when the scope of one exception differs in the two applicable directives, the exception of the directive 2001/29 should prevail so as to avoid a different treatment of copyright and of related rights. We will see further on the example of the exception for teaching that seems more strictly defined in the Rental and Lending Directive. The best solution would however be to abrogate the exceptions contained in this latter directive to replace them by the common list of the InfoSoc Directive<sup>504</sup>.

---

<sup>498</sup> M. WALTER and S. VON LEWINSKI, *European Copyright Law, A commentary*, Oxford, Oxford University Press, 2010, p. 735-736, n° 9.6.35.

<sup>499</sup> B. HUGENHOLTZ ET AL, *The recasting of copyright...*, *op. cit.*, p. 73.

<sup>500</sup> Staff Working Paper on Copyright Review, on the Review of the EC legal framework in the field of copyright and related rights, 19 July 2004, SEC(2004) 995, p. 12. See S. BECHTOLD, "Information Society Directive", in Th. Dreier and B. Hugenholtz (ed.), *Concise European Copyright Law*, Alphen aan den Rijn, Kluwer Law International, 2006, p. 370.

<sup>501</sup> B. HUGENHOLTZ ET AL, *The recasting of copyright...*, *op. cit.*, p. 64.

<sup>502</sup> S. BECHTOLD, *op. cit.*, p. 370.

<sup>503</sup> M WALTER & S. VON LEWINSKI, *European Copyright Law, A commentary*, Oxford, Oxford University Press, 2010, p. 336-337, n°6.10.8.

<sup>504</sup> B. HUGENHOLTZ ET AL, *The recasting of copyright...*, *op. cit.*, p. 64.



## B. The exceptions in the InfoSoc Directive

The advent of the digital environment has justified that the exceptions be integrated in the efforts of harmonisation of the InfoSoc Directive. On one hand, some uses of copyrighted works authorized by exceptions are increasingly undertaken on the Internet, hence acquiring a cross-border dimension, which has justified the inclusion of exceptions in the topics requiring harmonization<sup>505</sup>. On the second hand, new digital uses of works begged the question of whether the exceptions were adapted to the information society. In that regard, two issues arose. First, the digital application of exceptions could cause increasing harm to copyright owners and emerging models of new exploitations and thus could justify new conditions or limitations to existing exceptions. Secondly, users have argued that they need to benefit from the possibilities offered by the information society to carry out expanded or new uses of works, which could raise the question of an extension or adaptation of exceptions. This second motive has been particularly addressed in legislative documents that followed the 2001 directive, such as the Communication on Copyright in the Knowledge Economy<sup>506</sup>. The balance achieved by the careful delineation of exclusive rights and exceptions is consequently in need of an on-going reassessment and readjustment, that could either reduce, limit or adapt the existing exceptions.

Exceptions are dealt with in the article 5 of the directive that enumerates cases where Member States are allowed to enact an exception to copyright and related rights. The list is exhaustive but optional, for Member States can decide not to implement all exceptions (but for the exception of temporary copying that is mandatory) but should refrain from introducing supplementary cases of authorized uses. The discretion left to Member States is not limited to the choice to implement or not an exception in their national copyright act. It also pertains to the conditions applicable to exceptions since the conditions of most exceptions laid down in the European text are not precisely determined, as will be seen when analyzing the exceptions concerned by the present study. As a consequence, the transposition of exceptions in the Member States is largely different, as the national lawmakers have implemented only the exceptions they deemed significant or adapted to their traditions and the conditions applicable to similar exception greatly vary from one country to another<sup>507</sup>.

Member States can adopt exceptions to the reproduction right (article 5(2)) or to both the reproduction and communication to the public rights (article 5(3)) depending on the use concerned. The article 5(4) of the directive also allows the national legislators to similarly apply exceptions, when needed to the right of distribution, without specifying the particular uses that would exempt the application of the distribution right.

A last and key element of the system of exceptions of the 2001 directive is its article 5(5) that inscribes the three-step test, already known in the Berne Convention and in TRIPS, within the *acquis communautaire*. Accordingly, exceptions and limitations shall only be applied in certain special cases that do not conflict with a normal exploitation of the work or other subject matter and do not unreasonably prejudice the legitimate interests of the rightholder.

---

<sup>505</sup> On the harmonisation of exceptions by the Information Society Directive, see L. GUIBAULT, G. WESTKAMP, T. RIEBER-MOHN, P.B. HUGENHOLTZ, *Study on the Implementation and Effect in Member States' Laws of Directive 2001/29/EC on the Harmonisation of Certain Aspects of Copyright and Related Rights in the Information Society*, report to the European Commission, DG Internal Market, February 2007, [www.ivir.nl/files/implementation\\_2001\\_29\\_EC/index\\_eng.html](http://www.ivir.nl/files/implementation_2001_29_EC/index_eng.html), p. 47.

<sup>506</sup> Communication from the Commission of 19 October 2009 – Copyright in the Knowledge Economy, COM(2009) 532 final.

<sup>507</sup> See the analysis of the Member States' laws in the first evaluation report on the directive 2001/29, G. WESTKAMP, *Study on the Implementation and Effect in Member States' Laws of Directive 2001/29/EC on the Harmonisation of Certain Aspects of Copyright and Related Rights in the Information Society. Part II. The Implementation of Directive 2001/29/CE in the Member States*, report to the European Commission, DG Internal Market, February 2007; B. LINDNER & T. SHAPIRO (eds.), *Copyright in the information society: a guide to national implementation of the European Directive*, Cheltenham, Edward Elgar, 2011.

### C. The objectives of the exceptions in the InfoSoc Directive

The directive 2001/29 participates to the European endeavour to create a general and flexible legal framework at Community level in order to foster the development of the information society in Europe<sup>508</sup>. To that end, the directive aims at harmonizing the principles and rules of copyright law that were deemed essential to the protection of works and creative content in the information society. An overall objective of the directive, as constantly reminded by the European Court of Justice<sup>509</sup>, is to increase legal certainty and provide for a high level of protection of intellectual property<sup>510</sup>.

In this general frame, copyright exceptions are adopted to strike a balance between the rights and interests of copyright holders and of the public at large<sup>511</sup>. Their specific objectives read as follows in the recitals of the directive 2001/29:

“This Directive should seek to promote learning and culture by protecting works and other subject-matter while permitting exceptions or limitations in the public interest for the purpose of education and teaching”<sup>512</sup>

“A fair balance of rights and interests between (...) the different categories of rightholders and users of protected subject-matter must be safeguarded. (...)”<sup>513</sup>.

However, this concern for the promotion of culture and the safeguard of public interest should not be achieved, as asserted by the Preamble of the Directive, “by sacrificing strict protection of rights or by tolerating illegal forms of distribution of counterfeited or pirated works”<sup>514</sup>, which again tilts the balance in favour of a high level of protection of copyright owners.

The cultural objectives of the exceptions are further repeated in subsequent documents of the European Union, namely in the Green Paper on *Copyright in the Knowledge Economy*:

“Wider dissemination of knowledge contributes to more inclusive and cohesive societies, fostering equality of opportunities in line with the priorities of the forthcoming renewed Social Agenda”<sup>515</sup>.

The directive 2012/28 of 25 October 2012 on certain permitted uses of orphan works also grounds the newly enacted exception for libraries, in the promotion of learning and the dissemination of culture<sup>516</sup>.

The contribution to the smooth functioning of the internal market and the development of the information society constitute other objectives of the directive 2001/29. To that end, recital 7 states that “those

<sup>508</sup> Recital 2 of the directive.

<sup>509</sup> C.J.E.U., judgment of 4 October 2011, C-403/08 and C-429/08, *Football Association Premier League and others*, paragraph 186; E.C.J., judgment of 16 July 2009, C-5/08, *Infopaq International*, ECR, 2009, I-6569, paragraph 40; C.J.E.U., judgment of 7 March 2013, C-607/11, *ITV Broadcasting and others*.

<sup>510</sup> As laid down in the recital 4 of the directive. See also the recital 9: “Any harmonisation of copyright and related rights must take as a basis a high level of protection, since such rights are crucial to intellectual creation”.

<sup>511</sup> As admitted by the C.J.E.U., judgment of 1 December 2011, C-145/10, *Painer*, paragraph 132.

<sup>512</sup> Recital 14.

<sup>513</sup> Recital 31.

<sup>514</sup> Recital 22.

<sup>515</sup> Green Paper – Copyright in the Knowledge Economy, COM(2008) 466/3, p. 4. See also the Communication from the Commission to the European Parliament, the Council, the European Economic and Social Committee and the Committee of the Regions of 20 November 2007 – A single market for 21st century Europe, COM(2007) 724 final (promoting the free movement of knowledge and innovation as the « fifth freedom » in the single market)

<sup>516</sup> See recital 1 and 2 of the Directive 2012/28/EU of the European Parliament and of the Council of 25 October 2012 on certain permitted uses of orphan works, OJ, L 299 of 27 October 2012.

national provisions on copyright and related rights which vary considerably from one Member State to another or which cause legal uncertainties hindering the smooth functioning of the internal market and the proper development of the information society in Europe should be adjusted, and inconsistent national responses to the technological developments should be avoided<sup>517</sup>. As far as exceptions are concerned, the harmonization objective is explained in recital 31:

“The existing exceptions and limitations to the rights as set out by the Member States have to be reassessed in the light of the new electronic environment. Existing differences in the exceptions and limitations to certain restricted acts have direct negative effects on the functioning of the internal market of copyright and related rights. Such differences could well become more pronounced in view of the further development of transborder exploitation of works and cross-border activities. In order to ensure the proper functioning of the internal market, such exceptions and limitations should be defined more harmoniously. The degree of their harmonization should be based on their impact on the smooth functioning of the internal market<sup>518</sup>.”

This limits the harmonization of the exceptions strictly to the differences that have an adverse effect on the functioning of the Internal Market. In other words, as stated in the first draft of the directive on copyright in the information society in 1997, “the degree of harmonization has been made dependent on their impact on the smooth functioning of the Internal Market, taking due account of the principle of subsidiarity and proportionality and of the new WIPO obligations. Those exceptions or limitations, which have a greater impact on the Internal market, have been made obligatory or the conditions of their application have been harmonized to a larger degree, where appropriate. Therefore, the degree of harmonization (...) reflects the balance between Internal Market needs (...) and the principle of subsidiarity<sup>519</sup>.”

---

<sup>517</sup> See also Recital 6.

<sup>518</sup> As specified by the Proposal for a European Parliament and Council Directive of 10 December 1997 on the harmonization of certain aspects of copyright and related rights in the Information Society, COM(97) 628 final, O.J.E.C., C 108 of 7 April 1998, p.28 : “such harmonization is indispensable for the smooth functioning of the Internal Market: without adequate harmonization of these exceptions, as well as their conditions of application, Member States might continue to apply a large number of rather different limitations and exceptions to these rights and, consequently, apply these rights in different forms”.

<sup>519</sup> Proposal for a European Parliament and Council Directive of 10 December 1997 on the harmonization of certain aspects of copyright and related rights in the Information Society, COM(97) 628 final, O.J.E.C., C 108 of 7 April 1998, p.28.

#### D. The interpretation of the exceptions by the CJEU

In the last three years, several cases involving the interpretation of copyright exceptions have been referred to the European Court of Justice that laid down several general principles to be applied to the interpretation of exceptions. There are more cases to come as preliminary questions have been recently referred to the Court about the parody exception<sup>520</sup>, the private copy<sup>521</sup> or the exception for on-site consultation<sup>522</sup>.

A key objective on which the Court has insisted is the attempt of the InfoSoc Directive to ensure consistency of the copyright rules and the functioning of the internal market. This overall objective of the directive should not, according to the EU judges, be distorted by Member States' different legislation, but should arrive at a coherent application of the exceptions and limitations<sup>523</sup>. The Court has repeatedly acknowledged the discretion left to Member States to implement the exceptions in their national laws<sup>524</sup>, as well as the modalities thereof when the provisions of the directive do not expressly specify them<sup>525</sup>. In the *Painer* case, the European judges have however stressed that such discretion must be exercised within the limits imposed by EU law<sup>526</sup>, and notably according to the following principles<sup>527</sup>:

- a principle of **proportionality**: accordingly, measures adopted by the Member States must be appropriate for attaining their objective and must not go beyond what is necessary to achieve it<sup>528</sup>;
- the compliance with the purpose of a **high level of protection** of copyright: The Member States cannot, by exercising this discretion, compromise the principal purpose of the directive 2001/29, i.e. the high level of protection of authors<sup>529</sup>;
- the need for **legal certainty**: the conditions of exceptions cannot be dependent of uncertain circumstances, such as a discretionary human intervention<sup>530</sup>.

In subsequent cases<sup>531</sup>, the CJEU has also said that transposing the directive "in an inconsistent and un-harmonised manner which may vary from one Member State to another, would be incompatible with the objective of that directive"<sup>532</sup>.

---

<sup>520</sup> Request for a preliminary ruling, 17 April 2013, C.J.E.U., C-201/13, *Deckmyn and Vrijheidsfonds*.

<sup>521</sup> Request for a preliminary ruling, 26 September 2012, C.J.E.U., C-435/12, *ACI Adam and others*.

<sup>522</sup> Request for a preliminary ruling, 14th March 2013, C.J.E.U., C-117/13, *Technische Universität Darmstadt*.

<sup>523</sup> C.J.E.U., judgment of 21 October 2010, C-467/08, *Padawan*, ECR, 2010, I-10055, paragraph 35 ("the recital 32 in the preamble (...) calls on the Member States to arrive at a coherent application of the exceptions to and limitations on reproduction rights, with the aim of ensuring a functioning internal market").

<sup>524</sup> C.J.E.U., judgment of 21 October 2010, C-467/08, *Padawan*, ECR, 2010, I-10055, paragraph 36; C.J.E.U., judgment of 1 December 2011, C-145/10, *Painer*, paragraph 104; C.J.E.U., judgment of 26 April 2012, C-510/10, *DR and TV2 Danmark*, paragraph 36.

<sup>525</sup> C.J.E.U., judgment of 1 December 2011, C-145/10, *Painer*, paragraph 103; C.J.E.U., judgment of 16 June 2011, C-462/09, *Stichting de ThuisKopie*, ECR, 2011, I-5331, paragraph 23.

<sup>526</sup> C.J.E.U., judgment of 1 December 2011, C-145/10, *Painer*, paragraph 104.

<sup>527</sup> See S. CARRE, *Le rôle de la Cour de Justice dans la construction du droit d'auteur de l'Union*, in C. GEIGER (ed.), *La contribution de la jurisprudence à la construction de la propriété intellectuelle en Europe*, Collection du CEIPI, LexisNexis, 2013, p. 38-40.

<sup>528</sup> *Ibidem*, paragraphs 105-106.

<sup>529</sup> *Ibidem*, paragraph 107.

<sup>530</sup> *Ibidem*, paragraph 108; see also E.C.J., judgment of 16 July 2009, C-5/08, *Infopaq International*, ECR, 2009, I-6569, paragraph 62.

<sup>531</sup> For more analysis, see V.-L. BENABOU, "Retour sur dix ans de jurisprudence de la Cour de justice de l'Union européenne en matière de propriété littéraire et artistique : les méthodes", *Propr. intell.*, n° 43, April 2012.

Still in *Painer*, the Court adds two other principles, the strict interpretation and the compliance with the three-step test, that are more rules applying to the exceptions themselves, rather than principles limiting the leeway enjoyed by Member States.

The **principle of strict interpretation** entails that provisions related to exceptions should be construed strictly as they derogate from the general principle of the directive, that of exclusive rights<sup>533</sup>. That being said, this principle has been attenuated to accommodate other considerations. First, the interpretation of the conditions of an exception must “enable the **effectiveness of the exception** thereby established to be safeguarded and **its purpose** to be observed”<sup>534</sup>. The rule has been further described in the *FAPL* case, as meaning that the exception must permit observance of the exception’s purpose and, as far as transient reproduction exemption is concerned, “must allow and ensure the development and operation of new technologies and safeguard a fair balance between the rights and interests of right holders, on the one hand, and of users of protected works who wish to avail themselves of those new technologies, on the other”<sup>535</sup>. The strict interpretation of exceptions is thereby opened up for a teleological approach that could mitigate a too narrow construction of the exception hindering its effectiveness in delivering what it is intended for in the directive 2001/29. When the exception aims at striking a fair balance between freedom of expression and the interest of the rightholder, it could go as far as making such freedom of the user prevail over some conditions normally required for the exception or refusing to add supplementary conditions to that prescribed by the directive<sup>536</sup>.

This is by far the most liberal approach that the European case law has adopted regarding the exceptions. If upheld<sup>537</sup>, it would mean that exceptions should not be literally construed or applied but should be seen as means to the end they pursue. Within due limits, their conditions or constraints could be reasonably interpreted when needed to apply to new situations and developments.

A last rule pertains to the application of the **three-step test** that could add further restrictions to the interpretation of the exception, whose conditions cannot be construed as harming the normal exploitation of the work or unreasonably prejudicing the legitimate interests of the rightholders<sup>538</sup>. Nevertheless, the Court has so far refrained from interpreting the criteria of the triple test and has considered, in two cases related to the temporary copying exception, that the compliance with the conditions of that exception suffices to satisfy the three-step test<sup>539</sup>.

---

<sup>532</sup> C.J.E.U., judgment of 21 October 2010, C-467/08, *Padawan*, ECR, 2010, I-10055, paragraph 36; C.J.E.U., judgment of 26 April 2012, C-510/10, *DR and TV2 Danmark*, paragraph 36.

<sup>533</sup> E.C.J., judgment of 16 July 2009, C-5/08, *Infopaq International*, ECR, 2009, I-6569, paragraphs 56-57; C.J.E.U., judgment of 1 December 2011, C-145/10, *Painer*, paragraph 109; C.J.E.U., judgment of 4 October 2011, C-403/08 and C-429/08, *Football Association Premier League and others*, paragraph 162.

<sup>534</sup> C.J.E.U., judgment of 1 December 2011, C-145/10, *Painer*, paragraph 133.

<sup>535</sup> C.J.E.U., judgment of 4 October 2011, C-403/08 and C-429/08, *Football Association Premier League and others*, paragraphs 163-164, related to the exception for temporary copying.

<sup>536</sup> C.J.E.U., judgment of 1 December 2011, C-145/10, *Painer*, paragraphs 134-136.

<sup>537</sup> The *Painer* decision could indeed be interpreted as applying only to the exception of quotation due to its strong relationship with the fundamental freedom of expression.

<sup>538</sup> E.C.J., judgment of 16 July 2009, C-5/08, *Infopaq International*, ECR, 2009, I-6569, paragraph 58; C.J.E.U., judgment of 1 December 2011, C-145/10, *Painer*, paragraph 110; C.J.E.U., judgment of 4 October 2011, C-403/08 and C-429/08, *Football Association Premier League and others*, paragraph 181.

<sup>539</sup> C.J.E.U., judgment of 4 October 2011, C-403/08 and C-429/08, *Football Association Premier League and others*, paragraph 181; C.J.E.U., order of 17 January 2012, C-302/10, *Infopaq International (Infopaq II)*, paragraph 56.

## E. Other principles applying to exceptions

### 1. Application of exceptions to unpublished works

A principle that is not touched upon by the *acquis communautaire* is whether the exceptions can concern works that have not been published or legally made available. This is a requirement that applies in a number of Member States. In some cases, the exclusion of the benefit of any exceptions applies in a general way and is laid down in an introductory provision to the lists of authorized uses (e.g. Belgium, France, Greece or Italy). In other legislation, the exclusion of unpublished works is a customary condition applied to exceptions or (e.g. Germany, Spain) or explicitly appears in the text of specific exceptions (e.g. Denmark, the Netherlands). The terminology also differs from “published works”, “lawfully published or made available”<sup>540</sup>, to “works that have been disclosed”.

There are different reasons justifying this exclusion. First it is generally understood, despite the reference to “publication”, that the exceptions are considered to be admissible only after the author has divulged her work<sup>541</sup>. The author of an unpublished work might have refrained from divulging the work for any reason, including the fact that it contains private information that was not intended for public access<sup>542</sup>.

The benefit of the exception is thus conditioned to the exercise by the author of her moral right of divulgation. This is explicit in the French *Code de la Propriété Intellectuelle* or the German law that relate the exceptions to the condition of the divulgation of the work. The Belgium Copyright Law refers to the lawful publication of work but this is interpreted as referring, as in France, to the moral right of divulgation<sup>543</sup>.

It could also be said that the condition of prior publication or making available aims at preserving the exploitation of the work by copyright owners before leaving some space for exceptions. By extension it raised the question of the lawful source that was primarily addressed in relation to the private copy<sup>544</sup>, with the notable purpose to exclude the application of private copying to acts of downloading from unlawful peer-to-peer file-sharing websites or software.

A supplementary ground lies in privacy concerns, which could occur when the work consists in private letters or photographs whose disclosure could prejudice the privacy of their author or of other persons.

It is unclear however as to whether this limitation of exceptions to published or lawfully made available works is a principle of *acquis communautaire*. The question of lawful source related to private copy has been recently referred to the Court of Justice of the European Union<sup>545</sup>. But, the moral right not being harmonized at the EU level, its relationship with exceptions is all the more uncertain. One could suggest that an exception could less easily pass the scrutiny of the three-step test if applied to an unpublished or undisclosed work, as it could (it would not be necessarily so though) harm the normal exploitation of the

---

<sup>540</sup> This second terminology is broader than the mere publication that could be interpreted in conformity with the notion of publication in the Berne Convention that only includes the making of copies and not acts of communication or making available.

<sup>541</sup> S. RICKETSON & J. GINSBURG, *International Copyright and Neighboring Rights. The Berne Convention and Beyond*, vol. I, 2<sup>nd</sup>, Oxford University Press, 2006, §10.37; A. LUCAS, H.-J. LUCAS & A. LUCAS-SCHLOETTER, *Traité de la propriété littéraire et artistique*, 4<sup>th</sup> ed., Paris, LexisNexis, 2012, p. 323, n°339.

<sup>542</sup> K. CREWS, *Study on Copyright Limitations and Exceptions for Libraries and Archives*, WIPO, August 2008, [www.wipo.int/meetings/en/doc\\_details.jsp?doc\\_id=109192/](http://www.wipo.int/meetings/en/doc_details.jsp?doc_id=109192/), p. 46.

<sup>543</sup> M.-Ch. JANSSENS, “Commentaar bij art. 21, 22, 22bis en 23bis Auteurswet”, in *La loi belge sur le droit d’auteur. Commentaire par article. Hommage à Jan Corbet*, 3<sup>e</sup> éd., Bruxelles, Larcier, 2012, p. 150.

<sup>544</sup> S. DUSOLLIER, “L’utilisation légitime de l’œuvre : un nouveau sésame pour le bénéfice des exceptions en droit d’auteur ?”, *Communications – Commerce Electronique*, Novembre 2005, p. 17-20.

<sup>545</sup> Request for a preliminary ruling, 26 September 2012, C.J.E.U., pending case, C-435/12, *ACI Adam and others*.

work that has not even taken place but could already be substituted by the use privileged by the exception, or prejudice the legitimate interest of the author to exercise his moral right of divulgation<sup>546</sup>.

The question was addressed during the adoption process of the Orphan Works Directive, some countries showing reluctance in the application of the orphan works definition and of its consequence, the authorized use for libraries and archives through a new exception, to unpublished works. As a significant part of unpublished works contained in museums or archives might be orphan, it would be problematic not to include them in the scope of the directive. The compromise that was found reads as follows in the article 1(3) of the directive 2012/28/UE:

“This Directive also applies to works and phonograms referred to in paragraph 2 which have never been published or broadcast but which have been made publicly accessible by the organisations referred to in paragraph 1 with the consent of the rightholders, provided that it is reasonable to assume that the rightholders would not oppose the uses referred to in Article 6. Member States may limit the application of this paragraph to works and phonograms which have been deposited with those organisations before 29 October 2014”.

The exception enabled by the directive would thus apply to unpublished or undissemated works, on the condition that the library, education establishment, museum or archive wishing to benefit from the exception, has made the work publicly accessible with the consent of rightholders and that those rightholders (not necessarily the same) would presumably not oppose to the making available now authorized by the directive.

Actually, this provision is rather obscure and would cover only very limited cases of unpublished works for a number of reasons. First, the directive is limited to some categories of works, such as books, journals, newspapers, magazines and other writings, or to cinematographic or audiovisual works and phonograms, that would generally be published, except for “other writings” or, in some cases, audiovisual works. The question of application of the directive to unpublished works will therefore only cover some writings and audiovisual works that have never been published or publicly released. The second limitation relates to the mention of rightholders that appears as somewhat incongruous when dealing with orphan works. The rightholder must have authorized the library or other eligible institution to make his work publicly available some time in the past. Then the work was not orphan but has become eventually, either because the rightholder can not be located anymore or is deceased and his heirs are unidentified or unfindable. One can think of an author having left unpublished materials (private letters, unpublished manuscripts, unfinished or private films ...) to a library, an archive or a museum, without excluding their making available to the public of the establishments and who (or whose heirs) would not refuse that such making available is extended on-line. The presumption of the valid consent of the current rightholder is left at the appreciation of the library, which can be difficult to apply. There is no mention neither to the legitimate reasons that could incline the library to think that such a consent would be lacking, such as privacy concerns or respect of the honor of the author. Finally, the author having authorized at some point the library to make some public use of his unpublished work, it could be inferred that the author has thereby exercised his right of divulgation.

For all this reasons, the question of undisclosed works, contained in the collection of a cultural heritage institution, might not be totally solved by this provision, as it would leave some unpublished material out of its scope.

In any case, the directive on orphan works, despite this article 1(3), does not give any indication as to the general rule of application of copyright exceptions to unpublished works. The issue is particularly relevant for libraries, museums and archives that deal with diverse materials, published or unpublished. Particularly, archives are prone to hold unpublished content in their collections. Many unpublished works can also be critical for research as they could illustrate or give key information on motives, context or biographical elements of cultural creation or enlightening historical information.

---

<sup>546</sup> See S. RICKETSON & J. GINSBURG, *op. cit.*, §13.29.

There seems to be no common understanding of this issue at the European level. Copyright scholarship only mentions the principle in relation to their domestic laws when it contains a rule excluding unpublished or undisclosed works from the exceptions.

## 2. Relationship of exceptions with licensing and market provision

The infoSoc Directive has refrained from declaring exceptions of an imperative nature, as the European lawmaker has sometimes done in earlier texts, such as the computer programs or database directives<sup>547</sup>. The question of whether the exceptions can be overridden by contract is thus left to Member States, some of them having opted for a prohibition to contract out of the exceptions<sup>548</sup>.

Without analysing the uneasy relationship between copyright exceptions and contract<sup>549</sup>, a more general perspective on the borders between the statutorily defined exception and the exercise of copyright by the rightholders should be addressed for the exceptions we will study. When the exception is not declared mandatory, it leaves some leeway for copyright and related rights owners to contractually prohibit the use, to license the use to the beneficiaries of the exception or to determine the conditions under which the use could take place. This possibility is sometimes included in the exception as spelled out by the directive, as we will see with the exception for on-site consultation.

Another issue is whether the exception could substitute the provision of works on the market. We will see that some Member States sometimes carve out works that are still available on the market or could be provided by the rightholders, from the scope of an exception. This gives some preference to the market and the exploitation of works by rightholders over the exception. The recent diversification of rules and situations in the European and national copyright lawmaking between out-of-commerce and commercially available works also indicates that the ambit of the authorised uses varies according to the economic reality of the work exploitation and is increasingly thought in gradual shades, from works not available in the market to works that are still exploited.

These different points convey the confrontation between the exceptions and the remaining exclusivity of copyright and related rights owners. It raises two related questions: 1) once the perimeter of an exception is drawn by law, is the rightholder still entitled to defeat the legal authorisation by contracting over the use with the beneficiary of the exception, and 2) should the exception only occupy the space where the market cannot provide the benefit of the use ?

The second question should be handled carefully. It could be read as a follow-up to the scrutiny by the three-step test that copyright exceptions should successfully pass, and notably the second step consisting in the absence of some harm to the normal exploitation of the work. This criteria of the normal exploitation should not however be construed as meaning that any market possibility would overcome the exception<sup>550</sup>. To define the criteria of 'normal exploitation', the WTO Panel decision on the three step test has referred to the ways right holders normally extract economic value from that right to the work (i.e., the copyright) and thereby deprive them of significant or tangible commercial gains<sup>551</sup>. It also points at the fact that the absence of a licensing system would not be determinant in deciding whether the use in question does not take part to the normal exploitation of the work<sup>552</sup>, but it cannot be inferred that the provision of a

---

<sup>547</sup> On that question, that will not be explored in details here, see B. HUGENHOLTZ, ET AL, *The Recasting of Copyright...*, *op. cit.*

<sup>548</sup> This is the case in Belgium, Portugal and Denmark.

<sup>549</sup> L. GUIBAULT, *Copyright Limitations and Contracts. An Analysis of the Contractual Overridability of Limitations on Copyright*, The Hague, Kluwer Law International, 2002.

<sup>550</sup> See the analysis by M. SENFTLEBEN, *Copyright Limitations and the three-step test*, Kluwer Law International, 2004, p.181 et seq.

<sup>551</sup> Report of the WTO Panel, *United States– Section 110 5) of the US Copyright Act*, 15 June 2000, WT/DS160/R, § 6.183.

<sup>552</sup> *ibidem*, § 6.188



license for a specific use would exclude the application of the exception<sup>553</sup>. This opinion is substantiated by the preparatory work of the Stockholm Conference that has introduced the three-step test into the Berne Convention. It mentions « all forms of exploiting a work, which have, or are likely to acquire, *considerable economic or practical importance* »<sup>554</sup>, this formulation being found also in the WTO Panel Report<sup>555</sup>. In our opinion, this indicates that the single possibility to provide the work to the user benefiting from the licence would not be enough in itself to consider that the exception counters the normal exploitation of the work. The scrutiny of the second step should rather look at the overall economic importance of the exploitation forms with which the exception would enter in economic competition.

It is only if the systematic use of the exception could divest authors from major sources of revenues that are significant within the overall commercialization of works, that it would contradict the normal exploitation of works. In our view, the fact that some works are commercially available is therefore not sufficient to include in the relevant exception a general exclusion of works that could be acquired through normal trade.

A reverse conclusion would mean that the exception is dictated by the functioning of the market and only answer to a market failure justification. Market failure has been regularly advanced, particularly in the writings of Chicago school of law and economics<sup>556</sup>, as a justification for exceptions. It could be defined as the principle according to which the exception would only be valid if the market is not capable, through provision of the work or licensing, to supply the demand of the user.

This justification, though it can apply to some exceptions, has now been rejected by the majority of scholarship that considers that exceptions are grounded on diverse reasons, which cannot be always solved by the market. The analysis of the market failure as a valid explanation of *fair use* in the United States has been particularly addressed by W. Gordon, who was regularly misunderstood in that regard<sup>557</sup>. In a later paper<sup>558</sup>, W. Gordon distinguishes two categories of justifications for *fair use*: the market failure or malfunction, when the market cannot license the use due to high transaction costs, and the market limitation when non-economic values prevent to rely solely on the market and on economics to enable the use, thereby justifying a rule of exception. The exception will fall in the second category if the exception pursues public interests that cannot be overcome by leaving the market decide on the use and the beneficiary of the exception should be transferred some control over the use<sup>559</sup>.

Both the European lawmaker and the international one refer to public interest as a key justification of copyright exceptions<sup>560</sup>. This motive should imply that the relationship between the existence of the exception and the market, but also between the condition of the exception and the market, should be tackled with due care.

---

<sup>553</sup> See S. DUSOLIER, *Droit d'auteur et protection des oeuvres dans l'univers numérique – Droits et exceptions à la lumière des dispositifs de verrouillage des œuvres*, Bruxelles, Larcier, 2005 n° 595 et suiv

<sup>554</sup> *Records of the Intellectual Property Conference of Stockholm*, Genève, OMPI, 1967, p. 112

<sup>555</sup> Report of the WTO Panel, *op. cit.*, § 6.180.

<sup>556</sup> W. LANDES & R. POSNER, "An Economic Analysis of Copyright Law", *Journal of Legal Studies*, 1989, Vol. XVIII, p. 357 et suiv.; W. GORDON, "Fair Use As Market Failure: A Structural And Economic Analysis of the Betamax Case and its Predecessors", *Colum. L. Rev.*, 1982, Vol. 82, p. 160; T. BELL, "Fair use v. fared use : the impact of automated rights managements on copyright's fair use doctrine", *N. C. L. Rev.*, 1998, Vol. 76, p. 558-618.

<sup>557</sup> W. GORDON, "Fair Use as a Market Failure...", *op. cit.*

<sup>558</sup> W. GORDON, "Excuse and Justification in the Law of Fair Use : Commodification and Market Perspectives", in N. NETANEL & N. ELKIN-KOREN (eds.), *The Commodification of Information*, The Hague/London/NewYork, Kluwer Law International, Information Law Series, n°11, 2002, p. 149-192.

<sup>559</sup> For a similar reasoning, see T. DREIER, "Musées, bibliothèques et archives : de la nécessité d'élargir les exceptions au droit d'auteur", *Propr. intell.*, 2012, n° 43, p. 190.

<sup>560</sup> See the Recitals of the Information Society Directive; Treaty to Facilitate Access to Published Works for Persons Who Are Blind, Visually Impaired, or Otherwise Print Disabled done in Marrakesh on the 27<sup>th</sup> of June 2013.

Therefore, a criterion of market substitution should not be the only guide to draw of the boundaries of an exception, even though the triple test includes the consideration of an adverse market effect. We will see the difference between those two approaches and its practical application to the different cases of exceptions surveyed by the present study.

## II. The exceptions benefiting to libraries

Libraries and other institutions, such as museums or archives, whose purpose is to maintain a collection of cultural artefacts and heritage, and to provide access thereto for research, education or private study, benefit from several exceptions in the *acquis communautaire*.

Those exceptions aim at ensuring some acts of preservation of the collections (art. 5(2) c) of the directive 2001/29), enabling consultation of some works on the premises of the establishment (art. 5 (3) n) of the directive 2001/29) and authorizing public lending by libraries (art. 6 of the directive 2006/115). To a different extent and in different ways, such exceptions limit copyright to accommodate key public-interest missions of the libraries, i.e. preservation and access to knowledge and culture. The digital evolution of libraries has significantly changed the possible impact of such exceptions, both on libraries' needs and expectations and on the legitimate protection of rights and interests of copyright and related rights holders. Libraries would like to benefit from the activities authorized by those directives to a similar or even broader extent in the digital environment, whereas the copyright owners fear that the digital extent of such uses would disrupt the balance established by the exceptions when they were adopted, excessively prejudice their rights and hamper the development of new services and business models in the online world.

This study aims at assessing the extent and relevance of those exceptions in the European copyright law and at considering whether adaptations to those exceptions are needed, particularly in the context of the digital environment. It will address successively the three exceptions, for certain acts of reproduction (B.), for on-site consultation (C.) and for public lending (D.).

As a preliminary introduction, the activities of libraries, archives and museums will be explained in order to better understand the context in which those establishments operate (A.)

## **A. Role and activities of libraries, archives and museums**

### **1. The changing role of libraries, archives and museums**

Libraries, archives and museums aim at collecting, storing, preserving and making available diverse cultural items. They are the custodians of cultural and scientific heritage and are entrusted to keep that heritage for future generations.

Part of their collections consists of works still protected by copyright. Therefore, when manipulating such works for the purpose of their public interest mission, they are likely to undertake acts of reproduction or communication to the public, which justifies that specific exceptions have been provided for by the InfoSoc Directive to accommodate some activities of libraries and similar cultural and scientific institutions.

The development of digital libraries in recent years has the potential to change the way works are accessed to, enjoyed and used. Libraries have traditionally been a repository for cultural artefacts produced by a society, a place to get access to such culture, do research and learn. Furthermore, a large part of works that are contained in the collection of a library or archive, including in a film heritage institution, might be unpublished, out of commerce or distribution, or consist in one of the rare copies available, which renders the task of safeguarding this heritage by libraries even more crucial.

Today, digitization of works could provide extended value to access to works, by maintaining the work in a quality that secures its future and frequent consultation, by adding search tools to the digitized items, by offering on-line lending that could seem equivalent for users to the acquisition of an e-book on the market. Digitization is also a privileged way to increase availability of collections and to envisage their dissemination on-line. The European Union has invested a lot in the Europeana project that would prompt all libraries and archives in the Member States to turn digital and offer works in their holding in a digital form. Audiovisual archives have also been developed by public broadcasters to digitize and preserve millions of hours of broadcasts that are a key testimony of history and culture of the 20<sup>th</sup> century.

The role of libraries has thus changed without changing. They continue to accomplish their basic mission of archiving, preserving and making available cultural and scientific documents and creations. However, libraries, archives and museums undergo dramatic changes in the digital environment and dream of an extended ambit to enhance accessibility of their collection that could challenge the models of exploitation by rights holders. Libraries used to be only limited competitors to the normal acquisition of works, as works could only be consulted on the site of the institution, through public lending limited in time and availability or, in limited cases, upon special request. By making works available on-line, libraries could become cultural entrepreneurs competing with copyright owners or provide to users a substitute to get access to works. To some extent, the lines between libraries activities and on-line commercial exploitation of works can be seen as blurring, except for the different motive that still distinguishes both activities. This renewed confrontation between the public interest of preserving knowledge and access thereto and the protection of copyright and related rights owners and of the normal market for works, entails some reassessment of the dividing line between the exclusive rights and the limitations in favour of libraries, archives and museums.

### **2. The activities of libraries**

Libraries and other cultural heritage institutions carry out a discrete series of activities that, at different degrees, further the preservation and dissemination of knowledge. Some already existed in the analogue environment, others are an offspring of the unfolding of the digital environment. They may involve only reproduction of some works or of whole collections or, combine reproduction and making available or even reproduction and distribution. Their effect on the normal exploitation of the work and the interests of the copyright owners might vary from inexistent to troublesome. The different uses of works presented

here might not intervene in all libraries or institutions with equal importance or at the same frequency and some establishments carry out some uses more often than others. The category of the institution concerned also matters. For instance a library may engage more in making works available to its patrons than an archive, in general open only to scholars and researchers, whereas the latter may invest more resources in restoration and preservation of works. Even in the same category, the institutions can greatly vary. For instance a university library will operate rather differently than a generalist public library: the former has generally less patrons than the latter, their users do more on-site research and consultation than they borrow books<sup>561</sup>. The libraries in charge of administering the legal deposit will also focus more on missions of preservation and access for research.

The type of works will be relevant too, as well as the tangible media in which they are embodied. Restoration of books will be less frequent and costly than the restoration of a film and it will concern mainly older books or often-consulted ones that are more likely to deteriorate. Conversely, movies of the first half of the 20<sup>th</sup> century were filmed on cellulose nitrate film, being very unstable, flammable and subject to rapid decomposition over time, as is its replacement technology, the acetate film, that suffers from decay. The role of film archives and museums is hence fundamental to preserve our audiovisual heritage. As to the difference of media, analogue copies are paradoxically less likely to become obsolete whereas digital copies require adequate equipment capable to read the format that evolves quickly over a short time.

Hence the difficulty to draw a common picture of the role of libraries, archives and museums, as it will greatly depend of their type, size, mandate, collections, the types of works and of media they hold. Nevertheless, the following activities can be proposed as an overall description of what libraries, archives and museums do with the content in their collection<sup>562</sup>:

#### **a) Activities related to setting up a collection**

A first activity of libraries and similar institutions will be to acquire works and content to constitute their collection. The major sources of acquisition will be found in buying, receiving through gifts or, for some institutions, through the obligation of a legal deposit. Generally such uses will not trigger copyright protection, as access to works by acquisition does not imply an act of reproduction, communication or distribution. However, as a consequence of the tremendous shift from printed to electronic information resources, new models of paying for access to these resources – monographs, articles, raw data – have largely replaced the traditional acquisition paradigm. This means that libraries do not have the ownership of those resources, which are made available for the patrons under the terms and conditions stipulated in the license agreements. Many acts of reproduction and communication can occur when downloading and installing the work in the library. They will generally be allowed by the license that will accompany the acquisition of the work.

Institutions in charge of legal deposit can undertake acts of copying content available on the web also called “web harvesting” to acquire digital content that the applicable law would subject to legal deposit for preservation of digital heritage. Such activity will imply acts of copying of copyrighted works.

Some libraries also reproduce copyrighted works when in charge of institutional repositories in universities and research institutions. Such repositories consist of collections of intellectual productions of their members, and particularly scholarly publications, research reports, theses and dissertations, or teaching materials. In a research environment that has to abide increasingly by open access standards and methodologies, the development of institutional repositories is an essential tool of the open access university policy. Many universities and research institutions have indeed adhered to the Berlin

---

<sup>561</sup> The distinction between generalist public libraries and academic and research ones will be further analysed below in the part about the public lending right.

<sup>562</sup> It should be noted that no assessment of the legality of the uses listed here is made at this stage.

Declaration on open access<sup>563</sup> and consequently, have mandated their libraries to implement the open access policy by collecting all research material produced by the researchers and making them available to all (or sometimes only to university members). Whereas the ultimate objective is to provide access to such materials within the institution or even outside thereof, the works will first have to be digitised (thus reproduced) to enter the repository.

## b) Activities of preservation

Libraries, archives and museums have a traditional role of preservation. This preservation of their collections or parts thereof varies in intensity, depending on the objective. All the uses developed below result in an act of reproduction, but their effect on the work and its exploitation will differ.

- **Restoration of damaged works:** When works are damaged or destroyed in part, libraries, archives and museums have to preserve them in the best way they can. Paper in books, photographs or films might decay or works may have been damaged by their readers. The act of preservation will require a reproduction of the missing part or a restoration of the damaged or decomposing element. The decision to restore a work will normally be taken individually for each work concerned.
- **Reproduction to preserve fragile works:** Cultural heritage institutions also have to care for works on an anticipative way to prevent them from being damaged or destroyed. It is the case for fragile and at risk works which need to be preserved before it becomes impossible to make any copy thereof. The vulnerability of the work will depend on the type of tangible embodiment and the frequency of its consultation. Such preventive restoration will require some partial reproduction or more often, will lead to digitize the whole work.
- **Reproduction for format shifting:** Finally, the institutions in question also need to be able to copy works for format-shifting purposes. If a format becomes obsolete or is no more usable because the technology to read or listen to works, does not exist anymore or is not easy to find or use<sup>564</sup>, they might decide to migrate all works existing in that format (analogue or even already digital) to a more recent one (generally digital). This format shifting will require reproduction and might occur on a regular basis, depending on the pace of obsolescence of the media concerned.
- **Mass-scale digitisation:** A more extensive activity of reproduction consists in mass-scale digitization where no specific objective (restoration, to counter the vulnerability or the risk of obsolescence of the media) will justify the digitisation, but the need or wish to enjoy the possibilities spurred by the digital technologies (making available on-line, easier preservation, research capabilities...). Mass digitization does not select the works to which it applies but concern the whole collection or a significant and determined part thereof (e.g. the collection of daily newspapers of a national library, the collection of engravings or photographs...). Consequently, search in the collection of a library can cover metadata, the inside text of the work or even link with other web services<sup>565</sup>. The intended outcome of such operation is normally the making available of that collection to the public for research and cultural objectives. It could also be to constitute a collection of items that is more easily searchable and indexed, upon the condition that the digitization has applied text-recognition tools (OCR or Optical Character Recognition software). Generally it will not encompass works that are already in a digital format but some transition to another digital format might be needed to integrate the born-digital work in

---

<sup>563</sup> Berlin Declaration on Open Access to Scientific Knowledge of 22 October 2003, <http://oa.mpg.de/lang/en-uk/berlin-prozess/berliner-erklarung/>.

<sup>564</sup> This is the case with films where some types of projectors to screen some audiovisual formats, if still existing, are rare or would further damage the film if used.

<sup>565</sup> M. BORGHI & S. KARAPAPA, *Copyright and Mass Digitization*, Oxford, Oxford University Press, 2013, p. 9.

the format chosen for the library's collection or to be compatible with the indexing and searching tools developed for the whole collection.

### c) Specific acts of reproduction

Additionally, libraries and archives may make specific acts of reproduction, such as:

- **Reproduction of a specific work upon request:** Libraries and archives often answer to requests from library patrons or researchers to get a copy of a specific work. Copying by the library itself can be justified by the fragility of some works that advises against letting the patrons manipulating the work themselves. Librarians might also make copies for some patrons such as professors or researchers in a university library or an archive for research purposes.
- **Reproduction by library patrons:** numerous acts of reproduction of works occur within the premises of the library and are made by patrons themselves. They will generally be authorised under the private copy or reprography exceptions.

### d) Acts of communication or making available

Beyond acts of reproduction, dissemination of culture to the public is a fundamental activity of libraries and other institutions. It is a mission of public interest to make available – upon certain conditions – works they own for the public, for the society. Making works available to the public of the library may take several forms, from the on-demand consultation of works on-site or on-line, to the online public lending:

- **Sending a copy of a specific work upon request:** libraries and archives sometimes send a copy of a specific work upon request, traditionally by mail and in a regular paper format. A digital equivalent of that act of supplying a copy is the scanning and sending the document by email to the patron requesting it.
- **Making available for on-site consultation within the library:** some parts of the collection of a library, museum or archive might be made available on computers or other equipments on the very premises of the establishment. The objectives pursued might vary greatly from an institution to another. Libraries will make available some works or databases whose access is often required (that frequency being a possible cause for damage to the works) or to facilitate the search within the document. Film archives will screen the movies they own in their screening rooms either upon request for research or in public screenings. Museums will offer for viewing some parts of their collections and archives might enable some consultation of works whose originals need to be preserved from too frequent manipulations. Extracts of works could also be shown on screens, as part of the exhibition of the museum's collection or in a public library, to promote some works to the visitors. Such on-site consultation will result in an act of making available to the public.
- **Making available of specific works or databases for remote consultation:** a functional equivalent of on-site consultation might consist in making some works available on request to researchers associated to the library (for instance in a university) or other members of the institution at distance. Benefiting from the digital networks, libraries extend the consultation off their walls to registered patrons who might be in their offices in the same or another building or even in a completely different location.
- **Making available for unrestricted on-line consultation or visit:** As a follow-up of mass digitisation, libraries can become digital on the model of Gallica (and of Europeana that is a portal leading to national digital libraries) and offer to an undifferentiated public the possibility to browse their collections. Other examples are projects of making archived broadcasts available on a dedicated website (as the INA in France or the SONUMA in Belgium). An equivalent can be found

in museums that offer a virtual visit of their collections on-line. The extent of the making available may range from limited viewing in low-quality to downloading of copies.

### e) Activities of lending

Public lending is one of the core activities of libraries, an activity which is not applicable to archives or museums (but for a use by another establishment). Other activities can be assimilated to lending, as they imply the transfer of a tangible copy of the work, even though they will not be considered as lending from a legal point of view.

- **Interlibrary loans:** libraries will transfer some works to each other to meet the requests of their patrons who might not find a specific work in one institution but request it from another. This is a regular and organised practised of libraries working in networks for that purpose.
- **Lending for an exhibition:** some originals or rare copies of works belonging to museum or archives, less often to libraries, might be requested by a museum or any other place to be included in an exhibition.
- **Public lending:** works can finally be lent to patrons for a limited time and for no lucrative purpose. Lending will happen in libraries (regardless of the type of content they own, whether books, music, films, ...), but normally not in archives or museums.

All the uses of works described hereinabove constitute a whole range of possibilities for library and other cultural heritage institutions. It does not mean that all of them imply an act covered by copyright nor that each of them should be authorized under an exception to copyright. Those uses are regularly carried out by libraries, museums and archives and will continue to be in the digital age. Some of them will increase in the knowledge economy, will occur in a different form or have a different impact.

This list of uses will help us determine their current status under the list of copyright exceptions laid down in directive 2001/29 and their possible entry to an adaptation of that list. They can be organised in a continuum that would distinguish acts of **preservation** of items of their collection and acts of **making available**. They range from selective acts of copying that deal with single items for specific reasons to more general reproduction of the whole collection. Likewise, making available can relate to a single item or expand to making works available from consultation within the premises of the establishment, consultation on-line with no possibility of printing or downloading to availability for downloading and e-lending. The continuum will serve as a basis for our analysis. The following table illustrates the gradual activities of preservation and making available undertaken by libraries, museums and archives.

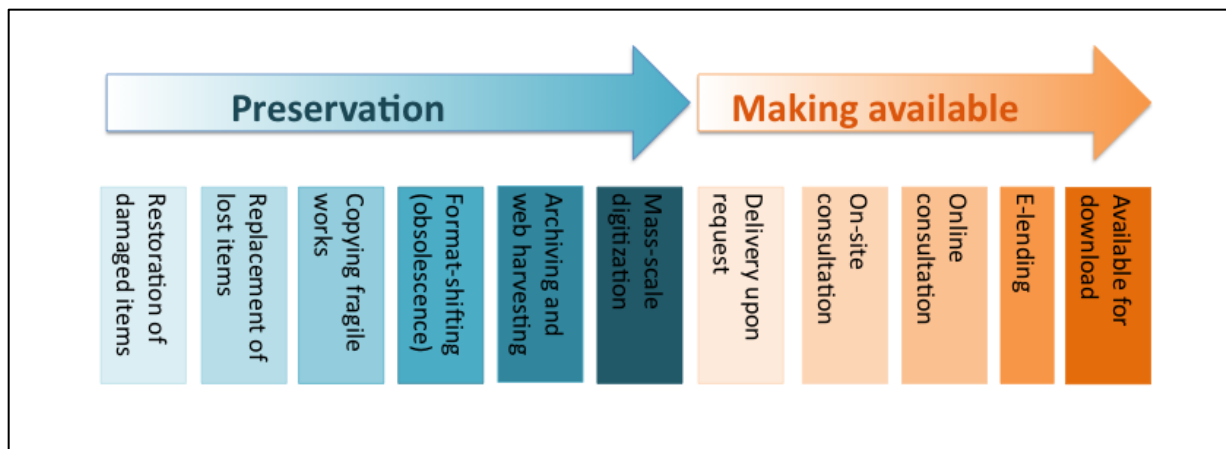

### 3. Intersection between libraries' activities and copyright exceptions

The exceptions of the *acquis communautaire* authorize some of the activities undertaken by the libraries, educational establishments, museums and archives to an extent that the present study will determine.

In a nutshell, some acts of reproduction, notably to preserve collections, are allowed under the article 5(2) c) of the InfoSoc Directive; the making available works on the premises of the institution is authorized by the article 5(3) n) of the same directive, whereas the public lending is addressed by the article 6 of Rental and Lending Directive. No other act of making available is exempted from the exclusive rights of the copyright owners.

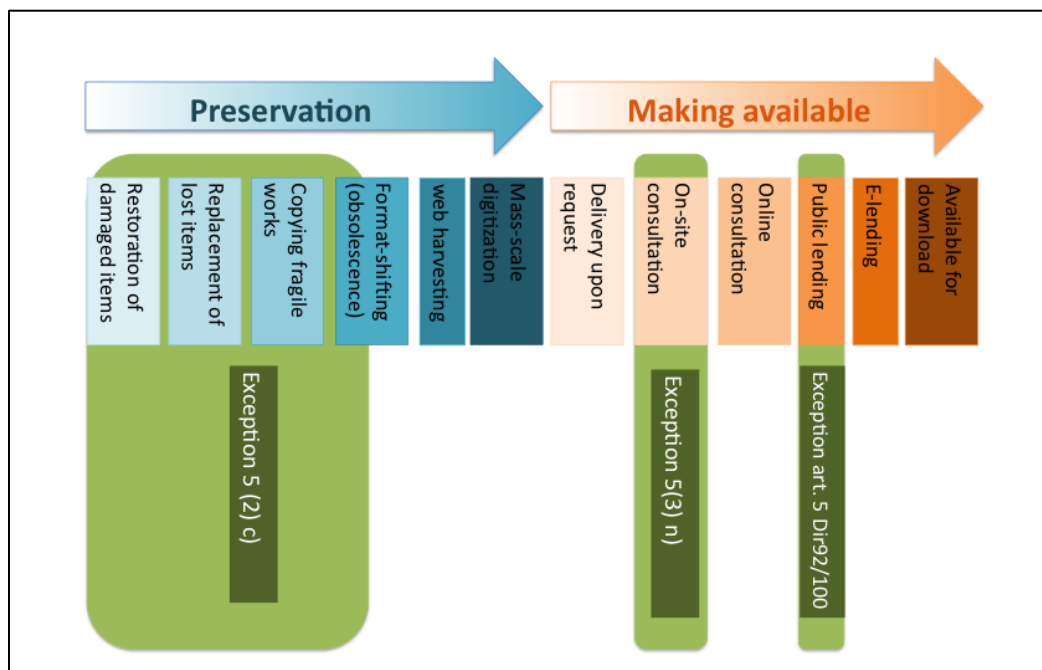

Those activities seemed rather separated. Yet, the advent of digital technologies, by blurring the distinction between reproduction and making available and by enlarging the possibilities offered to libraries, has created some overlaps between the scopes of each exception. The question of preservation now immediately brings about the possibility of making available the digitised collection. The possible loosening of the on-site consultation raises the issue of a broader act of making available. The lending of e-books, when occurring on-line, anchors itself to communication to the public. We will also see that under the exception for some acts of reproduction, some Member States allow the sending of copies of works by libraries to users upon request, which is an act of distribution when happening by traditional mail, and of making available when happening online.

In what follows, we will separate those three exceptions along the lines ascribed to each by the relevant legal provisions, but we will underline also the possible overlaps between the libraries' activities.



## B. The exception for certain acts of reproduction made by libraries

The article 5 (2) c) of the directive 2001/29 authorises Member States to provide for an exception or limitation “in respect of specific acts of reproduction made by publicly accessible libraries, educational establishments or museums, or by archives, which are not for direct or indirect economic or commercial advantage”.

This exception, as well as its implementation in Member States, will be analysed in order to<sup>566</sup>:

- examine whether major problems have emerged in Member States as a consequence of the implementation of this exception to the reproduction right;
- assess whether clarifications are needed as regards the type (analogue or digital) and number of copies that may be authorised and also whether the precise objective of the permitted acts of reproduction should be specified;
- assess whether other updates to this exception are needed to ensure the right balance between the interests of users of public establishments and rightholders.

First, the notion and scope of the reproduction exception for public libraries, educational establishments, museums or archives as provided for in the directive will be described (1.). Then the transposition thereof in the Member States will be reviewed so as to underline possible inconsistencies or difficulties (2.). Collective agreements, when existing, will be addressed as well (3.). Finally the issues possibly resulting from the exception itself or its implementation in national laws will be considered (4.) and some recommendations will be formulated (5.).

### 1. Scope of the exception in the directive

Article 5(2) c) of the directive 2001/29 pertaining to exception for libraries is broadly formulated and does not specify detailed requirements to benefit from the exception. Only the exempted exclusive rights, the beneficiaries and the limitation to non-commercial purposes are indicated. Therefore, the provision must be read in conjunction with the *travaux* (that do not say much more about the scope of the exception) and with the recital 40 that provides that:

“Member States may provide for an exception or limitation for the benefit of certain non-profit making establishments, such as publicly accessible libraries and equivalent institutions, as well as archives. However, this should be limited to certain special cases covered by the reproduction right. Such an exception or limitation should not cover uses made in the context of on-line delivery of protected works or other subject-matter. This Directive should be without prejudice to the Member States' option to derogate from the exclusive public lending right in accordance with Article 5 of Directive 1992/100/EEC. Therefore, specific contracts or licences should be promoted which, without creating imbalances, favour such establishments and the disseminative purposes they serve.”

The following criteria could help determine the scope of the exception: the objectives (a.), the beneficiaries (b.), the works concerned (c.), the authorised acts (d.), any further conditions imposed to the benefit of the exception (e.).

---

<sup>566</sup> We refer to the Annex A (Task Specifications, Study on the application of directive 2001/29/EC on copyright and related rights in the information society (the “Infosoc Directive”) of the Specific Contract: Markt/2012/013/D1/ST/SC implementing Framework Contract No PN/2009-35 D between the Commission of the European Communities and De Wolf & Partners.

## a) Objectives

The article 5 of the directive only refers to “specific acts of reproduction” without explaining further for what purposes those acts of reproduction are allowed. It is generally understood that the objective served by this provision is to enable libraries to copy works for preservation purposes, but the purpose is actually broader than strict preservation<sup>567</sup>, as revealed by the legislative history of the directive.

The report prepared by the European Parliament for the first reading of the directive mentioned the acts of reproduction made *for documentation or conservation purposes*<sup>568</sup>. It relied on the opinions of the different Committees of the Parliament that referred to the purpose of archiving and preservation<sup>569</sup> as being included in the authorized acts. This does not say whether other objectives could be comprised as well in the specific acts of reproduction. Conversely, the Committee on Culture, Youth, Education and the Media equated the specific acts to preservation and conservation<sup>570</sup>. The amended proposal sent by the Parliament to the Council specifically added the objective of *archiving or conservation purposes* within the text of article 5(2) c)<sup>571</sup> and further explained that “this paragraph (...) states that the acts of reproduction concerned may have only two purposes: archiving or conservation”.

This amendment was not however taken on board in the Common position that returned to a provision not defining the purposes to be pursued by the specific acts of reproduction<sup>572</sup>. In the Communication related to the common position, the Commission explained that the Council had preferred to limit the list of beneficiaries (the Parliament proposing an open list) but to allow for more flexibility as to the purpose of the acts of the reproduction that could go beyond archiving and preservation<sup>573</sup>.

This *va-et-vient* leaves two questions open. First, what is the meaning and scope of **preservation and archiving**, to which the Parliament wanted to restrict the exception? Nothing in the preparatory acts of the directive explains what they cover, or what is the difference between preservation and archiving.

Preservation/archiving can be understood more or less broadly. ‘To preserve’ is defined by the Oxford English Dictionary as ‘maintaining (something) in its original or existing state’, as well as ‘keeping safe from harm or injury’. It has both a conservative meaning and an pro-active one. It can cover strict acts of conservation aiming at keeping a work that would otherwise be lost and range from the restoration or replacement of a deteriorating or damaged copy, the reproduction of works on fragile media to more sustainable ones, to anticipative copying for format-shifting to counter foreseen obsolescence. “Archiving” could be understood as referring to copying to place or store in an archive or collection.

---

<sup>567</sup> M. WALTER & S. VON LEWINSKI, *op. cit.*, n° 11.5.39.

<sup>568</sup> Report on the Proposal for a European Parliament and Council Directive on the harmonization of certain aspects of copyright and related rights in the Information Society, COM (97) 0628 final – COD 97/0359, European Parliament, 28 January 1999..

<sup>569</sup> See the Opinions of the Committee on Economic and Monetary Affairs and Industrial Policy and of the Committee on the Environment, Public Health and Consumer Protection in the EP Report on the Draft Directive.

<sup>570</sup> In the EP Report, this could be inferred from the use of “i.e.” in the following sentence: in respect of specific acts of reproduction, i.e. preservation and conservation made in or by non-profit establishments”.

<sup>571</sup> Amended proposal for a European Parliament and Council Directive on the harmonisation of certain aspects of copyright and related rights in the Information Society, COM/99/0250 final - COD 97/0359, 21 May 1999.

<sup>572</sup> Common position adopted by the Council with a view to the adoption of a Directive of the European Parliament and of the Council on the harmonisation of certain aspects of copyright and related rights in the information society 09512/1/2000, 14 September 2000.

<sup>573</sup> Communication of the European Commission on the Common position, 20.10.2000, SEC(2000) 1734 final, p. 7 (“In its amendment 38, the European Parliament had proposed limiting Article 5(2)(c) (regarding libraries and similar establishments) to acts of reproduction for specific purposes only (archiving or conservation) but to allow for flexibility as regards the beneficiaries of the exception. This was adopted by the Commission in its amended proposal. However, in the common position, the Council opted for an exhaustive list of the beneficiaries (publicly accessible libraries, educational establishments, and museums as well as archives) and for more flexibility as regards the purposes of the acts of reproduction which may now also be for purposes other than archiving or conservation provided that there is no economic or commercial advantage”).

Migrating to another digital format can be encompassed in the notion of preservation if it is required against destruction or obsolescence. But, does it enable multiple and subsequent acts of digitization (once digitized in one format, another digitization in a more recent format would also meet the criteria of preservation); and can we still talk of preservation when format-shifting deals with born-digital works (the act of digitization is only a shift of digital format as the work has never existed in an analogue form).

A more fundamental question is whether the preservation purpose justifies projects of mass digitization, beyond works selected for reasons of damaged or fragile state, on the basis of a hypothetical risk to the preservation of the library or archive collection? It seems that mass digitization as such was not foreseen at the time of the adoption of the directive. To allow mass-digitization under the terminology of “preservation” would assume a more functional meaning to that term: it would cover activities that maintain the collection in a state that enables the key public-interest mission of the establishment concerned and notably the provision of access to works for research and private study. Having recourse to the notion of “archiving” that was also discussed in the process of adoption of the directive goes in the same direction. Under this conception, digitization, when necessary to keep up with the technological development, could be qualified as “archiving”.

Does the exception authorise the making of copies to be used for consultation purpose to prevent the original material to be damaged due to too frequent viewings and manipulations? Does it cover any kind of replacement copies or should the making of a copy of a damaged/lost work be limited if it still possible to acquire a similar copy on the market?

Actually, there is some ambiguity in the word “preservation”. Its main purpose is to preserve the object (the physical copy owned by the library) but indirectly the conservation of the artefact can help preserve the work itself (and therefore the cultural heritage), depending on the number of existing copies of the work. A good example concerns films whose only subsisting copy can belong to a film archive. Restoring the print would at the same time preserve the tangible copy and the audiovisual work itself that will be lost if its tangible embodiment falls in decay. In any case, the mission of a public library would be to preserve its collection, irrespectively of the fact that many copies thereof may exist elsewhere. But the question is whether this should be done under an exception or not.

A second question relates to the **other purposes** mentioned by the Commission when rejecting the amendment of the Parliament that would have restricted the exception to preservation or archiving. What could be such other purposes? If one refers to the list of acts regularly carried out by the libraries, elaborated in introduction of this report, not all of them strictly relate to a “preservation purpose”. One example is the reproduction of a work to reply to some request from users. But this purpose seems explicitly forbidden by the recital 40 of the directive that states that the exception “should not cover uses made in the context of on-line delivery of protected works or other subject-matter”, except if “on-line delivery” is interpreted strictly as only referring to making available to any users on-line, at the exclusion of acts of selectively sending some material to users<sup>574</sup>.

But what about the digitization of some works that are frequently browsed to enable their consultation in a digital format, less at risk of deterioration, and by many readers simultaneously? Strictly speaking, it does not serve a preservation purpose, but only indirectly. Is that the type of purpose that the Commission intended to cover beyond mere preservation?

We have seen that libraries undertake other acts of reproduction in relation to the setting up of a collection, particularly when they act in their obligation of legal deposit (archiving multimedia works, such as websites or video games) or for universities libraries, when they archive the scientific productions of their researchers in the institutional repository. Such acts can certainly be covered by the archiving purpose that was proposed by the European Parliament.

---

<sup>574</sup> Sending a copy by post would also require that the exception be explicitly extended to distribution right, as allowed by the article 5(4) of the directive.

In sum, few acts seem to be outside of the “preservation and archiving purpose”. In any case, the text of the exception, as it stands today is not restricted to those two objectives, which leaves open the definition of the acts of reproduction covered. Some national legislators, when transposing the directive, have somehow clarified the notion of “preservation”, as it will be seen below<sup>575</sup>, by indicating which “specific acts of reproduction” are concerned<sup>576</sup>.

## b) Beneficiaries

The beneficiaries of the exception are publicly accessible libraries, educational establishments, museums and archives. Recital 40 of the directive specifies that the exception only applies to non-profit making establishments such as publicly accessible libraries and equivalent institutions, as well as archives.

During the process of adoption of the directive, the European Parliament proposed an amendment to enlarge the list of beneficiaries, listing “libraries and archives and other teaching, educational or cultural establishments” only as examples of “establishments which are not for direct or indirect economic or commercial advantage” benefiting from the exception. The principle of a non-restrictive list has eventually been rejected by the Common position, which has been explained by the Commission as follows:

“the Council opted for an exhaustive list of the beneficiaries (publicly accessible libraries, educational establishments, and museums as well as archives) and for more flexibility as regards the purposes of the acts of reproduction which may now also be for purposes other than archiving or conservation provided that there is no economic or commercial advantage”<sup>577</sup>.

Libraries and archives are easy to define. Educational establishments referred to by the exception, encompass any institution offering education, such as schools, universities or establishments offering continued education for adults (upon the condition they are of a non-profit nature as we will see below).

Museums are also included in the list without being precisely defined. They will be generally understood as institutions offering public exhibitions of collections of objects, whether works of arts or not<sup>578</sup>. Beyond text-based works that museums can have in their collection as in libraries, acts of preservation might specially be relevant for recent works of art, using technology such as videos or even digital formats. Many artists have started to use video as a medium in the 60’s and those works begin to be unreadable and need to be digitized and format-shifted.

Film heritage institutions are eligible to the exception as they can be considered, depending on the context, as archives or even museums holding a collection of films.

Two conditions further qualify the establishments eligible to the exception.

First, they should be **accessible to the public**. The requirement to be “publicly accessible” only refers to libraries, educational establishments<sup>579</sup> and museums but not to archives, for the text of article 5(3) c), in most language versions, refers to “publicly accessible libraries, educational establishments or museums, or by archives”, archives being mentioned separately<sup>580</sup>. In other words, archives that are not publicly

---

<sup>575</sup> See also G. WESTKAMP, *op. cit.*, p. 22-25.

<sup>576</sup> Some advocate that the “specific acts of reproduction” must be “precisely described and also limited to certain special cases, see M. WALTER & S. VON LEWINSKI, *op. cit.*, n° 11.5.39.

<sup>577</sup> Communication of the European Commission on the Common position, 20.10.2000, SEC(2000) 1734 final, p. 7.

<sup>578</sup> J. AXHAMN & L. GUIBAULT, *Cross-border extended collective licensing: a solution to online dissemination of Europe’s cultural heritage?*, Final report for EuropeanaConnect, Amsterdam, 2011, [www.ivir.nl/staff/guibault.html](http://www.ivir.nl/staff/guibault.html), p. 14.

<sup>579</sup> According to S. BECHTOLD, *op. cit.*, p. 343, esp. 376, “Educational establishments” refer to schools, universities and institutions of adult education.

<sup>580</sup> J. AXHAMN & L. GUIBAULT, *op. cit.*, p. 15.

accessible can benefit from the exception<sup>581</sup>. Being publicly accessible to the public does not mean to have regular opening hours but requires that the access to these institutions is allowed “to the general public on a non-discriminatory basis”<sup>582</sup>. For instance a museum will be publicly accessible if it grants public access to its collection, even if some parts thereof might be stored in reserve and not be always accessible.

Second, the library, educational establishment, museum and archive need to be **non-profit making establishments**, as indicated by recital 40 of the directive. This is resumed in the text of the article 5(2) c) in the formulation of “which are not for direct or indirect economic or commercial advantage”, which can also be read as relating to the conditions of carrying out the acts of reproduction concerned that we will address in the next point.

This non-profit character does not mean to be free of charge or to be publicly funded or operated<sup>583</sup>. Therefore, private museums can benefit from the exception to the extent the conditions of the exception are satisfied<sup>584</sup>. A non-profit organisation such as the Internet Archive could equally be eligible, if it satisfies the other conditions of the exception. Charging a profit or fee exceeding the administrative or operation costs would be labelled as a direct commercial advantage<sup>585</sup>. Charged fees must not serve for “additional profit or to cover expenses of another institution or company”<sup>586</sup>.

Some difficulty in determining the non-profit nature of an establishment could arise when it results from a public-private partnership. S. von Lewinski and M. Walter gives the example of a private company running a library, that could yield some publicity or goodwill effect creating an indirect economic commercial advantage<sup>587</sup>. One further question is whether the library itself must carry out the acts of reproduction or can outsource them to another person, such as a private company. It does not seem to be excluded by the directive, but the exception should only benefit the acts of reproduction specifically done for the library and satisfying the requirements of the exception.

## c) Works concerned

### (i) General principle

Nothing in the directive or in its preparatory work indicates which types of works can be reproduced in the framework of this exception. As a principle therefore, all types of works can be reproduced by libraries and archives for preservation purposes.

The objective of the authorized reproduction being rather broad, discriminating between works is probably not necessary. However, the different notions of preservation that could be discussed could result in different treatment of some works, depending on their need to be preserved and their state of deterioration. Should the purpose of preservation be understood comprehensively and include digitization for format-shifting and preventive conservation, then all types of works could be concerned, even born-digital works, if there is a need to shift from the original digital format to a more recent one.

---

<sup>581</sup> S. BECHTOLD, *op. cit.*, p. 376.

<sup>582</sup> *Ibidem*, p. 377.

<sup>583</sup> *Ibidem*, p. 376. – See also the French Preparatory Works on the Law related to the *digital exploitation of unavailable books of the twentieth century: Draft bill on the digital exploitation of unavailable books of the twentieth century* (Proposition de loi relative à l'exploitation numérique des livres indisponibles du XXe siècle), Report n° 326, by Bariza KHIARI, on behalf of the Joint Committee, February 1st, 2012, Review of articles, [www.senat.fr/dossier-legislatif/ppl11-054.html](http://www.senat.fr/dossier-legislatif/ppl11-054.html), p. 12, P. BLOCHE (deputy) who explains that the concept of a publicly accessible library is broader than the one of public library, as it covers some private libraries.

<sup>584</sup> S. BECHTOLD, *op. cit.*, p. 343, esp. 377.

<sup>585</sup> M WALTER & S. VON LEWINSKI, *op. cit.*, n° 11.5.38.

<sup>586</sup> S. BECHTOLD, *op. cit.*, p. 377, (which excludes, according to S. Bechtold, “company libraries and archives”)

<sup>587</sup> M WALTER & S. VON LEWINSKI, *op. cit.*, n° 11.5.38.

### **(ii) Unpublished works**

The case of unpublished works is not addressed in the directive. Some Member States only apply exceptions to published or disclosed works as a matter of principle, notably to preserve the moral rights of divulgation of the authors. We have seen earlier that the *acquis communautaire* does not say anything as to the applicability of exceptions and limitations to unpublished or undisclosed works. Hence, as far as copying for preservation is concerned, it can also pertain to unpublished works if not prohibited by the domestic law<sup>588</sup>. The question is particularly significant for archives and museums that could hold in their collections some unpublished papers, manuscripts, pictures or other types of works, the historical, cultural or scientific interest could be significant and merit similar efforts of preservation than published material. The issue of unpublished works will be more relevant when further acts of communication (which is normally not the case under that exception) will occur, as it will trigger issues of moral right of divulgation.

### **(iii) Computer programs and databases**

On the ground that the directive 2001/29 is without prejudice of exceptions applicable to specific subject matter governed by other directives, databases and software appear to be excluded from the scope of the exception for preservation. The effect on software might be minimal as there will be few libraries or archives collecting and preserving software. However, museums of videogames are developing and seek to archive old games. To the extent that videogames are deemed to be computer programs, no exception for preservation will apply and the specific exception for back-up copying does not fit with a preservation purpose. Following the *BSA* decision of the Court of Justice that has considered that the graphic user interface was a work subject to the general rules of the InfoSoc Directive 2001/29 and not to the *lex specialis* of the directive 2009/24 on the legal protection of computer programs<sup>589</sup>, specific acts of reproduction for preservation of the video game could be exempted by virtue of the article 5(2) c) of the former directive<sup>590</sup>. The Court of Justice could soon elaborate further this distributive application of the two directives to computer programs, as one pending case concerns the application of technological measures of protection (and incidentally of exceptions) to video games<sup>591</sup>. The Advocate General, in her conclusions in that case<sup>592</sup>, has held that:

“Directive 2009/24 concerns only computer programs, whereas Directive 2001/29 concerns copyright and related rights in intellectual works in general. The latter leaves intact and in no way affects existing EU provisions relating to, inter alia, the legal protection of computer programs. The Court has thus stated that Directive 2009/24 constitutes a *lex specialis* in relation to the provisions of Directive 2001/29. In my view, that statement must be read as meaning that the provisions of Directive 2009/24 take precedence over those of Directive 2001/29, but only where the protected material falls entirely within the scope of the former. (...) Where complex intellectual works comprising both computer programs and other material are concerned – and where the two cannot be separated – it seems to me that the greater, and not the lesser, protection should be accorded. If that were not so, rightholders would not receive in respect of that other material the degree of protection to which they are entitled under Directive 2001/29”.

This opinion is in favour of applying the two directives cumulatively to complex creations, such as video games, that mix the characteristics of computer programs and other types of works, in order to grant them the greater protection. Could it be construed as not applying the exceptions of the InfoSoc Directive to

<sup>588</sup> Some countries have sometimes reserved a special treatment to unpublished works in their preservation exception, as in UK (see below).

<sup>589</sup> C.J.E.U., judgment of 22 December 2010, C- 393/09, *Bezpečnostní softwarová asociace* (BSA), ECR, 2010, I-13971.

<sup>590</sup> This distributive protection, following the *BSA* decision, raises intricate issue as to the overlap of exceptions. If the graphic user interface could benefit from the exception for preservation purpose, the source code of the program will not and in theory, the owner of the copyright in the software could prohibit the reproduction for that purpose.

<sup>591</sup> Question referred for a preliminary ruling by the Tribunale di Milano, C-355/12, *Nintendo*.

<sup>592</sup> Opinion of the Advocate General Sharpston, delivered on the 19th September 2013, C-355/12, *Nintendo*.

video games in order to maintain a higher protection of copyright owners? This question is not referred to the Court and the Advocate General does not elaborate on that point. Maybe the decision to come in that case will shed some light on the intricate hybridation of the two directives when applied to complex works such as videogames.

As to databases, no specific exception from copyright or *sui generis* right to the benefit of libraries, museums and archives is provided for in the directive 96/9 on the legal protection of the database<sup>593</sup>. However, the article 6(2) d) of that directive allows the Member States to provide for a similar exception to those traditionally authorized under national law. The exact meaning of that provision is disputed<sup>594</sup>, as discussed above, but it could be understood as allowing the application of an exception known in copyright law to the particular subject-matter of database. It shall thus be a matter for national legislators to authorize the preservation of databases similarly to the exception applicable to other copyrighted works, at least for copyright protection of the database. No exception would be applicable to the *sui generis* right, despite the fact that the preservation of a database certainly amounts to an act of extraction of a substantial part of the database.

#### **(iv) Works still available on the market**

The article 5(2) c) does not mention anything regarding the possibility to acquire a work on the market in order to replace a damaged or deteriorating work. We will see that some Member States exclude in such a case the benefit of the exception.

#### **d) Authorised acts**

The exception only exempts specific acts of **reproduction**, which leaves untouched the exclusive rights of communication. By virtue of the article 5(4) of the directive, the exception can also be extended to necessary acts of distribution “to the extent justified by the purpose of the authorised act of reproduction”. Additionally, the directive, by its recital 40, clearly excludes on-line delivery of works. Therefore, reproduction of works made under the exception cannot result in dissemination or making available of works<sup>595</sup>.

The acts of reproduction carried out by libraries and other eligible establishments must be “**specific**” which is not further defined in the directive. It should be read in conjunction with the purpose allowed for the reproduction, including preservation and archiving. In any case, it does not provide the concerned establishments with a blanket exception for any type of reproduction and for their whole collection or catalogue<sup>596</sup>.

“Specific acts of reproduction” could be understood either as referring to strictly defined acts or to acts limited in volume. S. von Lewinski and M. Walter affirm that further conditions must be described by national laws<sup>597</sup> and refer to the compliance with the “special cases” requirement in the three-step test<sup>598</sup>, which finds also support in the recital 40 of the directive that holds that the permitted acts “should be limited to special cases covered by the reproduction right”. Coupled with the rule of strict interpretation of exception, it suggests that mass-digitization of a whole collection or catalogue is not authorized by the

---

<sup>593</sup> *Study on the Implementation of Directive 2001/29/EC ... op. cit.*, p. 47.

<sup>594</sup> B. HUGENHOLTZ ET AL, *The recasting of Copyright*, *op. cit.*, p.62. The Commission considers the list of exceptions in the database directive as being exhaustive, see Staff Working Paper on Copyright Review 2004, p. 7.

<sup>595</sup> Except if authorized on the basis of another exception such as the on-site consultation of article 5(3) n).

<sup>596</sup> Green Paper from the Commission on Copyright in the Knowledge Economy, COM(2008) 466, p. 8.

<sup>597</sup> M WALTER & S. VON LEWINSKI, *op. cit.*, n° 11.5.39.

<sup>598</sup> *Ibidem*.

exception. Most commentators are of the opinion that the exception would not cover bulk copying of cultural institutions collections<sup>599</sup>.

Another question relates to the admissibility of making several copies notably because of the obsolescence of digital formats. In order to guarantee the preservation of works in different formats, multiple copies will be necessary and this seems not contrary to the wording of the directive<sup>600</sup>. In any case, the acts of reproduction in question must be strictly necessary for the purpose pursued by the library<sup>601</sup>. Copies should be incidental to the act of preservation.

The specific acts must not be “**for direct or indirect economic or commercial advantage**”. In the text of article 5(2) c, this factor can be understood as referring both to the eligible beneficiaries and to the nature of the authorized acts. This condition was borrowed from the directive on rental and lending rights<sup>602</sup> in which this criterion serves as the distinguishing factor between rental and lending (thus pertaining to the act and not the institution).

An act not carried out for direct or indirect economic or commercial advantage is defined in that directive as not giving rise “to a payment the amount of which does not go beyond what is necessary to cover the operating costs of the establishment”<sup>603</sup>.

Beyond the analysis of this criterion as determining the non-profit nature of the eligible institutions, the application of the absence of any commercial advantage to the acts of preservation sounds rather rhetorical as it is difficult to envisage what advantage a mere act of copying to preserve an item of the collection of a library or museum could yield on its own. Generally the possible economic advantage would result from the exploitation and communication to the public of that copy<sup>604</sup>, which are acts not allowed under this exception, and not to the mere preservation. On the contrary, the fee possibly charged by the institution could influence, if excessive, the not-for-profit nature of the eligible establishment.

### e) Further conditions

The directive does not impose any further conditions, for example as to the number of copies or their format.

The exception for the benefit of libraries and similar establishments does not provide for a fair compensation to be paid to rightholders. That does not prevent Member States to apply some scheme of compensation, as the recital 36 of the directive allows such possibility for any exception. Recital 35 lays down some principles to determine the form and level of such fair compensation and insists on the criterion of the harm caused to the rightholders. When the harm is minimal, it could even lead to no payment. In cases of reproduction for preservation by libraries and archives (without any communication or consultation), one can wonder what would be the level of the harm suffered by the copyright owners.

<sup>599</sup> J. AXHAMN & L. GUIBAULT, *op. cit.*, p. 17; HIGH LEVEL EXPERT GROUP ON DIGITAL LIBRARIES, *Digital Libraries: Recommendations and Challenges for the Future*, i2010 Digital Libraries Initiative. Final report, 2009, [http://ec.europa.eu/information\\_society/activities/digital\\_libraries/doc/hleg/reports/hlg\\_final\\_report09.pdf](http://ec.europa.eu/information_society/activities/digital_libraries/doc/hleg/reports/hlg_final_report09.pdf), p. 7.

<sup>600</sup> CH. GEIGER, F. MACREZ, A. BOUVEL, S. CARRE, TH. HASSLER and J. SCHMIDT, “Quelles limites au droit d’auteur dans la société de l’information ? Réponse au Livre vert sur “le droit d’auteur dans l’économie de la connaissance”, *Propr. intell.*, 2009, n° 32, p. 231, esp. p. 235.

<sup>601</sup> P. TORREMANS, “Archiving exceptions : where are we and where do we need to go ?”, in E. Derclaye (ed.), *Copyright and Cultural Heritage, Preservation and access to works in a digital world*, Cheltenham, Edward Elgar, 2010, p. 111, n° 4.2 ; CH. GEIGER ET AL., *op. cit.*, p. 231, esp. p. 235.

<sup>602</sup> Directive 2006/115/EC of the European Parliament and of the Council of 12 December 2006 on rental and lending right and on certain rights Related to copyright in the field of intellectual property (codified version), *OJ*, L 376 of 27 December 2006, p. 8.

<sup>603</sup> Recital 11 of the Rental and Lending Directive.

<sup>604</sup> For example, the institutions must not market the copies they made or use them for advertising (M. BUYDENS, “La nouvelle directive du 22 mai 2001 sur l’harmonisation de certains aspects du droit d’auteur et des droits voisins dans la société de l’information : le régime des exceptions”, *A.M.*, 2001, n° 4, p. 429, n° 17).



## 2. Implementation of the exception in the Member States

Although optional, the exception of the article 5(2) c) has been transposed in all the Member States that are analyzed by the present study<sup>605</sup>. However, many disparities have resulted from national implementations and from the ample discretion that the provision of the directive leaves to Member States. Particularly, Member States have been generally more detailed in the requirements imposed on the conditions and in many cases, more restrictive than the directive.

### a) Objectives

Member States have generally restricted the purposes of the exception, left open in article 5(2) c) of the directive, to preservation or equivalent notions. The Belgian Copyright Law mentions the general purpose of preservation<sup>606</sup>, as in Denmark<sup>607</sup>, Luxemburg<sup>608</sup> and France<sup>609</sup>, whereas Hungary<sup>610</sup> refers to archiving, Spain to conservation<sup>611</sup> and Poland<sup>612</sup> to maintaining and protecting collections.

Some national laws have even restricted the notion of preservation to more limited specific cases or have recourse to terminology that seems to aim mostly at restoring or replacing a damaged or deteriorated item. For instance, the UK limits the acts carried out by libraries to the purpose of replacement (even though its article 42 embraces two purposes, “to preserve or replace”)<sup>613</sup>. The Danish law includes the possibility to make copies of missing parts of a work<sup>614</sup>. The Netherlands restricts the reproduction made by libraries and other similar establishments to the sole purpose of restoration of the specimen of the work and the retention of a reproduction of the work if the specimen is threatening to fall into disrepair<sup>615</sup>.

Germany is a special case as the directive has not been transposed in that regard, the lawmaker having considered that the existing exception authorizing copying for “inclusion in a personal archive”<sup>616</sup> and “for other personal use” already covered acts of reproduction made by libraries<sup>617</sup>. The terminology used limits the purpose to the internal use of the library. Another exempted purpose is the delivery of copies of works

---

<sup>605</sup> For an analysis of the transpositions in all the Member States, see G. WESTKAMP, *op. cit.*; B. LINDNER & T. SHAPIRO (ed.), *op. cit.*

<sup>606</sup> Article 22, §1, 8° of the Belgian Law of 30 June 1994 related to Copyright and Neighbouring Rights, *M.B.*, 27 July 1994, p. 19297.

<sup>607</sup> Article 16 of the Danish Consolidated Act No. 202 of 27 February 2010 on Copyright. See K. CREWS, *Study on Copyright Limitations and Exceptions for Libraries and Archives*, *op. cit.*, p. 53.

<sup>608</sup> Article 10, 10° of the Luxemburg Law of 18 April 2001 on Copyrights, Neighbouring Rights and Databases.

<sup>609</sup> Article L-122, subparagraph 1, 8° of the French Intellectual Property Code of 1 July 1992.

<sup>610</sup> Article 35, (4) of the Hungarian Act LXXVI of 22 June 1999 on Copyright.

<sup>611</sup> Article 37, (1) of the Spanish Consolidated Text of 1 April 1996 on Intellectual Property.

<sup>612</sup> Article 28, (2) of the Polish Law No. 83 of 4 February 1994 on Copyright and Neighboring Rights.

<sup>613</sup> Article 42 of the British Copyright, Designs and Patents Act of 15 November 1988. See also article 38 (Copying by librarians: articles in periodicals), 39 (Copying by librarians: parts of published works), 41 (Copying by librarians: supply of copies to other libraries), 43 (Copying by librarians or archivists: certain unpublished works), 44 (Copy of work required to be made as condition of export) and 44A (Legal deposit libraries).

<sup>614</sup> Article 16 of the Danish Consolidated Act No. 202 of 27 February 2010 on Copyright. See K. CREWS, *Study on Copyright Limitations and Exceptions for Libraries and Archives*, *op. cit.*, p. 53: “The Danish law includes the concept of “completion” under which, as described in Finnish law, “the library may make copies of a work for the specific purpose of either completing a work or filling in a missing part of a work that is published in multiple parts. Examples of completion might include the making of portions of a book to replace missing pages, or making a copy of a book or other work that is one volume in a set, such as one volume from an encyclopedia”.

<sup>615</sup> Article 16n of the Dutch Law containing New Regulation of Copyright of 23 September 1912 (Dutch Auteurswet 1912).

<sup>616</sup> Article 53, (2), subparagraph 1, point 2, with subparagraph, 2, point 3, of the German Act of 9 September 1965 on Copyright and Related Rights.

<sup>617</sup> Personal use is broader than “private use” that covers private copying.

upon individual request<sup>618</sup>, which clearly exceeds a preservation purpose and involves a limitation to the right of distribution.

On the contrary, some countries use a broader terminology that appears to cover less restrictive acts of copying, going even beyond strict preservation purposes. The most extensive example is Italy<sup>619</sup> that formulates the exception “for the services of the institution” (but the exception is limited on several other accounts). Hungary<sup>620</sup> adds the purpose of scientific research and public library supply, as well for the internal purposes of the entity (but only for extracts of works).

As a result of a mix of the exceptions for on-site consultation and for reproduction, France<sup>621</sup> allows the reproduction and the performance of works, to the extent it aims at preserving the conditions of consultation for purposes of research or private study. This is also the case in Hungary<sup>622</sup> and Luxemburg. France further authorizes the institutions in charge of legal deposit to make copies if necessary for the collection of works<sup>623</sup>.

The Netherlands is the only country that deals with format-shifting by mentioning the purpose of “keeping the work in a condition in which it can be consulted if there is no technology available to render it accessible”<sup>624</sup>. That does not mean however that format-shifting could not be allowed in other countries in the more general purpose of “preservation”<sup>625</sup>.

Finally Denmark<sup>626</sup> “[h]as a [...] statute governing the making of digital copies for library users. It permits digital copies of articles and other works, but subject to an extended collective license and the right of the owner to demand remuneration”.<sup>627</sup> According to the British Copyright Act, librarians and archivists can similarly make and supply a copy of a work upon request of a user for research and private study, as well supply it to other libraries<sup>628</sup>.

## b) Beneficiaries

### (i) Types of Institutions

All Member States comply with the exhaustive list of beneficiaries appearing in the directive (comprising only libraries, educational establishments, museums and archives) but are sometimes more restrictive.

**Libraries** and **archives** are covered in all the legislations analysed for the present study. Libraries are precisely defined in Polish Law<sup>629</sup>.

<sup>618</sup> Article 53a of the German Act of 9 September 1965 on Copyright and Related Rights.

<sup>619</sup> Article 68, (2) and 69, (2) of the Italian Law No. 633 of 22 April 1941 for the Protection of the Copyright and the Other Related Rights to its Exercise.

<sup>620</sup> Article 35, (4) of the Hungarian Act LXXVI of 22 June 1999 on Copyright.

<sup>621</sup> Article L-122, subparagraph 1, 8° of the French Intellectual Property Code of 1 July 1992, which has included performance of works since the statute n° 2009-669 of 12<sup>th</sup> June 2009 (HADOPI I).

<sup>622</sup> Article 35, (4) of the Hungarian Act LXXVI of 22 June 1999 on Copyright.

<sup>623</sup> Article L-131-1 and seq. of the French Heritage Code.

<sup>624</sup> Article 16n of the Dutch Auteurswet of 23 September 1912.

<sup>625</sup> Format-shifting is not allowed in the UK. See W. CORNISH, B. LLEWELYN and T. APLIN, *Intellectual property: Patents, Copyright, Trademarks and Allied Rights*, 7<sup>th</sup> ed., London, Sweet and Maxwell, 2010, §12-49.

<sup>626</sup> Article 16b of the Danish Consolidated Act No. 202 of 27 February 2010 on Copyright.

<sup>627</sup> K. CREWS, *Study on Copyright Limitations and Exceptions for Libraries and Archives*, *op. cit.*, p. 36.

<sup>628</sup> Articles 38-41 of the British Copyright, Designs and Patents Act of 15 November 1988.

<sup>629</sup> See article 4 of the Polish Act of 27 June 1997 on Libraries :

Hungary specifically include pictures and audio archives, whereas Spain includes record, films and newspapers archives.

**Museums** are not mentioned in Germany, Poland and the UK<sup>630</sup>. The current draft to review copyright exceptions in the UK plans to include museums and galleries in the list of the institutions eligible to the exception for preservation purposes<sup>631</sup>.

**Educational establishments** are often not listed in the beneficiaries: only Luxemburg<sup>632</sup>, Hungary<sup>633</sup> and Poland<sup>634</sup> grant the exception to educational establishments<sup>635</sup>, but their libraries or archives are covered in Italy<sup>636</sup> (school libraries), Belgium<sup>637</sup> and Spain<sup>638</sup>. This reveals a rather functionalist approach of the establishments covered instead of a structuralist one: this is the function of library and archives that is eligible to the exception not the institution in which this library is hosted or operated.

Again a specific case is Germany that does not precise the beneficiary of the exception allowing copying for scientific use or inclusion in a personal archive, but requires that it is done by an archive acting in the public interest<sup>639</sup>.

### (ii) *Functional requirements*

The requirement according to which the beneficiaries of the exception (but the archives) being **publicly accessible** has been taken from the directive but sometimes applied randomly.

Only libraries have to be publicly accessible in Belgium<sup>640</sup>, France<sup>641</sup>, and Luxemburg<sup>642</sup>. The Netherlands<sup>643</sup>, Hungary<sup>644</sup> and Italy<sup>645</sup> apply the public accessibility condition to libraries and museums.

1. The main tasks of libraries include:

- 1) the collection, preparation, storage and protection of library materials;
- 2) services, primarily consisting of making collections accessible and information activities, especially information about the collection of their own, other libraries, museums and scientific information centres, as well as interaction with the archives in this area.

2. The tasks of the library may also include bibliographical, documentary, scientific-research, publishing, educational, popularizing and instructional-methodical activities.

<sup>630</sup> K. CREWS, *Study on Copyright Limitations and Exceptions for Libraries and Archives*, *op. cit.*, p. 32: "The United Kingdom law permits copies by librarians of prescribed libraries. The statute further defines "librarian" broadly as a person acting on behalf of a librarian. Where relevant, the U.K. statute gives similar treatment to "archivist." The U.K. law evidently is not limited to professional librarians, nor is it apparently limited to employees or regular staff of the library".

<sup>631</sup> Draft regulations for research, libraries and archives, June 2013, [www.ipo.gov.uk/techreview-research-library.pdf](http://www.ipo.gov.uk/techreview-research-library.pdf)

<sup>632</sup> Article 10, 10° of the Luxemburg Law of 18 April 2001 on Copyrights, Neighbouring Rights and Databases.

<sup>633</sup> Article 35, (4) of the Hungarian Act LXXVI of 22 June 1999 on Copyright.

<sup>634</sup> Article 28, (2) of the Polish Law No. 83 of 4 February 1994 on Copyright and Neighboring Rights.

<sup>635</sup> For a definition of the Hungarian notion of educational establishment, see article 33, (4) of the Hungarian Act LXXVI of 22 June 1999 on Copyright.

<sup>636</sup> Article 68, (2) of the Italian Law No. 633 of 22 April 1941 for the Protection of the Copyright and the Other Related Rights to its Exercise.

<sup>637</sup> See the discussion in M.-CH. JANSSENS, « Commentaar bij art. 21, 22, 22bis en 23bis Auteurswet », *La loi belge sur le droit d'auteur. Commentaire par article. Hommage à Jan Corbet*, 3<sup>e</sup> éd. révisité, Bruxelles, Larcier, 2012, p. 170.

<sup>638</sup> Article 37, (1) of the Spanish Consolidated Text of 1 April 1996 on Intellectual Property, including museums, libraries and archives that form part of institutions of cultural or scientific character (this at least should include universities, but maybe not schools by default of a reference to "institutions of educational character).

<sup>639</sup> Article 53, (2), subparagraph 1, point 2, with subparagraph, 2, point 3, of the German Act of 9 September 1965 on Copyright and Related Rights.

<sup>640</sup> Article 22, §1, 8° of the Belgian Law of 30 June 1994 related to Copyright and Neighboring Rights.

<sup>641</sup> Article L-122, subparagraph 1, 8° of the French Intellectual Property Code of 1 July 1992.

Against the text of the directive, some countries also impose that archives be accessible to the public, such as Denmark<sup>646</sup>, Italy<sup>647</sup>, Hungary (implicitly), the Netherlands.

The other condition appearing in recitals of the directive, the **non-profit nature** of the establishments concerned is not often explicit in national laws, but is transformed into a general requirement for the libraries not to act for commercial advantage. Only the UK copyright regulations explicitly excludes libraries and archives that are conducted for profit, which is defined as meaning “a library or archive which is established or conducted for profit or which forms part of, or is administered by, a body established or conducted for profit”<sup>648</sup>.

**Stricter conditions** are sometimes applied. For instance, Spain requires that the concerned establishments are in public ownership or form part of institution of cultural or scientific character in the reproduction exception<sup>649</sup>, museums in Denmark must be State-run museums, libraries must belong to the State or to public authorities in Italy<sup>650</sup>.

### c) Works concerned

Most of the countries analyzed authorize the reproduction of all works, whatever their type.

Belgium mentions safeguarding the cultural and scientific heritage<sup>651</sup> similarly as Luxemburg<sup>652</sup>, which speaks about “heritage” when determining the object of the purpose of preservation.

Denmark excludes computer programs but not computer games<sup>653</sup>. Italy has a two-prong exception, one targeting reprography of literary and printed works in public libraries and other establishments<sup>654</sup>, the other covering the reproduction in one single copy of sound and video recordings<sup>655</sup>. The Netherlands refers to literary, scientific or artistic works and the UK to literary, dramatic and musical works, but excludes sound recordings, films and broadcasts<sup>656</sup>. However, the current review of copyright exceptions considers extending the exceptions, for preservation and for making and supplying a copy to user or to other libraries, to all classes of copyrighted works, including broadcasts, sound and audiovisual works.

<sup>642</sup> Article 10, 10° and 14° of the Luxembourgish Law of 18 April 2001 on Copyrights, Neighbouring Rights and Databases.

<sup>643</sup> Article 16n and 15h of the Dutch Law containing New Regulation of Copyright of 23 September 1912.

<sup>644</sup> Article 35, (4) and 38, (5) of the Hungarian Act LXXVI of 22 June 1999 on Copyright.

<sup>645</sup> Article 68, (2) and 71ter of the Italian Law No. 633 of 22 April 1941 for the Protection of the Copyright and the Other Related Rights to its Exercise.

<sup>646</sup> Article 16, 16a, (1) and 16b of the Danish Consolidated Act No. 202 of 27 February 2010 on Copyright.

<sup>647</sup> Article 68, (2) and 71ter of the Italian Law No. 633 of 22 April 1941 for the Protection of the Copyright and the Other Related Rights to its Exercise.

<sup>648</sup> The Copyright (Librarians and Archivists (Copying of Copyright Material) Regulations 1989, section 3 (5). This Regulation will be revoked by the forthcoming review of copyright exceptions in the UK, but the requirement of being conducted not for profit will be added in the section of the CDPA dealing with libraries exceptions (with no definition though).

<sup>649</sup> Article 37, (1) of the Spanish Consolidated Text of 1 April 1996 on Intellectual Property.

<sup>650</sup> Article 69, (2) of the Italian Law No. 633 of 22 April 1941 for the Protection of the Copyright and the Other Related Rights to its Exercise.

<sup>651</sup> Article 22, §1, 8° of the Belgian Law of 30 June 1994 related to Copyright and Neighboring Rights.

<sup>652</sup> Article 10, 10° of the Luxemburg Law of 18 April 2001 on Copyrights, Neighbouring Rights and Databases.

<sup>653</sup> Article 16 and 16b of the Danish Consolidated Act No. 202 of 27 February 2010 on Copyright.

<sup>654</sup> Article 68, (2) of the Italian Law No. 633 of 22 April 1941 for the Protection of the Copyright and the Other Related Rights to its Exercise, *G.U.*, 16 July 1941, No. 166.

<sup>655</sup> Article 69, (2) of the Italian Law No. 633 of 22 April 1941 for the Protection of the Copyright and the Other Related Rights to its Exercise.

<sup>656</sup> Recordings of folklore songs and broadcasts for archival purposes is permitted under section 61 and 75 of the CDPA with an intricate procedure that will be simplified by the forthcoming review of copyright exceptions.

When supplying other libraries with copies of works, the Danish libraries can only copy articles from newspapers, magazines and composite works, brief excerpts of books and other published literary works, as well as illustrations and music reproduced in connection with the text<sup>657</sup>. The UK Copyright and Designs Protection Act also provides different rules for acts of making a copy and supplying it to users upon request, depending on the category of works<sup>658</sup>.

As to the portion of works that can be copied, it is subject to restrictions in Hungary as far as copying for the internal purposes of the institution are concerned (minor parts of a published work or newspapers or periodicals articles).

Concerning out-of-print works, their authorized use is extended in comparison with what libraries can do with other types of works, in Denmark<sup>659</sup>, in Germany (other personal uses are then possible) and in France, by virtue of a recent law on out-of-print works<sup>660</sup>. On the other hand, the making and supplying of a copy of unpublished works are subject to more restrictive conditions in the UK<sup>661</sup>.

#### d) Authorised acts

Even though the expression of “specific acts of reproduction” in the article 5(2) c) of the directive tends to indicate that authorized acts ought to be described in applicable laws, few Member States have elaborated on the acts of copying that would be admissible.

The purpose of **preservation**, as explained above, is sometimes restricted to restoration or replacement of a damaged or lost item (the Netherlands, UK, Denmark and Poland to some extent), to copying when the work is threatening to deteriorate (the Netherlands) or more rarely to format-shifting to counter obsolescence (the Netherlands).

Another declination of the “specific acts of reproduction” that is listed as an exception in UK, Germany and Hungary, is the possibility to **send a copy of a work in the collection of library upon an individual request**. In such a case, the conditions to be complied with are strictly defined and generally limited to a purpose of research or private study. At first sight, it does exceed the acts of reproduction for preservation, but the exception is not limited to that objective in the directive. The legislations concerned do not however specify what is the regime applicable to the sending of that copy to the requesting user. If the copy is sent by normal post, it is an act of distribution that could be added to the exception by the Member States on the ground of the article 5(4) of the directive, but the countries in questions have not referred to that provision specifically. The sending by email would be an act of communication that would go beyond what the directive allows, except if one considers that it does not amount to a communication to the *public* but only to one individual.

Some countries (e.g. France, Hungary, Luxemburg) authorise as well the copying of a work to the extent necessary to enable the **on-site consultation** provided for in another exception, which bridges the exception of article 5(2) c) to that of article 5(3) n) for on-site consultation (see *infra*).

Albeit the Directive does not forbid **digital copies**, some Member States have decided not to include the making of digital copies in the exception or only grant this possibility upon some conditions. The German copyright law only allows the archiving of a work on paper and for analogue uses<sup>662</sup> and similarly, only

---

<sup>657</sup> Article 16b of the Danish Consolidated Act No. 202 of 27 February 2010 on Copyright.

<sup>658</sup> Article 41 of the British Copyright, Designs and Patents Act of 15 November 1988: in order to supply to other libraries.

<sup>659</sup> Article 16 and 16b of the Danish Consolidated Act No. 202 of 27 February 2010 on Copyright.

<sup>660</sup> French Law n° 2012-287 of 1<sup>st</sup> March 2012 on the Exploitation of Digital Books Unavailable in the Twentieth Century, *J.O.*, n° 0053, 2 March 2012, p. 3986.

<sup>661</sup> Article 43 of the British Copyright, Designs and Patents Act of 15 November 1988.

<sup>662</sup> Article 53 of the German Act of 9 September 1965 on Copyright and Related Rights.

paper copies or digital copies as a graphic data file (thus equivalent to photocopies) can be sent to users requesting a copy of a work by libraries<sup>663</sup>.

The Italian copyright act only deals with photocopying within a library, archive or museum, of literary and print works, which does not permit the making of a digital copy<sup>664</sup>. As far as phonograms and videograms are concerned, only one reproduction is allowed and commentators claim that digitization of such materials should also be allowed under this provision “in order to enable purposes of long-term preservation of recordings in analogue or physical format”<sup>665</sup>.

An important limitation in the directive is that the acts concerned must not be “**for direct or indirect economic or commercial advantage**”. This has been reproduced in mostly all the Member States we have analyzed, *verbatim* (as in Belgium, France, Germany, Luxemburg, the Netherlands) or in similar wording (“not with gainful intent”<sup>666</sup>, “not done for commercial purposes”<sup>667</sup>, “not intended for earning of increasing income even in an indirect way”<sup>668</sup>). It is however generally not defined any further.

### e) Further conditions

Belgium<sup>669</sup> limits in a general manner the **number of copies** to what is required by the purpose of preservation. Similarly the Netherlands<sup>670</sup> permits any task, hence any number of copies, reasonably useful to achieve the specific preservation purpose included in the relevant provision. In France, as nothing is determined, several copies may be authorised when useful or needed to achieve the preservation purpose.

Italy<sup>671</sup> only allows a single copy in the case of reproduction of phonograms and videograms by libraries and record or video libraries belonging to the State or to the public authorities.

When dealing with the making of copies to supply upon request (which is, as seen earlier, an odd extension of the exception for preservation), the UK CDPA<sup>672</sup> states that no more than one copy of the same article or no copies of more than one article contained in the same issue of a periodical are to be delivered per person; no more than one copy of the same material or no copies of more than a reasonable proportion of any work; and no more than one copy of the same material deposited in the library or archive before the work has been published.

Also applicable to the UK exception of making and supplying a copy, the **payment of a sum** at least equivalent to the cost attributable to the production of the copy is foreseen<sup>673</sup>. For a similar exception

<sup>663</sup> Article 53a of the German Act of 9 September 1965 on Copyright and Related Rights. Electronic delivery of works by public libraries is also possible for the purpose of illustration for teaching or scientific research, to the extent justified by the non-commercial purpose to be achieved, or when it is not manifestly made possible, upon agreed contractual terms, for members of the public to access the contributions or small parts of a work from a place and at a time individually chosen by them and on fair terms.

<sup>664</sup> G. MAZZIOTTI, “Tecnologie digitali e diritti culturali: quale ruolo per le biblioteche?”, in A. Maggipinto and G. D’Ammassa (ed.), *Diritto e tecnologie digitali per la valorizzazione e l’accessibilità delle conoscenze*, Atti del Convegno 19-20 ottobre 2007, Nyberg, Milano, 2009, p. 87.

<sup>665</sup> See S. ERCOLANI, *Il diritto d’autore e I diritti connessi*, Torino, 2004, p. 290.

<sup>666</sup> Article 37, (1) of the Spanish Consolidated Text of 1 April 1996 on Intellectual Property.

<sup>667</sup> Article 16b of the Danish Consolidated Act No. 202 of 27 February 2010 on Copyright

<sup>668</sup> Article 35, (4) and 38, (5) of the Hungarian Act LXXVI of 22 June 1999 on Copyright.

<sup>669</sup> Article 22, §1, 8° of the Belgian Law of 30 June 1994 related to Copyright and Neighboring Rights, *M.B.*, 27 July 1994, p. 19297.

<sup>670</sup> Article 16n of the Dutch Auteurswet of 23 September 1912.

<sup>671</sup> Article 69, (2) of the Italian Law No. 633 of 22 April 1941 for the Protection of the Copyright and the Other Related Rights to its Exercise.

<sup>672</sup> Respectively articles 38, 39 and 43 of the British Copyright, Designs and Patents Act of 15 November 1988

<sup>673</sup> *ibidem*.

(delivery of copies), Germany<sup>674</sup> has opted for an exception with an equitable remuneration to the author and Denmark<sup>675</sup> applies an extended collective license system (which is actually not an exception but the very exercise of exclusive rights).

There is an interesting rule in the Belgian exception that deals with the distinction between the **ownership of the item** produced by the preservation and the exercise of the rights in the work itself (that is a key distinction in copyright between the work and its support). The article 21, 8° of the Belgian Copyright Act provides that “the material thus produced shall remain the property of these institutions which shall not engage in any commercial use or use for profit. The author may have access to the material, subject to strict respect for the preservation of the work and fair remuneration for the intervention of the institutions”. This provision comes from the former exception (before the transposition of the directive 2001/29) that benefited only to the Film Archive. It is not rare that a Film Archive is the holder of the only subsisting copy of a film. Its restoration is hence of particular interest to the copyright owners who need access to that copy to exploit their rights. The rule has been taken over with the extension of exception to all libraries and archives. It enables copyright owners to have access to the restored or preserved copies of their works when needed for exploitation of their rights, whereas the rights of the library or archive that has undertaken the preservation are preserved.

The library exception in Belgian law cannot be contracted out<sup>676</sup>, but this status has been qualified somehow when transposing the directive to consider that the exception is not imperative when the work is available at a place and a moment individually chosen by the user (on demand)<sup>677</sup>. The UK Government plans to introduce a similar rule in the CDPA when revising the exceptions for libraries. The exceptions of preservation will not be overridable by contract and any provision contrary to the law will be deemed unenforceable.

### 3. Overview of existing licensing mechanisms or collective agreements between stakeholders (namely for mass digitization)

The directive in its recital 40 encourages the recourse to specific contracts or licenses for what exceeds the “specific acts of reproduction” enabled by the article 5(2) c). At least for on-line delivery of protected works and other subject matter, agreements with copyright owners are indicated as a feasible solution to authorize such activities by libraries.

This solution was adopted by the Danish copyright law that organises the delivery of documents held in a library’s collection under the frame of an extended collective license.

The European Union has followed up that first call towards collective agreements by making the relevant stakeholders agree on a Memorandum of Understanding related to out of print literary works (for books and images embedded therein)<sup>678</sup> that encourages voluntary contractual agreements between right holders and digital libraries based on collective management<sup>679</sup>. In the *MoU* on out-of-print works, conditions of use of the works are negotiated within a predefined framework. The collecting societies will issue collective licenses to libraries and other concerned institutions. These collective agreements are to be negotiated in the country of first publication of the work and provide the type of permitted uses of works. When a right holder has not transferred its economic rights to a collecting society, the society

---

<sup>674</sup> Article 53a of the German Act of 9 September 1965 on Copyright and Related Rights.

<sup>675</sup> Article 16b of the Danish Consolidated Act No. 202 of 27 February 2010 on Copyright.

<sup>676</sup> Article 23bis of the Belgian Law of 30 June 1994 related to Copyright and Neighboring Rights, *M.B.*, 27 July 1994, p. 19297.

<sup>677</sup> This will be modified soon as a codification process of the intellectual property laws plans to restore the full imperative nature of the copyright exceptions with no limitation for works made available on demand.

<sup>678</sup> Memorandum of Understanding, Key Principles on the Digitisation and Making Available of Out-of-Commerce Works, 20 September 2011.

<sup>679</sup> See *infra*.

which manages the rights of the same category of works in the State of first publication, is presumed to manage these rights, provided that it has made efforts to alert the rights holder. Besides, if the scope of the agreement “includes cross-border and/or commercial uses, the collective management organization may limit its license of works that are out-of-commerce to those of represented right holders”. In such a case, “a specific procedure should be considered in order to reach the right holders who are presumed to be represented and whose works are used frequently or intensively”. In addition, the presumption of the collective management organization “shall also apply to acts of use of the work covered by the license which occur in a Member State which is not the Member State in which the license was agreed”. It therefore belongs to the signatories to implement it.

The Commission has stated that the *MoU* on out of print works should serve as a model for other sectors and does not exclude that “for the large-scale digitisation of out-of-commerce works, legislative backing for licensing solutions voluntarily developed by stakeholders may be needed in the Member States, taking into account the need to ensure a cross-border effect”<sup>680</sup>. Indeed, “Rights information databases connected at European level can bring down transaction costs for rights clearance. Such mechanisms should therefore be encouraged in close cooperation with all stakeholders”<sup>681</sup>. Member States should establish “the legal framework conditions to underpin licensing mechanisms identified and agreed by stakeholders for the large-scale digitisation and cross-border accessibility of works that are out-of-commerce” in order to “improve conditions for the digitisation and online accessibility of in-copyright material”<sup>682</sup>.

Projects inspired by the *MoU* start to emerge in Europe. A forerunner (not in the EU though) is an agreement entered between the Norwegian CMO Kopinor and the National Library of Norway on pilot project called “Bookshelf” that purports to make available on the internet all the Norwegian literature of the 20<sup>th</sup> century to users of a Norwegian IP address. The books will be digitized and could be consulted on screen but not downloadable, printed or borrowed.

In 2012, the Dutch Royal Library has cleared with national CMOs the right to digitize and making content from magazines from 1850 to 1940 available to the public through a dedicated website<sup>683</sup>.

On the legislative front, France and Germany have opted for collective management to foster digitisation and diffusion of cultural heritage. A recent law on the digital exploitation of unavailable works (that includes orphan works and out-of-print works)<sup>684</sup> sets up a principle of mandatory collective management for the digital exploitation of out-of-commerce books. Under the law, an unavailable book is a book published in France before 1 January 2001 which is no longer the subject of a commercial release by a publisher and which is not currently the subject of a publication in printed or digital form. The effect on libraries is only indirect and subsidiary, as the collective management that will exercise the rights in unavailable books<sup>685</sup> by default of an opt-out or of an exploitation by the rights holders<sup>686</sup>, will only grant a free license of reproduction and making available to libraries if the copyright owner could not be found

<sup>680</sup> Commission Recommendation of 27 October 2011 on the digitisation and online accessibility of cultural material and digital preservation, OJ, L 283 of 29 October 2011, p. 39, Recital 12.

<sup>681</sup> *Ibidem*, Recital 12 *in fine*.

<sup>682</sup> *Ibidem*, Article 6, b).

<sup>683</sup> <http://tijdschriften.kb.nl/>. See the press release (in Dutch) at [www.pictoright.nl/nieuws/images/KB-en-rechtenorganisaties-werken-samen-bij-toegang-cultureel-erfgoed.pdf](http://www.pictoright.nl/nieuws/images/KB-en-rechtenorganisaties-werken-samen-bij-toegang-cultureel-erfgoed.pdf).

<sup>684</sup> French Law n° 2012-287 of 1<sup>st</sup> March 2012 on the Exploitation of Digital Books Unavailable in the Twentieth Century, *J.O.*, n° 0053, 2 March 2012, p. 3986. – see E. DERIEUX, “Le régime juridique de l’exploitation numérique des livres indisponibles du XX<sup>e</sup> siècle. Cheval de Troie de Google ? Loi n° 2012-287 du 1<sup>er</sup> mars 2012 (Code de la propriété intellectuelle, articles L. 134-1 à L.134-9)”, *R.L.D.I.*, 2012, n° 87 ; CH. CARON, “Ce que dit la loi sur les livres indisponibles”, *Comm. Com. élect.*, 2012, n° 11, p. 26.

<sup>685</sup> The collecting society has to grant an exclusive license for a period of 10 years to the publisher assignee of the right of reproduction of the printed book. The publisher is then obliged to exploit the work within three years. In default, any person (e.g. other publishers or distribution platforms) can obtain from the collecting society a non exclusive license for a period of 5 years.

<sup>686</sup> Publisher and author of the book enjoy different possibilities to opt out of the list of unavailable books are obliged then to exploit their work.



within ten years after the first authorization to exploitation<sup>687</sup>. The main purpose of this scheme is therefore not to address the issue of digital libraries.

The German lawmaker has also proposed Amendments to the German Copyright Administration Act (“Urheberrechtswahrnehmungsgesetz”) with the objective to enable the digitisation and making available of out-of-commerce works through collective management. A registry of out-of-commerce works will be set up and authors not opting out of this registry will be presumed to be represented by the CMO of their respective field (text or image). Libraries holding such works in their collection will be authorized to reproduce and make those works available for non-commercial purposes.

A Task Force has been created by IFRRO to help implement the MoU at the European level<sup>688</sup>.

Agreements on digitization of audiovisual works are less easy to negotiate as they concern more copyright owners. Yet, examples of agreements leading to digitization of extensive archive of moving images have been reached in France (digitization and making available of the TV broadcasts of INA), the Netherlands (Images for the Future project of digitization and making available Dutch films and TV programs) and Belgium (project of online availability of the archives of the public TV broadcasting), all concluded with the national collective management organisations.

The process of Licenses for Europe launched by the European Commission in 2013 includes one working group on the audiovisual sector and cultural heritage institutions purporting to identify collaborative solutions to the online availability of audiovisual works (particularly those that are out of distribution). The MoU of 2011 on literary works could serve as a model but other types of solutions, such as framework contracts or best practice approach, are also envisaged.

The United Kingdom has started an interesting project of a so-called Copyright Hub whose objective would be to make the users and copyright owners meet to conclude licences to use copyrighted works. Digitization projects of libraries are envisaged as one of the application fields of this project aiming at making easier licensing related to high-volume, low-value transactions with high administration costs. This will provide another example of collective solutions put in place to help digitization endeavours by libraries.

It should be noted that all the examples listed here relate to the digitization and making available of works. For acts of digitization alone, we have not found collective agreements of any kind. This lets suppose that libraries rely on the exception for preservation purpose even if it is uncertain that it covers large-scale digitization projects.

#### **4. Assessment of the exception – Issues and uncertainties**

##### **a) Assessment of the adequacy of the exception in the directive**

The exception provided for in the article 5(2) c) of the InfoSoc Directive actually proves to be rather open and likely to meet numerous needs of the libraries. It is an open exception that potentially enables many acts of reproduction, to the extent they are specific, hence precisely described by the laws enacting it, and carried out with no direct or indirect commercial or economic advantage.

Acts of preservation and archiving are allowed but not defined. They certainly cover restoration or replacement of damaged or fragile items of a collection, as well as copying for format shifting to migrate the format of a work that has become obsolete or for which the means to access to its content are not easy to find.

---

<sup>687</sup> New article 134-8.

<sup>688</sup> Out-of-Commerce works MoU Implementation Task force (OMIT) see the IFRRO website.

Beyond preservation, the history of the legal provision indicates that other purposes are legitimate as well but does not indicate which ones could be considered. Some further interpretation may be needed here.

However the exception may not cover projects of mass-scale digitization as they shall probably go beyond the notion of “specific acts of reproduction”<sup>689</sup>. Yet, libraries, archives and museums in Europe have relied on that exception to engage in mass digitization, despite the absence of any legal security.

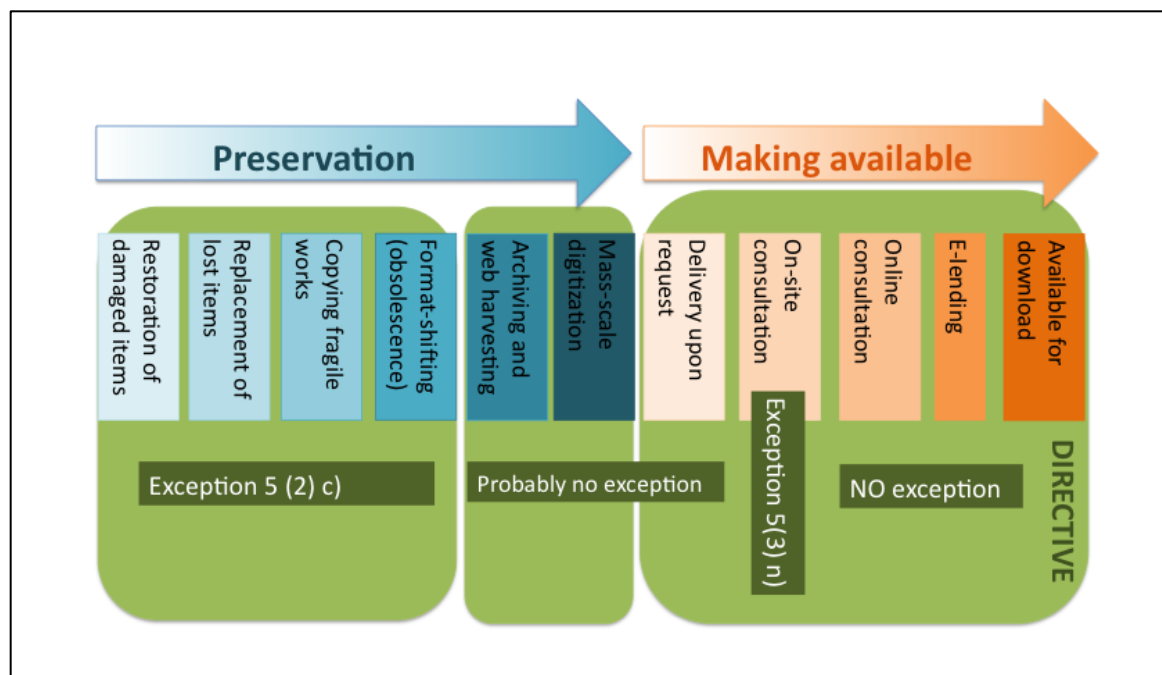

## b) Restrictive national transpositions

National transpositions of the exception have been often more restrictive than the European directive itself to the effect some national copyright laws do not meet the needs of digitization and preservation initiatives of heritage institutions. Four reasons can be identified to explain the more restrictive exceptions resulting from national transpositions.

The **purpose of preservation** has been generally interpreted strictly which prohibits libraries and other eligible institutions of some Member States from carrying some acts of preservation of their collections, notably acts of format shifting.

Not all **categories of works** are covered by the national laws, which can discriminate between libraries depending on the type of content they own. For example, in the UK, the exception does not apply to sound recordings or films, which has been denounced by the Gowers Report and the Hargreaves Report,

<sup>689</sup> J. AXHAMN & L. GUIBAULT, *op. cit.*, p. 17.

the latter proposing a revision of the exception to extend it to audiovisual cultural heritage<sup>690</sup>. On the contrary, text-based works are not concerned by the exception in Italy.

The making of **digital copies** is not allowed in some national laws, which creates a particular difficulty for film heritage institutions that have no other choice than to migrate audiovisual works from analogue to digital format both for reasons of fragile and deteriorating supports and for reasons of lack of projectors still capable of screening former formats.

The **number of copies** authorised for preservation of works constitutes another issue. For instance, UK only allows the making of a single copy, when digital preservation will involve multiple and serial copying and reformatting<sup>691</sup>. Digitization, especially for format-shifting, requires multiple copies.

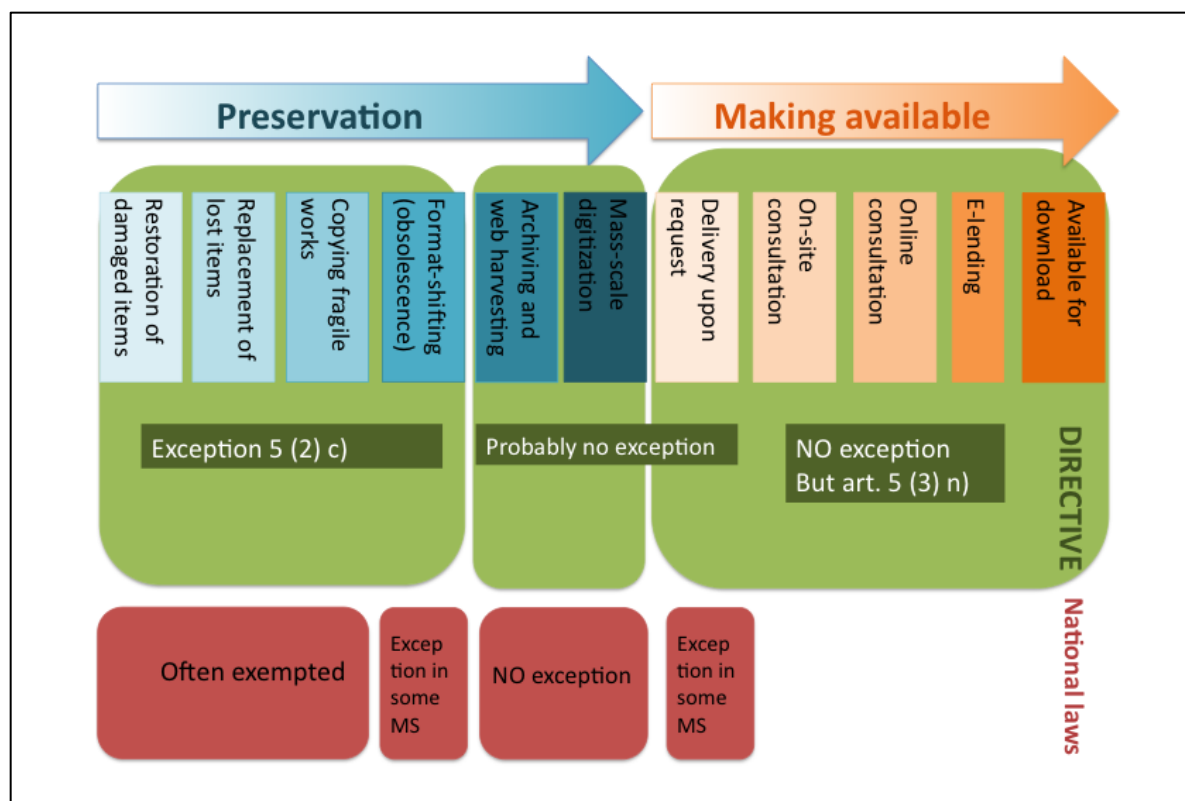

### c) Lack of harmonization and cross-border issues

At first sight, the acts covered by the exception of the article 5(2) c) does not have any cross-border dimension, since the acts of reproduction undertaken by libraries take place on a determined territory, that of the eligible institution.

<sup>690</sup> I. HARGREAVES, *Digital Opportunity – A Review of Intellectual Property and Growth*, 2011, [www.ipso.gov.uk/ipreview-finalreport.pdf](http://www.ipso.gov.uk/ipreview-finalreport.pdf), p. 42.

<sup>691</sup> THE LIBRARY OF CONGRESS NATIONAL DIGITAL INFORMATION INFRASTRUCTURE AND PRESERVATION PROGRAM, *International Study on the Impact of Copyright Law on Digital Preservation*, July 2008, [www.digitalpreservation.gov/documents/digital\\_preservation\\_final\\_report2008.pdf](http://www.digitalpreservation.gov/documents/digital_preservation_final_report2008.pdf), p. 101.

Notwithstanding the normally localised character of the acts of reproduction, some activities directly or indirectly concerned by the exception have a cross-border effect.

Firstly, if a library or other eligible institution wants to outsource the digitization of works abroad, the question of the territorial application of the exception can arise. As a principle, we consider that the outsourcing will not influence the eligibility of the library to benefit from the exception, that benefit being governed by the law of the country in which the library is established. The application of the exception to the library, and not the entity that carries out the acts of reproduction on its behalf and upon commission, would not prevent however that the acts undertaken by the latter be subject to copyright infringement should they exceed the boundaries of the exception and yield some independent benefit for the entity that digitizes the items of the library collection<sup>692</sup>.

A second case of transnational activity is the sending, by a library or archive, of copies of documents or works to a user upon request. That possibility is allowed in some national copyright laws, but with some uncertainty when a cross-border element, such as the fact that the user requesting the copy resides in another Member State, intervenes. In principle, the exception should apply depending on the location of the institution eligible by its national law to satisfy such demand for a copy of a work, but could it answer as well demands coming from abroad? When the exception, as it is often the case, is limited to research or private use, how would the library verify that the users requesting the copy meet those requirements?

Libraries can also collaborate to develop digital libraries projects and then assume a cross-border dimension, even though in such a case the transnational aspect will mostly relate to acts of making available that are situated outside of the scope of the exception.

Finally, the activities of the libraries have a transnational effect on a concrete level. On the one hand, heritage institutions are encouraged to mutualise their digitization activities to do economies of scale. As stated by recital 6 of the Recommendation on the digitisation and online accessibility of cultural material and digital preservation of 2006, a “concerted action by the Member States to digitise their cultural heritage would lend greater coherence to the selection of material and would avoid overlap in digitization”<sup>693</sup>. Article 1 recommends that Member States “gather information about current and planned digitisation of books (...) and create overviews of such digitisation in order to prevent duplication of efforts and promote collaboration and synergies at European level”. This has been further reminded in the update of the Recommendation in 2011, that insists on “the pooling of digitisation efforts by cultural institutions and cross-border collaboration, building on competence centres for digitisation in Europe”<sup>694</sup>. In other words, as underlined by the Council of the European Union, the aim is “to optimise the use of digitisation capacity to achieve economies of scale, keeping in mind the potential for cross-border collaboration”<sup>695</sup> in order to “ensure that online accessibility of Europe’s cultural heritage reaches a critical mass”<sup>696</sup>. Therefore, if a work is digitized by a library in a given country, it should be used by another library in the same country or in another Member State in order to achieve economies of scale to foster the development of digital libraries.

A last point should be highlighted as well. Since different conditions apply to the activities of libraries in Member States, due to inconsistent transposition of the exceptions, the inputs of national libraries or other

---

<sup>692</sup> M. BORGHI & S. KARAPAPA, *op. cit.*, p. 58.

<sup>693</sup> Commission Recommendation of 24 August 2006 on the digitisation and online accessibility of cultural material and digital preservation, 2006/585/EC, OJ, L 236 of 31 August 2006, p. 28.

<sup>694</sup> Commission Recommendation of 27 October 2011 on the digitisation and online accessibility of cultural material and digital preservation, OJ, L 283 of 29 October 2011, recommendation 4.

<sup>695</sup> Council conclusions of 10 May 2012 on the digitisation and online accessibility of cultural material and digital preservation, OJ, C 169 of 15 June 2012, p. 5, appendix.

<sup>696</sup> *ibidem*.

similar institutions to transnational projects dealing with cultural heritage, might largely differ. Imagine a national library digitizing its collection of newspapers from the 19<sup>th</sup> and 20<sup>th</sup> century, in the frame of a Europeana project to put on line newspapers relating to the construction of the European Union after 1945. It makes no doubt that the on-line dissemination of the newspapers, still protected by copyright, will require authorization of the copyright owners in all Member States. Depending on the national copyright law applicable to the library, the conditions to digitize the newspapers will be either exempted by an exception or not, which will have an indirect effect to the capacity of the national library to provide material to Europeana. Indeed, the more newspapers will be digitized, the more they could be of some use for digital projects. Additionally, a digitization with OCR mechanisms will enable search engines to properly index and locate relevant articles within the newspapers, which will save time and cost to libraries looking for material related to the European Community. Should some libraries be impaired in their efforts to digitize parts of their collections due to lack of harmonization of the exceptions to the benefit of libraries and archives, all cultural heritage institutions will not be on equal footing in such trans-European projects.

For all these reasons, more efforts should be put on increasing the harmonization in relation to the exception for certain acts of reproduction made by libraries.

## **5. Possible options**

The assessment of the exception in the directive and in its national transposition has showed two significant issues. Current needs of preservation are not permitted by the exception, either due to uncertainty of its scope or to development that could not be envisaged at the time of adoption of the directive. A second issue results from the very diverse implementation of the exception in the Member States that creates a fragmented scene for a European agenda of digitization of cultural heritage.

To address these issues, some possible initiatives will be now addressed. A primary exercise would be to find the gravity point where the exception ends and the exclusive rights resumes. It may not be a clear frontier, as some uses can be exempted but subject to fair compensation and the exclusive right can be mitigated, namely through collective exercise of rights, to accommodate particular needs and difficulties of digitization of cultural heritage. The watershed delineating the scope of exception and that of the exercise of copyright should be at least decided. A second stage would be to try and solve the issue of weak harmonization of the exception for libraries.

We will start by laying down the different factors and principles that should be weighed in the balance in devising the proper scope of the exception (a.). Based on those principles, we will analyze the option of revising the exception in the directive and define its possible scope and conditions (b.). Then different alternatives to increase the harmonization of the exception for libraries within the European Union will be considered (c.). Finally, on the other side of the (maybe redefined) exception, where the copyright owners can exercise their rights, some accommodations of the issues faced by libraries and similar institutions could be envisaged as well (d.)

### **a) Overarching principles and weighing factors**

In defining the adequate boundaries of an exception for some of the activities of libraries and similar institutions, some balance should be found between apparently contradictory objectives, on one hand securing the rights and interests of the copyright and related rightholders, on the other permitting the preservation of cultural heritage to the interest of the whole society and of future generations. The needs of the library increasingly developed in the digital environment but they should not be the only ones to dictate the scope and shape of the exception.

In a study commissioned by WIPO on the exceptions for libraries, K. Crews noted that “the library exceptions for preservation and replacement reflect a tension between meeting the needs of the library

while protecting the interests of copyright owners<sup>697</sup>. This tension explains that any accommodation of the needs of libraries and similar institutions to pursue their public interest mission could prejudice the interests of copyright owners in protecting their works and their business models, existing or to be developed.

The assessment of the need to revise the exception of certain acts of reproduction by libraries and archives and the methods for achieving such revision should then rely on two principles that need to be weighed in the balance. Firstly, the exception should serve the key role of libraries in preserving European cultural heritage; secondly, a high level of protection of copyright owners should be ensured which entails not to authorize acts that would adversely affect the market for copyrighted works. This balancing exercise should then conform to the three-step test that limits the exception to special cases that do not conflict with the normal exploitation of the work nor unreasonably prejudice the legitimate interests of the rights owners.

### **(i) The objective of the preservation and the role of cultural heritage institutions**

There is a strong political commitment of the European Union towards digital libraries and digitization of the cultural and informational heritage of the European Union, as demonstrated by a succession of policy documents and initiatives such as the High Level Group on digital libraries set up by the Commission in 2006, the Recommendation of the Commission on digitization of 2006 and its revision in 2011, the Report of the Comité des Sages on the Digitization of Europe's cultural heritage, the Council conclusions of 2012 on digitization of cultural heritage. All insist on the need to foster long-term digital preservation of cultural material, in full respect of international and European copyright laws. The New Renaissance Report affirms that "Digitization is more than a technical option, it is a moral obligation"<sup>698</sup>.

When the InfoSoc Directive was adopted in 2001, digital libraries were only beginning and no comprehensive efforts of digitization of libraries collection existed. The exception envisaged in the directive to the benefit of libraries, archives and museums mainly related to specific acts of preservation of works in case of deterioration, lost or frailness, not of mass-digitization that seems unattainable at that time.

The increasing need and political will to digitize *en masse* our cultural heritage may have disrupted the balance completed in the directive of 2001, as it changes the necessities of the knowledge society to put libraries on the front scene.

All initiatives should then take into account their impact on the development of digital libraries and of digitization of the European heritage. This would meet the demand of the CJEU to ensure the effectiveness of the exceptions (see *supra*). The additional principle of strict interpretation of the exceptions should equally require legal certainty.

### **(ii) The protection of rights and interests of copyright holders**

On the other side, one important objective of the InfoSoc Directive is to grant a high level of protection of copyright. Exceptions should remain limited and never prevail over the protection and the exploitation of copyright works and other subject matter. This favour granted to the protection of copyright explains the wide definitions of exclusive rights, the conditions that are generally required for exceptions, the rule of strict interpretation of exceptions.

Any revision or extension of the exception to meet the needs of digital libraries should not unduly harm the emergence of new business models, whether for books, movies or any other types of works likely to

---

<sup>697</sup> K. CREWS, *Study on Copyright Limitations and Exceptions for Libraries and Archives*, *op. cit.*, p.51.

<sup>698</sup> COMITÉ DES SAGES, *The New Renaissance*, Report of the Reflection group on bringing Europe's cultural heritage online, 2011, [http://ec.europa.eu/information\\_society/activities/digital\\_libraries/doc/refgroup/final\\_report\\_cds.pdf](http://ec.europa.eu/information_society/activities/digital_libraries/doc/refgroup/final_report_cds.pdf), p. 14.

be digitized by libraries. Publishers of e-books for instance are wary that the development of digital libraries be detrimental to their nascent new economical models and that through the exception, the libraries and similar institutions be authorized to transform their collection into digital objects, without acquiring the new digital products provided by the market. Some economic study of the possible impact on the interests of rightholders should assess whether the acts of digitization themselves for preservation purposes (and not the ensuing acts of making available that would not be covered by the exception) are likely to prejudice the interests of the copyright owners and the normal exploitation of works. In what follows, some hypothesis will be formulated when relevant.

### ***(iii) The Balancing test***

Balancing between the legitimate needs of libraries for preservation, that have been recognised by the European and national lawmakers as being of public interest, and the high level of protection of rightholders is a delicate exercise.

It should be done under the guidance of the three-step test. Reproduction for preservation is without doubt a specific case and fulfils the first step. The absence of harm to the normal exploitation of work would result in rejecting the exception if it creates a situation that has an adverse market impact. Libraries should not become the normal way to access works and prevail over market.

Already at the adoption of the directive, there was a certain fear that exempting too generously the activities of libraries could transform them into providers of copyrighted works at the detriment of nascent business models of on-line delivery. This idea can still be found in the recital 40 of the European text.

The three-step test adds to the exercise the absence of any unreasonable prejudice to the interests of copyright owners who could benefit accordingly of some compensation should an exception deprive them of some remuneration<sup>699</sup> or whose moral interests could be affected by the exception.

This balance will in some cases raise the question of whether the copyright owners could not provide the means to exercise the privileged use, namely by substituting the reproduction allowed by the exception by an acquisition of a copy of the work on the market. We have seen in the general introduction on the system of copyright exceptions in the European Union, that this possibility of market intervention should not be the only factor deciding on the limits of the exception. In what follows, we will address this dividing line between the exception and the intervention of the market, depending on the different objectives and acts authorised by a possibly revised exception, taking into account the high protection of authors.

## **b) Revising the scope of the exception**

### ***(i) Keeping the status quo***

Before developing what could be done to clarify or revise the scope of the exception for libraries in the directive, a first option could be not taking any initiative and considering that the current situation should be maintained.

Such a choice could find support in the open nature of the exception that seems to cover a broad range of purposes, to leave enough discretion to Member States to authorize specific acts of libraries according to their needs, and not to require any adaptation to fit the new digital needs of libraries, considering that such needs have already been taken into account in the text of 2001.

---

<sup>699</sup> No analysis of the three-step test will be carried out here, as the many interpretations of the test do not seem relevant or influential to assess the scope of the exception for libraries.

The recent case law of the CJEU further promises to bring more flexibility in the interpretation and application of the exceptions. We have seen in the introduction of this study that a series of decisions have attenuated the principle of strict interpretation of the exceptions and mixed it with a call for more harmonization and more purpose-bound effectiveness. According to the European Court, Member States have the obligation, when transposing the exception, to consider the harmonisation objective of the directive 2001/29 and to enable the exception to deliver what it was aimed for. On the one hand, Member States have been prevented to bring inconsistency in the European harmonized copyright framework and even, in one decision, to add supplementary conditions to exceptions already detailed in the directive<sup>700</sup>. On the other hand, the court of Luxembourg affirmed that the strict interpretation of the exceptions should leave some room for a teleological approach and the need to ensure the effectiveness of the exception, according to its objective as pursued by the directive<sup>701</sup>.

This twofold position of the CJEU indicates that the Member States should refrain from differing too much from the wording of the exceptions in the directive 2001/29 or at least, from prescribing conditions to the exercise of an exception that would hinder its objective and its value to achieve information society needs.

More generally, the European judges have reduced the margin of implementation and interpretation by the Member States by giving their autonomous interpretation of an increasing list of notions in the directives of the *acquis*.

Should the CJEU keeps that path and pace, the exception for reproduction by libraries, museums and archives may find soon some clarification in the case law, without the need of any legislative action.

### **Advantage(s)**

The main advantage of this option would be that it does not require to re-open the highly politicized debate of copyright exceptions and that it would leave intact an exception that seems in itself not problematic and balanced.

### **Disadvantage(s)**

Relying on a possible intervention of the CJEU to clarify the exception for preservation benefiting to libraries is a risky bet, for the Court will only haphazardly answer to preliminary questions referred to its jurisdiction. Past decisions showed that the questions were often limited and did not allow the European Court to address the overall context of a copyright exception as the lawmaker could do.

Besides, the recent shift of the case law towards a more flexible interpretation of the Court is only nascent and at the margins of stronger principles that dominate the interpretation of copyright, such as the need to grant a high level of protection to copyright owners.

Another factor in disfavour of inaction is that digital libraries have become an issue that is high on the agenda of the European Union. More legal certainty as to the scope of authorized activities by libraries and as to the ways libraries could clear copyright to engage in digitization projects has been repeatedly asked by the European Council<sup>702</sup> and by the Commission itself<sup>703</sup>. Revising the exception is maybe not

---

<sup>700</sup> C.J.E.U., judgment of 1 December 2011, C-145/10, *Painer*.

<sup>701</sup> C.J.E.U., judgment of 4 October 2011, C-403/08 and C-429/08, *Football Association Premier League and others*.

<sup>702</sup> Council conclusions of 10 May 2012 on the digitisation and online accessibility of cultural material and digital preservation, OJ, C 169 of 15 June 2012.

<sup>703</sup> Communication of the Commission, Copyright in the Knowledge Economy, 19.10.2009, COM(2009) 532 final ; Communication from the Commission to the European Parliament, the Council, the European Economic and Social Committee and the Committee of the Regions, *a Digital Agenda for Europe*, 26.8.2010, COM(2010) 245 final/2 ; Commission Recommendation of 24 August 2006 on the digitisation and online accessibility of cultural material and digital preservation, 2006/585/EC, OJ, L 236 of 31 August 2006.



the right solution or not the only one, but maintaining the status quo would give a wrong signal at a time when, to paraphrase J. Ginsburg, “digital libraries are all the rage”<sup>704</sup>.

### **(ii) Adoption of an interpretative document**

This study showed major uncertainties as to the scope of the exception of acts of reproduction for libraries that result from the directive and, to a larger extent, from its transposition by Member States. At the risk of repeating ourselves too much, the biggest holes in the understanding and effectiveness of the exception are on the side of the directive itself, the uncertainty as to the treatment of mass-digitization projects and digitization for format-shifting (which seem both rather not covered by the exception), and, on the side of national transpositions, exceedingly restrictive conditions that prevent libraries to actually benefit from the room given to them by the EU lawmaker.

An interpretative document or guidelines published by the Commission<sup>705</sup> could provide two answers. One would specify the purposes of the exception and ascertain whether reproduction, even of whole collections, for format shifting or mass-digitization, is allowed. The other would identify the objective of the exception that should not be impaired by Member States in their own copyright law, for instance by prohibiting digital copying, excluding some classes of works or admitting only one copy to be made.

Due to its nature, an interpretative communication could not go in a much detail as the revision of the exception but it could follow the lines that will be addressed in the next point related to the revision of the exception in the directive.

### **Advantage(s)**

Without re-opening the Pandora box of copyright exceptions in the directive 2001/29, an interpretative document would provide a soft law instrument to clarify pressing issues of the exception in favour of cultural heritage institutions. It could provide useful guidance to Member States about the scope and conditions of the exception without requiring starting the whole process of defining and exception and implementing it in the national copyright regulatory framework. It could be sufficient as we have seen that the issue is more about the interpretation of the open wording of the directive than about too restrictive or outdated conditions (which would rather require a legislative intervention).

By interpreting the directive more than 10 years after its adoption, the Commission could emphasize the overall objective that was intended in 2001 to the benefit of libraries without impairing the high protection and legitimate interests of copyright holders, and its continued significance and need for adaptation to current needs of libraries. Instead of waiting for the CJEU to address the uncertainties of the article 5(2) c) and probably giving answers, case by case, to the questions identified here, it could further more harmonization and consistency by addressing the whole context of the use of copyrighted works by libraries and similar institutions.

### **Disadvantage(s)**

Interpretative documents are not a habit of the European Union in the field of copyright. Communications of the Commission in some fields or evaluation reports of directives sometimes give some clues as to how some provisions of an European text ought be understood and applied. However, such interpretation would not be binding. Examples of interpretative document at the European Union level always affirm that they do not provide authentic interpretation of the commented legal instrument. The CJEU and the

---

<sup>704</sup> The phrase is taken from J. GINSBURG, who applied it to public domain. J. GINSBURG, “‘Une chose publique’? - The Author’s Domain and the Public Domain in Early British, French and US Copyright Law”, in P. Torremans (ed.), *Copyright Law: A Handbook of Contemporary Research*, Edgar Elgar, 2007, p. 133.

<sup>705</sup> Interpretative documents have sometimes been adopted by the European Commission in other fields of law. See the references given in the Report on UGC, Part II.

Member States would remain free to refer to such soft-law guidelines<sup>706</sup>, even though one should mention that the European Court has sometimes referred to the interpretative guide to the Berne Convention<sup>707</sup> while interpreting the provisions of the Berne Convention in copyright cases.

Beyond the question of legitimacy and binding nature of such document, its efficiency as to its time of adoption could also be doubted. Interpretative documents can be particularly useful when adopted simultaneously to the legislative acts they comment (as recitals of a directive do) or when there is a need to address new issues<sup>708</sup>. As far as article 5(2) c) is concerned, an interpretation of its wording and scope more than ten years after its adoption and many years after its implementation in the Member States, might come too late. Restrictions as to the scope of the exception mainly result from national copyright laws that the Member States will not modify only for the sake of complying with an interpretative document, whose legitimacy to impose such a revision at the Member States level, would be dubious. One can also doubt that national courts, when applying a national exception, would make prevail an interpretative document of the European Commission over national legal provisions.

### ***(iii) Modification of the exception in the directive***

The exception of the article 5(2) c) was adopted at a time where libraries were only emerging as digital actors. The hot topic of “digital libraries” would be created only a few years afterwards. That might explain that the directive, in 2001, only touches upon specific acts of reproduction that were then undertaken by libraries to preserve or restore works but not upon more comprehensive activities that would result from the new role assumed by libraries in the information society.

Exceptions are, as reminded by the Preamble of the directive itself, a way to create some balance between the rights of copyright and related rights owners and the interests of the society as a whole and particularly, of access to information and education. Time influences, not the very need for balance, but the extent and way this balance is conveyed in law. The needs of libraries and cultural heritage institutions evolve, as well as their activities. Consequently the extent of the authorized acts could evolve both to allow for some new activities and to restrict some uses that have endowed new significance to the detriment of the interests of the rights holders. This on-going adjustment of the exceptions (and of the balance they embed) is thus not one-dimensional.

This change of circumstances, the libraries being more digitally active, is a first argument pleading for a revision of the exception to their benefit. The argument is reinforced by the calls of the Commission itself and the Council to look at the way the activities of cultural heritage institutions are aided by the copyright law<sup>709</sup>, “in full respect of intellectual property right” as it is carefully reminded in all instances<sup>710</sup>.

Consequently, the Commission could thus propose amendments to the InfoSoc Directive to the effect that the exception of article 5(2) c) regarding the specific acts of reproduction undertaken by libraries, museums and archives, be better defined and its exact scope determined.

Should the European lawmaker decide to re-open the directive and revise some of its provisions, an intervention may be needed in two directions, responding to the two issues emphasized in the

---

<sup>706</sup> As recalled, for the CJEU, by Advocate General in Case C-306/05, opinion delivered by Advocate General Sharpston on 13 July 2006, SGAE, paragraph 45.

<sup>707</sup> C. MASSOUYÉ, *Guide de la convention de Berne pour la protection des œuvres littéraires et artistiques*, (Acte de Paris, 1971), Genève, WIPO, 1978, 251 p. Second edition in 2003.

<sup>708</sup> This is the case of the UGC issue, for which an interpretative document, as argued by the report dedicated thereto, could be useful.

<sup>709</sup> Communication of the Commission, Copyright in the Knowledge Economy, 19.10.2009, COM(2009) 532 final ; Communication from the Commission to the European Parliament, the Council, the European Economic and Social Committee and the Committee of the Regions, *a Digital Agenda for Europe*, 26.8.2010, COM(2010) 245 final/2.

<sup>710</sup> *Ibidem*.

assessment of the exception done above, i.e. the lack of certainty as to the scope of the exception and the lack of harmonization amongst Member States.

Therefore, in order to properly revise the exception for libraries, one should endeavour, on one hand, to address the material scope of the law and, on the other hand, to achieve more harmonization as to its implementation at national level. The second line of action will be addressed in a later point.

### **Advantage(s)**

Revising the exception and finding ways to reduce the margin of appreciation of the Member States in its implementation would be one way to answer to the difficulties that libraries are facing with digitization projects, as pointed out by numerous policy documents of the European Union.

It could give better direction to Member States to revise their own exception and hence, reduce discrepancies and lack of harmonisation.

### **Disadvantage(s)**

The exception contained in the article 5(2) c) of the directive, as worded, is open and flexible enough, as we have showed, to accommodate the changing needs of the libraries to a large extent<sup>711</sup>. It is rather the transposition made by some Member States that proved to be too restrictive. Therefore, changing the directive will not help if no further harmonisation efforts are equally accomplished by the Member States.

Revising the directive is a tricky and lengthy process with difficult political issues. The recent discussion for an international Treaty to enact a copyright exception for the benefit of the visually impaired showed the reluctance of copyright owners and of some States to put the topic of exceptions on the legislative agenda in fear of precedent and of a Pandora-box effect. The analogy is not completely accurate as the libraries exception already exists in the *acquis communautaire* but fails to deliver its objective to some extent.

Should the exception be revised in the directive, a first question should be addressed: to *what extent of details* the conditions of the exception should go?

Legislative drafting techniques greatly differ from one Member State to another<sup>712</sup>, from the traditionally synthetic and open exception of French copyright law<sup>713</sup> to the intricate and detailed approach of common law<sup>714</sup>. The list of the exceptions in the article 5 of the directive is mixed. Some exceptions are simple and open-worded (eg parody, private copy...), while others know strictly defined conditions (eg temporary copying, on-site consultation, ...). The exception of article 5(2) c) is an example of the first kind. Detailed conditions have the advantage of reducing the discretion left to Member States to veer away the objective pursued by the European text. However it could add difficulties of two kinds. First, reaching a political compromise on many conditions and elements of the exception is certainly more arduous. Second, it imposes a peculiar legislative drafting style to Member States that could interfere with their own traditions.

Depending on the level of details the exception should comprise, the following conditions need to be factored in: the objectives pursued by the exception, its beneficiaries, i.e. the institutions eligible to the benefit of the exception, the works concerned, the authorized acts, as well as any further conditions or limitations.

---

<sup>711</sup> Acts of format-shifting and mass digitization are not included in the exception though, but it remains to be decided whether these uses should be covered by an exception.

<sup>712</sup>On this divergence as a factor explaining the lack of harmonization of exceptions in the EU, see B. HUGENHOLTZ ET AL., *The Recasting of Copyright, op. cit.*, p. 59-60.

<sup>713</sup> That has been largely negated by recent exceptions that are more complicated.

<sup>714</sup> Where conditions of exceptions might be further elaborated by Regulations ancillary to the Copyright Act.

- **The objectives of the exception**

The directive already authorises diverse purposes for the “specific acts of reproduction” that libraries, museums and archives can benefit from, without identifying them precisely. The history of the adoption of the directive mentions preservation and archive.

It could be useful to specify which purposes can be enabled by the exception, as it would provide the general frame of the limitation to copyright.

This purpose will certainly include preservation and archiving that would deserve some definition, preferably in recitals or an interpretative document.

The notion of preservation and archiving can encompass the following activities, depending of a strict or broad interpretation:

- **Restoration** of damaged parts of a work (mainly literary work, sound recording, broadcast or film) whose support has deteriorated or missing parts;
- **Replacement** of a lost or decayed item
- **Anticipative preservation** of fragile works or works in fragile support that threaten to fall in despair;
- **Copying often-consulted works** in a format that would better sustain regular viewings by library patrons;
- **Format-shifting** i.e. migration of works from a format that is obsolete or for which there is a difficulty to find viewing or reading material, to a more stable format (not always digital);
- **Copying to archive a work** in a library or archive collection, including **web harvesting** in order to archive web content.

Beyond mere preservation, libraries or archives sometimes copy works in their collection either **to supply other libraries or users** requesting such copy for research or private study.

Many libraries have engaged in **mass-digitization** of their collections or of substantial parts thereof. Digitizing a whole collection without differentiating between works and their specific needs for preservation can pursue many purposes. It could be a way to shift the analogue format of a collection to a digital one to ensure its preservation over time. Usually such format-shifting will be done regularly to follow the on-going change of readable formats.

Once digitized, the collection of an archive, library or museum, depending on the process of digitization (whether in graphic file or in a text-based version capable of being recognised by OCR tools), could be more easily searchable and indexed, which adds significant value of the digital library.

The ultimate purpose of mass-digitization projects is to make the works available on-line, which is an act that exceeds largely the strict purpose of preservation and would hamper the development of on-line services by the copyright owners themselves. The recital 40 of the directive clearly indicates that the exception should not cover on-line delivery services.

In the revision of the exception, its objectives should be clarified. It implies deciding where the exception would stop in the continuum of the discrete activities of copying undertaken by the concerned institutions:

*Restoration – replacement – anticipative preservation of fragile works – format-shifting – copying for archiving, including web harvesting – copying and supplying upon request – mass digitization for preservation – mass digitization with search capabilities – mass-digitization and making available*

Possible scope of a revised exception:

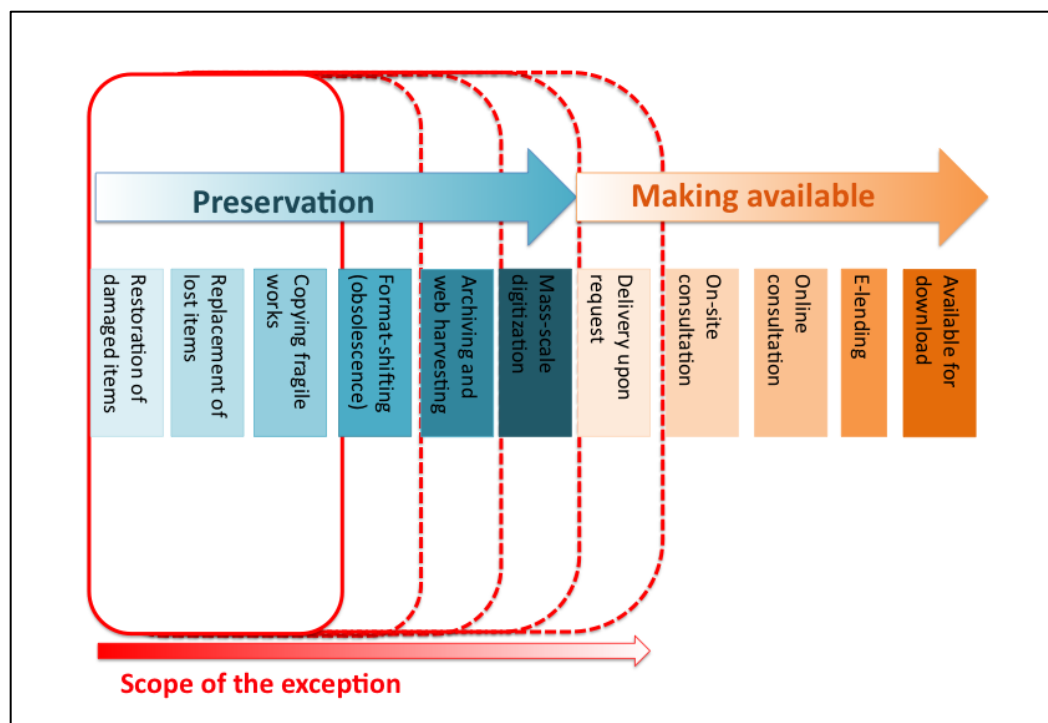

In our opinion, the following purposes should be included in the scope of the exception:

- **any act of preservation of single works** aiming at countering a risk of losing a specific item in a collection should be allowed, as it is already the case in the exception. It would cover restoration, replacement, anticipative copying of fragile works or of often-consulted items. Such acts do not normally affect the normal exploitation of works or the interests of copyright owners. Some national laws restrict acts of copying to replace lost or damaged works where the work is still available by the publisher or in normal trade. In that case indeed, it could be discussed as to whether the library should not acquire a new copy of the work rather than copying it to replace it<sup>715</sup>. It seems that the restoration only concerns a small part of the work, it might be done by an act of reproduction (e.g. of one missing or torn page) without having to replace the whole work by a new copy.
- **Format-shifting** should be authorised by the exception, as probably already covered by the directive and as recommended by the Recommendation of the Commission on digitization<sup>716</sup>. In a digital environment, format-shifting constitutes a key concern for cultural heritage institutions that need to keep up the pace of rapid changes in technology. Particularly in case of 'technological obsolescence', when technologies evolve and works are no longer "usable" because the technology needed disappeared<sup>717</sup>, preservation if done only once, would be useless. Maintaining works in formats that might not be readable anymore by future generations would severely impair the preservation mission of those institutions. Updating the format of a work only substitutes one format to another that is useless or will be soon. It does not in principle substitute for the

<sup>715</sup> Actually it seems a bit contradictory to allow the making of a lost work to replace it. If a work is lost, there is no way to copy it.

<sup>716</sup> Commission Recommendation of 24 August 2006 on the digitisation and online accessibility of cultural material and digital preservation, 2006/585/EC, OJ, L 236 of 31 August 2006, point 9.

<sup>717</sup> F. STASSE, *Rapport au ministre de la culture et de la communication sur l'accès aux œuvres numériques conservées par les bibliothèques publiques*, 2005, [www.ladocumentationfrancaise.fr/rapports-publics/054000450/index.shtml](http://www.ladocumentationfrancaise.fr/rapports-publics/054000450/index.shtml), p. 15.

acquisition of the work on the market and its normal exploitation as the library has already acquired the work. It could be discussed though whether the normal exploitation of a work does not imply to sell DVDs of a film to a library even if it has already a VHS of the same film in its collection. Most probably the cost of acquiring the film in the new format will be lower for the library than the cost to migrate the VHS into a digital copy and its quality will be better than a digitized version of an analogue copy.

- **Mass digitization** appears to be the utmost comprehensive act of preservation that can be undertaken by a library or archive. As such, its status under the article 5(2) c) is uncertain as it probably exceeds the notion of “specific acts of copying”. Digitization aims at achieving three objectives for a library: preservation, accessibility and collection management<sup>718</sup>.

As far as preservation is concerned, the digitization of a whole collection or of parts of it can be seen as a way to achieve format-shifting, the analogue format being increasingly, and particularly for sounds recordings or audiovisual works, condemned to disappear or rendered unreadable by lack of analogue equipment. Yet, a key mission of cultural heritage institutions is to keep the works in a state that enables their viewing and consultation. In a digital environment, they would fail that mission if their collection stays in an analogue format only. For that reason, we consider that mass-digitization should be considered as an act of preservation<sup>719</sup>.

An important rationale of digitisation projects for cultural heritage institutions is to provide increased availability to the items in their collection, preservation sometimes being secondary. Transforming an analogue collection into a digital one is in some cases required to make it accessible. For instance when part of the collection consists of photographic negatives, they could be effectively accessed and viewed by the public once digitized.

The mere act of digitization, irrespective of further uses that could be made of such digitized item, such as the making available, even of a whole collection, does not in itself harm the normal exploitation of the works, if the copies serve the same purpose than the analogue works they replace.

The addition of search tools and indexing in text-based works digitized and OCRized gives more value to a digital collection. On one hand they are the digital equivalents of research tools already offered by libraries to their analogue collection but in a more sophisticated and efficient form<sup>720</sup>. In itself its addition to mass-digitization processes should not disqualify digitization activities from benefiting from the exception. For instance, a national library that digitizes its collection of newspaper would include a search tool based on text-recognition and keywords which will greatly facilitate the research on some topics. There is no reason why the library should be limited to offer only index cards and not take advantage of new digital search capabilities. Nevertheless, coupling digitization and search tools should not end in making a database of works that would compete with a product existing on the market. For instance a law library could not digitize all its law reviews to constitute a searchable database instead of acquiring existing products offered on the market. In such a case, the benefit of the exception would be in contradiction with the normal exploitation of protected subject-matter (the articles as works and the database of articles).

The other purposes enabled by the digital copies of the works in the collection of a library, such as consultation on screens or making available should be considered on their own.

Other purposes merit further discussion:

---

<sup>718</sup> S. CORBETT, *Archiving our culture in a digital environment: Copyright law and digitization practices in cultural heritage institutions*, 2001, available at <http://ssrn.com/abstract=2040977>; see also M. BORGHI & S. KARAPAPA, *op. cit.*, p. 11.

<sup>719</sup> Without making the distinction at this stage as whether it could cover all works in a collection or only works that are not available on the market in a digital format. We will address that point later.

<sup>720</sup> M. BORGHI & S. KARAPAPA, *op. cit.*

- **Copying for archiving and web harvesting has been assumed by some projects to archive digital** contents found on the web. Two separate activities should be distinguished. Libraries can sometimes collect on the internet copies of works that are subject to legal deposit obligations. In other cases, not always initiated by traditional libraries or archives, the purpose is to operate a bulk copying of webpages to constitute an archive of everything that was ever posted online. Allowing web harvesting to the whole web under an exception would be too extensive and beyond the webpages it would capture as such, it could also copy all types of works included therein. Some specific acts of reproduction could be allowed to libraries in charge of legal deposit when the creator, publisher or other person liable to deposit a copy of the work under the law failed to do so<sup>721</sup>. Other libraries could not constitute their collection by making their own copies and not acquiring works in normal trade. However the historical and research interest of web harvesting merits that further discussion be dedicated to such activities<sup>722</sup>.

By way of comparison, the “Section 108 Study Group” entrusted by the US Copyright Office to provide recommendations on a revision of exceptions for libraries, has proposed to allow libraries and archives “to capture and reproduce publicly available online content for preservation purposes, and to make those copies accessible to users for purposes of private study, scholarship, or research”<sup>723</sup> provided the copies integrate a label indicating the archived nature of the copy and its purposes. However, it is also suggested to allow rights holders to opt-out of that system by indicating that their online content should not be harvested<sup>724</sup>. This extension to web harvesting was considered as being too broad by the US Copyright Office.

- **Copying and supplying on request** contradicts the recital 40 of the directive that excludes on-line delivery of works from the scope of the article 5(2) c). However it could be interpreted as referring to acts of making available on-line, whereas sending a digital copy of a work upon request of an individual user has a more limited scope and impact. When authorized in national laws (e.g. UK or Germany), many conditions apply to ascertain that the request is motivated by research or private study and that only single copies will be sent. The supply of copies on request should not substitute to existing services by copyright owners. It would actually be a way to acquire works, outside of normal trade, but this is exactly what libraries have always offered. The question is rather whether the extent of what could be allowed by the exception could constitute the normal way of acquiring works and impair thereby the normal exploitation of the work.
- **Making available** digital copies of the works contained in libraries collection for consultation or on-line, save for what is authorized under the exception of the article 5(3) n), should in any case be excluded. It is not an act of reproduction nor does it aim at preservation.

- **Beneficiaries – eligibility**

The article 5(2) c) is very clear in the identification of the beneficiaries of the exception. It is a closed list encompassing libraries, archives, educational establishments and museums. This list should not be changed or extended to other institutions as it already covers the justified candidates for the exception of preservation of cultural heritage.

---

<sup>721</sup> The French Heritage Code, for instance, allows such a reproduction for legal deposit of works (arts. L. 131-1 seq.).

<sup>722</sup> In favour of the inclusion of web harvesting in the exception, T. DREIER, *op. cit.*, p. 191.

<sup>723</sup> THE SECTION 108 STUDY GROUP, *Report*, An Independent Report sponsored by the United States Copyright Office and the National Digital Information Infrastructure and Preservation Program of the Library of Congress, 2008, [www.section108.gov/docs/Sec108StudyGroupReport.pdf](http://www.section108.gov/docs/Sec108StudyGroupReport.pdf), p. iv to viii.

<sup>724</sup> *Ibidem*.

Some doubt has arisen as to the inclusion of film heritage institutions but those should be considered as archives or libraries. To lift any uncertainty, the revision of the directive or an interpretative document could specify that film archives are covered.

The conditions applicable to the eligible institutions, i.e. the not-for-profit nature and the openness to the public (but for archives), further restrict the exception to reasonable application and should be kept.

Possible additions, through revision or interpretative document, could be:

- requiring that the institution pursues a **public service mission or scientific or educational goals**, as it appears in some national laws;

- allowing **outsourcing of digitization activities** by private companies or any other person acting on behalf of eligible institutions and within the conditions applicable to the latter. This could be done a recital similar to the recital 41 of the directive 2001/29 applicable to the exception for ephemeral recordings that states that “When applying the exception or limitation in respect of ephemeral recordings made by broadcasting organisations it is understood that a broadcaster’s own facilities include those of a person acting on behalf of and under the responsibility of the broadcasting organization”. The CJEU has considered that the intention of the EU legislature was “to maintain a close link between that third party and the broadcasting organisation, which ensures that the third party cannot profit, independently, from the exception in respect of ephemeral recordings, the sole beneficiary of which is the broadcasting organization”<sup>725</sup>. Similarly, a close link between the library and the person undertaking the acts of copying should be required and the latter could not profit in any way of the copies made in that process. As to the justification of this outsourcing possibility for the exception for ephemeral recordings, the European Court has found it in the freedom of conduct business contained in the EU Charter of Fundamental Rights<sup>726</sup>, which would be applicable as well to libraries.

Outsourcing, in the form of public-private partnerships, is also seen as a privileged way to assume the costs of digitization for libraries by the Report of the Comité des Sages. In the United States, the Study Group in charge of assessing the Section 108 of the Copyright Act related to libraries exceptions also recommended that these institutions be allowed to outsource their activities to outside contractors provided the contractor “is acting solely as the provider of a service for which compensation is made by the library or archives and not for any other direct or indirect commercial benefit”<sup>727</sup> and that he does not retain any copies of the work other than those necessary to accomplish its task.

- **Works concerned**

The Directive does not restrict the types of works benefiting from the exception and there should be no reason to exclude any classes of works. Yet, some Member States allows the reproduction only for literary works or exclude audiovisual material. This limitation in some national laws could hamper the preservation of the European heritage as a whole and the development of an information society including all types of content, from texts to images, sounds and multimedia works.

In our view, there is no rationale to exclude some classes of works from the preservation ambition for there is no reason for a different market effect depending on the type of works, to the extent the exception only covers preservation and not dissemination.

---

<sup>725</sup> C.J.E.U., judgment of 26 April 2012, C-510/10, *DR and TV2 Danmark*, paragraph 51.

<sup>726</sup> *Ibidem*.

<sup>727</sup> THE SECTION 108 STUDY GROUP, *op. cit.*



As no exclusion of content results from the directive, the exception does not need to be adapted in that regard but it could be made clear, in a recital or in an interpretative document, that it applies (and should apply) to all types of works.

It should be reminded here that **computer programs and databases**, protected on the grounds of other directives, are not subject to a similar exception. As further developed above, there is a nascent need and desire of specialised archives and museums to archive and preserve computer games and programs. Technically, by virtue of the distributed application of directive 2001/29 to graphic elements of the software and of directive 2009/24 (computer programs directive) to literary elements operated by the CJEU in the BSA case, computer games could enter the scope of the article 5(2) c) at least for their graphic elements. As to databases, Member States are entitled to apply thereto a similar exception for libraries, according to article 6(2) d) of the database directive.

However, some clarification and overall application of the preservation exception across the different subject matters would be a welcomed clarification and would bring consistency in the *acquis communautaire* and in the understanding of the law by libraries.

There may be further discussion on the following points:

- **Unpublished works:** there is no tradition in the *acquis communautaire* to apply a differentiated treatment to published and unpublished works. However the reason thereof is more related to the reluctance to deal with moral rights than to a consideration that the issue is irrelevant. In many Member States, exceptions are only admissible once the work has been published, publicly made available or disclosed and it would be difficult to intervene in that field, that is very sensible in a number of countries, as the discussion of the orphan works directive has showed. A sound solution would be to leave the matter at the discretion of Member States. However, unpublished works have often a critical importance for historical, scientific or cultural reasons and intrinsically belong to the cultural heritage whose preservation has been declared as a European policy objective. If the act is limited to reproduction for archiving and preservation, its effect is similar to the holding by the library of an unpublished work. The issue of a divulgation beyond the intention of the author will rather intervene if the work is made available to the public, in contradiction to the moral right of divulgation and possible privacy concerns. We would suggest that the exception for preservation allows the reproduction of unpublished works for preservation and archiving purposes, including format-shifting and mass digitisation, upon the condition that some indication of the unpublished status of the work appears on the copies, but that further acts of public disclosure or communication be restrained, by lack of the explicit consent of the copyright owners.
- limitation of preservation to works no longer commercially available

The High level Group of Digital Libraries suggests that preservation should be justified only for works that are no longer commercially available in any format, considering that if the work is available on the market there would no need to preserve it except within national libraries' deposit schemes. This opinion comes from confusion between a work and its artefact: an item in a library is a particular embodiment of a work, for instance an edition with a precise date, by some publisher, with some typographical arrangement. That justifies the need to preserve it as it is, as a singular item, and not as a work (that is the immaterial content detached from its many embodiments in tangible support). Even if the work is still available in another format or revised edition, preservation of all editions is relevant for cultural heritage. Conversely, in order to replace a damaged or lost item, libraries and similar institutions could be imposed to acquire the work in general trade if it still exists in the same format and edition.

A differentiated treatment depending on the purpose pursued may be justified on that question, as it was already suggested when addressing the different purposes of the exception. As a rule, it could be proposed that when the reproduction act belongs to the key and public-interest mission of cultural heritage institutions to preserve and archive works, the market would not be best

placed to determine the modalities of the preservation for normative reasons, except if the act of reproduction harms the normal exploitation of the work.

Should the exception cover some limited activities of copying and delivering on request, it would have an adverse effect on the market for the work concerned if the copyright owners offer this work on demand. For that reason, the delivery upon request should not be admitted if the work is subject to licensing conditions that prohibit such making available. The case of format-shifting is more disputable. One could argue that libraries could shift to a digital format by acquiring on the market new digital editions of works they hold in an analogue format. Libraries would object that, in order to avoid constant format-shifting, they would need to shift the works in the most perennial format possible that might not be the format available on the market. If the format of the works offered on sale on the market promises to last, is less costly than digitisation by the library itself and has a better quality than the copy digitised from the analogue item, cultural heritage institutions will naturally acquire the works through normal trade. In the case of format-shifting, we would plead that the market would not be efficient to substitute to the decision of the libraries, archives and museums as what would be the best way to accomplish their preservation mission.

- ***born-digital works***: The need for digitization of works that have been created or first commercially exploited in a digital form appears less justified, as there is no need to preserve such works by migrating them into a digital format. However, librarians, archivists and museum curators who regularly deal with those type of works are particular aware of their peculiar 'fragility', firstly because their digital format tends to be more rapidly unreadable than analogue works, due to the rapid pace of technological change, and secondly since the digital format itself is sometimes more precarious and less reliable than the analogue. The first digital works of the 80's, like the first computer games or digital videos, are nowadays difficult to read due to the obsolescence of their format and the lack of adapted devices capable to play them. Museum of contemporary art that hold a collection of videos of that period, spend a lot of work and time to restore such material due to their very volatile medium. Preservation is hence certainly needed for born-digital works.

Besides, born-digital works will be the primary candidates for regular format-shifting and for web-harvesting (should these objectives be covered by the revised exception).

- **Acts covered by the exception**

The exception of article 5(2) c) only encompasses acts of **reproduction**. There is no need to cover any other acts. No dissemination of preserved or digitized works for other purposes should be allowed by the exception as it could impair the development of exploitation models by copyright owners themselves.

The only exceptions could be:

- the supplying of a single copy of a work to users for research and private study, as considered above;
- acts of communication that are ancillary to the act of reproduction and that do not have any independent significance (e.g. the sending of a copy to the person in charge of the digitization process);
- acts of communication based on digitized copies that are authorized by copyright law on other grounds, such as on-site consultation (see below) or circulation of a tangible digital copy to other libraries in the frame of interlibrary loans<sup>728</sup>.

---

<sup>728</sup> Interlibrary loans are excluded from the scope of exclusive lending right (see recital 10 of the Rental and Lending Directive) which means that such acts of circulation of works are outside of the scope of copyright.

A particular case could be the supply of a copy of a work once digitized to another cultural heritage institution in order to share the costs of digitization. The mutualisation of digitization efforts by the institutions concerned is recommended by the Report of the *Comité des Sages*<sup>729</sup> and by the European Council<sup>730</sup>.

In order to curb restrictive transpositions in Member States, it should be made clear that:

- **digital copying** is covered by the exception: some member States chose not to authorize digital copies of works for preservation, or to authorize them upon certain conditions. In its interpretation of copyright exceptions encompassed in the article 5 of the directive 2001/29 on copyright in the information society, the European Court of Justice has insisted on the overall objective of the directive to adapt copyright to the digital age<sup>731</sup>. Accordingly, restricting preservation of works and the exercise of the corresponding exception to analogue format only, is pointless.
- **multiple copying** is allowed: Limiting the exception, as some Member States do, to one single copy does not make sense in the digital environment where even a single act of reproduction might imply many technical copies and digitization inevitably results in multiple copies. Format-shifting will necessitate regular copying and cultural heritage institutions should be able to make as many copies as necessary in order to adapt to new formats to preserve works.

The High Level Expert Group on Digital Libraries recommends that libraries and archives were authorized to make more than one copy of works whose purpose is preservation. It also advises that institutions coordinate themselves at the European level to avoid duplication of these works and thus streamline the process<sup>732</sup>. The conclusion of the report of the *Comité des Sages* goes the same way. To facilitate the work of conservation by institutions, which often need to migrate from one format to another, it should be allowed to make multiple copies for archiving<sup>733</sup>. Nevertheless, the making of multiple copies to multiply access to them instead of purchasing duplicate copies or additional licences should not be authorised<sup>734</sup>.

The terminology of “**specific acts of reproduction**” has been construed restrictively by some Member States and creates uncertainty when more comprehensive acts of copying (for instance for format shifting) are at stake. Limitations of the format and number of the copies are also triggered by the fear of Member States not to comply with the requirement for the acts to be “specific”. A solution to provide some flexibility as to the acts of copying that are concerned, without affecting the interests of copyright owners or the normal exploitation of the work, would be to replace the “specific acts of reproduction” by “acts of reproduction necessary to their purpose”. A similar expression appears in the Belgium law. It entitles the eligible institutions to carry out any copy, to the extent it is required by the preservation or other authorized purpose, without being bound by restrictive technicalities.

Finally, a useful addition could be to explicitly define the condition of “**not aiming at direct or indirect economic or commercial advantage**” that appears in the conditions of the article 5(2) c), generally understood as applying to the eligible institutions and/or to the acts they undertake. This requirement has been taken from the directive 2006/115 on rental and lending rights. According to that directive, the absence of direct or indirect economic or commercial advantage that distinguishes lending from rental, occurs, in case of any payment when its amount does not go beyond what is necessary to cover the

<sup>729</sup> COMITÉ DES SAGES, *op. cit.*

<sup>730</sup> Council conclusions of 10 May 2012 on the digitisation and online accessibility of cultural material and digital preservation, *OJ*, C 169 of 15 June 2012.

<sup>731</sup> C.J.E.U., judgment of 4 October 2011, C-403/08 and C-429/08, *Football Association Premier League and others*, paragraphs 163-164.

<sup>732</sup> HIGH LEVEL EXPERT GROUP ON DIGITAL LIBRARIES, *op. cit.*, p. 5.

<sup>733</sup> COMITÉ DES SAGES, *op. cit.*, p. 30 and 32.

<sup>734</sup> This point is developed for the United States in THE LIBRARY OF CONGRESS NATIONAL DIGITAL INFORMATION INFRASTRUCTURE AND PRESERVATION PROGRAM e.a., *op. cit.*, p. 102-104.

operating costs of the establishment. An adapted definition could be usefully taken over in the recitals or an interpretative document of the library exception.

- **Further conditions**

The exception in article 5(2) c) of the directive does not require **fair compensation** to copyright owners but Member States, as for any exception of the directive, can decide to apply one. The need to apply a fair compensation regime does not seem justified as there appears to be no unreasonable or significant harm done to copyright owners if the authorized acts are limited to copying for preservation and archiving, even if one decides to understand it broadly and include therein reproductions for format-shifting and mass-digitization.

One further recommendation could be to get inspiration from a specific provision of Belgian copyright law that gives copyright owners **access to the copy made** by the library and archive for preservation. This solution could be particularly justified when the restoration, for instance of a movie, concerned a rare work or the last copy available. Copyright owners have an interest in getting access to the only copy available to exercise their rights, once the work has been restored,.

That solution might prove interesting when such access would be necessary for copyright and other related rights holders to exercise their rights and without prejudicing the legitimate interests of the library or archive having preserved the work. It could contribute to one objective of the preservation of cultural heritage put forward by the Council conclusions and recommendation of the Commission on digitization, i.e. the fostering of new exploitations of works. Providing access to restored copies when needed to copyright owners would help them to develop new exploitations of their works in line with such objective. Some remuneration to contribute to the efforts of digitization made by the institution concerned should be paid by copyright owners if they benefit from the preserved or restored copy.

As a conclusion, the different conditions for each possible extension of the exception could be as follows:

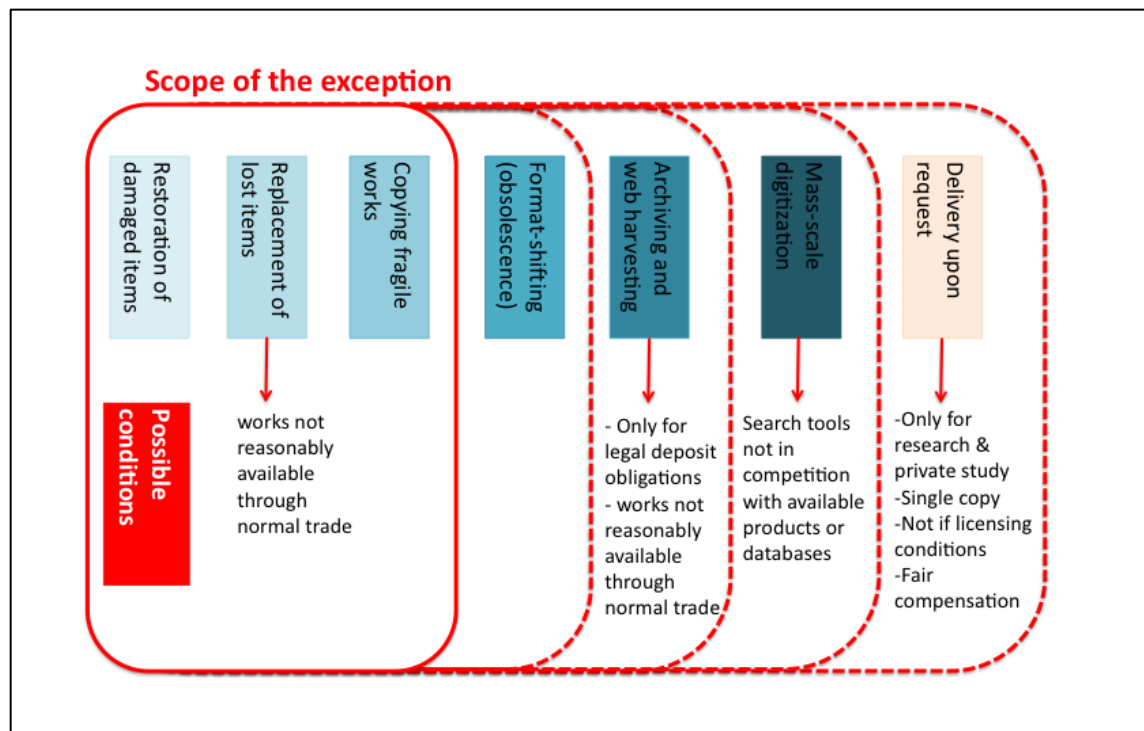

### c) Efforts towards more harmonisation in Member States

Revising the exception in the directive 2001/29 might not be sufficient. Indeed the issues for digitisation of cultural heritage did not come mostly from the directive itself but of the discretion left to Member States in its transposition and in the ensuing discrepancies in the scope of authorized acts amongst the national copyright laws. Fundamentally, the leeway felt to Member States when implementing the exception has often yielded restrictive approach that made the promises of the directive in favour of libraries rather empty or intricate to apply in practice.

Furthermore, even though the acts of reproduction undertaken by libraries to preserve and archive their collection do not have a immediate cross-border dimension, the lack of harmonisation and the differing scope of the exception from one country to the other create difficulties for libraries collaborating in European projects. This has raised uncertainties for libraries that need to ascertain the scope of what they could do in one country or the other, as well as for copyright owners who need to know what are the boundaries of their exclusive rights in each country.

The lack of harmonization of exceptions, despite the intent of the directive of 2001, has been regularly regretted or denounced<sup>735</sup>.

Working towards more harmonisation of the libraries exceptions should be done in parallel to the possible revision of the content of such exceptions

#### (i) Making the exception mandatory in the Member States

The most daring solution to increase harmonization would be to make some exceptions in the list of article 5 of the directive compulsory. This is only the case now of the exception for transient copy, provided for in article 5(1). The optional character of the exceptions has always been preferred by the European lawmaker in all copyright and related rights directives<sup>736</sup>.

Granting a mandatory nature to some exceptions could be justified on three grounds:

1° **Internal Market operation**: an exception should be mandatory for Member States when inconsistent implementation would distort and create discrepancies in the Internal Market. This does not appear to be the case, as we have seen, with the exception for libraries, archives and museums as it primarily relates to acts of copying located in one Member State. The question of the impact on the smooth functioning of the internal market seems irrelevant because works are not supposed to be communicated between Member States. Digitization for preservation – without making available – only deals with the market of a given Member State. However, different conditions for the preservation of collections from one Member State to another could create a fragmented approach in the safeguarding of European cultural heritage, which could have an indirect effect on the Internal Market for that purpose.

2° **Fundamental freedom recognised by the EU Charter on Fundamental Rights**: when the exception is grounded on the need to enable the exercise of a fundamental freedom that is part of the EU Charter, such as the freedom of expression, the freedom to information or the freedom to conduct business, it can be argued that such exception should be part of the copyright framework in all Member States. Another opinion could be that it suffices that copyright law or the judicial

---

<sup>735</sup> Amongst many others, S. DUSOLLIER, "Pruning the European intellectual property tree: in search of common principles and roots", in CH. GEIGER (ed.), *Constructing European intellectual property: achievements and new perspectives*, Cheltenham, Elgar, 2013, p. 24-57; *Study on the Implementation of Directive 2001/29/EC*, op. cit.; M.-CH. JANSSENS, "The issue of exceptions : reshaping the keys to the gates in the territory of literary, musical and artistic creation", in E. DERCLAYE (ed.), *Research handbook on the future of EU copyright*, Cheltenham, Edward Elgar Publishing, 2009, p. 332.

<sup>736</sup> B. HUGENHOLTZ ET AL., *The Recasting of Copyright...*, op. cit., p.66.

system otherwise takes the fundamental freedom into account (for instance by admitting the direct defence based on the fundamental right).

3° **European public interest** : M.C. Janssens argues that, considering that the exceptions reflect “the need and desirability for society to use a work against the impact of such a measure on the economic incentive for rightholders”, it will be necessary to support a coherent European copyright system “to (gradually) abandon the long cherished belief that the notion of what constitutes a legitimate or public interest should always accommodate national particularities”<sup>737</sup>. One could develop her argument further. Indeed exceptions convey some policy objectives that are deemed sufficiently significant to curb the exclusive rights of copyright owners. The directive, by opting for a non-mandatory list of exceptions, acknowledges the different policy objectives that Member States may desire to protect. The EU lawmaker could go a step further by acknowledging the policy objectives that, at the European level, are considered as requiring some accommodation to the normally high level of protection of copyright. The European Union has stated some key objectives that are of *European* public interest. One logical consequence would be to give the European Union the means to achieve such policy objectives by refraining Member States from deciding of the opportunity to implement an exception justified by this very public interest.

That justification to make an exception mandatory could apply in the case of article 5(2) c), as the development of digital libraries is one of the key objectives of the Digital Agenda<sup>738</sup>, and the digitization of cultural heritage is promoted by the Council and the Commission<sup>739</sup>. European institutions agree on the need to promote the Europe’s cultural heritage in the online environment. Europeana and cultural heritage institutions have a key role to play in preservation and dissemination of culture by providing access to the public, to foster the knowledge society<sup>740</sup> and contribute to the free movement of knowledge and innovation<sup>741</sup>. The enhancement of digital libraries does not necessarily mean that the copyright principles should leave the way for broad exceptions to the benefit of libraries (and policy documents dealing with digital libraries have always paid attention to develop digital libraries in full compliance with copyright law). Nonetheless, when an exception is considered as being legitimate to exempt some activities of libraries to fulfil their mission in the Information Society, it indicates at least that this exception is a means, amongst others, to achieve the mandate given to the European Union to engage in the preservation of its cultural heritage and that its implementation in Member States should be made compulsory to secure its objective at the European-wide level.

A mandatory exception allowing for acts of preservation by libraries and archive could either be precisely worded and identify all applicable requirements or could only indicate some minimal conditions in critically important areas while imposing a precisely defined objective. Mandating the transposition of the exception under already precise conditions will limit the leeway for Member States.

---

<sup>737</sup> M.-CH. JANSSENS, “The issue of exceptions : reshaping the keys to the gates in the territory of literary, musical and artistic creation”, *op. cit.*, p. 339.

<sup>738</sup> Communication from the Commission to the European Parliament, the Council, the European Economic and Social Committee and the Committee of the Regions, *a Digital Agenda for Europe*, 26.8.2010, COM(2010) 245 final/2.

<sup>739</sup> See *supra*.

<sup>740</sup> On this subject, see M.-J. IGLESIAS, “Digital Libraries: any step forward?”, *A.M.*, 2008, n° 5 ; M.-J. IGLESIAS & L. VILCHES ARMASTO, “Les bibliothèques numériques et le droit d’auteur en Europe”, *Cahiers prop. intel.*, 2007, vol. 19, n° 3 ; S. CARRIÉ, “Les bibliothèques à l’heure du numérique”, *Comm. Com. électr.*, 2006, n° 6.

<sup>741</sup> Communication from the Commission to the European Parliament, the Council, the European Economic and Social Committee and the Committee of the Regions of 20 November 2007 – A single market for 21st century Europe, COM(2007) 724 final.

### **Advantage(s)**

The key benefit of a compulsory exception is the creation of legal certainty as to what is authorized in all Member States. The interpretation of the exception and of its conditions is then left to the European Court of Justice that can develop an autonomous and uniform principle of copyright law. This process was demonstrated with the temporary copying exception that has already resulted in three decisions of the CJEU that gave an interpretation of its many conditions that is binding to the Member States. There will be no risk of different implementations in the Member States, and hence no discrimination or differentiated treatment between libraries in the Member States.

It also has the advantage of giving some weight to the clear intention of the European Union to develop digital libraries and preserve European cultural heritage, not necessarily at the expense of the protection of copyright. In fact, making the exception mandatory, with strict requirements, could equally secure the rights of copyright holders, by limiting the freedom of Member States to enact an extensive exception.

Finally, without creating a European copyright code, as recommended by some, introducing a closed list of mandatory exceptions in the directive 2001/29, would contribute to the goal of a coherent copyright system that not only harmonizes exclusive rights but also key exceptions and limitations.

### **Disadvantage(s)**

The choice for a list of compulsory exceptions within the general list of admissible exceptions would create a much-contested territory. Both users and rightholders would argue for and against the upgrading of some exceptions to the mandatory status, which would add to the complexity of copyright lawmaking. This would be a new direction in EU copyright law.

As a rule, imposing too many rules through directive runs counter to the proportionality principle or the subsidiarity principle.

#### ***(ii) An optional exception with precisely-defined conditions or objective***

Without going so far as enacting a mandatory exception, an alternative could be to adopt an optional exception with precisely defined conditions (as to the types of works, copies, purposes, as developed above) or with a prescribed objective. The harmonization effect could then be supported by a recent CJEU decision has stated that: "(...) although it is open to the Member States (...) to introduce an exception (...) into their domestic law, an interpretation according to which Member States which, exercising that option afforded to them by European Union law, have introduced an exception of that kind, are free to determine, in an un-harmonised manner, the limits thereof, (...) would be contrary to the objective of that directive (...), inasmuch as the limits of that exception could vary from one Member State to another and would therefore give rise to potential inconsistencies"<sup>742</sup>. In other words, even if Member States are free to implement an optional exception of a European directive, they are not allowed to undermine the objectives of the exception in the directive. An exception should be interpreted in a way that enables its effectiveness and the achievement of its purpose<sup>743</sup>. This teleological interpretation can prescribe to Member States to implement the exception so as to abide by the objective ascribed by the directive<sup>744</sup> and more generally to "allow and ensure the development and operation of new technologies"<sup>745</sup>. When the conditions of the exception are detailed in the directive, the discretion left to Member States is reduced accordingly. We will see further on the example of the exception for on-site

---

<sup>742</sup> C.J.E.U., judgment of 26 April 2012, C-510/10, *DR and TV2 Danmark*, paragraph 36.

<sup>743</sup> C.J.E.U., judgment of 1 December 2011, C-145/10, *Painer*, paragraph 133.

<sup>744</sup> C.J.E.U., judgment of 26 April 2012, C-510/10, *DR and TV2 Danmark*, paragraph 36.

<sup>745</sup> C.J.E.U., judgment of 4 October 2011, C-403/08 and C-429/08, *Football Association Premier League and others*, paragraph 163-164, related to the exception for temporary copying.

consultation that has generally be transposed *verbatim* by Member States, due to the precision of the directive as to the conditions of the exception.

Recitals of a revised directive or an interpretative document could then elaborate on the objective of the exception in permitting the safeguarding of European cultural heritage. This could curtail restrictive application of the exception by the Member States.

The overall objectives of the exceptions in the directive – i.e. to promote access to culture and to facilitate the internal market and the development of the information society (see above) – are already described in the recitals, but the precise objective of each exception is not clearly determined.

### **Advantage(s)**

Further clarifying the objective and scope of the exception in favour of libraries would give a general mandate for the Member States without imposing the details of the legal provision authorizing the concerned activities. That would leave some leeway to Member States which could better determine, depending on their national context, how to achieve the objective of safeguarding their cultural heritage. Harmonisation does not necessarily mean uniformity, as was pointed out by the Legal Advisory Board in an early critique of legislative precedent to the directive<sup>746</sup>. Distinctive features in national laws could then subsist if they do not hinder the operation of the internal market, which is normally not the case with acts of copying carried out within libraries.

### **Disadvantage(s)**

The explicit definition of the objective of the exception of article 5(2) c) may not be sufficient to achieve harmonization, even partially. Member States have well understood the objective pursued by the directive in that regard, though that did not prevent them from adopting very diverse exceptions for libraries, with different scope and conditions. The efficiency of the apparently simple solution mainly relies on the recent case law of the ECJ that favours a teleological approach of the exception. The court decisions in question however are triggered by questions of interpretation of an exception and of unclear conditions. It does not go so far as modifying the requirements imposed by the national law to the benefit of the exception, except in one decision where one requirement of the national law was left aside to make prevail the freedom of expression enshrined in the exception<sup>747</sup>.

## **d) Facilitating copyright clearance by libraries**

Once defined the exact scope and boundaries of the exceptions to the benefit of libraries, museum, educational establishments and archives, some activities undertaken by those institutions in their mission of preservation, archiving and keeping accessible our cultural heritage will be necessarily left outside of the exception. Cultural heritage institutions will need to get authorization from copyright owners for such activities, that may be, depending on the choice as to the extent of the exception, acts of web harvesting, mass-digitization, sending upon request or, in all probability since dissemination of works should not be exempted, making available the digitized collection online.

When accomplishing such tasks, libraries and other similar institutions face high transactions cost by reason of the number of works and rightholders concerned, the high-volume of transactions of little individual value.

The interests of the libraries could be accommodated by the European lawmaker, by having recourse to other tools than exceptions, that would help conclude such transactions between those particular users

---

<sup>746</sup> LEGAL ADVISORY BOARD, *Commentaires du Legal Advisory Board sur la Communication de la Commission du 20 novembre 1996: Suivi du Livre vert "Le droit d'auteur et les droits voisins dans la société de l'information" sous l'éclairage des travaux de la Conférence diplomatique de l'OMPI (WIPO) de décembre 1996*, [www.echo.lu/legal/fr/proprint/labcomment.html](http://www.echo.lu/legal/fr/proprint/labcomment.html), §9A.

<sup>747</sup> C.J.E.U., judgment of 1 December 2011, C-145/10, *Painer*.



and the rightholders. The recital 40 of the directive already suggests that “specific contracts or licences should be promoted which, without creating imbalances, favour such establishments and the disseminative purposes they serve”. The cultural mission of the libraries and archives was clearly seen then as a justified ground to qualify the exercise of exclusive rights and developing adapted licensing.

This section envisages initiatives that could be taken by the European Commission to help libraries and other eligible institutions to clear copyright for the uses of works that will not be governed by a revised (or not) article 5(2) c) of the directive 2001/29. It will cover successively the recourse to framework contracts, Memorandum of Understanding or other licensing agreements, compulsory collective management and extended collective licensing.

#### **(i) Encouraging Memorandum of Understanding or other arrangements between stakeholders**

The European Commission has launched diverse initiatives in the recent years to promote dialogue between stakeholders where some valuable uses of copyrighted works were not easy to clear and licensed, either due to the high volume of works, generally for little value for each transaction. Some of this initiatives related to uses of works by libraries have been addressed earlier.

**Memorandums of Understanding** are sector-specific stakeholder-driven agreements negotiated amongst organisations representing users of works on one side and publishers, authors and their collecting societies on the other. It contains the key principles that will govern the license of the envisaged use and generally encourage voluntary collective licensing.

The existing Memorandum of Understanding (MoU) concerning the use by libraries of out-of-print works has been analysed above. The European Commission has also helped to draft a Memorandum of Understanding on access to works for persons with print disabilities. The increase recourse to MoUs is justified by context where there is a need, without allowing for an exception, to achieve consensus amongst stakeholders on how to solve practical issues of copyright clearance and licensing.

**Framework contract** will provide a more detailed frame for copyright licensing as it will state the provisions of a contract that could serve as a model for the copyright license that concerned users and copyright owners could decide to enter.

In the *Licenses for Europe* initiative, the Commission has also started a dialogue between relevant stakeholders on some identified issues of copyright licensing in order to deliver “practical industry-led solutions to these issues, without prejudice to further public policy action, including legislative reform, as appropriate”<sup>748</sup>. Possible outcomes of such discussion, that includes a strand (see above) on digitization and availability of audiovisual cultural heritage, could be the collection of best practices, MoUs or framework contracts. It is too early to know the practical result of the Working Group on Audiovisual works but at mid-term, there seems already to be some consensus to work on an MoU for digitization of films that are out-of-distribution on the model of the one existing in the print sector.

The European Commission could develop further and help stakeholders to structure their dialogue by such types of framework documents, for all activities that it decides not to be included in the exception.

#### **Advantage(s)**

MoUs and other framework arrangements have the great advantage of being based on voluntary agreement stemming from all the parties concerned without any need to change the law. The MoUs promote a pragmatic approach to copyright licensing, while taking into account the specific needs of users and the mission they might assume. Its advantages are its flexibility for the right holders and users,

---

<sup>748</sup> As stated in the Communication of the Commission on Content in the Digital Single Market, 18 December 2012, COM(2012)789, p.3.

the possibility of negotiation of the terms and conditions with the libraries (that might evolve over time), as well as the absence of a choice for any particular legal system. For libraries, the *MoU* could help them accomplishing their task in the digital environment while reducing the constraints and increasing legal security as to the conditions and modalities of copyright licensing. It also decreases transaction costs, as negotiating contracts with copyright holders is framed on a commonly-agreed model. When the agreement provides that the licensing will be achieved through collective management, it helps the concerned institutions to identify the copyright owners and clear copyright through single points of contact that are the collective management organisations.

MoUs will generally be sector-specific which may better fit the concerns and needs of each creative sector. Furthermore, they ensure sufficient flexibility in the granting of the licenses.

### **Disadvantage(s)**

MoUs and other framework arrangements are generally non-binding and could not be endorsed by all stakeholders. To counter such risk, the existing MoUs at the European level have gathered around the table the most representative actors of the users and copyright owners concerned.

When the arrangement has recourse to collective management organisations, some legislative backing would be useful to ensure that all rightholders are represented by the CMO in their sector.

#### ***(ii) Compulsory collective management***

Compulsory collective management of an exclusive right limits the individual exercise of copyright by entrusting these rights by law to a collective management organisation. This is a solution that has sometimes been put forward to deal with situations where the multiplicity of works whose copyright should be cleared creates significant transaction costs and the risk not to identify all copyright owners is too high. As a consequence, libraries, museums and archives could enter in negotiations with collective management organisations to clear rights concerned by their activities of digitization and dissemination.

The French law on out-of-print-works sets up a regime of almost compulsory collective management, since authors and publishers of works that are not commercially available and who have not opt out of the system, will see their rights exercised by a CMO.

The system of compulsory collective management is a very straightforward solution but seems contradictory with the process of both MoUs and Licenses for Europe that insist on voluntary collective management (and to some extent with the process of the draft directive on collective management).

#### ***(iii) Extended collective licensing***

The mechanism of extended collective licensing comes from the Nordic countries (Denmark, Finland, Iceland, Norway, Sweden). Initially, this system is characterized by a voluntary transfer, by the right holders, of their rights to a collecting society for the licensing of the use of their works. The essential element is the voluntary membership of the right holders<sup>749</sup>. CMOs then establish contracts with end users allowing certain uses of the repertoire they make available to them. This is only in a second stage that these licensing agreements might be extended, by legislation, to all right holders of certain categories of works. The repertoire managed by the collective society is then extended to right holders who were not initially members. The only requirement is that the collecting society demonstrates its legitimacy in that it already represents a significant part of a given category of works. The extended collective license is automatically extended to all the authors in a given sector, including foreign authors, except where the law provides for a system of opt-out for authors.

---

<sup>749</sup> See TH. RIIS & J. SCHOVSBO, "Extended Collective Licenses in Action", *I.I.C.*, vol. 43, 2012, p. 930; J. AXHAMN & L. GUIBAULT, *op. cit.*, p. 30 seq.

This system is already in place for acts of mass-digitization and making available undertaken by libraries in Denmark (reproduction upon request y libraries), Finland, Norway (both countries provide ECL for reproduction and communication to the public by libraries, archives and museums), and Sweden (distribution of works to individual library patrons).

It could either be proposed to Member States as a solution for the clearance of rights for some activities of libraries not covered by an exception or be introduced at the European level as a uniform rights clearance system.

### **Advantage(s)**

This system is a sort of mandatory collective management that is imposed on non-members of a collecting society. Similarly to compulsory collective management, it helps users to get a license for a whole repertoire without the need to verify who is actually represented by the CMO concerned. An added value of the ECL is that it is triggered only when a CMO is considered as being representative of the authors in a specific sector and has already negotiated licenses for that kind of uses on their behalf.

As stated by the Hooper Report commissioned by the British Government, "ECL will appeal more in areas where licensing is characterised by high-volume, low-value transactions with high administration costs for individual clearance"<sup>750</sup>, which is the case of many uses envisaged by libraries that might not be covered by the exception. It could provide a workable solution for cultural institutions to get proper licenses covering their activities.

### **Disadvantage(s)**

This solution is typical to Nordic countries and may not be transposed easily in other legal traditions that could not be adapted to welcome such a foreign transplant. Yet, the ECL is seducing an increasing number of Member States that consider their implementation in their national copyright law. For instance the UK Intellectual Property Office recommends the solution of ECL for mass-digitization and orphan works<sup>751</sup>, as well as the Report Lescure commissioned by the French Government.

The regime of ECL presupposes a representative CMOs with good governance and transparency and that has some volume of licensing the use in question (before such licenses can be extended to non-members). The inherent problem of representativeness and of protection of the interests of non-members by the CMO concerned is particularly present for foreign authors who will be "absorbed" by the system. One significant problem with ECL is its cross-border operation. The CMOs is generally only representative of national authors<sup>752</sup> and the question of the remuneration of foreign authors for acts authorised under an ECL is still disputed.

Introducing the ECL at the European level could be seen as contradictory to the subsidiarity principle.

---

<sup>750</sup> R. HOOPER & R. LYNCH, *Copyright works. Streamlining copyright licensing for the digital age*, 2012, <http://www.ipso.gov.uk/dce-report-phase2.pdf>, §142.

<sup>751</sup> See R. HOOPER & R. LYNCH, *op. cit.*, Annex I.

<sup>752</sup> J. ROSEN, "News from the Nordic Countries", *RIDA.*, Janvier 2011, p.185.

### C. The exception for on-site consultation in libraries

The article 5(3) n) of the InfoSoc Directive authorizes Member States to provide for an exception or limitation for the “use by communication or making available, for the purpose of research or private study, to individual members of the public by dedicated terminals on the premises of establishments referred to in paragraph 2(c) of works and other subject-matter not subject to purchase or licensing terms which are contained in their collections”.

This exception has been introduced in the text of the directive at the stage of the common position, following the demand of some Member States to add to the previously limited list of exceptions of the article 5, some other uses that were either existing in their national law or considered as relevant. There is no other indication in the preparatory acts as to the rationale of the exception.

This exception aims at enabling consultation of works in a digital format<sup>753</sup> on specific equipment under similar conditions to the browsing of a book in a library. It will generally imply a first act of digitization of the work in order to make possible its consultation on dedicated devices. During that process, search capacities could be added to the digitised work to help the research and consultation by end-users. The evolution of digital practices and the virtual abolition of the distance between users and content, wherever the latter is kept, have generated an increasing number of requests from users and researchers to be able to consult the collection of libraries at distance. The exception of article 5(3) n) was not aimed at making the items of a library accessible online. The key issue, should the lawmaker consider the exception outdated and in need of adaptation to broader possibilities of consultation, would be to determine the scope of the notion of “on-site consultation”. The existing exception is limited by spatial and technical restrictions, for the consultation should occur on the physical premises and through dedicated terminals. If one wishes to abolish those walls (of the library and of the equipment), the question is what should be the proper boundaries of place and means where the consultation can take place.

This part will assess whether the scope of this exception has not become too narrow in the context of technological changes and examine whether the restrictive nature of the permitted consultations (research or private study) of digital archives should not be updated<sup>754</sup>.

To this end, the notion and scope of the on-site consultation exception in the directive will first be analysed (1.). Then, the national implementations of the exception in Member States will be described (2.). This will enable the assessment of the exception and the possible issues and uncertainties it raises (3.). Finally, some recommendations will be made (4.).

#### 1. Scope of the exception in the directive

##### a) Objectives

Contrary to the exception benefitting the libraries by virtue of article 5(2) c) of the directive, the objective of the acts authorised by the article 5(3) n) is clearly and strictly stated. The making available of works by libraries for consultation on their premises should be limited to research and private study.

---

<sup>753</sup> The consultation could also occur in analogue format, even though the digital form has now substituted the analogue one. A former example would be the shifting of some books or reviews on microfilms, viewable on specific equipment.

<sup>754</sup> We refer to the Annex A (Task Specifications, Study on the application of directive 2001/29/EC on copyright and related rights in the information society (the “Infosoc Directive”) of the *Specific Contract: Markt/2012/013/D1/ST/SC implementing Framework Contract No PN/2009-35 D* between the Commission of the European Communities and De Wolf& Partners.

Nothing in the adoption process of the directive or in the preparatory acts define the notions of “research” or “private study”.

Contrary to the exception for teaching and scientific research (see *infra*), **research** is not accompanied by the requirement of “scientific”, but should nevertheless exclude research for commercial purposes<sup>755</sup>.

Excluding research for commercial purposes would normally preclude consultation in libraries undertaken for professional purposes, such as lawyers consulting law reviews articles within a library to prepare a case<sup>756</sup>. The commercial purpose should however be reasonably interpreted. A researcher in a university still does non-commercial research even if it results in a publication of a book (that could maybe yield some revenue)<sup>757</sup>.

**Private study** could be defined as “study which is not done directly or indirectly for a commercial purpose”<sup>758</sup> but should aim at exploration and acquisition of knowledge and not merely at entertainment<sup>759</sup>.

## b) Beneficiaries

The act of consultation should take place on the premises of the institutions referred to in article 5(2) c), i.e. publicly accessible libraries, educational establishments, museums and archives. Those institutions are the beneficiaries of the exception and are authorised to make works available for the purpose of research and private study. What has been said earlier in the frame of the analysis of the exception for some acts of reproduction can be summarized here.

The institutions covered encompass libraries, educational establishments, museums and archives that are not further defined by the directive. Amongst those institutions, libraries and archives are likely to offer for consultation some parts of their collections. It might be less frequent in museums and educational establishments.

The eligible institutions should be **publicly accessible**, at the exception of archives as we have seen above. This requirement means that the access to libraries, museums and educational establishments is allowed to the general public without discrimination. It does not require regular opening hours or ban conditions for access (as the payment of a fee or a registration as a student for instance).

The second condition is the **non-profit nature** of the institutions concerned. This is referred to in article 5(2) c) as the requirement that those establishments are “not for direct or indirect economic or commercial advantage”. This does not amount to a public nature of the institutions. Privately funded or operated libraries would be eligible if their activities do not aim at making a profit. Requiring some fee to enter or consult the collection is also admissible if it does not exceed the costs incurred by the library or archive.

---

<sup>755</sup> M WALTER & S. VON LEWINSKI, *op. cit.*, n° 11.5.70. One decision from the Canadian Supreme Court explains that the word “research” has to be interpreted broadly, including “conducting research to identify which music to purchase” and that “research” need not be for creative purposes only. (*Society of Composers, Authors and Music Publishers of Canada v. Bell Canada*, 2012 SCC 36, [2012] 2 S.C.R. 326, 12 July 2012). Such an interpretation might in our view, prove too broad for the exception enabling making available for on-site consultation, as it would include almost any act of exploration of content.

<sup>756</sup> M.-CH. JANSSENS, “De uitzonderingen op het auteursrecht anno 2005 – Een eerste analyse”, *A.M.*, 2005, p. 504.

<sup>757</sup> *Contra*, E. DERCLAYE, “Of Maps, Crown Copyright, Research and the Environment”, *E.I.P.R.*, 2008, n° 4, p. 163.

<sup>758</sup> E. DERCLAYE, “La transposition de la directive “droit d’auteur dans la société de l’information” au Royaume-Uni. Quelques aspects relatifs aux droits et aux exceptions”, *Propr. intell.*, 2004, n° 11, p. 604, who refers to article 178 in the UK legislation.

<sup>759</sup> M WALTER & S. VON LEWINSKI, *op. cit.*, n° 11.5.70.

### c) Works concerned

The exception is not restricted to some categories of works. There is no limitation either as to the quantity of works (such as extracts or small parts) that can be subject to consultation.

Two conditions pertain to the object of consultation though. Firstly, the works that could be offered for viewing on-site, should be **contained in the collections** of the libraries, educational establishments, archives and museums concerned. Therefore, on-line viewing of library's collection on another library's premises is not covered<sup>760</sup>. But that also seems to prevent those institutions from putting on consultation terminals works they have temporarily borrowed or received from other institutions or persons or to link those terminals to webpages where works could be consulted.

The second condition excludes from the benefit of the exception **works that are subject to purchase or licensing terms**. The objective is to enable the rights holders to conclude contracts with libraries to determine the conditions for such on-site consultation, which could be particularly relevant for some scientific works whose presentation or business model includes viewing and searching capabilities. This condition also means that the exception can be contracted out.

The interpretation of the scope of this requirement is however not easy, as demonstrated by the recent referral to the European Court of Justice by the German Federal Court of Justice in a case involving the Technische Universität Darmstadt<sup>761</sup>. The university library had digitized one book about Modern History to make it available on electronic readings points, whereas the publisher of the book proposed to the library to purchase e-books of the textbooks it published, including the book in question. That offer was not taken up by the library.

Amongst the questions referred to the European Court, the exact scope and meaning of the condition of "works not being subject to purchase or licensing terms": does it include an offer by the rightholder to conclude licensing agreements?

A broad construction of the condition would exclude the application of the exception as soon as the work is available on the market for purchase or licensing under terms that prohibit the on-site consultation by libraries<sup>762</sup>. In other words, if a work is "offered for sale or can be licensed on the market"<sup>763</sup>, the exception does not apply. That would prevent libraries to make available on their terminals digitized copies of works they hold in their collections, if the same work is now available in a licensed version governing such making available.

A more restrictive approach would consist in interpreting the condition as meaning that the library should not be bound by a specific contract that prohibits or regulates making a work available for on-site consultation. Only a contract actually agreed upon with the library would override the exception, not the mere offer to contract.

The *Technische Universität Darmstadt* case lies in the middle as it is not the mere availability of the textbook in an electronic format subject to licensing terms that bothers the German court but the existence of a specific offer made to the library to purchase that electronic copy and to enter in a contractual relationship with the rightholder.

The reading of the directive does not offer much guidance and the different linguistic versions are open to similar ambiguity ('non soggetti a vincoli di vendita o di licenza', 'non soumis à des conditions en matière d'achat ou de licence' in French, 'que no son objecto de condiciones de adquisicion o de licencia' in

---

<sup>760</sup> S. BECHTOLD, *op. cit.*, p. 381.

<sup>761</sup> Request for a preliminary ruling by the Bundesgerichtshof, 14 March 2013, C.J.E.U., pending case, C-117/13, *Technische Universität Darmstadt*, question 1.

<sup>762</sup> M WALTER & S. VON LEWINSKI, *op. cit.*, n° 11.5.39.

<sup>763</sup> S. BECHTOLD, *op. cit.*, p. 343, esp. 381.

Spanish', 'für die keine Regelungen über Verkauf und Lizenzen gelten' in German). The Dutch version appears to include a mere offer to purchase a work, by referring to "werken die niet te koop worden aangeboden of aan licentievoorwaarden zijn onderworpen (that can be translated by works not *offered* for sale or not subject to licensing terms).

The most restrictive approach is nothing else than a repetition of the contractual prohibition applicable to the libraries (and the statement that this exception can be contracted out). The other interpretation leaves more leeway to copyright owners to develop business models enabling consultation of their works on the premises of libraries which can be an important development for works likely to be often viewed for research or private study purposes, such as textbooks, newspapers or other scientific works. However, it would mean that the benefit of the exception would depend on changes of exploitation models decided by the rightholder. The making available of one work by a library for consultation purpose could suddenly not be legitimate anymore if the publisher decides to release an electronic version subject to unilaterally decided license terms. In other words, is a mere offer from the rightholder sufficient to rule out the exception of article 5(3) n) ?

The German *Bundesgerichtshof*, in its referral to the CJEU, argues in favour of the broader position on the ground that copyright owners should not be refrained from granting the user the rights on appropriate terms. The principle of the directive for a high protection of copyright also inclines to agree with that position. The question is now left for the CJEU to decide.

A last point worth mentioning is the fact that databases and software are not subject to the limitation as exceptions to such subject-matter are dealt with in other directives. As to **computer programs**, their on-site consultation does not make much sense, except once again for computer games. Indeed, specialized archives or museums have no other means to provide consultation of those particular cultural items for research or private viewing than installing and making them available on devices within their premises. No exception authorizes such making available in the directive 2009/24 on the legal protection of computer programs<sup>764</sup>.

No exception would apply to the making available of **databases** for on-site consultation. The consultation of databases on dedicated terminals is certainly important for libraries, but the acquisition of databases by libraries and the rights of using them will generally be subject to licensing conditions. Such consultation also forms a core element of the exploitation of the types of databases (generally scientific databases) that are likely to be significant for libraries and should hence not be allowed by an exception.

## d) Authorised acts

### (i) *The explicit limitations of the exception*

The directive allows the use by **communication or making available**.

Such communication should be restricted to individual members of the public. The exception does not allow the communication directed towards the general public or to a gathered audience<sup>765</sup>. One can wonder whether the making available of some works contained in the collection of a museum to visitors qualifies as a communication to individual members of the public. For instance a film museum could provide extracts of films to illustrate the history of cinema on specific terminals along the visit of the collection, as it might not be directed to individual members of the public. It will depend on the circumstances of the making available and of the purpose thereof (that should remain research or private study to be admissible). If the works are viewable as public performances, the exception would certainly

<sup>764</sup> The exception of article 5(3) n) could however be applied to the video game as to its graphic element, in conformity of the decision of the CJEU in the *BSA* case that decided for a distributive application of the directive 2001/29 to non-literary elements of the software and of the specific directive 2009/24 to the code or literary elements.

<sup>765</sup> M WALTER & S. VON LEWINSKI, *op. cit.*, n° 11.5.3 ; S. BECHTOLD, *op. cit.*, p. 343, esp. 381.

not apply, but if they are at disposal for individual visitors wishing to know more about the topic of exhibition, the exception might in our view be admitted. In some cases, the exception of quotation could subsidiarily apply to the showing of film extracts to illustrate the exhibition of the museum<sup>766</sup>.

The communication that is authorised by the directive is limited in two respects. It has to happen through dedicated terminals and on the premises of the eligible establishment. The first limitation (by **dedicated terminals**) is technical and refers to specific equipment. That could be the case if the work is made available for consultation on a format that requires a specific reading device (for instance, microfilms or projectors capable to play old film formats). However, the convergence of formats enabled by the digital evolution would allow that standard computers, audio and video terminals accessible to individual users of institutions, are covered by the exception, to the extent that their use is reserved by the library to a consultation function<sup>767</sup>. Usually the terminals provided by the libraries to view some specific works, also enables other functions such as research within the catalogue or on the Internet. It seems reasonable not to exclude such terminals from the benefit of the exception, even if the directive does not solve the question<sup>768</sup>. On the contrary, extending the provision to the personal computers used by the users themselves to get access to the works on the website of the library would be contrary to the exception, in its current wording. The recent ECJ case law that opened the interpretation of exceptions to a teleological approach in order to enable the purpose of the exception (in this case the consultation of the work on the premises of the library) could however provide for more flexibility.

The limitation to dedicated terminals can also be understood as pursuing a security objective. It aims at ensuring that the consultation is limited to that device and could not extend the access to works it provides to users beyond mere consultation. This objective appears in the recent reference for preliminary ruling to the CJEU, in the question related to the possibility for the user to print the consulted work or make a copy thereof on an USB key, a question we will analyse in the next point. Some libraries disable the copying functions of the terminals or computers they provide for consultation of their collections or parts thereof to limit them strictly to consultation purposes.

The second limitation, i.e. the **premises of the establishment**, is a spatial restriction. The English terminology of “premises” can either refer to the building occupied by the library, archive or museum (which results from the Dutch version using ‘gebouwen’), or to a more locally restrained notion of rooms or spaces occupied by the library or archive itself, which appears more clearly in other languages of the directive (‘locali’ in Italian, ‘locaux’ in French, ‘locales’ in Spanish, ‘Räumlichkeiten’ in German). This subtle difference of interpretation could have significance in the case of a library hosted by a research or education institution. Should the terminals dedicated to on-site consultation be placed within the library itself or could they also be provided in other places of the institutions, hence enabling a remote consultation within the building? The requirement of dedicated terminals restrains in any case this possibility. Under the current formulation of the directive it does not seem possible for researchers within a university to consult works made available by the university library remotely from their offices<sup>769</sup>.

The conjunction of those two requirements restricts the consultation to the location of the library, educational establishment, museum or archive and does not completely abolish the distance between the

---

<sup>766</sup> On the condition that the quotation exception allows for other purposes than criticism or review that are not exhaustive in the article 5(3) d) of the directive.

<sup>767</sup> S. BECHTOLD, *op. cit.*, p. 343, esp. 381.

<sup>768</sup> M. BUYDENS, “La nouvelle directive du 22 mai 2001 sur l’harmonisation de certains aspects du droit d’auteur et des droits voisins dans la société de l’information : le régime des exceptions”, *op. cit.*, p. 429, n° 24.

<sup>769</sup> S. DUSOLLIER, “Droit d’auteur et bibliothèques dans l’univers numérique”, *R.D.T.I.*, 2002, n°12, p. 84-85; M.-CH. JANSSENS, “De uitzonderingen op het auteursrecht anno 2005 – Een eerste analyse”, *op. cit.*, p. 504.



work held by the latter and the reader<sup>770</sup>. The exception does not in any way enable a completely remote consultation of the collections of cultural heritage institutions<sup>771</sup>.

It also raises a difficulty to centralized libraries with some delocalised services. This happens often in geographically large countries that entrust the national library, usually located in the capital, with the legal deposit, but organise delocalised libraries in other important cities<sup>772</sup>. At first sight, the current notion of “on the premises” contained in the article 5(3) n) does not allow the central library to make works of its collection available to researchers or other uses requesting access thereto in a local section of the library, except under a teleological interpretation that seems more reasonable.

### **(ii) Unsolved questions**

The article 5(3) n) itself does not mention **acts of reproduction** which begs the question as to whether the beneficiaries of the exception can digitise works they hold in order to make them available under the conditions of the exception. This question is also referred to the European Court of the Justice in the *Technische Universität Darmstadt* case.

Two responses can be formulated. Such digitization could be allowed under the reproduction exception for preservation. In such a case, the legitimacy of the act of reproduction would depend on the notion of preservation applicable to the article 5(2) c).

Another ground to admit the act of digitization preliminary to the making available for consultation could be its ancillary nature, as transferring the work in a digital format will often be necessary to enable its consultation on dedicated terminals.

This is the position adopted by the German Federal Court in its referral to the Court of European Union. It explains that “the effectiveness of the provision would not be safeguarded if libraries were not permitted to digitise the printed works they held in order to make them available on terminals, but were instead required to purchase an equivalent number of digital reproductions”<sup>773</sup>.

Another question referred to the Court is whether the article 5(3) n) of Directive 2001/29/EC goes so far as to enable users of the terminals to print out on paper or store on a USB stick the works made available there. Those acts exceed the making available by libraries but could define the extent of the possibilities offered by those institutions to users under the exception. They also indicate the boundaries of the consultation for research or private study if it can result in the users getting a copy of the work, at the detriment of the normal exploitation of the work. The German referring court distinguishes between the printing out and the copying on an USB stick. The first one would amount to an act of private copy of reprography if limited to the personal use of the library patron<sup>774</sup>, but the referring decision admits that the exception is limited to dedicated reading workplaces that normally would not permit printing. Nevertheless, the federal court considers that “in today’s world academic work with texts is generally practically possible only if important passages of a text can be marked and annotated and the relevant extracts can be taken from the library for further study. (...) Therefore, in order to work meaningfully with the texts communicated or made available on terminals for the purpose of research and private study it must be possible to print out and work on the texts concerned”<sup>775</sup>.

---

<sup>770</sup> F. STASSE, *op. cit.*, p. 6.

<sup>771</sup> S. BECHTOLD, *op. cit.*, p. 343, esp. 381.

<sup>772</sup> M. CORNU, “L'accès aux archives et le droit d'auteur”, *R.I.D.A.*, 2003, n°195, p. 41.

<sup>773</sup> Request for a preliminary ruling by the Bundesgerichtshof, 14 March 2013, C.J.E.U., pending case, C-117/13, *Technische Universität Darmstadt*, paragraph 22.

<sup>774</sup> *Ibidem*, paragraph 26.

<sup>775</sup> *Ibidem*, paragraph 29-30.

The same is not true with the digital storing of consulted works on a USB key, that is not essential to academic research and would conflict with the normal exploitation of the work<sup>776</sup>.

A last question concerns the multiplicity of access rendered possible by the making available on dedicated terminal. The directive does not appear to limit the number of copies that could be installed for consultation of reading workplaces, or the number of simultaneous access. The fact that the work should be in the collection of the library does not necessarily imply that the number of access should equal the number of copies owned by the libraries.

### **e) Further restrictions**

The directive does not impose any further conditions, and is not accompanied by the obligation of fair compensation to be paid to rightholders. As for the exception of article 5(2) c), that does not prevent Member States to apply some scheme of compensation based on the possible harm caused to the rightholders.

### **f) Concerned users**

As indicated before, the making available of the work is reserved to individual members of the public for the purpose of research or private study.

## **2. Implementation of the exception in the Member States**

The exception for on-site consultation has not been transposed in 9 Member States<sup>777</sup>. Amongst the countries we have analysed, the United Kingdom does not know any exception enabling the making available of works for consultation on the premises of libraries and archives, but the current process of revising the exceptions intends to add a new provision in the *Copyright, Designs and Patent Act* for that purpose.

The countries having enacted the exception have generally implemented in a way that is identical or very close to the text of the directive.

### **a) Objectives**

The purpose of research and private study has been literally taken over in Belgium, France, Germany, Hungary, Italy, Luxemburg, the Netherlands.

Similar purposes such as personal viewing or study in Denmark<sup>778</sup>, research or learning in Poland<sup>779</sup>. Spain only mentions research as the purpose of this exception.

None of those countries further define the 'research' or 'private study', but the UK draft for a new exception limits its purpose to non-commercial research or private study.

The Luxemburg adds to the literal transposition of article 5(3) n) the communication of audiovisual works within film archives with the objective of promoting the film cultural heritage<sup>780</sup>.

---

<sup>776</sup> *Ibidem*, paragraph 36.

<sup>777</sup> According to the first report on the evaluation of the directive 2001/29, Austria, Cyprus, the Czech Republic, Greece, Ireland, Latvia, Slovenia, Sweden and the UK have not transposed the article 5(3) n) of the directive.

<sup>778</sup> Article 16a, (1) of the Danish Consolidated Act No. 202 of 27 February 2010 on Copyright.

<sup>779</sup> Article 28, (3) of the Polish Law No. 83 of 4 February 1994 on Copyright and Neighbouring Rights.

## b) Beneficiaries

The directive aligns the beneficiaries of the exception for on-site consultation on those enumerated in the article 5(2) c) for certain acts of reproduction. This parallelism appears also in the national implementations of the exception.

The exception benefits to libraries, educational establishments, museums and archives in Belgium (where educational establishments is extended to teaching and scientific establishments), in Denmark<sup>781</sup>, Hungary, Italy, Luxemburg, Spain<sup>782</sup>, as well as in the draft text revising the UK Copyright law.

Educational establishments are not listed in France, Germany, the Netherlands, and museums are missing in Poland (that includes libraries, archives and schools). In France, the law related to the legal deposit of 1992 has been amended to implement the article 5(3) n of the directive and to allow the consultation of collections on the premises of the libraries in charge of such legal deposit.

All relevant national provisions require that the beneficiaries do not search **direct or indirect commercial or economic advantage**, at the exception of Denmark (that requires though that the beneficiaries are financed in whole or in part by the public authorities), Italy and Poland. One can think that this limitation is implicit in those countries. Hungary explicitly states that the displaying and the communication should not be intended for earning or increasing income even in an indirect way.

## c) Works concerned

The national copyright laws generally apply the exception to all categories of works. The Netherlands only mentions literary, scientific or artistic work, which seems to exclude sound and audiovisual works.

Most countries repeat the requirement laid down in the directive according to which the work must be in the collection of the library or similar establishment.

All national laws, but France and Poland, exclude the application of the authorized use when the work is subject to purchase or licensing terms. Those terms are not more defined than in the directive. The Netherlands replaces the formulation of the directive by “unless otherwise agreed”.

Finally, Denmark and Germany impose that the work be published to allow for the exception. A similar requirement appears in France, Luxembourg and Belgium in a general provision applicable to all exceptions to copyright and related rights<sup>783</sup>. The draft revision of the Copyright Act in the United Kingdom would require that the work be lawfully acquired.

## d) Authorised acts

Usually the communication and making available are covered by the exception (with slight deviations such as display in Poland). In France the exception is merged with that authorizing libraries, museums and archives to undertake acts of reproduction or communication for preservation purposes. A second objective of enabling on-site consultation appears in the same provision<sup>784</sup>.

<sup>780</sup> Article 10, 10° of the Luxemburg Law of 18 April 2001 on Copyrights, Neighbouring Rights and Databases.

<sup>781</sup> The establishments concerned are more precisely defined, see article 16a (1) and (3) of the Danish Consolidated Act No. 202 of 27 February 2010 on Copyright.

<sup>782</sup> The list of beneficiaries in Spain includes museums, archives, libraries, newspapers libraries, record libraries or film libraries in public ownership or belonging to institutions of general cultural, scientific or educational interest, or teaching institutions.

<sup>783</sup> See *supra*.

<sup>784</sup> See article L.122-5, 8° of the French Intellectual Property Code of 1 July 1992.

As said above, France<sup>785</sup> also allows the reproduction of works to the extent necessary for the consultation for purposes of research or private study.

The on-site condition has been implemented sometimes by using different terminology but with the same result than the directive. As to the definition of the **equipment** through which the communication can occur, France<sup>786</sup>, Germany<sup>787</sup>, Italy<sup>788</sup> refers to *dedicated terminals* as in the Directive (as does the UK draft revising the copyright exceptions), whereas other Member States use the terminology of *special terminals* (Belgium<sup>789</sup>), *technical equipment* (Denmark<sup>790</sup>), the screens of dedicated terminals (Hungary), *information technology system terminals* (Poland<sup>791</sup>) or add a requirement of communication through *closed network* (the Netherlands<sup>792</sup>) or *closed and internal network* (Spain<sup>793</sup>) to the condition of dedicated terminals. The French legal provision on legal deposit, that doubles the copyright exception for on-site consultation, refers to individual consultation posts whose use is exclusively reserved to researchers<sup>794</sup>.

Concerning the **premises**, this spatial limitation appears in all legislations but the Netherlands that mentions the buildings of the institutions ('gebouwen'), which could be construed more broadly.

### e) Further restrictions

In addition, the payment of an equitable remuneration is required in Germany<sup>795</sup> and Spain<sup>796</sup>.

Germany also adds conditions related to the number of copies made simultaneously available that cannot exceed the number of copies of the works owned by the institution.

### f) Concerned users

As the Member States usually take over the purpose of research and private study and the communication to individuals, there is no need to further specify the final beneficiary of the making available. One notable exception is the French law on legal deposit that requires, for consultation of works organised by the institutions in charge of the legal deposit, that the communication be only addressed to accredited researchers<sup>797</sup>.

---

<sup>785</sup> Article L122-5, subparagraph 1, 8° of the French Intellectual Property Code of 1 July 1992.

<sup>786</sup> Article L122-5, subparagraph 1, 8° of the French Intellectual Property Code of 1 July 1992. About the organization in charge of the legal deposit, see also L132-4 of the Heritage Code.

<sup>787</sup> Article 52b of the German Act of 9 September 1965 on Copyright and Related Rights.

<sup>788</sup> Article 71 *ter* of the Italian Law No. 633 of 22 April 1941 for the Protection of the Copyright and the Other Related Rights to its Exercise.

<sup>789</sup> Article 22, §1, 9° of the Belgian Law of 30 June 1994 related to Copyright and Neighbouring Rights. The special terminals are the means to communicate and make available works, which are accessible on the premises of publicly accessible libraries, teaching and scientific establishments, museums or archives which search no direct or indirect commercial or economic advantage.

<sup>790</sup> Article 16a, (1) of the Danish Consolidated Act No. 202 of 27 February 2010 on Copyright.

<sup>791</sup> Article 28, (3) of the Polish Law No. 83 of 4 February 1994 on Copyright and Neighbouring Rights.

<sup>792</sup> Article 15h of the Dutch Law containing New Regulation of Copyright of 23 September 1912.

<sup>793</sup> Article 37, (3) of the Spanish Consolidated Text of 1 April 1996 on Intellectual Property.

<sup>794</sup> Article L. 132-4 of the Heritage Code.

<sup>795</sup> Article 52b of the German Act of 9 September 1965 on Copyright and Related Rights.

<sup>796</sup> Article 37(3) of the Spanish Consolidated Text of 1 April 1996 on Intellectual Property.

<sup>797</sup> Article L. 132-4 of the Heritage Code. On the conditions of accreditation, see V. GAME, S. SEPETJAN, E. GRAFF, "Fasc. 1085 : Cadre administratif et juridique. Dépôt légal", *JurisClasseur Propriété littéraire et artistique*, Paris, LexisNexis, 2010, n° 127.

### 3. Assessment of the exception – Issues and uncertainties

#### a) Assessment of the adequacy of the exception in the directive

The exception for on-the-spot consultation of works in the directive 2001/29 is limited in different ways with a twofold objective: on one hand the models for consultation decided by the copyright owners will prevail on the exception by means of the limitation to work not subject to licensing terms; on the other hand, the making available will be kept in a closed environment, both by the terminals and in the location in which it can occur.

As to the **exclusion of works subject to licensing terms**, it does not seem unreasonable as it accommodates the development of business models by publishers to offer adapted products for such searching and consultation, which is part of the normal exploitation of scientific books. The article 5(3) n) of the directive has chosen that the exception is only subsidiary to the development of a market organising the provision of consultable works to libraries. The provision by the publisher of an electronic version of some works with embedded consultation possibilities and licensing terms authorizing libraries to install those searchable and viewable versions should then prohibit the beneficiaries of the exception to bypass the works available on the market to such end.

The extent of the market prevalence is the only matter left for discussion, as already indicated by the questions referred to the Court of justice for interpretation. Is it enough for copyright owners to offer some works with purchase or licensing conditions that prevent or govern on-site consultation or should the library be a party to such a contract for the works it has purchased or acquired? One should wait the answer of the Court to that question. In our view, a high protection of copyright owners and the principle of strict interpretation of exceptions would tilt towards an interpretation that authorises the exception only if the eligible institutions cannot acquire in trade, when reasonably possible, the copies of works enabling such consultation upon conditions determined by the rights owners. Otherwise, the library could rely on a digitised copy of a work it previously held in its collection not to buy the new digital products provided by publishers for the purpose of consultation. However, it could be discussed whether the restriction to works not subject to licensing terms also pertain to material whose license merely prohibits any use, without organising the conditions for making available for viewing for research purposes. In such a case, the copyright owners would have the power to block any act of consultation of the work without providing an alternative.

The **spatial and technical limitation to the premises of the institutions and dedicated terminals** is more contested. It has often been pleaded that the requirement of 'dedicated terminals' is outdated and too narrow and does not grant enough leeway to libraries in providing services to their patrons<sup>798</sup>. EBLIDA, the European Association of Libraries, argues that "it keeps the serious study and enjoyment of European Culture firmly within the technological constraints of the 20th century"<sup>799</sup>. The arguments in favour of this position are indeed the technological evolution and the ensuing convergence in equipments and formats. Viewing some digital works does not have any longer to be done on adapted devices but can be undertaken by anyone using a digital device such as a computer, tablet or even a smartphone. Whereas, at the time of the adoption of the directive, on-site consultation was considered as being a peripheral service offered by the libraries for some specific works whose digital browsing was preferred (namely to preserve the analogue copy or answer to needs for frequent consultation by users), libraries' users and researchers are now accustomed to view research or study material in a digital format and on the screens of their computers and expect to be able to do the same in a library or archive. They also claim that they should be entitled to consult the works made available by their libraries from their offices or at distance through a secured connection.

---

<sup>798</sup> Study on the Implementation and Effect in Member States' Laws of Directive 2001/29/EC, *op. cit.*, p. 56.

<sup>799</sup> EBLIDA, *Response to the European Commission's Green Paper on the online distribution of audiovisual works in the European Union: opportunities and challenges towards a digital single market*, 2011, [www.eblida.org/News/newsitem\\_6\\_2011.pdf?PHPSESSID=2614e4b194a12ac6e7c20f72c0b27f41](http://www.eblida.org/News/newsitem_6_2011.pdf?PHPSESSID=2614e4b194a12ac6e7c20f72c0b27f41), p. 3.

## b) National transpositions

The national transpositions are not more restrictive than the directive. The level of discrepancies amongst the Member States is also rather minimal, as most of them have literally transposed the exception, differences between the national versions of the exception being almost inexistent or irrelevant. Besides, the on-site consultation, to the extent it remains defined by a spatial criteria is localised on the specific institution and does not take on a cross-border dimension.

Therefore, the only issue that may be found in the exceptions provided at the national level for on-site consultation of works is identical to that addressed to the directive itself and lies in the technical limitation of the consultation to dedicated terminals.

There is normally no cross-border issue as the exception is limited to the physical premises of the library making the works available. As a principle, the benefit of exception does not have cross-border dimension. Libraries will be subject to the national law of the country in which they are located.

## 4. Possible options

The assessment of the exception for on-site consultation in the directive and in its national transposition has revealed some narrowness of the authorised acts that could only take place in a spatially and technically closed environment. Researchers complain that libraries (mostly of scientific libraries and archives) do not provide them with less restricted conditions of access to the works for research purposes. The criterion of licensing condition that excludes the application of the exception would also merit some clarification.

As for the previous exception, some possible initiatives will be now addressed and will focus on the twofold restriction related to dedicated terminals and physical premises of the library.

We will start by laying down the different factors and principles that should be weighed in the balance in devising the proper scope of the exception (a.). The second step will be to analyze the option of revising the exception in the directive by deleting the requirement of dedicated terminals (b.).

There is no need to enhance the harmonisation of the exception amongst the Member States as no significant discrepancies have been identified. It is neither justified to make it mandatory, for the same reason. There would be no sufficient ground for such a mandatory character, as the exception does not have an effect on the internal market if it is still confined within the premises of the library and is not justified by a fundamental freedom or European public interest<sup>800</sup>. However, the exception could well have some cross border effect in the future if it is revised or interpreted to allow for online viewing and consultation.

In the case of the exception for certain acts of reproduction, we have explored some means to facilitate copyright clearance by libraries for acts that would remain outside of the scope of the exception. This is not necessary in our view for consultation of works on the premises of the institution, for the exception already allows for licensing solutions if decided by copyright owners for some works. Making available works for consultation has not the same scope that mass-scale digitization and is not marked by the same high transaction costs (which was one of the reasons of facilitating licensing in case of mass-scale digitisation). Individual clearance and licensing is certainly easier to achieve which reduces the value of collective agreements such as Memorandums of Understanding or extended collective management. Larger projects of online communication of works exceed the objective exception but could fall in the solutions already provided for orphan works (specific exception allowing the making available) and out-of-print works (Memorandum of Understanding in favour of a collective management).

---

<sup>800</sup> See *supra* the discussion on the justifications to confer a mandatory character to an exception.

### **a) Overarching principles and weighing factors**

The factors to be considered to assess the need to revise the exception could be taken over from the exception for preservation purposes, though with some qualifications. If the objective of the exception can be opposed to the need to secure a high level of protection of copyright and related rights, it will not have the same weight than the objective of preservation of cultural heritage that is part of the political and cultural agenda of the European Union, as expressed in many policy documents. The exception for on-site consultation serves libraries in accomplishing their public-interest mission of making their collections available for research and private study and helps the development of effective digital libraries but is not considered as a fundamental objective for the European Union. Therefore, one could say that the interest and objective pursued by exception for onsite consultation do not significantly outweigh the interests and rights of copyright owners.

In the current exception the balance has already been tilted in favour of the rights of copyright owners, entitled to preclude the exception by offering licensing conditions to govern such making available. The models of exploitation that include possibilities for on-site consultation thus prevail over the exemption offered to libraries and archives. That indicates that this exception has been considered as a case of market failure: copyright owners regain their exclusive rights if they are able to propose some license covering the use by the eligible institution. Therefore, the reasoning is radically different than for the exception for preservation and would more easily welcome the intervention of the market when possible.

### **b) Revising the scope of the exception**

#### ***(i) The need to revise the exception or to maintain the status quo***

The exception provided for by article 5(3) n) does not present the same difficulties than the article for preservation activities of cultural heritage institutions. Its beneficiaries complain of the narrowness of the exception, particularly of the requirement to make works available only on dedicated terminals that contradict the customary use of personal equipment by researchers and library users.

Revising the directive would focus on the suppression or adaptation of that requirement, but could eventually challenge the notion of “premises” that will remain a limiting element of the exception. The other uncertainties of the exception will soon be lifted by the European Court of Justice to which a series of questions has been referred on the interpretation of the exception.

Besides, the possibility to consult works within a library is possible in most Member States. Compared to the article 5(2) c) that did not cover key new activities of digital libraries, that were urged by the European institutions to contribute to the preservation of European cultural heritage, the exception lacks the emergency or public interest that characterised the digital preservation of libraries and archives' collections.

All those reasons could plead for a status quo while waiting for the forthcoming decision by the Court of Justice, or at minimal for a slight adaptation of the condition.

The adoption of an interpretative document does not seem to be an option here, as there is no element in the directive that needs clarification, but the elements subject to the referral to the EU jurisdiction. The most troublesome element is the notion of “dedicated terminals”. However the notion does not raise issue of interpretation and uncertainty, but is blamed for its narrowness. No interpretative document could extend the notion. The usefulness of an interpretative document in the case of article 5(3) n) is also doubtful as the issue is not to curb too restrictive national implementations of an unclear exception but to adapt an exception that has become too narrow in the information society.

**(ii) A possible modification of the exception**

- **Unmodified conditions**

The objective of the exception, i.e. the consultation for research or private study, as well as the list of beneficiaries, do not need to be modified.

- **Types of works**

The exclusion of the benefit of the exception for **works subject to purchase or licensing conditions**, that makes the market prevail over the exception, should neither be changed in our view, should the European Court of Justice interpret it reasonably.

The exclusion of **database** from the exception for on-site consultation through the effect of the *lex specialis* rule of the directive 96/9 does not raise any issue in practice as databases will generally be subject to licensing conditions that would govern the conditions of use, consultation and extraction.

As to **software**, the similar rule of exclusion from the exceptions of the InfoSoc Directive is more problematic for archives and museums specialised in the history of software and video games that contain source code protected under the directive 2009/24. Yet, the making available on some equipment is the only way to make them available for research. Therefore the application of the exception provided for in the article 5(3) n) to such types of works should be clarified.

As a matter of principle, the application of the exception to **unpublished works** should be left to Member States. If excluded from the exempted use, they would still be consultable by researchers on the premises of the library in an analogue format (which does not infringe any rights of reproduction or making available) at the condition they do not exist only in a digital format (for instance because an unpublished work has been created in a digital format). The interest of research could nevertheless point at another solution that would include unpublished works under that exception, upon the requirement that such making available to individual researchers does not amount to a public divulgation of an undisclosed work.

- **Technical and spatial limitations**

The focus of a possible adaptation of the exception will be on the requirements of dedicated terminal and limitation to the premises of the eligible establishment.

The limitation to dedicated terminals can also be explained by security reasons and the need to limit the effect of the exception. The perimeter of use is bordered and controlled by the technical features of the device, as (normally) decided by the library. Generally it will imply that the user will only be able to view the material and not to make any copy of it, except maybe for print-outs. By comparison, allowing the user to get access to the works through her own device makes the work more open to further reproduction and other uses that will go beyond the mere consultation. Here also, the German Federal Court has asked to the CJEU to decide whether some possibility of copying and printing should not be authorized for users to fulfil the needs of research.

More generally, the use being bound to the physical premises of the institutions, the purpose is not to compete with services offered on line by copyright owners.

In summary, the discussion opposes an evolving notion of the needs of consultation for research that refuses to be bound to technical constraints and the need to confine the exception in strict and secured boundaries to prevent interference with the normal exploitation of works. Should the condition of dedicated terminals be abolished to allow more broadly the consultation of library's collection on any device connected to website of the library, there might be a need to secure the consultation if it happens on standard devices, for instance by requiring that the works be viewable only in a format that permits the



acts strictly necessary for research or private study, such as the browsing, searching, possibly printing out, but that disables permanent copying or retransmission on-line or to another device. Such an obligation of technical securisation would be in charge of the libraries and other institutions making the works available

A second question yielded by the deletion of the technical constraint, would be to determine the new perimeter opened by the suppression of this technical restriction that leaves only the spatial limitation to the premises of the institution.

The current approach of the directive is both technical (dedicated terminals) and spatial (on the premises). An approach that would only be spatial and related to the physical premises of the library, museum or archive, would imply in any case that the researcher wishing to view the material made available under the exception be connected to the network of the library. The making available will then have an extended scope, as it would occur at least through the intranet of the institution. In such a case, why should the researcher still come to the library in person, if connecting to the library on-line (even with a secured connection) is sufficient? What can she not consult the collection provided by the library from her office or even when working at home?

Considering that the user does not need to view the work on dedicated devices, but could get access to the work through his own computer, it could result in the access to the premises of the library becoming only virtual. No remote consultation is allowed under the current provision of article 5(3) n) altogether. Yet, deciding about the proper interpretation the “on the premises” condition, severed from the requirement of restricted reading points, will amount to determine the extent of remote consultation. Here are the successive and gradual approaches that could substitute to the technical/spatial one that is currently in force:

- **spatial limitation:** if one decides to suppress the condition of dedicated terminals without extending the exception, the making available could still be bound to the premises of the institution, that would be spatially defined. Therefore, the communication of the work or making available would only be authorised if taking place within the premises of the library, whether on standard equipment available for research or private study or on the equipment of the user requiring such consultation. Such a solution could appear as unnecessarily restraining the possibilities of consultation as the physical restriction has no necessity if the connection happens through a remote connection in any case.
- **institutional limitation:** An institutional approach would extend the consultation beyond the physical location of the eligible establishment, the premises encompassing all the locations of the institutions from which its members entitled to carry out research or private study could access to the library services, for example the researchers of a university in their offices without being obliged to walk to the library site. An even broader approach, but still bound by an institutional definition, would be to allow the entitled members of an institution to access the collection from whatever location but through a closed network. The researcher could then consult the work made available by its university library from home or wherever in the world through a secured log-in. An institutional perspective of the notion of “premises” could also overcome the non-application of the exception to delocalised sections of some institutions. One example is a national library in charge of legal deposit, that would permit the remote consultation of works in its collection by researchers that are present on the premises of its affiliates libraries located in other major cities of the country. On the other hand, one could contend that the institutional approach is only valid for institutions such as universities that have an institutional relationship with their researchers but would be difficult to apply in generalist libraries, museums or archives that are likely to welcome any individual claiming an access for research or private study. The exception is defined by its purpose of allowing consultation for research and private study, which could be potentially exercised by anyone. Opening consultation should then allow any access by an individual doing research or private study. This constitutes a significant obstacle to an institutional approach, broadly defined, as it could potentially allow almost unlimited on-line consultation of libraries' collections. Some limitation could be found in the requirement of registration of the user

at the library (of her region or country of residence), to mimic the conditions for on-site consultation.

- **Functional limitation:** a functional approach, based on the objective of consultation for research or private study would be the last frontier. It would open up the exception to the largest extent, and probably to an excessive extent. It would mean that the eligible institutions could make available works of their collections for research or private study to users demonstrating such purpose (which could be difficult to ascertain for private study<sup>801</sup>). Then, the “on-site” limitation of the exception would disappear. Actually, this would extend the on-site consultation to on-line dissemination of works, with the only limitation (subject to evidentiary difficulties) of the purpose of consultation. That could however prejudice the normal exploitation of works and not be allowed.

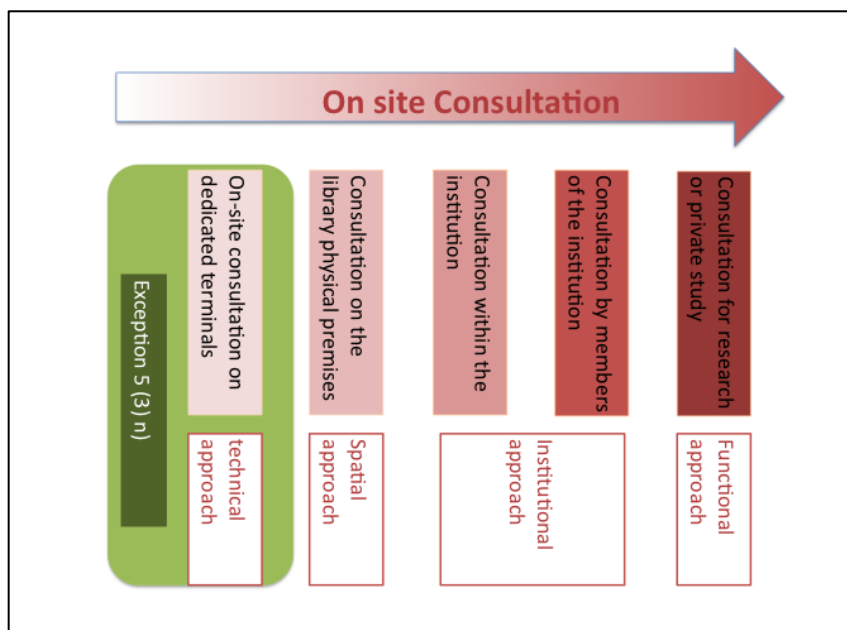

This successive extension demonstrates that any extension of the notion of ‘premises’ beyond a strict physical location (the building or even the rooms occupied by the library), once abolished the requirement of dedicated terminals, would be a slippery slope. Opening the consultation at distance quickly steps over an unlimited act of making available that is generally not encompassed in the exceptions benefiting libraries and other cultural heritage institutions, but covered by licensing agreements with copyright owners. Yet the evolving communication possibilities could equally induce that the notion of on-site consultation be relatively free of tangible and spatial restraints.

<sup>801</sup> See, by comparison, the exception of the UK Copyright Act authorizing libraries to send a copy of some types of works to researchers upon request, on the condition of a written declaration.

Should the exception be extended by adopting a larger notion of “premises”, the following requirements (as discussed in the different approaches) could be considered:

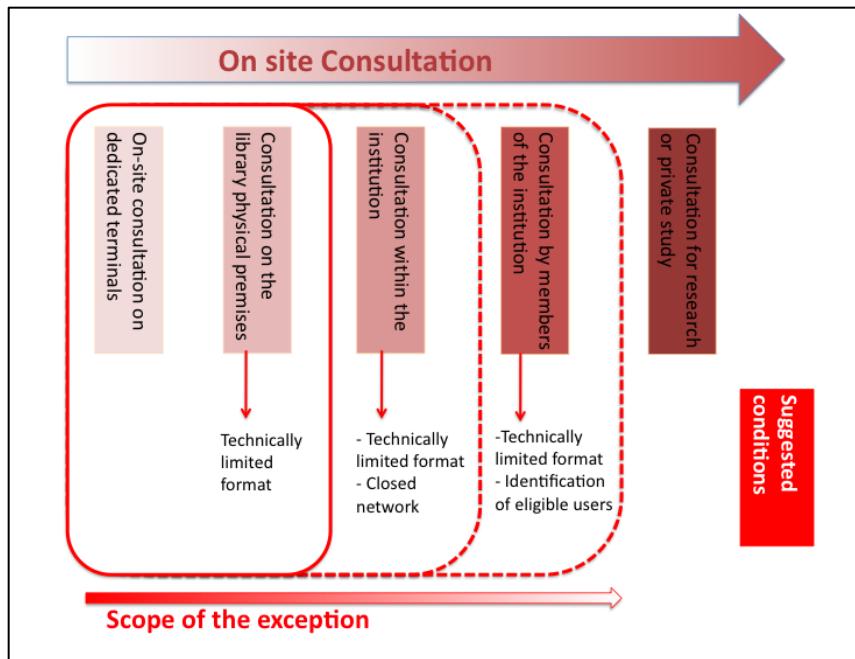

As to the other acts authorized by the exception, copies for private uses in the case of on-site consultation are necessary counterparts to research and private study, but they will normally be dealt with the private copy and reprography exceptions<sup>802</sup>. In addition, the user should also agree that the use of these extracts is strictly dedicated to purposes of study, research or teaching, excluding any commercial end<sup>803</sup>.

<sup>802</sup> F. STASSE, *op. cit.*, p. 15.

<sup>803</sup> *Ibidem*.

## D. Digital public lending

With the outbreak of commercial exploitation of e-books due to the success of the Kindle by Amazon and soon after, of tablets and other e-readers, libraries have embarked on the practice of making e-books available to their patrons in what resembles to the traditional activity of lending. Patrons are increasingly in demand of finding e-books in their libraries. While e-lending has become a reality in some countries, such as the US where thousands of libraries propose to download e-books, experiments have started in many European States. In all those cases, remote loans of e-books are organized by licensing between publishers and libraries, generally with the intercession of an intermediary offering a dedicated platform for e-lending.

Lending is understood in the European Union as pertaining only to books and other works in tangible format. Hence, offsite lending of digital content cannot in principle benefit from the regulatory frame that exists in most Member States and authorizes public libraries to engage in lending against remuneration to authors (from which some establishments can even be exempted).

E-books will certainly become a new cultural product. Generally defined as "an electronic version of a printed book,"<sup>804</sup> an e-book does not necessarily have a printed equivalent. Soon, some specialized books might only be commercialized in an electronic version. But e-books have also escaped the literary form and have been developed as multimedia products for smartphones and tablets. Early examples of such new types of digital creation, particularly children's books, include features that would not fit on paper such as animated images or interactive narration<sup>805</sup>. Audiobooks in digital version can also enter in the category of e-books.

Libraries have started to buy these new cultural objects and would like to include them in the offer of books that can be borrowed by their patrons. The question is whether this new form of lending should follow the regime of traditional lending, that is rather permissive for public libraries, or whether it should remain controlled by the exclusive right of copyright and related rights, which would require libraries to obtain the proper license before making their e-collections available.

This part of the study aims at examining a possible and limited update of the public lending of digital files held in public establishments and whether and under which conditions it would be possible to provide for remote access to such files<sup>806</sup>.

The activity of lending addressed in this report encompasses two different situations:

- the first one covers the **lending of e-books**, either by installing them on devices of the user (tablets, smartphones or computers) or by lending an e-reader on which some content has been loaded by the library;
- the second one could be called the **e-lending** that would stand for the making available of digital works by public libraries for a limited duration through the Internet or libraries' networks, by downloading, streaming or similar modes of transmission<sup>807</sup>.

---

<sup>804</sup> See the definition given by the Oxford Dictionary of English.

<sup>805</sup> See the famous *Alice for iPad* by Atomic Antelope.

<sup>806</sup> We refer to the Annex A (Task Specifications, Study on the application of directive 2001/29/EC on copyright and related rights in the information society (the "Infosoc Directive") of the *Specific Contract: Markt/2012/013/D1/ST/SC implementing Framework Contract No PN/2009-35 D* between the Commission of the European Communities and De Wolf & Partners.

<sup>807</sup> This definition is taken from R. VAN DER NOLL, K. BREEMEN, V. BREEMEN, B. HUGENHOLTZ, M. BROM & J. POORT, *Online uitleen van e-books door bibliotheken. Verkenning juridische mogelijkheden en economische effecten*, in opdracht van het Ministerie van Onderwijs, Cultuur en Wetenschap, Amsterdam, 2012, [www.ivir.nl/publicaties/poort/Online\\_uitleen\\_van\\_e-books.pdf](http://www.ivir.nl/publicaties/poort/Online_uitleen_van_e-books.pdf), p.2.

The e-lending will be the primary focus of this report, while the setting up of digital content on e-readers will only be subsidiarity examined.

Commercial books retailers have also started to develop e-lending services. A typical case is Amazon that offers one e-book each month<sup>808</sup> for a premium yearly subscription of 49\$. Such business models have only the name of e-lending as they have not much to do with public lending right, but could rather be considered as forms of rental. They will not be discussed further.

Like lending, e-lending is generally understood as referring only to literary works, i.e. e-books. Yet, public libraries have carried out activities of lending for other types of content, such as music, films on DVD, audiobooks, videogames. Similarly, experiences of making music recordings available by music libraries have been also tempted, for instance in the Netherlands<sup>809</sup>. Music and films will not be the primary focus of this report but will be addressed only incidentally.

This report will be made of three parts. The first one will present the current context of public lending by libraries, both in practice and in legal perspective (1.). A second part will examine the shift from traditional lending to on-line lending, its consequences and its legal treatment in EU law (2.). Then the report will consider whether the current framework of public lending right should be modified to extend to e-lending and if yes, under what conditions (3.).

## **1. The context of public lending by libraries**

### **a) The different situations of lending in libraries**

Lending of books or other cultural or scientific items is a major activity of libraries, belonging to their mission of making culture available to the public.

However the volume and objective of lending significantly differ from one type of library to the other, with the consequence that the activity presents a varying impact on the practices of users, market of copyrighted works and protection of rights holders.

A first distinction has to be drawn between academic and research libraries on one hand and general public libraries on the other. Academic and research libraries can be defined as institutions that are either associated with universities or research establishments. Their aim is to support scholarly or scientific research. Their main activity is to constitute a collection of scholarly books, journals or databases, that will be mostly consulted on the premises of the library. Acts of lending happen but are more limited than in general libraries. Researchers and students will check out books from those libraries, when they need more time to search in the book what they are looking for. The objective of the lending is thus research and thorough consultation, without necessarily an extensive reading of the book. Academic and research libraries will also engage more often in interlibrary loans.

The National Library that exists in most Member States (e.g. the British Library or the Bibliothèque Nationale de France) and is in charge of the legal deposit and of the preservation of a cultural heritage of a State can be considered as a research library. The lending activity will be minimal compared to on-site consultation for research and the provision of materials to other institutions through the interlibrary loan. Besides, a significant part of their collection, consisting of documents, maps, manuscripts, newspapers, magazines, prints and drawings, music scores, photographs, or old publications, is not subject to lending, due to their historical importance, state of decay or uniqueness. Research libraries or national libraries

---

<sup>808</sup> In the Amazon model, the 'lending' is not bound by a limited duration but one borrowed book can only be replaced by a new one when returned.

<sup>809</sup> See Digileen in the Netherlands by the Centrale Discotheek Rotterdam (through a licensing contract with small music labels and the music CMO BumaStemra)

are sometimes referred to as 'reference libraries' as a more or less large part of their collections can only be viewed on site in reading rooms.

General public libraries have a different mission. They aim at providing the public, with no discrimination, with materials for private study and entertainment. Their main activity is lending and the consultation of their books or other items on the premises of the establishment is rather limited (except for reference books or magazines). They can have a specialised section (e.g. for children books) and organise specific activities for some types of public. The patrons of those libraries check out books mainly for private enjoyment and study.

In addition to these two major categories, libraries can also serve special needs of a limited part of the public. For instance, social institutions such as hospitals, prisons or schools might have a library that provides books or other works to the patients, inmates or students. They will be reserved to a limited public. The main activity of such libraries will be to lend books to their specific users.

Some libraries can also provide specialised documentation to professionals and know restricted conditions of admission. For instance, some libraries are operated by governments to the benefit of their civil servants, but can equally be open to individuals upon defined conditions. For example the libraries of judicial courts generally admit professional lawyers who are registered at the bar. Usually those types of libraries will not lend books beyond the members of the institution they serve. Other specialised libraries will not be open to the public, such as libraries of private companies or governmental libraries with restricted admission policies.

Within the public libraries, some distinction could also be drawn depending of the type of cultural items subject to lending. Libraries generally refer to books in the general opinion, but public institutions deal with other types of content as well, such as phonograms, DVDs, videogames or audiobooks. Public libraries can either have collections of different categories of works. Or content other than books might be hold and made available by dedicated multimedia libraries or *médiathèques*. Lending also occurs in those institutions, under somewhat adapted conditions.

The public targeted by libraries will depend on their category. Whereas general public libraries by definition address the needs of the general population to get access to cultural content, academic and research libraries are primarily visited by the members of their institutions (students, professors, researchers for academic libraries) and researchers in a broader sense. They are nevertheless open to the public and used to cater to the needs of professionals looking for specialised information (such as private lawyers visiting law libraries). Specialised libraries in social institutions will have a more limited audience. Public libraries also play an important role for people with reading disabilities. Dedicated libraries exist in many countries to provide books in Braille, audiobooks or other adapted forms to visually-impaired people, but general libraries also try to have a collection of large print books and audiobooks.

In summary, the following comparison can be made :

	<b><i>Academic/Research library</i></b>	<b><i>Generalist Public library</i></b>	<b><i>Specialised library</i></b>
<i>Collections</i>	Scholarly or research books	All types of books  Sometimes other types of works	Limited collection
<i>Part of lending in the library activity</i>	Limited number of loans  Not a major part of the activity	Important number of loans  Major part of activity	Limited number of loans  Major part of activity (except for professional libraries)

<i>Public</i>	Researchers, professors, students + interested public	General public, including young people, socially disfavoured people and older persons	Public of the social institutions or members, employees and admitted professionals
<i>Objective of the lending</i>	Research and consultation	Reading, private study and enjoyment	Reading, private study and enjoyment
<i>Duration of lending</i>	Longer and renewable duration	Limited duration (normally renewable)	Limited duration
<i>Other elements</i>	Regular recourse to interlibrary loans	Organisation of other activities	

## b) The legal context of lending

### (i) *The scope of public lending right in the European Union law*

Rental and lending rights have been introduced as exclusive rights in the European copyright by a directive of 1992, that has since been codified in the directive 2006/115 of December 12<sup>th</sup>, 2006. Article 1 of the directive<sup>810</sup> states that “in accordance with the provisions of this Chapter, Member States shall provide, subject to Article 6, a right to authorize or prohibit the rental and lending of originals and copies of copyright works, and other subject matter as set out in Article 3(1)”. The notion of lending contained in the directive only refers to acts of *public lending* since, according to its article 2 (1) b), “lending’ means making available for use, for a limited period of time and not for direct or indirect economic or commercial advantage, when it is made through establishments which are accessible to the public”. The terminology of public lending right is however generally used to refer to the right of remuneration that the article 6 of the directive allows Member States to enact instead of the exclusive lending right stated as a principle. Certain categories of establishments can even be exempted from the payment of the remuneration.

Lending is covered by the directive when:

- a work is **made available for use**: Recital 10 excludes from the lending (and the rental) right certain acts of making available such as for example “making available phonograms or films for the purpose of public performance or broadcasting, making available for the purpose of exhibition, or making available for on-the-spot reference use”<sup>811</sup>. In addition lending “should not include making available between establishments which are accessible to the public”<sup>812</sup>, which refers to interlibrary loans. Such transfers of works between libraries avoid then the application of the exclusive right. Interlibrary loans (in a tangible format) are not subject to the authorisation of copyright owners, not because of an exception, but simply as they are not covered by the exclusive right of lending. The directive further allows for similar cases where there would be no use within the meaning of lending, that would therefore not be covered by the directive<sup>813</sup>.
- for a **limited period of time**, which is a common element to rental and lending;

<sup>810</sup> Directive 2006/115/EC of the European Parliament and of the Council of 12 December 2006 on rental and lending right and on certain rights Related to copyright in the field of intellectual property (codified version), OJ, L 376 of 27 December 2006, p. 8.

<sup>811</sup> Recital 10.

<sup>812</sup> Recital 10.

<sup>813</sup> M. WALTER & S. VON LEWINSKI, *op. cit.*, n° 6.1.12.

- **not for direct or indirect economic or commercial advantage** : this criterion distinguishes lending from rental and is further defined by the recital 11 of the directive that provides that “Where lending by an establishment accessible to the public gives rise to a payment the amount of which does not go beyond what is necessary to cover the operating costs of the establishment, there is no direct or indirect economic or commercial advantage within the meaning of this Directive”. Therefore, the payment of a fee for lending does not exclude the qualification of lending<sup>814</sup>. Contrary to the exception of the InfoSoc Directive for certain acts of reproduction by libraries, archives and museums, analysed *supra*, this condition applies to the act of lending and not to the beneficiary;
- by establishments which are **accessible to the public** : this notion is not defined in the directive<sup>815</sup>. The initial proposal for a directive included a list of the eligible establishments encompassing “public libraries, research libraries, specialized libraries, school libraries, church libraries, collections of new media or of works of visual art, libraries organized or sponsored by public or private companies, and other collections of subject matter”<sup>816</sup>. The condition of public accessibility should be broadly construed and includes libraries open to a specified public.

The exclusive lending right shall belong to the author, the performer, the phonogram producer and the producer of the first fixation of a film (Article 3(1)). Buildings and works of applied art are not covered with the directive<sup>817</sup>.

Article 6<sup>818</sup> allows Member States to replace the exclusive right by a remuneration right and even to exempt certain categories of establishments from this remuneration. This could include “traditional public libraries, but also libraries of universities and educational establishments”<sup>819</sup>. The exception for public lending right “reflects the compromise found at the time between complying with the Internal Market needs on the one hand and taking account of the different traditions of Member States in this area on the other”<sup>820</sup>.

The objective of such derogation is clearly the promotion of cultural objectives, which is referred to in article 6(1) as justifying the leeway left to the States in determining the remuneration. Some establishments could be exempted from any remuneration, at the exception of lending of phonograms, films or computer programs (if those categories of works are encompassed in the lending right). The law could also dispense some institutions, e.g. university and school libraries, libraries in social institutions or

<sup>814</sup> J. KRIKKE, “Council Directive 92/100/EEC (Rental and Lending Right Directive) of 19 November 1992 on rental right and lending right and on certain rights related to copyright in the field of intellectual property”, in Th. Dreier and B. Hugenholtz (ed.), *Concise European Copyright Law*, Alphen aan den Rijn, Kluwer Law International, 2006, p. 239, esp. p. 244.

<sup>815</sup> V.-L. BENABOU, *Droits d’auteur, droits voisins et droit communautaire*, Bruxelles, Bruylant, 1997, n° 501 who explains that this condition excludes from the scope of the directive private lending which is not subject to the exclusive rights of the authors.

<sup>816</sup> Article 1(4) of the Proposal for a Council Directive on rental right, lending right, and on certain rights related to copyright, COM(1990) 586final. See M WALTER & S. VON LEWINSKI, *op. cit.*, n° 6.1.30.

<sup>817</sup> Art. 3, 2.

<sup>818</sup> Article 6 « Derogation from the exclusive public lending right

1. Member States may derogate from the exclusive right provided for in Article 1 in respect of public lending, provided that at least authors obtain a remuneration for such lending. Member States shall be free to determine this remuneration taking account of their cultural promotion objectives.

2. Where Member States do not apply the exclusive lending right provided for in Article 1 as regards phonograms, films and computer programs, they shall introduce, at least for authors, a remuneration.

3. Member States may exempt certain categories of establishments from the payment of the remuneration referred to in paragraphs 1 and 2 ». See the developments of M WALTER & S. VON LEWINSKI, *op. cit.*, n° 6.5.8 and followings.

<sup>819</sup> **Report from the Commission of 12 September 2002 to the Council, the European Parliament and the Economic and Social Committee on the public lending right in the European Union, op. cit., n° 3.3. See also the history of this compromise as related by M WALTER & S. VON LEWINSKI, op. cit., n° 6.5.1.-6.5.6.**

<sup>820</sup> **Report from the Commission of 12 September 2002 to the Council, the European Parliament and the Economic and Social Committee on the public lending right in the European Union, op. cit., n° 3.3.**



some public libraries, from any remuneration obligation. The European Court of Justice has nevertheless decided that Member States are not entitled to exempt all public libraries from the payment of the remuneration, as such a large-scale exemption would result in emptying the public lending right of any relevance<sup>821</sup>.

More recently, the European judges have decided that the remuneration to authors for public lending cannot be calculated solely on the basis on the number of borrowers of works, but that the amount of the remuneration should also take into account the works available to the public, so that the biggest public lending establishments pay more than the smaller institutions<sup>822</sup>.

The legal form of the derogation is left to the Member States<sup>823</sup>. The exemption of the exclusive right is often understood as creating an exception in the form of a statutory license, with a right to remuneration<sup>824</sup>. In other countries, the public lending right is just recognised as a remuneration right for the copyright and related rights owners. For the present study, we will opt for the terminology of statutory or legal license to designate the exception created by the public lending right in favour of libraries.

### **(ii) The national implementations of the public lending right in Member States**

Without describing in details the different transpositions of the lending right in the Member States, that is not necessary for this study, the situation in the Member States we have analysed will be rapidly sketched.

Most Member States have seized the possibility to transform the public lending into a remuneration right, instead than an exclusive right, as well as the possibility to exempt some establishments from any remuneration<sup>825</sup>.

As to the **beneficiaries of public lending**, Belgium<sup>826</sup> limits the exception to institutions that are approved or officially established by the public authorities for the educational and cultural purpose. Likewise, only libraries and record libraries belonging to the State or to public authorities and making loans exclusively for purposes of cultural promotion and personal study enjoy the exception under Italian law.<sup>827</sup> Likewise, the UK<sup>828</sup> provides for the exception for the benefit of local library authorities. Germany<sup>829</sup> grants the exception to publicly accessible institutions (library, collection of video or audio recordings or other originals or copies thereof) and Denmark<sup>830</sup> to public libraries (as in France<sup>831</sup>, Italy<sup>832</sup> and Hungary)<sup>833</sup>, the elementary school libraries and the Danish National Library for the Blind.

<sup>821</sup> E.C.J., judgment of 26 October 2006, C-198/05, *Commission / Italy*, ECR, 2006, I-107; E.C.J., judgment of 26 October 2006, C-36/05, *Commission / Spain*, ECR, 2006, I-10313; E.C.J., judgment of 6 July 2006, C-53/05, *Commission / Portugal*, ECR, 2006, I-06215.

<sup>822</sup> C.J.E.U., 30 June 2011, *VEWA*, C-271/10, ECR, 2011, I-5815.

<sup>823</sup> M WALTER & S. VON LEWINSKI, *op. cit.*, n°6.1.16.

<sup>824</sup> Ch. ALLEAUME, "Le droit de prêt public (en France et au-delà)", *Propri. intell.*, 2004, n° 12, p. 726.

<sup>825</sup> See The Report from the Commission to the Council, the European Parliament and the Economic and Social Committee on the Public Lending Right in the European Union, 12 September 2002, COM(2002) 502 final.

<sup>826</sup> Article 5 of the Royal Decree of 25 April 2004 related to the right to remuneration for public lending of the authors, the performers, the producers of phonograms and the producers of first fixations of films.

<sup>827</sup> Article 69 of the Italian Law No. 633 of 22 April 1941 for the Protection of the Copyright and the Other Related Rights to its Exercise.

<sup>828</sup> Article 1 of the British Public Lending Right Act of 1979.

<sup>829</sup> Article 27 of the German Act of 9 September 1965 on Copyright and Related Rights.

<sup>830</sup> Article 5 of the Danish Consolidated Public Lending Right Remuneration Act No. 1175 of 17 December 2002.

<sup>831</sup> Article L.133-1 (library open to the public) of the French Intellectual Property Code of 1 July 1992. The eligible libraries are further defined by the article R. 133-1 as libraries of territorial collectivities, scientific, cultural or professional public establishments and

Libraries, archives and schools benefit from the exception in Poland<sup>834</sup>. If libraries and archives as museums are in public ownership or belong to institutions of general cultural, scientific or educational interest without gainful intent, they also benefit from the exception in Spain<sup>835</sup>.

As far as the **type of works** subject to public lending is concerned, the UK<sup>836</sup> specifically reserves the exception to books. Similarly France restricts the public lending to a work “subject to a publishing contract for its publication and distribution in a book format”<sup>837</sup>.

Belgium<sup>838</sup> limits the works concerned to literary works, databases, photographic works, scores of musical works, sound and audiovisual works while Hungary<sup>839</sup> only applies the exception to literary works and printed music sheets. The Italian provision includes literary and print works (with the exception of music scores and sheets), phonograms and video recordings embodying cinematographic or audiovisual works.<sup>840</sup>

As required by the directive, **remuneration** is granted to authors in Belgium<sup>841</sup>, Luxemburg<sup>842</sup>, Denmark<sup>843</sup>, France<sup>844</sup>, Germany<sup>845</sup>, Hungary<sup>846</sup>, the Netherlands<sup>847</sup> and the UK<sup>848</sup>. Depending on the countries, it is fully supported by the public authorities organising libraries or partially by the libraries’ users. Poland seems to be still discussing the modalities of the perception and amount of

other educational establishments, of enterprises’ committees as well as any library or establishment making a documentary collection available to the public.

<sup>832</sup> Article 69, (1) (establishments which are accessible to the public) of the Italian Law No. 633 of 22 April 1941 for the Protection of the Copyright and the Other Related Rights to its Exercise.

<sup>833</sup> Article 23/A (libraries conducting public lending activity) of the Hungarian Act LXXVI of 22 June 1999 on Copyright.

<sup>834</sup> Article 28 of the Polish Law No. 83 of 4 February 1994 on Copyright and Neighboring Rights.

<sup>835</sup> Article 37 of the Spanish Consolidated Text of 1 April 1996 on Intellectual Property.

<sup>836</sup> Article 1 of the British Public Lending Right Act of 1979, [www.legislation.gov.uk/ukpga/1979/10/contents](http://www.legislation.gov.uk/ukpga/1979/10/contents). REPROBEL, *Public lending right*, 9<sup>th</sup> International PLR Conference, 22-24 September 2011, Brussels, [www.reprobel.be/fr/reprobel-en-quelques-mots/reprobel/licences-legales/leenrecht/conference-internationale-sur-le-pret-public.html](http://www.reprobel.be/fr/reprobel-en-quelques-mots/reprobel/licences-legales/leenrecht/conference-internationale-sur-le-pret-public.html), p. 115: “[T]he PLR scheme remains restricted to loans from public libraries of printed books. Before the general election last year the government was successful in passing the Digital economy act which will enable PLR to be extended to cover ‘loans’ of certain types of e-books and audio books by public libraries. However, following the election the new government decided to postpone this extension of the PLR scheme at a time when they were trying to reduce public expenditure”.

<sup>837</sup> Article L133-1 of the French Intellectual Property Code of 1 July 1992. The exception has been implemented in 2003.

<sup>838</sup> Article 23 of the Belgian Law of 30 June 1994 related to Copyright and Neighboring Rights.

<sup>839</sup> Article 23/A of the Hungarian Act LXXVI of 22 June 1999 on Copyright.

<sup>840</sup> Article 69 of the Italian Law No. 633 of 22 April 1941 for the Protection of the Copyright and the Other Related Rights to its Exercise, , provides that public libraries and public record libraries (i.e., belonging to the State or to other public bodies) are allowed to make loans without the right-holder authorization for sole purposes of cultural promotion and personal study.

<sup>841</sup> Article 62 of the Belgian Law of 30 June 1994 related to Copyright and Neighboring Rights.

<sup>842</sup> Article 65 of the Luxemburg Law of 18 April 2001 on Copyrights, Neighbouring Rights and Databases.

<sup>843</sup> Article 1 of the Danish Consolidated Public Lending Right Remuneration Act No. 1175 of 17 December 2002.

<sup>844</sup> Article L133-1 and L133-4 of the French Intellectual Property Code of 1 July 1992.

<sup>845</sup> Article 27 of the German Act of 9 September 1965 on Copyright and Related Rights.

<sup>846</sup> Article 23/A of the Hungarian Act LXXVI of 22 June 1999 on Copyright.

<sup>847</sup> For the Netherlands, see the recent decision of the Hoge Raad, 23 October 2012, *Vereniging Openbare Bibliotheken v. Stichting Recht, NJ*, 2013, nr 381.

<sup>848</sup> Article 1 of the British Public Lending Right Act of 1979. REPROBEL, *op. cit.*, p. 115: “PLR is open to any author regardless of nationality so long as they live in a European Economic Area country.” See article 47 of the Public Lending Right Scheme 1982, [www.legislation.gov.uk/uksi/1982/719/contents/made](http://www.legislation.gov.uk/uksi/1982/719/contents/made): The person entitled to the Public Lending Right in respect of any registered book in any financial year shall be the registered owner thereof as at 30th June of that year.

remuneration<sup>849</sup>, as well as Spain<sup>850</sup> where a draft for a Royal Decree to regulate the compensation for public lending<sup>851</sup> has recently been introduced.

In particular, publishers are added to authors and related rights holders as beneficiaries of the right of remuneration in Belgium<sup>852</sup> and France<sup>853</sup>.

Several Member States provide for an **exemption from the payment of the remuneration**. This exemption concerns teaching and research establishments in Belgium<sup>854</sup>, Luxemburg<sup>855</sup>, the Netherlands<sup>856</sup>, libraries of teaching institutions in Spain<sup>857</sup>.

In addition Belgium<sup>858</sup> provides for the exemption for healthcare institutions and institutions created for the blind, visually-impaired, deaf and hearing-impaired. The Netherlands also excludes libraries acting for visually-impaired people as well as the Koninklijke Bibliotheek (the National Library of the Netherlands)<sup>859</sup>.

Luxemburg<sup>860</sup> broadly exempts from payment of the remuneration institutions and establishments carrying out specialized lending, thematic lending or lending to a targeted public.

An **embargo period or release window**, i.e. a minimum period of time after the first commercialisation of the work, is applied to lending in the UK<sup>861</sup>, Belgium and Italy. Belgium requires that sound or audiovisual works may not be loaned earlier than fourth months<sup>862</sup> and Italy<sup>863</sup> at least eighteen months since the first putting in the market of that work or, in the case the right of distribution has not been exercised, at least twenty four months since the realization of phonograms and videograms containing cinematographic or audiovisual works or sequences of moving images, with or without sound.

---

<sup>849</sup> Article 28 of the Polish Law No. 83 of 4 February 1994 on Copyright and Neighbouring Rights. REPROBEL, *op. cit.*, p. 87: "The PLR system is not established yet. Art 28 of the Copyright act provides that libraries, archives and schools shall be allowed to lend books and other materials without any remuneration for authors and publishers. During 2011 representatives of the ministry of Culture and national Heritage have declared many times that work on a PLR system in Poland will start in 2012. *Polska Książka*, the society of authors and publishers (which is an RRO) and the polish Book Chamber are lobbying for full implementation of a PLR system in Poland". <sup>849</sup>

<sup>850</sup> Article 37 of the Spanish Consolidated Text of 1 April 1996 on Intellectual Property.

<sup>851</sup> Real Decreto por el que se regula la remuneración a los autores por los préstamos de sus obras realizados en determinados establecimientos accesibles al public, versión 2.5, 8-2-2013.

<sup>852</sup> Article 62 of the Belgian Law of 30 June 1994 related to Copyright and Neighbouring Rights.

<sup>853</sup> Article L133-4 of the French Intellectual Property Code of 1 July 1992.

<sup>854</sup> Article 5 of the Royal Decree of 25 April 2004 related to the right to remuneration for public lending of the authors, the performers, the producers of phonograms and the producers of first fixations of films. All the establishments or institutions concerned in Belgium are recognized or officially organized for their purpose by the public authorities.

<sup>855</sup> Article 65 of the Luxemburg Law of 18 April 2001 on Copyrights, Neighbouring Rights and Databases.

<sup>856</sup> Article 15c of the Dutch Law containing New Regulation of Copyright of 23 September 1912.

<sup>857</sup> Article 37 of the Spanish Consolidated Text of 1 April 1996 on Intellectual Property, provided that the teaching institutions are integrated in the Spanish educational system.

<sup>858</sup> Article 5 of the Royal Decree of 25 April 2004 related to the right to remuneration for public lending of the authors, the performers, the producers of phonograms and the producers of first fixations of films.

<sup>859</sup> Article 15c of the Dutch Law containing New Regulation of Copyright of 23 September 1912.

<sup>860</sup> Article 65 of the Luxemburg Law of 18 April 2001 on Copyrights, Neighbouring Rights and Databases.

<sup>861</sup> Article 1 of the British Public Lending Right Act of 1979.

<sup>862</sup> Article 23 of the Belgian Law of 30 June 1994 related to Copyright and Neighbouring Rights, in combination with article 3 of the Royal Decree of 25 April 2004 related to the right to remuneration for public lending of the authors, the performers, the producers of phonograms and the producers of first fixations of films.

<sup>863</sup> Article 69 of the Italian Law No. 633 of 22 April 1941 for the Protection of the Copyright and the Other Related Rights to its Exercise.

## 2. From lending to e-lending

### a) Development of e-lending through licensing

In many countries libraries have started to make e-books available online to their members<sup>864</sup>. Lacking any legal authorization to undertake e-lending, this development was made possible by licensing agreements with publishers and the intervention of dedicated platforms hosting and delivering e-books to libraries' users.

Distribution models may vary, but the most common way of proceeding for a library is to have recourse to "an intermediary distributor (sometimes referred to as an "aggregator"), which sells access to e-books titles and copies of e-books, often from multiple publishers"<sup>865</sup>. The distributor offers full-service packages to libraries, with the licensing rights to e-books and the hosting of the e-book collection<sup>866</sup>. Libraries can serve as an interface, through their websites, for their readers to get access to the collection of titles that are available for downloading. The e-book will eventually be sent by the platform operated by the distributor to the user that has requested it.

Some publishers do sell e-books to libraries and allow them to provide them directly to their members, but the proportion of sales is rather small compared to licensing and remote access for libraries<sup>867</sup>.

The primary model governing e-lending can be described as follows<sup>868</sup>:

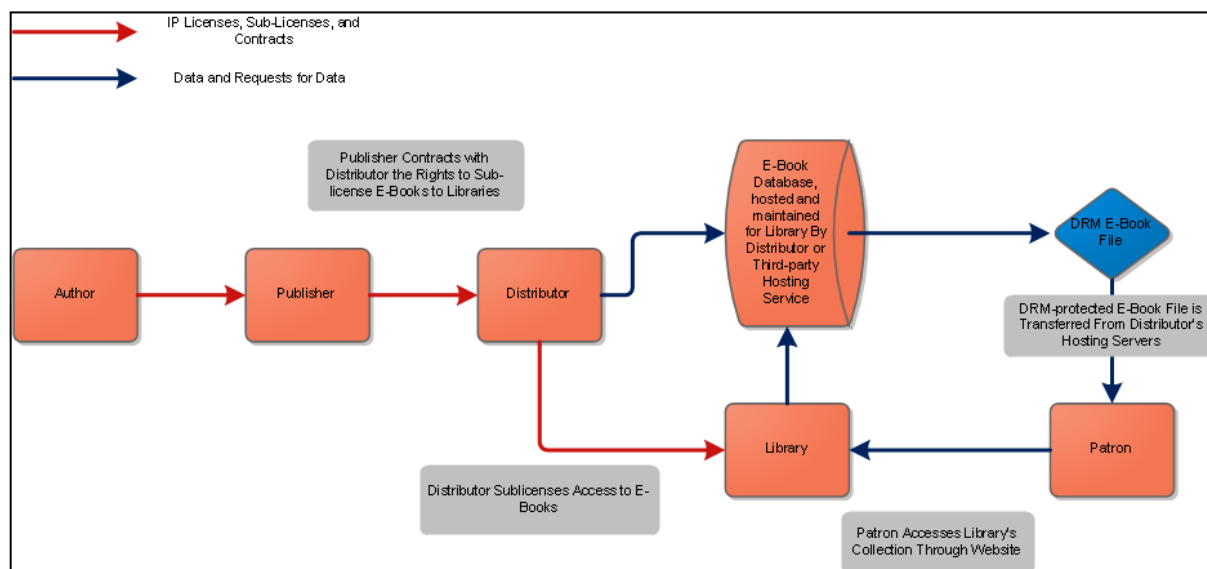

<sup>864</sup> See the following studies or a comprehensive overview of the e-lending situation in Europe and beyond: IDATE CONSULTING, *Etude sur l'offre commerciale de livres numériques à destination des bibliothèques de lecture publique*, Study elaborated for the French Ministry of Culture and Communication, Final Report, 2013, [www.culturecommunication.gouv.fr/Disciplines-et-secteurs/Livre-et-lecture/Actualites/Etude-IDATE-sur-les-livres-numeriques-en-bibliotheque](http://www.culturecommunication.gouv.fr/Disciplines-et-secteurs/Livre-et-lecture/Actualites/Etude-IDATE-sur-les-livres-numeriques-en-bibliotheque), 79 p.; R. VAN DER NOLL ET AL. *Online uitleen van e-books door bibliotheken*, *op. cit.*; D. O'BRIEN, U. GASSER and J. G. PALFREY JR., *E-books in Libraries : A Briefing Document Developed in Preparation for a Workshop on E-lending in Libraries*, Berkman Center Research Publication, n° 2012-15, 2012, <http://ssrn.com/abstract=2111396>, 29 p.

<sup>865</sup> D. O'BRIEN, U. GASSER & J. G. PALFREY JR., *op. cit.*, p. 8.

<sup>866</sup> *Ibidem*, p. 10.

<sup>867</sup> *Ibidem*, p. 8.

<sup>868</sup> This figure is taken from D. O'BRIEN, U. GASSER & J. G. PALFREY JR., *op. cit.*, p. 12.

Source: D. O'BRIEN, U. GASSER and J. G. PALFREY JR., *E-books in Libraries : A Briefing Document Developed in Preparation for a Workshop on E-lending in Libraries*, Berkman Center Research Publication, n° 2012-15, p. 12.

This model includes four actors: the publisher or copyright owner, the distribution platform, the public library and the reader that is the end-user of the loan.

The publishers license the rights for distribution with e-book distributors, a new type of actor on the book market that has emerged to provide services of e-lending to libraries. They sublicense the rights to e-books to libraries for making them available on-line to their patrons, along with additional services such as the operation of a web platform that hosts the e-books, provides a searchable interface for users, manages the availability to readers and the accounts of its libraries clients, and controls the conditions and duration of the loan. This requires the use of Digital Right Management tools embedded in the e-books that are made available, and generally developed and operated by the e-book aggregator.

Platforms for lending are for instance "OverDrive" that dominates the English library market<sup>869</sup>, NetLibrary, Ebscohost in the Netherlands<sup>870</sup>, Dilicom in France or Onleihe.net in Germany.

The **relationship between the publishers and the distributors** triggers the availability of the book on the platform. Publishers decide the format and conditions under which the book will be offered for lending in a way that tends to align the modalities of accessing to e-books to the restraints usually endured by library readers. We will address the differences and similarities of such restraints below.

The **relationship between the libraries and the distributors** is governed by a license that stipulates the conditions of access to e-content by the library and the terms of use. Due to the intercession of an intermediary, the public libraries do not host e-books as they do with tangible books, for they are kept by the intermediary on its platform. The provision of a collection of downloadable titles can be organised in different models. The most common is the so-called 'perpetual access' model<sup>871</sup>, by which libraries acquire an individual copy of an e-book title that will be integrated in the e-collection of the library (in contracts with the subscription model where the access to the title terminates if the subscription is not renewed). In most cases, only one reader at a time can borrow the e-book (one copy/one user model)<sup>872</sup>. It is a kind of "digital replication of the use pattern for a print-on paper library book"<sup>873</sup>.

Several licenses can be bought for popular works to be entitled to lend them to more users simultaneously. The number of licenses then resembles the number of acquisitions of tangible books and its corresponding number of simultaneous readers. Other possibilities are the subscription model with unlimited number of loans per title and limited simultaneous users, or the pay-per-view model.

Books can be bought by individual titles or per packages by the library. Further conditions are laid down by the license and relate to the devices on which the e-book can be downloaded and read, the possibilities to print out and to what extent. Some licenses impose the renewal of the license after some delay or a certain number of loans (e.g. license valid for one year or for 30 circulations), so as to mimic the way tangible books wear out after a few readings and oblige libraries to buy a new copy. The e-books could be proposed in different formats but usually in ePUB that is a format dedicated to e-readers, or in pdf that is readable on more devices.

---

<sup>869</sup> IFLA, *Les fondements du prêt de livres électroniques (E-books)*, 2012, [www.ifla.org/news/ifla-releases-background-paper-on-e-lending](http://www.ifla.org/news/ifla-releases-background-paper-on-e-lending), p. 7.

<sup>870</sup> R. VAN DER NOLL ET AL. *Online uitlenen van e-books door bibliotheken*, op. cit., p. 5.

<sup>871</sup> As explained by IFLA, *Les fondements du prêt de livres électroniques (E-books)*, op. cit., p. 7: « in effect, the typical "in perpetuity" purchase of an eBook through a distributor such as OverDrive using this model only will provide access on an ongoing basis as long as the library maintains a relationship with the distributor or, indeed, as long as the distributor continues to operate ».

<sup>872</sup> R. VAN DER NOLL ET AL. *Online uitlenen van e-books door bibliotheken*, op. cit., p. 6.

<sup>873</sup> P. WHITNEY, *EBooks and Public Lending Right in Canada*, submitted to the *Public Lending Right Commission*, 2011, [www.canadacouncil.ca/en/council/research/find-research/2011/ebooks-and-public-lending-right](http://www.canadacouncil.ca/en/council/research/find-research/2011/ebooks-and-public-lending-right), p. 12.

A remuneration is due by the library for the services performed by the e-book distributor and its platform, that is added to the remuneration agreed upon for the loans themselves.

The **relationship between the library and the user** follows the model put in place. The lending will generally be restricted to the users registered in a library. They will get access to the collection of available titles through the website of their library and can install the e-books on their computers or other devices (such as smartphones, tablets or e-readers). Only a maximum number of books for a determined period could be downloaded and the book will be unavailable at the end of lending term that is generally rather short (2 or 3 weeks). The duration is renewable if the book has not been reserved by another user. Once the book is installed on the device, it can be read offline. Usually, the readers have only access to the e-collection of their library, i.e. to the collection of titles for which the library bought a license. This is the model of the German Onleihe platform where patrons registered in one library have only access to the part of the platform hosting titles for which their library have a license. Other models include consortiums of local libraries (e.g. LibrariesWest in the UK) that have acquired a bulk license for e-books they all propose to their registered patrons.

Users may also be required to assent to contractual terms which impose additional limitations and restrictions on access and use of software or e-books<sup>874</sup>.

## b) Differences between lending and e-lending

E-lending presents some key differences from lending of tangible items that make a simple transposition of rules of public lending right to e-lending rather intricate.

Traditional lending does not require any intervention from the right holder or intermediary. Libraries buy books from publishers, bookstores or specialised intermediaries and become full owners of those books. In some legal systems such as the United States, the authorisation of public lending flows from the application of the first sale doctrine or exhaustion principle: once the book is bought by the library, its further distribution, including lending to library patrons is not an infringement of copyright. On the contrary, the European Union law interposes an exclusive right of lending, generally transformed at State level into a right of remuneration that annuls the exhaustion rule. The act of distribution is legally qualified as an act of lending that is not exhausted but re-enters into the field of control of copyright owners (either by an exclusive right or a right to remuneration). This is clearly stated by the recitals 28 and 29 of the InfoSoc Directive that preclude the application of the distribution qualification and of the rule of exhaustion to rental and lending<sup>875</sup>.

Whatsoever, even if the act of lending has to be authorised or compensated, the ownership of the copy by the library gives it some autonomy in the lending activities.

The overall picture of e-lending is radically different. E-books<sup>876</sup> are acquired under licensing conditions and digitally transmitted to libraries<sup>877</sup>. They are usually not 'bought' and no transfer of ownership occurs at the benefit of the libraries. That explains that in the United States, e-lending could not be developed on the ground of the first sale doctrine<sup>878</sup> but that exclusive rights of copyright regained their primacy.

---

<sup>874</sup> D. O'BRIEN, U. GASSER & J. G. PALFREY JR., *op. cit.*, p. 13.

<sup>875</sup> See recital 28 *in fine* (The distribution right provided for in this Directive is without prejudice to the provisions relating to the rental and lending rights contained in Chapter I of that Directive) and 29 (The question of exhaustion does not arise in the case of services and on-line services in particular. (...) Therefore, the same applies to rental and lending of the original and copies of works or other subject-matter which are services by nature).

<sup>876</sup> It is different for music and films that can be bought in tangible digital items.

<sup>877</sup> D. O'BRIEN, U. GASSER and J. G. PALFREY JR., *op. cit.*, p. 10.

<sup>878</sup> It seems improbable in the wake of the ReDigi decision of a District Court of New York (*Capital Records v. ReDigi Inc.*, S.D.N.Y., 30 March 2013, No. 12 Civ. 95) that the first sale doctrine be applied to digital products downloaded on the internet.

E-books are acquired by libraries from publishers or intermediaries that have emerged to play the role of 'e-books aggregators'. Models of purchase differ greatly depending of the type of the digital product, from electronic journals, scientific publications or textbooks to more mainstream e-books. Vendors propose either an outright purchase, that will result in the downloading of the e-book by the library, or a subscription model where e-books are stored on the intermediary's platform and can be downloaded by the user when the book is checked out. In all cases, a license agreement is entered into and defines the applicable terms of use, that are usually embedded in the digital file by digital rights management (DRM) features. In most cases, the library does not actually 'buy' books but acquires access to a platform and a number of book titles from various publishers.

Such recourse to a platform is useful for all the parties involved. Publishers, specially the smaller ones, are saved the cost of developing and operating a dedicated platform and technological tools (such as the DRM needed to secure the terms of use). Likewise, libraries do not have to develop a platform to make e-books available to their users. The users of the library can then access and search the titles covered by the license through a single interface, whatever the library they are subscribed to, and get access to e-book in a format compatible with their e-reader (generally in ePUB format, less often in pdf).

This change of model has namely the following consequences:

- the book remains in control of the intermediary or platform and largely escapes from library choices or control;
- the book is not bought but is subject to a license;
- the terms of use are enforced by digital rights management systems embedded by publishers and intermediaries and not anymore by the rules and governance of the libraries<sup>879</sup>;
- not all published books are available for lending, but only the titles available as e-books (that will certainly increase in the future to cover the whole catalogue of publishers), formatted to a non-proprietary format<sup>880</sup> and compatible with the platform<sup>881</sup> (which in theory could limit the offer compared to the offer of traditional lending);
- the digital format of an e-book permits multiple downloads and readers whereas a paper book can only be given to one reader at a time.

These differences rooted in the technical features of the digital format and digital transmission, are both a source of concern for publishers that fear that e-lending will potentially undermine their emerging business models related to e-books, and a new landscape where the legal rules and the traditional roles of libraries and publishers do not fit in the same way than for public lending.

### c) e-lending in EU law

The directive on rental and lending does not explicitly excludes e-lending or lending of digital items from its scope. However some elements point in that direction. The article 1 that provides the exclusive right of lending applies it to "the original and copies of copyright works, and other subject matter". This formulation is usually interpreted as encompassing the "first materialisation" of the work and further

---

<sup>879</sup> The extent of the negotiation capacity of libraries is difficult to assess, it could increase with time, as libraries will be more accustomed to e-lending practice.

<sup>880</sup> ePUB and pdf are non-proprietary formats that are accepted on most e-readers. Kindle on the contrary is a proprietary format that can only be read on Kindle and devices equipped with the Kindle application. For instance E-books are lent for Kindle by OverDrive, one of the main e-lending platforms, due to an agreement with Amazon. It seems that part of the lending process is to be completed on the Amazon website which led to severe critics as the commercial platform processes personal data of e-borrowers.

<sup>881</sup> The e-books made available for e-lending will not be generic but adapted to the conditions imposed on the lending.

reproductions thereof<sup>882</sup>. Since the on-line lending includes a transmission of a digital file, and not of a tangible item, it should be considered as being outside of the scope of the lending right<sup>883</sup>.

In the proposal for a rental and lending directive, the European Commission referred to “objects (...) which incorporate protected works or performances”<sup>884</sup>, indicating that it had tangible items in mind<sup>885</sup>. The question was addressed in the Council Working Group, during which the Member States did discuss the coverage of electronic rental or lending but decided that they did not want to deal with it at the time, considering that the topic was still premature<sup>886</sup>. Some scholars consider that the purpose of the directive was to cover the entire situation of rental and lending, including electronic forms thereof<sup>887</sup>.

Yet, the inclusion of digital products in the public lending right was not completely closed as demonstrated by later documents from the European Commission. In the Green Paper on Copyright and Related Rights of 1995, it was discussed whether the lending and rental rights may be applied by extension to digital transmissions<sup>888</sup>. It seems that the starting point for the reflection was the application of the rental right to services on demand, such as video-on-demand, that were emerging at the time<sup>889</sup>. In its comparison between traditional lending and new forms of making available on-line, the Green Paper went as far as stating that “the definition [of lending] does, however, cover digital lending by establishments accessible to the public” and the on-line consultation of a work from a public library comes to the same thing as borrowing a copy of the work”<sup>890</sup>. The Commission document nonetheless acknowledges that such an extension should be confirmed in legislation and its details should be spelled out in order to reconcile “the cultural and educational functions of bodies such as public libraries and universities, which have the aim of ensuring the widest possible dissemination of works and data, (...) with the legitimate protection of rightholders”<sup>891</sup>. True, the Green Paper warned against new forms of uses within libraries in respect with the protection of the interests of copyright holders, but still stressed the interests of the different parties concerned: “authors must be able to control the use of their works, libraries must ensure the transmission of available documents and users should have the widest possible access to those documents while respecting the rights or legitimate interests of everyone”<sup>892</sup>. The European Commission then came to the conclusion that “the application of the lending right to electronic transmission should also be reviewed with a view to maintaining a balance between the interests of public libraries and those of rightholders”<sup>893</sup>.

Such a generous position in favour of libraries might seem surprising. It should be reminded that this Green Paper was released at a time prior to the mainstream development of the Internet and without any digital products yet commercially available on-line for consumers, such as e-books or movies. The economic impact or the development of digital libraries could not have been anticipated in 1995.

That view was given up in the Follow-up to the Green Paper in 1996. Even though, it was therein reiterated that on-demand transmissions, such as VOD, enter in the field of application of the rental

---

<sup>882</sup> M WALTER & S. VON LEWINSKI, *op. cit.*, p. 277.

<sup>883</sup> See for a discussion of the different arguments, R. VAN DER NOLL ET AL. *Online uitleen van e-books door bibliotheken, op. cit.*, p. 32-33.

<sup>884</sup> COM (90) 586 final, p. 4.

<sup>885</sup> R. VAN DER NOLL ET AL. *Online uitleen van e-books door bibliotheken, op. cit.*, p. 35.

<sup>886</sup> M WALTER & S. VON LEWINSKI, *op. cit.*, « Chapter 6: Rental and lending rights directive », n° 6.1.28.

<sup>887</sup> J. REINBOTHE & S. VON LEWINSKI, *The EC Directive on Rental and Lending Rights and on Piracy*, London, Sweet and Maxwell, 1993, p. 41-42.

<sup>888</sup> Green Paper on Copyright and Related Rights, COM(1995), 382 final.

<sup>889</sup> *Ibidem*, p. 57-58.

<sup>890</sup> *Ibidem*, p. 58.

<sup>891</sup> *Ibidem*.

<sup>892</sup> *Ibidem*.

<sup>893</sup> *Ibidem*, p. 59.



right<sup>894</sup>, the opinion of most Member States against an extension of the rental right and distribution right to on-line transmission was followed. No reference was made to on-line lending.

The European Commission preferred to cover all forms of on-line transmission, whether on-demand or not, under a broadly defined right of communication to the public, as it was the direction that took the discussion around what would become the WIPO Copyright Treaty of 1996 opted for a right of making available, that would cover on-demand services. The fate of on-line rental and lending as falling out of the box of those rights was sealed. The adoption of the InfoSoc Directive and its communication to the public right should then be considered as being a *lex specialis* for all forms of making available right and would prevail over an extensive interpretation of the rental and lending rights in the earlier directive of 1992<sup>895</sup>.

The recital 40 of the InfoSoc Directive that recommends that acts of making works available on demand by libraries be subject to licensing with rights holders could also be interpreted as rejecting e-lending outside of the right to remuneration for which most Member States opted by transposing the lending directive<sup>896</sup>. However, as we have seen earlier, that recital relates to the exception for some acts of reproduction for libraries and aimed at excluding acts of making available, but does not appear to be connected with lending activities of such institutions.

A further argument against the e-lending in the current state of EU copyright law is the closed list of exceptions in the Directive 2001/29 that would prevent the recognition of any new exception not already listed in the directives in force<sup>897</sup>. This is not a convincing argument. The InfoSoc Directive and the exceptions it provides are without prejudice of existing exceptions by virtue of other directives. Therefore the exception that the Rental and Lending Directive allows Member States to enact a public lending right in the form of a right of remuneration is not affected by the directive on copyright in the information society. The question as to whether it could be extended to a form of lending that relates to the information society (that is governed by the later directive) is uncertain though. It is also worthwhile to remind that the closed list of the article 5 of the directive 2001/29 has not prevented the directive on orphan works to authorize libraries to make such works available. A new exception, not included in the list, has hence been enacted in the European Union *acquis*.

Not all libraries are satisfied with the interpretation against the coverage of off-site lending by the directive 2006/115 and its national transpositions. In the Netherlands the Vereniging van Openbare Bibliotheken (Association of Public Libraries) has brought the matter before the courts. They started a test case against the collective management organisation in charge of the lending right to be allowed to provide e-books in libraries for download<sup>898</sup>.

The UK Government has also commissioned a review of e-lending that has resulted in a recommendation to extend the public lending right to remote e-lending<sup>899</sup>. Following that report, the British Government has announced its intention to make libraries able to offer digital books to their readers, by revising the Public Lending Right in two stages<sup>900</sup>. First, and it was started by the Digital Economy Act of 2010<sup>901</sup>, the Public

---

<sup>894</sup> Communication from the European Commission, Follow-up to the Green Paper on Copyright and Related Rights in the Information Society, 20.11.1996, COM(1996) 568 final, p. 12.

<sup>895</sup> M WALTER & S. VON LEWINSKI, *op. cit.*, n° 6.1.29.

<sup>896</sup> R. VAN DER NOLL ET AL. *Online uitlenen van e-books door bibliotheken*, *op. cit.*, p.37.

<sup>897</sup> *ibidem*.

<sup>898</sup> See [www.informatieprofessional.nl/nieuws/9848-proefproces-om-uitlenen-van-ebooks-door-bibliotheken.html](http://www.informatieprofessional.nl/nieuws/9848-proefproces-om-uitlenen-van-ebooks-door-bibliotheken.html).

<sup>899</sup> W. SIEGHART, *An independent Review of E-Lending in Public Libraries in England*, 2013, [www.gov.uk/government/publications/an-independent-review-of-e-lending-in-public-libraries-in-england](http://www.gov.uk/government/publications/an-independent-review-of-e-lending-in-public-libraries-in-england), 24 p.

<sup>900</sup> DEPARTMENT FOR CULTURE, MEDIA & SPORT, *Government Response to the Independent Review of E-Lending in Public Libraries in England*, 2013, [www.gov.uk/government/publications/an-independent-review-of-e-lending-in-public-libraries-in-england](http://www.gov.uk/government/publications/an-independent-review-of-e-lending-in-public-libraries-in-england), 7 p.

<sup>901</sup> Article 43 of the Digital Economy Act 2010, [www.legislation.gov.uk/ukpga/2010/24/contents](http://www.legislation.gov.uk/ukpga/2010/24/contents).

Lending Right Act 1979 was modified to include audio-books and e-books in the notion of “books”<sup>902</sup>. However this does not extend to the making available of an e-book by means of electronic transmission<sup>903</sup>. Only the provision of e-books on readers should be included in the public lending right when the law will enter into force, which is not yet the case due to financial restrictions<sup>904</sup>. More precisely, “copying or issuing a copy of the e-book as an act incidental to lending it” shall not be considered as infringing the rights conferred by copyright or related rights.

In a second stage, the Government contemplates to enable public libraries to offer remote e-lending services to their readers and to recommend further legislative changes accordingly, while acknowledging that the EU directive 2001/29 probably stands in the way<sup>905</sup>.

As a conclusion, one could say that e-lending is not covered by the Rental and Lending Directive but is a form of making available that should be authorised by copyright and related rights owners in conformity with the InfoSoc Directive.

### 3. The revision of the regulatory framework

The development of e-lending pilots in Member States proves that libraries and readers have an increasing interest in expanding lending to offsite lending. It also shows that the market is ready to provide e-books and other digital products for e-lending services.

But is there a need for a legislative intervention to help libraries to propose on-line lending to their members or rather to regulate it? This Part will first ask whether a legislative intervention is desirable (a.). Then, the type of a possible intervention will be addressed (b.) before examining the conditions that could apply to e-lending (c.).

#### a) The need and opportunity of a legislative initiative on e-lending

The growth of e-lending experiments based on licensing between libraries and publishers, in lack of any certainty as to the status of e-lending, demonstrates that the market is capable of providing literary works, and sometimes other types of cultural content, to libraries and their readers. That does not prevent that some public interest objectives could justify, despite the capability of copyright owners to license their works for offsite lending by libraries, a legislative intervention either to make a limitation of copyright prevail on market-based initiatives or to provide some general frame to the private ordering of public lending.

Our reasoning will be developed in two stages. First, the objectives of public lending and their sustained validity for e-lending will be addressed (i.). In a second stage, one will look at the economic impact of e-lending on the new markets for e-books (ii.). It should be verified whether the rights owners have reason to fear that the development of e-lending by libraries would defeat their exploitation of e-books. This study not being an economic one, only the criteria to take into account will be stressed.

---

<sup>902</sup> The definition of book has been modified as follows : “book” includes (a) a work recorded as a sound recording and consisting mainly of spoken words (an “audio-book”), and (b) a work, other than an audio-book, recorded in electronic form and consisting mainly of (or of any combination of) written or spoken words or still pictures (an “e-book”).

<sup>903</sup> The Act states that the notion of “lent out” (a) means made available to a member of the public for use away from library premises for a limited time, but (b) does not include being communicated by means of electronic transmission to a place other than library premises.

<sup>904</sup> Public Lending Right in England is financed by a public fund, as no fee is asked from readers for books loans.

<sup>905</sup> DEPARTMENT FOR CULTURE, MEDIA & SPORT, *op. cit.*, p. 5 and 7.

**(i) Objectives of lending**

Some objectives of lending persist in e-lending by libraries and can be tied up to the public mission of making works available to the public at large. Libraries' mission is to serve as gateways to knowledge and culture.

The cultural promotion objectives referred to in the provision of the Rental and Lending Directive authorizing Member States to limit the exclusive right of lending are rooted in the need to ensure circulation of works in the public sphere and beyond the mere operation of the market. Public lending right purports to provide access to works in a number of cases, namely:

- Libraries provide **access to works to a larger public of readers**, enabling access by some populations who cannot afford buying all the works they read, view or listen to. This lack of access can be grounded on economic reasons but not only. For instance, libraries will cater to the cultural needs of low-income population, children and teenagers, but also of people having difficulty to move to a bookshop or living in remote places (public lending can then be ensured by mobile libraries or by post), as well as people staying in institutions (e.g. prisons, hospitals, nursing homes,...). More generally libraries complement the commercial offer to making books available to the general public, whatever their financial means or access restrictions to books. They bring authors and readers together in a different way than the market. Many big readers go often to libraries to fulfil their reading habits, while equally buying many books in bookshops and retailers.
- Libraries provide **larger access to works** than the market: as bookshops have only a limited percentage of published books in stock and the average life of a book in bookshops is less than one year, public libraries, through their preservation mission, might offer a more extensive collection, depending on their size and budget<sup>906</sup>. Another limitation of the market in providing books is absent in the way libraries operate. Whereas the market will mostly obey to a demand-rule, libraries tend to choose the works they acquire on other criteria (namely cultural ones, notably a selection of local and national authors), or in an exhaustive way, if they are in charge of legal deposit, which can lead to more cultural diversity in the offer. On the other hand, when an embargo rule is applied to public lending, the offer of newly released books, CDs or DVDs will be more restricted than the market, with due cause, and the readers would be incited to go and buy the newly released book.
- Libraries provide **access to sources for research** (mostly in academic and research libraries) as they hold extensive collections of publications on scientific topics. Researchers who need to consult many sources of documentation could not afford to buy all the relevant books published in their field and rely on consultation within the library, and additionally to lending to get access to the material they need. Academic libraries also provide scientific books to students to carry out research required for specific assignments or papers.

Transposed to e-books and e-lending, these objectives could still be sustained:

- **as to access to works by a larger public of readers**: some segments of the libraries readers will still need access to works by libraries as they could not afford getting access to culture otherwise or only partially. This is the case of younger people, low-income populations, or people in institutions with no access to culture but by the library of such institution (hospitals, prisons, ...). On the other hand, e-lending will require to get access to e-readers which could constitute a new

---

<sup>906</sup> This might read as an excessive statement as libraries will also need space on their shelves and might get read of some books quite regularly. Their collection will be based on the selection of the librarian and not offer everything that exists on the market. The development of on-line retailers, with a larger catalogue and with longer period of availability (and unlimited availability for e-books) has also changed the comparison with libraries.

hurdle to access to culture for some categories of people and increase the cost of access through libraries, except in the case where libraries also provide the device to read the e-book. The libraries' offer of e-books will still play a role in complementing the reading of big readers ;

- **as to access to a broader and extensive offer of content:** Not all works will be offered by the market in e-book format or some e-books might not be commercialized after some time. Libraries could keep their role of preserving works and providing them to the public long after they have been put off the market, even though the development of e-books has also lengthened the period of availability of e-books in a catalogue of a publisher. E-books are in a logic of demand, whereas physical books are based on a logic of offer and depend of the number of copies the publisher decided to print.

Public libraries consider that one of their key missions is to provide to their members with the diversity of commercially published literary and artistic works. E-books will form a significant part of the literary production of the years to come and will sometimes have no paper equivalent. As far as music and movies are concerned, they might be soon be released only as downloadable digital products. Excluding them from the public libraries collection would deprive their users from a significant part of cultural content;

- **as to access for research purposes:** academic and research libraries are accustomed to deal with digital resources. Besides, scientific books or textbooks might be amongst the types of content that will be more systematically proposed in an electronic format. The access to such works for research, that includes episodic lending to researchers or students, will not decrease with the shift to e-books.

Libraries argue for some preservation of their role as providers of culture and information and demand that they could offer e-books under reasonable terms and conditions<sup>907</sup>. The Sieghart Review on e-lending, commissioned by the UK Government, warns that “whatever analysis you make about the impact of remote digital borrowing on the physical footfall in libraries, it is plain that an inability to offer digital lending will make libraries increasingly irrelevant in a relatively short time”<sup>908</sup>. Similarly, the Lescure Report in France acknowledges that libraries constitute a “third sector” for the dissemination of culture and information, between the commercial sector of cultural industries and non-market exchanges between individuals<sup>909</sup>. The key role of libraries in our societies is to guarantee some collective use and dissemination of creation and culture. That does not mean that an exception or limitation should necessarily cover e-lending (a question we will turn to later on), but that the objectives of maintaining some alternative of provisions of books, by the channel of public libraries, is still justified for digital content. The third channel of dissemination of books cited by Lescure, i.e. the sharing between individuals, might also decrease as an e-book, at least in a proprietary format such as Kindle, can usually not be transmitted to someone else.

The public interest role of libraries and the remark of the Lescure Report, considering the libraries as being a third sector in the provision of cultural content, justify in our view that libraries should not be completely left to the market operation. When discussing the public lending right in 1992, most Member States wanted to carve out some space for public libraries from the exclusive right conferred to copyright and related rights holders. It is doubtful that their position will change today and that the public space in which libraries operate be closed for e-lending.

---

<sup>907</sup> See IFLA, *IFLA Principles for Library eLending*, August 2013, [www.ifla.org/node/7418](http://www.ifla.org/node/7418), 3 p.

<sup>908</sup> W. SIEGHART, *op. cit.*, p.8.

<sup>909</sup> P. LESCURE, *Mission « Acte II de l'exception culturelle », Contribution aux politiques culturelles à l'ère numérique*, 2013, [www.culturecommunication.gouv.fr/Actualites/Missions-et-rapports/Rapport-de-la-Mission-Acte-II-de-l-exception-culturelle-Contribution-aux-politiques-culturelles-a-l-ere-numerique](http://www.culturecommunication.gouv.fr/Actualites/Missions-et-rapports/Rapport-de-la-Mission-Acte-II-de-l-exception-culturelle-Contribution-aux-politiques-culturelles-a-l-ere-numerique), p. 185.

What this public space could be in the copyright framework, whether a limitation or exception or some other legislative intervention to facilitate the conditions of licensing or other limitation from a full-fledged exclusivity, will be discussed below.

The necessity to provide a high level of protection to copyright and related rights owners first dictate to look at the other side of the balance and notably to consider the possible impact on the market of the development of e-lending by public libraries. One should add that the economic aspects of e-lending are being considered in a separate study commissioned by the European Commission.

### **(ii) Economic impact of e-lending**

The book publishing industry is the largest cultural industry in Europe and its interests should be preserved. The requirement that copyright legislation ensures a high level of protection of the rights of intellectual property holders entails that e-lending by libraries should not impair the development of new products and business models of this industry in the information society<sup>910</sup>.

It cannot be contested that public lending has an impact on retail sales of books as readers can have access to some book without buying it. However, this individual and potential impact of each act of lending needs to be substantiated and extended to an assessment of the overall impact of lending activities, including e-lending, on the market for e-books and their normal exploitation.

This assessment will help determine on the basis of the three-step test scrutiny whether the e-lending could be allowed under a limitation of the exclusive rights, in the form of a statutory license or another form of limitation with fair compensation, as it is generally the case for public lending, and whether the application of the three-step test precludes an extension of such limitation to the making available of e-books and other digital content. This will be done below when discussing the possibility for an exception to copyright. An economic impact assessment<sup>911</sup> could also provide guidance as to the conditions applicable to e-lending, whether in the form of a copyright limitation or under a specific licensing frame, in order to limit its possible impact on the market for e-books.

It might seem contradictory to admit that the market is capable to provide works for e-lending, as demonstrated by current collaborations between publishers and libraries, and afterwards verify whether e-lending by libraries does not interfere with the normal exploitation of works.

Yet public lending right is a peculiar case, particularly when considering its extension to e-lending. Indeed most copyright exceptions authorize acts of reproduction or communication to the public that are ancillary to another legitimate activity. For instance, works are reproduced to enable their preservation by libraries, extracts of works are communicated to pupils to illustrate teaching or a work is transformed to perform a parody. The provision of the work is authorised under the exception to enable a broader legitimate activity. Comparatively, the very purpose of lending is to provide the work to the user and is hence in direct confrontation with the exploitation of the work on the market. Its normal effect is to substitute to the acquisition of the work. Users get access to works by public lending and are dispensed then to buy the work (even though they might still buy the work after having read it by a library loan).

Public lending by libraries aims at providing an alternative way of getting access to published works for reading, viewing, research, private study or enjoyment. The assessment of the effect of the exception on the market and normal exploitation of copyrighted works is hence delicate as some market substitution will necessarily flow from public lending. Borrowing a book from a library is in direct competition with buying it in a bookshop.

---

<sup>910</sup> European Economic and Social Committee, Book Publishing on the Move, Document prepared for Second Study Group Meeting, Brussels, 2011, quoted by IFLA, *Les fondements du prêt de livres électroniques (E-books)*, *op. cit.*, p.4.

<sup>911</sup> which will be done in a separate study.

It is not sufficient then to affirm that borrowing a book avoids buying it and would necessarily decrease sales of that book<sup>912</sup>, for the very effect of public lending is to act as an alternative to the market. The economic assessment of the impact of public lending should instead focus on the overall competition between lending and retail market. The activities of lending by libraries should not go as far as making the access to books and other copyrighted works through libraries more convenient compared to access from the regular market for such content. The possibility for the copyright owners to deliver the work for lending is therefore not enough to preclude the public lending by libraries under the limitation of the exclusive right (with or without compensation). The lending activities by libraries could not conversely, due to their ease for the users, avert the public from buying works from commercial platforms and publishers.

Such competition and direct substitution between public lending and market acquisition of a work is precisely what copyright owners fear, in the hypothesis of an extension of the current favourable regime of public lending to online downloads by libraries. Such fear should be substantiated by an economic assessment of the effect of e-lending on the overall exploitation of copyrighted works and a balance needs to be found between the key principle in EU law of a high protection of copyright and related rights and the objective underlying the public lending by libraries.

This study, limited to the legal issues of e-lending, could only point at the factors that need to be considered for such an assessment. In a recent study on e-lending commissioned by the Dutch government<sup>913</sup>, economists have distinguished four impacts of lending on the market that should be assessed:

1. the effect of a development of e-lending through licensing which would create new licensing revenues for publishers and authors;
2. the direct substitution between the buying of an e-book through an online commercial platform and its borrowing through public lending ;
3. the indirect positive effect of e-lending on sales of e-books, due to the increased diffusion of e-books in the general public;
4. the indirect substitution between e-lending and sale of published books (as tangible goods).

Publishers mostly argue that the development of e-lending by libraries, under an exception and without their control, could undermine the development of a market for e-books, and indirectly reduce the sales of tangible books, thus referring to the second and fourth impacts listed above.

The second impact should in our view be reformulated. In the Dutch study, it is understood as an investigation as to whether the lending of an e-book by a public library will offer an attractive alternative to its acquisition on the retail market<sup>914</sup>. It will certainly for some people offer an alternative to the market, but the real question is whether, in general and not only theoretically for one book, the e-lending offer by public libraries would have a significant impact on the overall market?

On that basis, an economic study should assess the real competition between libraries and booksellers and the overall effect of public lending on retail sales, notably by taking into account the attractiveness of lending versus buying.

---

<sup>912</sup> Economic studies could also assess whether users of libraries are not buying more books than non users and whether young people having acquired their reading habits in libraries will not become regular customers of bookshops and other retailers.

<sup>913</sup> R. VAN DER NOLL ET AL. *Online uitlenen van e-books door bibliotheken, op. cit.*, spec. p.44.

<sup>914</sup> Not only authors and publishers but also platforms selling e-books could also suffer from the competition created by e-lending, where the cost could be lower (or even inexistent) for the same availability and quality.

This is where e-lending will change the picture of traditional public lending. There are differences between borrowing a physical book at a public library and buying it that still tilts the balance for the readers who can afford to buy a book, towards bookshops, for instance:

- the need of a library membership;
- the need to physically go to a library within its opening hours to check out and most of all, to return the book by its due date;
- the unavailability of books for lending due to a waiting list or to the application of an embargo period;
- the sometimes poor quality of books that have been often borrowed;
- The limited collection of the library, compared to the possibility to order any book from its publisher;
- The lack of unlimited possession and ownership of the book;
- The impossibility to annotate the book or keep it for further reference.

Some of those differences between lending and buying, also called 'frictions', might be attenuated or may well disappear for e-books and on-line delivery<sup>915</sup>:

- The journey to the library's premises is not required anymore, and no specific act of returning the book will occur if it is automatically disabled at the expiration of the lending term;
- The e-lending services will be available 24/7;
- Due to their electronic format, e-books can be sent to several readers simultaneously which could reduce the wait for the book to be available;
- E-books will not wear out by the number of readings;
- Buying a book gives possession of a tangible good to its acquirer whereas borrowing a book from a library is only for a limited time. Even though the same difference exists between a bought e-book and a borrowed e-book, the immateriality of the e-book might reduce the perception of such a difference, as the acquisition of e-books give few elements of possession to the buyer as well. From a legal perspective, the provision of an e-book by download could be defined not as a sale<sup>916</sup> but as the provision of a service, and no transfer of ownership would occur<sup>917</sup>.

Therefore, in terms of comfort, the gap between e-lending and buying an e-book might be reduced which would ultimately have an impact on sales if the modalities of e-lending are not constrained. This will lead to imposing some conditions to e-lending to maintain its lower attractiveness. We will address these frictions when analysing the possible conditions of e-lending in a legislative revision of public lending right.

---

<sup>915</sup> It will depend on the technical modalities that will be chosen for the e-lending model. See below.

<sup>916</sup> That could be challenged by the decision in the *UsedSoft* case (C.J.E.U., judgment of 3 July 2012, C-128/11, *UsedSoft*), if one considers that its reasoning is not limited to computer programs but could be applied as well to e-books or other types of digital content provided online with no limited duration of use. In such a case, on a legal point of view, there would be some difference between a sale of an e-book and a lending in terms of ownership.

<sup>917</sup> The transfer of ownership will depend of the terms of the contract, but it could be perceived in any case as not similar to the transfer of property in a physical object.

In terms of the economic impact of e-lending, the differences between types of libraries could also matter. Indeed the situation of research and academic libraries is rather specific compared to general public libraries. Such libraries are the main market of scientific publishers, in contrast with general publishers who rely mostly on the retail market. This might have an effect of the extent of the substitution effect, as the readers of the research libraries do not constitute the major market for scientific publishers. Fears of piracy are also higher for mainstream books than for scientific ones and academic libraries have a long time habit of managing electronic resources licenses by scientific publishers, two reasons that might give more confidence to scientific publishers to allow for e-lending in research and academic libraries.

### b) The instruments of a legislative intervention

If some legislative intervention to attenuate or limit the exclusivity of copyright and related rights over e-lending is decided, it could take several forms, from an interpretative instrument of existing regulatory framework applicable to public lending, soft law instruments regulating licensing of e-lending to a limitation of copyright and related rights as it is now the case in most member States for the public lending right.

Possible options are:

- **Keeping the status quo:** Not revising the current situation would mean that the public libraries could engage in e-lending only with the authorisation of rights holders. That would give a green light to licensing models to continue to govern e-lending. Such licensing has proven in Europe and elsewhere that it could spur the offer of e-books by libraries. The model put in place by the market also relies on solid infrastructure, both technical and organisational, that is operated by intermediaries playing the role of an interface between publishers, libraries and readers. Libraries do not need to develop or invest in costly technical infrastructures .

Some shortcomings might however be pointed out. Fundamentally, in our opinion, the traditional role of libraries in providing an alternative to get access to cultural content should be preserved in the digital environment and their mission should be extended to the provision of e-books and other digital content. To that end, their autonomy should be preserved. Relying only on the market to deliver e-books to library readers could potentially dictate unreasonable terms and conditions to libraries or transform public lending into another commercial service provided by the publishers. Apparently, this is not the case right now and all studies on the models of e-lending rather show an apparently balanced relationship between libraries, publishers and intermediaries and conditions that seem reasonable and fair both for libraries and for readers. In the United States, though, where the commercial model of e-lending is more developed, some concerns have been voiced about the independence of libraries from the intermediaries and the infringement of some key principles and values applied by libraries, notably concerning privacy issues<sup>918</sup> and some terms imposed by the publishers to the intermediaries<sup>919</sup>.

Another consequence of leaving e-lending to the market is that it could limit the content available for e-lending to e-books that are licensed for that purpose by publishers and would prevent to some extent libraries from deciding which books should be offered to their readers<sup>920</sup>. Some publishers are also reluctant to allow e-lending by libraries and have not developed e-lending models yet. Developing a bigger catalogue of e-books for e-lending while securing the interests of

---

<sup>918</sup> The role of Amazon in authorizing e-lending for Kindle has been regularly criticised as the commercial retailer technically seems to intervene in the operation and can thereby collect personal data of the people borrowing e-books, data related to the borrowed titles and connected to the identification of their Kindle device and Amazon account. See [www.infodocket.com/2011/09/27/8350/](http://www.infodocket.com/2011/09/27/8350/).

<sup>919</sup> <http://librarianbyday.net/2011/02/25/publishing-industry-forces-overdrive-and-other-library-ebook-vendors-to-take-a-giant-step-back/>.

<sup>920</sup> IFLA, *Les fondements du prêt de livres électroniques (E-books)*, op. cit., p. 7.



publishers and libraries alike, could be an argument in favour of some legislative intervention in the field.

- **Adopting a Memorandum of Understanding or Standard Licensing Model for e-lending:** even if the preferred option would be to let the market develop comprehensive licensing for e-books through collaborations between libraries, publishers and dedicated platforms and intermediaries, hence not expanding the limitation of exclusive right to e-lending, some accompanying measures could be considered to regulate the conditions applicable to e-lending licensing.

One mechanism may consist in the drafting of a *Memorandum of Understanding* or Standard Licensing Terms for digital lending. This option is considered by EBLIDA, the European Association of Libraries, with the objective of guaranteeing “Fair Licensing Models”<sup>921</sup>. One key advantage of such soft law instruments would be to integrate the public interest mission of libraries in market-defined licensing terms and devise solutions to facilitate e-lending by libraries while protecting the rights and interests of copyright holders and publishers. It would also have the effect of applying similar conditions to e-lending throughout Europe and for all public libraries, whether important or small ones. Instead of an exception or limitation which, at the European level, cannot include too many conditions, an MoU has the advantage of permitting to be more detailed in the conditions that should apply to e-lending, namely to create some ‘frictions’ as opposed to a normal sale of an e-book. It could also differentiate between the types of works concerned, from e-books to music, films or video games, as well as fiction works or scientific books, the types of libraries, generalist, research or academic or specialised ones, all conditions that will be examined below.

The 2011 Memorandum of Understanding on digitization and making available of out-of-commerce works can already apply to e-lending of such works as it is a form of making available. The Lescure Report, commissioned by the French Ministry of Culture, namely recommends encouraging publishers to apply voluntary collective management to digital lending<sup>922</sup>.

- **Adopting an interpretative document:** the adoption of an interpretative document to the Rental and Lending Directive would not be very useful. Indeed, interpreting the notion of lending as including the making available on line would only recognise that the e-lending is an exclusive right of the copyright owners. It would not impose to Member States to expand the right of remuneration they might have provided in their law to digital lending. Moreover, the scope of an interpretation document should be limited to interpret a current provision whose scope is uncertain, not to extend its scope.
- **Revising the provisions of the directive 2006/115 or the directive 2001/29 to allow for e-lending:**

*As to the principle of an exception:*

Adopting an exception for e-lending, probably in the form of a statutory license with fair compensation for authors, could be justified by the public interest that underlies the provision of access to works that is one key mission of libraries. No market failure happens here as the market is capable to organise and license e-lending, but the copyright limitation would be explained by a market limitation, for normative reasons related to the central role of public libraries.

---

<sup>921</sup> EBLIDA, *European libraries and the challenges of e- publishing. An e-book policy for libraries in Europe*, May 2012, [www.eblida.org/news/european-libraries-and-the-challenges-of-e-publishing.html](http://www.eblida.org/news/european-libraries-and-the-challenges-of-e-publishing.html), 1 p.

<sup>922</sup> P. LESCURE, *op. cit.*, fiche A-13, p. 193.

The current system of lending is not conceived strictly as an exception in the *acquis communautaire*. The directive 1992/100, then codified in 2006, affirms the exclusive right of lending of authors and related rights owners, then allows Member States to reduce it to a right of remuneration. In a last movement, it also permits to national legislation to exempt certain public institutions from the payment of some remuneration.

The enactment of a limitation to the exclusive right is thus left to the discretion of national laws and could take several forms: a right of remuneration granted to authors, a legal license with fair compensation, or in part for exempted libraries, a mere exception with no return to copyright and related rights holders.

From a legislative point of view, the situation is exactly the reverse of the exceptions listed in the article 5 of the directive 2001/29. There, the parameters and boundaries of the exception are imposed to the Member States that cannot extend the exception but could restrict its scope even further. Revising some exception of that list entails, as we have done above for the other exceptions benefiting libraries, to spell out the details of the conditions of the exception that the national law should conform to, in order to increase harmonisation and ensure that the objective of the exception be attainable.

Public lending right is slightly different. The conditions that are enumerated in the directive 2006/115 (as to the beneficiaries, the aim of the making available) are not strictly speaking related to the exception that Member States can opt for, but pertain to the definition of what lending is. It is only indirectly that they become conditions of the limitation/exception when the Member States decide not to implement the public lending right as an exclusive right. Precise conditions for the lending are then determined at national level with no overall European guidance.

As a consequence, the decision to extend the regulatory frame of lending to off-site lending (should this option be chosen) will probably require a legislative intervention that might need to transform the system of an exclusive right that can be qualified and attenuated by the Member States into a limitation of copyright and related rights with precise conditions. This will have some effect on the principle of subsidiarity and on the principle of a high protection of copyright and related rights that should not be neglected.

Another target for revision might be the InfoSoc Directive as the off-site lending is most often considered as an act of making available covered by that later directive. Therefore, creating an exception to such right could be done by inserting a new exception of the list of article 5. However it would create a hybrid system of lending divided into two EU directives. A last solution would be to enact a completely new legislative proposal that would cover lending of tangible copies of works and other subject matter as well as the on-line provision of digital products by libraries.

#### *As to the compliance with the three-step test*

The first criterion of a “special case” in the triple test consists in verifying whether the exception or limitation corresponds to a clearly defined case and pursue some particular objectives<sup>923</sup>. All opinions converge on the view that the requirement stems from a qualitative understanding and favours exceptions that are of public interest<sup>924</sup>. As regards the digital public lending, there is no doubt that public libraries act in the public interest when offering access to works to their readers. Public lending right is furthermore restricted to not-for profit institutions and should not aim at any direct or indirect economic or commercial advantage which pleads in favour of the “special case”.

---

<sup>923</sup> Case C-5/08, opinion delivered by Advocate General Trstenjak on 12 February 2009, *Infopaq International*, paragraph 135. See also Report of the WTO Panel, United States– Section 110 5) of the US Copyright Act, 15 June 2000, WT/DS160/R.

<sup>924</sup> M. SENFTLEBEN, *Copyright Limitations and the three-step test*, Kluwer Law International, 2004, p. 137 ; M. FICSOR, *The Law of Copyright and the Internet*, *op. cit.*, p. 133.

The economic analysis sketched above could help determine whether e-lending conflicts with the normal exploitation of work, which in that case is constituted by the sales of e-books by publishers and on-line bookshops. If the effect of e-lending on e-books market and retail sales is noticeable, that would interfere with the normal exploitation of works<sup>925</sup>. This assessment will also influence the contours of a possible limitation of copyright that would require adopting restrictive conditions that would reduce the possible attractiveness of e-lending over an acquisition of the work on the market.

The last test consists in the absence of an unreasonable prejudice to the legitimate interests of the right holder. As regards to digital public lending, the prejudice caused to the right holders, as already explained, seems to be justified by the public interest the public libraries pursue. That being said, as for the analogue world and in order not to raise discrimination between analogue works and digital works, right holders should perceive remuneration for the public lending exception<sup>926</sup>. Other conditions could apply to e-lending, if governed by a copyright limitation, so as to accommodate the legitimate interests of copyright owners, such as the imposition of release windows or embargo (see below).

### **c) Elements for an extension of the public lending right to e-lending**

Whatever the avenue chosen to include the off-site lending into the activities of libraries, e-lending should not be authorised to such an extent that it would interfere with the normal exploitation of works and decrease the volume of regular sales. The conditions applicable to lending, whether in the frame of a copyright limitation, in a Memorandum of Understanding or in standard license terms, should aim at on one hand not making e-lending similar to downloading an e-book from a commercial website in terms of comfort and ease, and on the other hand at guaranteeing the conditions of a normal exploitation of works.

Public lending through libraries might well supplement the market by acting where the latter knows limitations, but public lending has also intrinsic limitations compared to the market. These are called frictions that need to be maintained for e-lending. For instance:

- Access to works owned by a library will depend of the number of copies and of the simultaneous demand by other readers. Getting the last novel of Harry Potter at the time of its public release, might be easier in a bookshop than in a library. Library readers are accustomed to not getting what they are looking for or having to wait for it.
- The number of simultaneous readers/listeners/viewers of the same book/CD/DVD depends on the number of copies of the work owned by the library, which diminishes the harm to the market for the work.
- The duration of the lending is limited in time, which implies that the comfort of reading is not as large than for an acquired book.
- A library might not have some works whereas, save for out-of-print ones, a bookshop can place an order to the publisher.

When, and if, one decides to transpose the public lending to the digital environment, both the possibilities offered by the technological development and the constraints inherited with the practice of lending in the analogue world should be considered.

---

<sup>925</sup> See also Case C-5/08, opinion delivered by Advocate General Trstenjak on 12 February 2009, *Infopaq International*, paragraph 137.

<sup>926</sup> Such remuneration should compensate the harm done to the authors as reminded by the European Court of Justice (see C.J.E.U., 30 June 2011, *VEWA*, C-271/10, *ECR*, 2011, I-5815)

### **(i) Objectives of the exception**

The objectives of the limitation of lending right for public libraries are not explicit in the directive. They are generally understood as the enhancement of access to culture and for academic and research libraries, promotion of research.

Some objectives could cover e-lending. They do not need to be reminded. Another option would be to define more precisely what objectives for what type of libraries would frame the possible limitation of copyright to permit the making available on-line of digital items by public libraries. Depending on the defined objective, different modalities and boundaries will apply to the activity of lending. E-lending could also be restricted to specific objectives, such as the making available of works to defined segments of the populations who are deprived of a regular access to culture due to some reasons (eg handicapped people, people with reduced mobility, people living in an institution, ...).

That last option would however be in contradiction with the normal mission of libraries to provide access to culture to all. Some works existing only in an e-book format would then be excluded to lending for people that would not enter in those categories.

### **(ii) Beneficiaries**

There is no need to modify the **definition of libraries** that are considered, under EU law, to be eligible to carry out lending under a right to remuneration for rights holders. Only the non-for profit libraries that are publicly accessible should benefit from public lending right.

Nonetheless, the development of e-lending would imply to be capable to secure the making available of works, which requires some technical capacity and a significant information system. Not all libraries have the means to make e-books available. The current development of e-lending relies on **specialised intermediaries** that manage the needed information and technological platforms and ensure the technical protection of e-books that can be transmitted to library users. Should some part of e-lending be authorised outside of the exercise of exclusive right and licensing, a similar outsourcing of the technical and operational act of making the e-book or other type of digital content available might be needed, at least for some libraries. That will require that any regime of e-lending authorises public libraries to have recourse to the services of a third party, that could guarantee the security of the on-line loans offered by the library.

Some **distinction between libraries** can also be relevant. Not all libraries are the same as far as lending is concerned and e-lending could have a different impact depending on the type of library in which it is done. Therefore, different conditions could apply depending on the library. We will highlight this possibility of differentiation when relevant in the analysis of the other factors.

We have already indicated that e-lending could be reserved to some identified categories of **libraries' users**, which would be privileged due to a particular situation, e.g. people living in a remote region, or with reduced mobility. However this sort of restrictive condition runs counter to the normal objective of public libraries.

Libraries normally cater to the needs of the local population. When making e-books available on-line, they would offer their services to the whole world. That explains that current e-lending pilot experiments are restricted either to registered members of a library or to residents of a country. This requirement applies for instance in the Norwegian e-lending project in which the Norwegian literature of the 20<sup>th</sup> century is available on-line for lending to any resident of Norway upon verification of his or her IP address<sup>927</sup>. This restriction to residents of a country or likely users of a local library even though it negates to non-territorial

---

<sup>927</sup> K. VEVLÉ, Welcome to the library Anytime – Anywhere, presentation at the workshop organized by FEP, Helsinki, 10<sup>th</sup> May 2013.

dimension of the Internet, could be justified by the cultural promotion and social objectives of public lending. It could be imposed through a secure log-in.

### ***(iii) Works concerned***

Public lending right only apply to **published works**. This is implicit in the directive 1992/100 but is generally required in its national transpositions. It follows from the fact that by lending, a library distributes a copy of a work in its published format. It should not deliver undisclosed or unpublished works, an activity that could be discussed under the making available by libraries of their collections for research or private study. The possibility for libraries to make their collection available online tends to blur the distinction between the lending of published works and the making available for research and private study that could pertain to any document held by a cultural heritage institution, as demonstrated by the Europeana project.

However, lending, whether occurring offline or online, should strictly be limited to published editions of works, whether books in hard copies or e-books.

An additional question is whether the libraries could be allowed to lend works published in an analogue format but that libraries have digitised or whether lending should be limited to works acquired in a digital version. The principle according to which only published books are subject to lending should entail that the library could only provide e-books that have been published as such. That would however limit the e-lending to digital works that have been created or published (or re-published) in that format. Out-of-print works could not then be transformed by the library into downloadable items for lending purposes, except if libraries get the authorization from copyright owners, possibly under the more favourable conditions laid down by the MoU on digitization of out-of-commerce works.

Another practical consequence of such a limitation to published e-books is the difficulty it would create on a technical level. A paper book is by nature lendable as it only implies to transfer it to the user, hand to hand. Providing a library member with a copy of an e-book requires sending a digital file compatible with the equipment of the user. Some e-books are sold on the market in a proprietary format and with restrictive features that limit the installation of the book on a limited number of devices. Therefore, an e-book that a library will buy in a regular e-books store will probably not be usable in e-lending as it would require to disable the technical restriction to identified e-readers. We will come back to that difficulty.

In the offline world, lending also covered **other types of works** such as audiobooks, phonograms, DVDs, videogames. Current discussions on e-lending tend to be limited to literary works and e-books. Libraries would argue that access to culture is not limited to books and that their mission is to promote culture in all its forms. Making available music or films on-line by e-lending could potentially harm the market for video-on-demand or music streaming services, the practical difference between e-lending and these services appears to be rather thin. Some economic assessment should explore further whether a difference is justified between e-books and other digital content as far as e-lending and its impact on the market for those works is concerned.

Conversely, audiobooks should be treated as e-books, especially as they cater to the needs of visually-impaired people that strongly rely on public libraries to access reading material. The public interest of providing those books to this particular public cannot be rejected and the potential harm to the market would probably be measured in a same way as for e-books.

In our view, an exception of e-lending should not exclude from its scope **works subject to licensing conditions**. It would be too easy for publishers to provide e-books in standard contracts that preclude lending, which would empty the exception of all relevance.

### ***(iv) Authorised acts***

E-lending would necessitate several **acts of reproduction or making available**. To enable lending of e-books installed on e-readers, brought by the user or lent by the library with the work, the library should be

authorised to copy the work on the device and make it available to the patron with the reading device. For remote e-lending, making the work available for download and for a limited time should be allowed, as well as any incidental copying that might prove necessary.

As said above, e-books are released in a DRM-protected format that secure the work to an authorised device and to an authorised user with no possibility of further installation on another e-reader. This raises a difficulty for libraries to undertake acts of reproduction, distribution and making available autonomously. If the lawmaker decides to extend a possible existing limitation benefiting lending by public libraries to e-lending, the exception might be vain if it cannot be exercised by the libraries without the collaboration of publishers or intermediaries. For the sake of technical compatibility, the exception might become irrelevant and recourse to a licensed copy might be the sole option.

Such limitation to copyright should hence impose on publishers the provision of e-books in a format enabling their making available on-line by libraries. That does not mean that such e-books will be devoid of any protection against further use. A non-proprietary or open format does not mean an unprotected format. At least the possibility to making the work available to several users successively should be possible. To achieve such objective, the solution of the article 6(4) of the directive 2001/29 on copyright in the information society could be applied by analogy. This provision encourages the voluntary initiatives of rights holders to allow for some authorised uses of their works, despite the presence of DRM, and imposes to Member States to provide some remedies for the beneficiaries of the exceptions frustrated by DRM in lack of voluntary measures by rights holders<sup>928</sup>. Publishers could be incited to provide interoperable and platform-neutral e-books to public libraries in order to be integrated in their information systems and be capable of online access by the public and reading by with many applications and e-readers.

If the legislative intervention is limited to guarantee fair conditions by the adoption of a Memorandum of Understanding or Standard Licensing Terms, it could provide that the license does not unduly impair the capacity of libraries to undertake the acts necessary to e-lending and that some interoperability should be aimed at.

A recent document of IFLA on the Principles of e-lending licensing further insists that eBook licensing/purchase options must respect copyright limitations and exceptions available to libraries and their users in national law, namely the copying of a portion of the work, the reformatting of the work for preservation purposes if licensed or purchased for permanent access or to enable access for people with print disabilities<sup>929</sup>. This raises the issue of the contracting over copyright exceptions. But fundamentally, this demand underlines that libraries are now increasingly acquiring e-books in licensing terms with the objective of making them available through lending and might have no other copies on which they can undertake their other tasks of preservation or archiving.

### **(v) Conditions**

A first condition that is inherent to the definition of lending is the limitation to acts of making available **not for direct or indirect economic or commercial advantage**. A fee can be required from the user (namely to cover the remuneration for the authors) but should not yield any benefit for the library.

In the e-lending developments based on licensing, a number of **constraints** are applied to the conditions of use in order to replicate the “frictions” that one reader experiment when borrowing a book from a library, instead of buying it on the market. With the objective to mitigate the impact that lending could have on the normal market for books and e-books, the simplicity and comfort of getting a book at a library should not too easily divert readers from buying books. When e-books are concerned, the downloading of a book on a library’s website avoids the trouble of going to the library’s premises to check out the book

---

<sup>928</sup> On that provision, see S. DUSOLLIER, “Exceptions and Technological Measures in the European Copyright Directive of 2001”, *I.I.C.*, 2003, vol. 34, p. 62-83.

<sup>929</sup> IFLA, *IFLA Principles for Library eLending*, *op. cit.*

and most of all to return the book by its due date. Publishers fear that this reduction of friction jeopardizes the development of the e-book market and demand that other constraints be applied to mitigate the apparent simplicity of on-line lending. Other 'frictions' could replicate the traditional restrictions entailed by lending:

- **A limited duration** : this a defining feature of lending, but it could be shorter for e-lending.
- **The limitation of one user per title**: this is the model of one book / one user that prevails on current e-lending services. Libraries can only lend the book to one user at a time for each license it has concluded with the publisher or platform. It does create waiting lists, making the e-lending less attractive than the acquisition of the book at online bookstores. This could be a condition of a copyright limitation for e-lending.
- **emulation of deterioration**: some providers of e-books impose to libraries to renew their license after a certain number of loans to replicate the deterioration of a paper book. This condition is not well accepted by libraries. Its objective is dubious, as the price for an e-book could instead reflect the greater number of uses and loans without any loss of quality.
- It could be imposed to libraries engaging in e-lending to **encourage possibility of purchase** for instance by inserting a hyperlink to web bookshops where the book can be found. This could raise some issues of privacy and data protection. In the United States, Amazon had achieved a deal with Overdrive that is the leader platform for e-lending in libraries according to which a reader will receive an hyperlink towards the website of Amazon where the book she has borrowed would be available for sale. This will also enable Amazon to know which Kindle owners are library borrowers and possibly, which types of books they like to read, which is a very valuable information for the leader in the e-book market. This entails some processing of personal data of libraries patrons that would be strictly regulated under the European Union data protection law. Libraries have also a tradition of being very protective of the privacy of their readers. Therefore any encouragement of purchase of books should be done with the appropriate safeguards and by the libraries themselves.
- **Recourse to technical protection measures**: e-books are products that have been developed and marketed with embedded DRM. Without such a technical protection, the e-lending initiatives developed between libraries and publishers would not have been possible. The digital format of an e-book exposes it to further copying, manipulation and transmission. Therefore, securing and limiting the lending on-line should necessarily be aided by technical measures that prevents printing, copying, further lending, and enforces the principle of a limited duration by disabling the access to the book at the expiration of the term. If e-lending is authorized by a copyright limitation, some technical protection could be imposed to the libraries benefiting from the protection, even though that would create some difficulty and cost for libraries in implementing e-lending. The scope of technically prohibited acts might depend on the type of work (e-book, music or audiovisual file) and on the type of libraries. For instance, one can imagine that borrowing a scientific book for research or study from a research or academic library could allow for printing or copying of limited portions or making notes that could be then extracted from the book.
- **Application of an embargo or windows release period** before a work can be available for e-lending: the principle of a prohibition to lend the work during some period after its commercial release is applied in many national laws on public lending right. The idea is also known in the exploitation of audiovisual works that applies successive dates of availability from the release of the movie in theatres, in DVDs to VOD services. As 75% of the revenues yielded by a book are generated in the first six months after its publication<sup>930</sup>, an embargo period of a few months

---

<sup>930</sup> R. VAN DER NOLL ET AL. *Online uitlenen van e-books door bibliotheken*, op. cit., p. 28-29.

makes the commercial exploitation of a work prevail. New e-books will not be immediately available on libraries' websites for download and a significant part of readers will not wait public lending to get access to their favourite authors. The fixation of an availability date applies in the e-lending models in many countries. For instance, in the United States, the publisher Penguin requires a delay of 6 months before making available e-books to libraries. In Sweden, the embargo is about 3 or 4 months and could be extended to 12 months, as in the Netherlands, it may vary depending from one to three years<sup>931</sup>.

This principle has some downsides though. Such windowing has namely been increasingly given up for audiovisual works as the lack of availability of new releases has resulted in more piracy. However a key difference between movies and e-books is that the film was not available on a legal downloadable format months after its release in cinemas. The first exploitation of a book would be in an e-book format that could be lawfully acquired by a reader. In the United States, the inclusion of recently published materials for e-lending has contributed to increase the demand from the public<sup>932</sup>.

The rule of embargo might not be justified in all cases, namely for scientific works whose e-lending in academic and research libraries could occur sooner as such loans, as seen above, are not in the same competing relationship with sales.

The current EU regime for public lending right admits a derogation from the exclusive right of lending but on the condition of the payment of a **remuneration** (or some form of compensation) to authors and other rightholders. In limited cases, the Member States can even derogate from this obligation of remuneration. If the system of lending is extended to off site lending on the same model than that existing in Member States, a remuneration or compensation should equally be granted to authors for e-lending in Member States that have replaced the exclusive right by a right to remuneration. The CJEU has determined the criteria of such right to remuneration focussing, as in private copying, on the criteria of the prejudice occurred by the authors<sup>933</sup>. The remuneration due to authors might receive a different treatment for analogue or digital lending as the harm is not equal. It could also be foreseen that this right of remuneration (when the Member States has not provided another form of compensation) cannot be waived by authors, similarly to what is provided for the right of remuneration for rental.

#### **(vi) Cross-border dimension**

A territorial application of lending is relevant as libraries tend to provide books or films in the language of their population (except for music to some extent) and are subsidised by Member States to sustain objectives of cultural promotion, that generally stress the need to promote the culture of the country or region and the works in the national language and by national authors.

A limitation of the lending to users who are members of the library or to a verification of the IP address could limit the cross-border demand of e-books. But it would contradict the creation of one European cultural space.

Lending in academic and research libraries should similarly be restricted to the registered members of the library or the affiliated establishments (e.g. school or university). There might be a demand from researchers to get access to content held by academic libraries in other countries, but such access should not be satisfied by e-lending, but rather by interlibrary loans (whose application to e-books should also be considered). The question of remote access to the collection of an academic library would also

---

<sup>931</sup> IDATE CONSULTING, *op. cit.*

<sup>932</sup> IDATE CONSULTING, *op. cit.*

<sup>933</sup> C.J.E.U., 30 June 2011, *VEWA*, C-271/10, *ECR*, 2011, I-5815, paragraph 29.



depend on what is done with the exception of the article 5(3) n) of the InfoSoc Directive allowing for on-site consultation.

### III. The exception for teaching and scientific research

The directive of 22 May 2001 on copyright in the information society, according to its Recital 14, “should seek to promote learning and culture by protecting works and other subject-matter while permitting exceptions or limitations in the public interest for the purpose of education and teaching”. The article 5(3) a) of the directive 2001/29 provides for an exception to copyright and related rights for the sole purpose of illustration for teaching or scientific research. This exception pursues two objectives: first “to reconcile the legitimate interests of the rightholders with the wider goal of access to knowledge”<sup>934</sup> and second, to ensure “an adequate level of protection of exclusive rights and at the same time enhanc[e] the competitiveness of European education and research”<sup>935</sup>.

This report aims at assessing whether the scope of this exception is adequate and appropriate taking into account technological changes and the development of e-learning.

Activities concerned by the exception for teaching on one hand and for research on the other will first be described in this introduction. The assessment of the exception will then be carried out in three parts. The first one will analyze the exception for education and research in the EU directive and its national implementations (A.). On that basis the assessment of the adequacy of the exception for education will be undertaken with a particular emphasis on its cross-border dimension and impact (B.). The same exercise will be done for research purpose (C.) before developing several options to address the possible issues raised by the assessment (D.)

---

<sup>934</sup> Green Paper – Copyright in the Knowledge Economy, COM(2008) 466/3, p. 16.

<sup>935</sup> *Ibidem*, p. 18.

## A. Activities of education and research

Teaching and research may involve numerous uses of copyrighted works<sup>936</sup>, which have only increased in the last decade with the development of the Internet and e-learning. One can distinguish at least the following acts of use carried out in educational or research activities:

### 1. Educational uses

#### By teachers

- a teacher might reproduce works for the preparation of her lessons and include some works as illustration of her presentation, textbook, exercises or any other material she provides to students
- copies of works or extracts thereof can be distributed to students as reading material, as exercises or exams
- a teacher might show some films, display or communicate other types of works to her class as illustration of her teaching or as material to launch a discussion or an exercise
- a teacher might upload copies of her presentations (powerpoint slides) (including copyrighted works, textbooks, reading material or supplementary material, ...) on the web platform dedicated to her teaching (generally operated and hosted by the educational establishment)

#### By students

- students might include copyrighted works in whole or in parts in their assignments, upload and make their assignments available on the webpages of the class, or present them to other students and the teacher in the classroom
- students, and mostly pupils in primary schools, might create webpages or blogs as educational exercises with copies of works illustrating the topic covered by the page
- students might share copyrighted works they find useful for learning with other students in dedicated webpages or forums (or even through social networks)
- students might perform a protected work (a play or some music) as exercises, exams or in school events

#### By teachers or students

- teachers or students might translate some works to prepare or to answer to exercises

#### By institutions

- educational institutions might produce anthologies of works for the students
- educational institutions might host on their servers educational material for e-learning comprising protected works

---

<sup>936</sup> See for instance the list established by V.-L. BENABOU, « L'exception au droit d'auteur pour l'enseignement et la recherche ou la recherche d'une conciliation entre l'accès à la connaissance et le droit d'auteur », in Noyer (J.-M.), *Programme de Numérisation pour l'Enseignement et la Recherche (PNER). Synthèse des travaux : Janvier 1999 – Septembre 2002*, Paris, Maison des Sciences de l'Homme, 2002, n° 18 and 19.

- educational institutions, on their own or in collaboration with other schools or universities, might deliver on-line teaching without any physical meeting between teachers and students, such online courses comprising extracts or whole works or other protected subject matter.

Such activities will happen either in the classroom in face-to-face teaching or at distance, using more traditional technologies such as broadcasts or recordings or, in an increasing manner, digital technologies (e.g. smart boards etc.) and networks (e-learning). Those discrete uses might imply some reproduction, communication, making available and distribution of protected works and other subject-matter. Different acts will be done by teachers, students or any other personnel of the educational institution (e.g. teaching assistants, secretarial or administrative staff, as well as in universities by offices dedicated to support educational activities...).

**E-learning** can be developed as a supplementary tool offered to students enrolled in a course (webpages storing teachers' presentations, textbooks, reading material, discussion forums, assignments, ...) or can be provided as stand-alone virtual modules to students registered only for online learning activities. An additional feature of e-learning activities is its possible **cross-border dimension**, as the students might be residing in other countries than that of the institution or teacher providing the courses. Moreover e-learning programs can be offered jointly by a number of universities or schools established in different countries and transmissions of content can reach students in a great number of locations. A recent development in distance learning, called MOOCs for Massive Open Online Courses, brings such educational services to a new level. "Massive" refers to the huge number of students following the course, a number that can go up to more than 100.000 students. The program is said to be open as it is based on open access principles and does not require any tuition fee. The course is fully taken on-line as there is usually not prior connection between the students and the university delivering the course. First initiated in the US in 2011, MOOCs are a new hype in distance learning that is also unfolding in Europe, generally by collaborations between universities.

From a copyright point of view, MOOCs will raise two specific issues: the open access thereto does run counter to the requirement of the dissemination of the educational material to a limited number of enrolled students, as well as the cross-border dimension that will be particularly intricate, given its potential for global reach.

## 2. Research uses

Uses of copyrighted works or other protected subject matter in research activities will be both similar and different from educational uses. Researchers will use two categories of material for research. On one hand, works constitute a topic for research and will be reproduced or communicated for that purpose. For instance, an art historian might use copyrighted artistic works in her research, a researcher in linguistics will analyse an important corpus of literary works, a researcher in cultural studies will need to reproduce and use contemporary cultural content. On the other hand, all researchers, irrespective of their disciplines, will use scientific papers and articles published in their field. In some academic fields, researchers will have regular recourse to databases comprising data, works or other information, as basic material for research, mining or statistical purposes<sup>937</sup>. This distinction could separate the use of copyrighted works as **subject matter for research** from the use of scientific works as **tools for research** and would be relevant for this study as it could elicit some different effects.

### Use of works as subject matter for research:

---

<sup>937</sup> For an overview of research activities including copyrightd works, see J. REICHMAN & R. OKEDIJI, "When Copyright Law and Science Collide: Empowering Digitally Integrated Research Methods on a Global Scale", 2012, *Minn. L. Rev.*, vol. 96, p. 1362-1480.

- Researchers might reproduce works to analyse them or use them as illustrations, include them in their research papers, publications or conference presentations
- Researchers might share protected works with colleagues through the Internet in the context of collaborative research
- Researchers might use digital mining techniques to process huge amounts of texts or data. For instance, researchers in linguistics might analyse a great number of texts to find the frequency of some words or formulations. Such text and data mining is the topic of another study to be delivered to the European Commission.

Use as scientific works as tools for research:

- Researchers might make copies of scientific papers or even share them with colleagues within the frame of a research project
- Researchers might extract data from datasets for analysis and research
- Research institutions might organise repositories of scientific works of their researchers and make them available within the institution or even towards a broader public

### 3. Intersection between education and research activities and copyright exceptions

It should be pointed out that all uses listed above to illustrate the context of educational and research activities do not necessarily imply an act covered by copyright, or that they should necessarily be covered by an exception. They only aim at depicting the broad range of activities that teachers, learners and researchers are likely to engage in within their educational and research activities. In most cases, those uses imply an act of reproduction, communication, making available or distribution. They are carried out with analogue or digital means and might occur on digital networks. Performance within a classroom is aimed at a public, even if it is restricted to a limited number of enrolled students, the assembly will be considered in many Member States as not qualifying as a family circle or a private audience exempted from copyright application. It will also qualify as a public under the European case law that defines the public as a an indeterminate and fairly large number of people<sup>938</sup>. Students accessing contents through e-learning programmes will similarly considered as a public even if they are in the privacy of their homes and receive the content in separate places and at different times.

Depending on the international, European and domestic laws, different limitations to copyright apply to the use of works by schools, teachers and students, some being specifically provided for teaching purposes, others having a sufficiently broad scope to apply also to learning activities. For instance:

- **use for illustration of teaching:** copyrighted works can be reproduced or communicated to the students for purpose of illustration of teaching. This exception, as we will see, exists in the earlier versions of the Berne Convention and is included in the list of the article 5 of the InfoSoc Directive;
- **use for scientific research:** the use of illustration for teaching is often accompanied by an extension to research purposes. The purpose of research is mentioned in the Berne Convention, the EU directive 2001/29 and in many national laws.
- **use for exams:** a specific exception covering the use of copyrighted works as material for exams sometimes appears in domestic laws

---

<sup>938</sup> See C.J.E.U., Judgment of 7 December 2006, C-306/05, *SGAE, ECR*, 2006 I-11519, paragraph 37; C.J.E.U, Judgment of 15 March 2012, C-135/10, *SCF*, paragraphs 85-87.

- making of **anthologies for education**: a second specific exception for education aims at authorizing the making of teaching material by reproduction of works in anthologies or textbooks to be used in classrooms<sup>939</sup>
- **use of works during school activities**: An exception to copyright is sometimes provided in order to allow the performance of works during school events or activities upon the condition that such performance does not have any commercial purpose and is done for free. The performance could serve as illustration of the teaching, as an exercise (like the staging of a play by students) or even for mere entertainment purposes<sup>940</sup>.
- **quotation**: the quotation exception might be the most common exception in copyright laws around the world, due to its (probable) mandatory character in the Berne Convention<sup>941</sup>. The purpose of education and teaching is generally one of the motives justifying the quotation.
- **private copying** and **reprography**: Arguably, copying by students in their learning process might qualify as copying for private purposes. In addition, many acts of reprography could occur during learning or research activities. In some domestic laws, the compensation system for reprography is organised separately for acts of photocopying occurring in schools or libraries.
- **library exceptions**: learning activities can also rely on exceptions benefiting libraries that authorise making available or copying for private study and research.

This study will be limited to the exception of the article 5(3) a) allowing use of works and other protected subject matter for illustration of teaching and for scientific research.

---

<sup>939</sup> M IGLESIAS, *Limitaciones docentes a la propiedad intelectual: derecho internacional español y comparado y opciones de política legislativa*, tesis doctoral, Phd of the Universitat de les illes Balears, Facultat de derecho, Palma de Mallorca, 2007, p. 24.

<sup>940</sup> This last purpose will generally not be allowed under the exception, when existing.

<sup>941</sup> There is some controversy as to its mandatory character. The English version of the Convention says that "It shall be permissible to make quotations from a work" whereas the French language is more explicit as it states that "Sont licites les citations tirées d'une œuvre". An argument in favour of the mandatory nature of the exception is that other exceptions mentioned in the Berne Convention are left at the discretion of contracting States.

## B. The exception for education and research

### 1. The international framework

#### a) The exception in the Berne Convention

Teaching is one of the few exceptions listed in the Berne Convention and was present in the international text since its adoption in 1886. The exception though is a matter for national legislation. In its current version, the article 10(2) of the Berne Convention states that:

“(2) It shall be a matter for legislation in the countries of the Union, and for special agreements existing or to be concluded between them, to permit the utilization, to the extent justified by the purpose, of literary or artistic works by way of illustration in publications, broadcasts or sound or visual recordings for teaching, provided such utilization is compatible with fair practice.

(3) Where use is made of works in accordance with the preceding paragraphs of this Article, mention shall be made of the source, and of the name of the author if it appears thereon.”

This provision dates back from the 1967 Stockholm revision of the Convention. The original exception enabled the States to allow “the liberty of extracting portions from literary or artistic works for use in publications destined for educational or scientific purposes, or for chrestomathies”.

A key evolution was the enlargement from “*portions of works*” to simply works, even though the addition of “to the extent justified by the purpose” could result in limiting the use of works to parts thereof where the *in extenso* copying is not necessary<sup>942</sup>.

As to the apparent restriction to uses by way of publications, broadcasts or audiovisual recordings, all commentators acknowledge that it should not entail a restrictive interpretation. The subsequent revisions of the Berne Convention all aimed at enabling educators “to take full advantage of the new means of dissemination provided by modern technology”<sup>943</sup>. It should not thus be construed to be limited to the techniques referred to<sup>944</sup>.

The objective of the exception should be the “illustration for teaching”. This formulation has replaced earlier versions that referred to “educational or scientific purposes” (original text of 1886). This modification did not narrow the scope of the exception in any way. At the Stockholm conference, the concern was rather related to the amount of a work that could be used for education purposes<sup>945</sup>. As no consensus could emerge on the most accurate wording (that hesitated between ‘portions’, ‘short extracts’, ‘excerpts’ or ‘borrowings’), the terminology of ‘illustration’ was opted for to ensure that, with the suppression of any quantitative restriction, the use was indeed limited to illustrate the teaching<sup>946</sup>. The notion of illustration for teaching is more open-ended as it would not preclude the use of the whole of a work if necessary for proper illustration, for instance in the case of an artistic work or a short literary work.

---

<sup>942</sup> M. IGLESIAS, *op. cit.*, p. 125 ; S. RICKETSON & J. GINSBURG, *International Copyright and Neighboring Rights. The Berne Convention and Beyond*, vol. I and II, 2<sup>nd</sup> ed., Oxford, Oxford University Press, 2006, §13.45.

<sup>943</sup> S. RICKETSON & J. GINSBURG, *op. cit.*, §13.45, p. 793. See the discussion of different interpretations in M. IGLESIAS, *op. cit.*, p. 125-127.

<sup>944</sup> R. XALABARDER, *Study on Copyright Limitations and Exceptions for Educational Activities in North America, Europe, Caucasus, Central Asia and Israel*, WIPO, November 2009, [www.wipo.int/meetings/en/doc\\_details.jsp?doc\\_id=130393](http://www.wipo.int/meetings/en/doc_details.jsp?doc_id=130393), p. 14.

<sup>945</sup> See WIPO (1976), Reports on the Work of the Five Main Committees of the Intellectual Property, Conference of Stockholm 1967, WIPO Publication 309(E), p. 93-94. See also S. RICKETSON & J. GINSBURG, *op. cit.*, §13.45.

<sup>946</sup> M. IGLESIAS, *op. cit.*, p. 129.

“Illustration” indicates at least some link between the teaching purpose and the use of third parties works, both as to its need and extent. The use of the work should be subsidiary to the teaching<sup>947</sup> and serve to give example, explain or support it.

“Teaching” under the Berne Convention is understood as applying at all levels of the educational systems, from elementary schools to universities<sup>948</sup> and includes both public and private institutions. According to most authors, adult education courses appear to be excluded from the exception<sup>949</sup>.

This presentation would not be complete without a brief reminder of the ‘minor reservations’ doctrine. Failing the introduction in the Berne Convention itself of a list of exempted uses, due to the diversity of exceptions in domestic laws, a formal declaration was made in the Report of the Brussels Conference to confirm that exceptions and limitations to the exclusive rights are available to national legislation<sup>950</sup>. This declaration explicitly listed ‘the needs of child and adult education’ as an example. This allows domestic laws to provide for other educational exceptions to the extent they are *de minimis* and comply with the three-step test.

## b) Exceptions for education and research in other international treaties

The Rome Convention on Related Rights of 1961 similarly includes an exception for teaching and research. Its formulation is shorter than in the Berne Convention as it refers to “use solely for the purposes of teaching or scientific research”<sup>951</sup>. It also appears narrower due to the presence of ‘solely’. However, as it is anterior to the revision of its counterpart in the Berne Convention, this difference in the wording is probably irrelevant.

Education and research have then repeatedly stressed in the Preambles of all the ensuing Treaties in Copyright or Related Rights as elements of the balance that copyright should achieve. Both the WIPO Copyright Treaty and the Beijing Treaty on Audiovisual Performances include in the public interest element of the balance “education, research and access to information”. More recently, the Marrakesh Treaty<sup>952</sup> replicates the same formula and insists of the enjoyment by persons with visual impairments “of the right to education, and the opportunity to conduct research”.

## 2. Education and research exception in the EU *acquis communautaire*

Exceptions for educational and research purposes are found in three European directives. Beyond the InfoSoc Directive that will be the object of our study, the article 10(1) d) of the Rental and Lending Directive allows Member States to limit related rights for “use solely for the purposes of teaching or scientific research” and the articles 6(2) b) and 9(b) of the Database Directive, respectively for copyright and *sui generis* right, admit an exception for the purpose of illustration for teaching or scientific research.

The wording of the exception in the Rental and Lending Directive is similar to that laid down in the article 5 of the InfoSoc Directive, except that it does not mention ‘illustration’ but simply ‘use for the purpose of teaching’.

---

<sup>947</sup> See Main Committee I, Summary Minutes, Records of the Stockholm Conference, 1967, p. 885 : “the text proposed by the Group no longer referred to borrowings, but spoke of the utilization of literary and artistic work “by way of illustrations”, which has to be understood in the sense of *subsidiary* reproduction”.

<sup>948</sup> Main Committee I, Report, Records of the Stockholm Conference, 1967, p.1148.

<sup>949</sup> S. RICKETSON & J. GINSBURG, *op. cit.*, §13.45, p.793; M. IGLESIAS, *op. cit.*, p. 133; R. XALABARDER, *op. cit.*, p. 14.

<sup>950</sup> WIPO (1951) *Documents for the Conference of Brussels 1948*, p.100.

<sup>951</sup> Article 15(1) d) of the Rome Convention for the Protection of Performers, Producers of Phonograms and Broadcasting Organizations, 1961.

<sup>952</sup> Marrakesh Treaty to facilitate access to published works for persons who are blind, visually impaired, or otherwise print disabled, June 2013.

The exception to copyright in the database refers to the 'sole' purpose of illustration for teaching, which appears at first sight as being more restrictive than its counterpart applying to the *sui generis* right that does not include this adjective.

Another difference between the exceptions applicable to the copyright or *sui generis* in the Database Directive lies in the fact that any use is exempted from copyright, which is interpreted as referring to all exclusive rights granted by the directive under copyright<sup>953</sup>, i.e. reproduction, communication to the public and distribution whereas only the act of extraction is as far as *sui generis* right is concerned. As a result, online transmission of a database for educational purpose would be considered as infringing the *sui generis* protection of its contents even though the Member States can exempt the transmission of the structure of the database from copyright protection for the same purpose. As 're-utilization' is defined by the directive as "any form of making available to the public all or a substantial part of the contents of a database by the distribution of copies, by renting, by on-line or other forms of transmission", the limitation of the exception to the sole extraction makes it rather useless for teaching as the use of a database to illustrate some course will necessarily require its making available or distribution to the classroom, hence to a public<sup>954</sup>.

Additionally, recital 51 of the database directive leaves to Member States the possibility to restrict even further the exception to the *sui generis* right to "certain categories of teaching or scientific research institutions", without stating any criteria for such a limitation.

### 3. The exception in the directive 2001/29

Article 5(3) a) of the directive on copyright in the InfoSoc Directive of 2001 leaves at the discretion of Member States the adoption of an exception covering the "use for the sole purpose of illustration for teaching or scientific research, as long as the source, including the author's name, is indicated, unless this turns out to be impossible and to the extent justified by the non-commercial purpose to be achieved".

This exception is worded in a very open-ended manner as it does not give any specifications or limits in any way the beneficiaries or the works or protected subject matter concerned. The key factor circumscribing the exception is its purposes: illustration for teaching or scientific research.

#### a) Objectives

##### (i) *Illustration for teaching*

The exception exempts uses 'for the sole purpose of Illustration for teaching'. This objective runs parallel with the exception of the article 10(2) of the Berne Convention.

The purpose should be **solely** illustration for teaching. Reference to 'sole' was already qualifying the similar exception in the rental and lending directive ('use solely for the purposes of teaching') and in the database directive (the adjective 'sole' being applied only to the exception to copyright, but not to *sui generis* right). It entails that a use that would pursue several objectives including illustration for teaching would not be privileged under article 5(3) a)<sup>955</sup>. It does not restrict any further the exception.

The notion of '**teaching**' is not defined in the directive. It can be interpreted as under the Berne Convention as referring to schools at all levels of education. The directive in its recital 14 also refers to education that it places aside of teaching. Indeed that recital provides that "this Directive should seek to

<sup>953</sup> S. VON LEWINSKI & M. WALTER, *op. cit.*, 9.9.10.

<sup>954</sup> E. DERCLAYE, *The Legal Protection of Databases. A comparative analysis*, Cheltenham, Edward Elgar, 2008, p. 131; M. IGLESIAS, *op. cit.*, p. 271.

<sup>955</sup> M. WALTER & S. VON LEWINSKI, *op. cit.*, §11.5.48.



promote learning and culture by protecting works and other subject-matter while permitting exceptions or limitations in the public interest for the purpose of *education and teaching*". There is no explanation in the text of the directive or in its preparatory acts of the difference between the two notions. Two interpretations can be tempted. The first one would be to relate education to the process of getting knowledge while teaching would instead refer to the imparting of knowledge. As a consequence the exception of the directive would be limited to use of works by teachers only, excluding uses by students and pupils. Another interpretation would be to define education as referring to any type of training, schooling or instruction, regardless of the institution or persons providing it and the situation and age of its recipients. Conversely, teaching would designate the institutions recognised by the State, such as schools, colleges or universities, to deliver education. In that case, adult education might be excluded from the scope of the directive. Both interpretations result in a narrower notion of teaching compared to education.

Lacking any indication in the preparatory acts as to the possible meaning of the two words, one could look into the several language versions of the directive. It reveals that the opposition between education and teaching is not as straightforward in the other EU languages. Two different words have also been used in the many versions ('éducation et enseignement' in French, 'fini educative e d'insegnamento' in Italian, 'onderwijs en scholing' in Dutch, 'fines educativos y docentes' in Spanish, 'Ausbildung und Unterricht' in German) but they do not mirror exactly the English words, are being used more interchangeably or loosely or are sometimes accompanied by a third word ('scopo didattico' in Italian, 'educatieve doeleinden' in Dutch). For instance many versions of the directive (e.g., the Spanish or Dutch ones) have opted for a reference to 'education' in the text of article 5(3) a) which can be understood in a broader sense than the notion of teaching used in the English, German or French text<sup>956</sup>. The European Parliament also considered 'education and learning' during the legislative process of the directive<sup>957</sup>.

This seems to indicate that, during the process of adoption of the directive, education and teaching were viewed as synonyms and should still be.

Some questions subsist though as to the proper scope of 'teaching' as referred to in the article 5(3) a) (and of similar expressions in the other language versions).

Most scholars consider that in any case adult education is disqualified<sup>958</sup>, as preparatory work of the Berne Convention, from which the notion of teaching is taken, only refers to "educational institutions and universities, municipal and State schools, and private schools" but excludes "education outside these institutions, for instance general teaching available to the general public but not included in the above categories"<sup>959</sup>. Adult education would be covered however if performed by the schools and universities referred to<sup>960</sup>.

S. von Lewinski also affirms that the use of works for exams would not be encompassed by 'teaching' as the latter refers in its ordinary meaning, to the "conveyance of knowledge or experience to others"<sup>961</sup>. Such an interpretation would be very restrictive and theoretical. All teachers know that the process of examination takes an essential part in the teaching and has didactic purposes. Consequently, using works for exams should definitely belong to a teaching activity, even though the supplementary condition of illustration might restrict what could be done during an exam.

---

<sup>956</sup> M. IGLESIAS, *op. cit.*, p. 223.

<sup>957</sup> See Report of the EP Committee on Legal Affairs and Citizens' Rights, of 28 January 1999, A4-0026/1999, p. 43, amendments 18 and 24.

<sup>958</sup> S. RICKETSON & J. GINSBURG, *op. cit.*, p. 793 ; R. XALABARDER, *op. cit.*, p. 14 and footnote 15 ; S. VON LEWINSKI, *International Copyright Law and Policy*, Oxford University Press, 2008, §5.171.

<sup>959</sup> Records, 1967, 1148. This is criticised by S. RICKETSON & J. GINSBURG, *op. cit.*, p. 793, 13.45.

<sup>960</sup> By contrast, adult education is comprised in the broader limitations allowed to Developing countries under the Annex to the Berne Convention. See S. RICKETSON & J. GINSBURG, *op. cit.*, Vol. II, § 14.25.

<sup>961</sup> M WALTER & S. VON LEWINSKI, *op. cit.*, p. 1043, 11.5.47.

For the same reason, our opinion is that 'teaching' should not be construed as to limit itself to the use of works by teachers, but should cover as well uses of works that are undertaken by students and pupils during the course of their learning process, provided that such use remains within the limits prescribed to the exception and namely the restriction to 'illustration'. By reason of the undecided terminology of education or teaching that the many languages of the directive reveal, all actors of the education process, teachers and learners alike, could be considered as taking part in the teaching. Peer-education, i.e. an educational process in which students interact with other students and learn from each other, is also playing an increasing role in teaching methodologies. A distinction between teachers and students for the application of the exception would hence be discriminatory. Some uses of works and other subject matter by pupils could be covered by other exceptions such as private copying or quotation. Nevertheless, the notion of 'teaching' is broad enough to encompass uses by students too<sup>962</sup>. The activity of 'teaching' "includes the use of works as part of a lesson (...) or an exercise (...) but also a reading (...) to write a paper, or to participate in debate, or simply to study"<sup>963</sup>.

Beyond those precisions, the broadness of the 'teaching' means that it can take several forms, for it does not only include face-to-face teaching, but also distance instruction, including online courses. Recital 42 of the directive specifically refers to distance learning.

The exception of the directive restricts the use of the works to **illustration** of such teaching. According to Article 10(2) of the Berne Convention, such illustration could consist in "publications, broadcasts or sound or visual recordings". Contrary to what this enumeration tends to indicate, all commentators agree that the technical means listed in the article 10(2) are only examples of media that could be used by teachers during the educational process. At the time of the Stockholm conference, which adopted that text, those were the techniques that came to mind and raised concern<sup>964</sup>. But any means and media (e.g., showing, performing a work or an excerpt thereof, including it in a powerpoint presentation, ...) would be covered as well. It is even clearer in the EU directive that does not mention specific means or techniques for the exempted illustrative use.

'Illustration' itself is not defined. In its ordinary meaning, illustrate means "to clarify something by giving, or serving as, an example or a comparison". In an educational context, it could be understood as allowing the teacher to reproduce or otherwise use a work "as an example"<sup>965</sup> illustrating the topic of her course, as well as providing material to better explain or apply the teaching. An illustration can be exemplative, demonstrative, explanatory, for application or for clarification.

The work or any other subject matter used for illustration has to be related to the lesson given to the students, in the sense that a link needs to exist between the work used and the topic of the lesson. The link can be direct when the teaching is about the work. For instance, extracts of writings by philosophers can serve to explain a course of contemporary philosophy; reproduction of paintings can be showed to students in an art history class; reproduction of copyrighted works that have been the matter of a litigation can illustrate the teaching of the court decision in a copyright course.

But illustration could also in our view comprise the provision of works as tools or materials to understand better a more abstract element that is taught. The link would be more indirect then. A teacher could use extracts of novels to explain grammar or make a dictation exercise; writings can be translated in class or pop music can be listened to when learning a foreign language; works of art can be shown to students to

---

<sup>962</sup> CH.GEIGER et al., *op. cit.*, p. 231, esp. p. 241.

<sup>963</sup> R. XALABARDER, « On-line teaching and copyright : any hopes for an EU harmonized playground ? », in P. TORREMANS (ed.), *Copyright Law, A Handbook of Contemporary Research*, Cheltenham, Edward Elgar, 2007, n° 15, p. 384.

<sup>964</sup> S. RICKETSON & J. GINSBURG, *op. cit.*, p. 793, 13.45.

<sup>965</sup> M WALTER & S. VON LEWINSKI, *op. cit.*, n° 11.5.39.

exercise copying their style or technique. It could go as far as to provide further materials to students to prepare a lesson, as a list of required readings<sup>966</sup>.

Actually, as the condition of ‘illustration for teaching’ was taken from the language of the Berne Convention, it should be reminded that such wording was intended to substitute to uneasy discussions about the length of the work that could be used (extracts, excerpts or borrowings were proposed by Delegates at the Stockholm conference). Therefore, it should not be given a too restrictive interpretation, for it was not aimed at limiting the scope of the exception for teaching that existed until then<sup>967</sup>.

The condition of illustration may be interpreted differently depending on the types of works used. Indeed, “while this wording allows the use of entire works such as photographs or poems, the condition of ‘illustration’ is limiting in principle; to illustrate a lesson, it will often be sufficient to use a part of a work only<sup>968</sup>. The taking of a whole work could be appropriate in some circumstances<sup>969</sup>”.

Therefore, illustration could be more than quotation, both as to the extent of the borrowing as to its purpose<sup>970</sup>. Quotation is allowed under another exception of the directive 2001/29 for purposes such as criticism or review, and many Member States have listed ‘education’ in the purposes allowed for quotation. The two exceptions might overlap in some circumstances.

### **(ii) Scientific research**

Article 5(3) a) also refers to uses of works in the context of “scientific research”, without defining such notion. The notion of research has maybe appeared so self-evident that there was no need to define it<sup>971</sup>. Likewise, scholarly articles focusing on ‘research’ exceptions in the InfoSoc Directive have generally not bothered to elaborate a definition of the notion<sup>972</sup>.

No help can be found in the Berne Convention on the notion of ‘research’ as it has been deleted in the Stockholm revision at the time of introduction of the three-step test in the Berne Convention. The triple test was supposed to cover *inter alia* the use of scientific literature for research purposes, removing the need to maintain an express reference to “research” in another provision of the Convention<sup>973</sup>.

An important case decided by a WTO Panel concerned the Canadian exception for research in patent law, but the decision does not define the notion of ‘research’ anywhere in its long decision<sup>974</sup>. Some countries apply an exception to patent for research purposes but without a clear definition of the notion. In the patent field, the exception regularly oscillates between strict scientific goal, defined by G. van Overwalle as “aimed at expanding knowledge or testing a proposition<sup>975</sup>” and a “mixed scientific and commercial goal aimed at developing new applications, improving therapeutic effects, more effective

<sup>966</sup> in favour of this interpretation, see M. IGLESIAS, *op.cit.*, p. 225 ; R. Xalabarder, “Copyright and Digital Distance Education”, 26 *Colum. J.L. & Arts* (2002-2003), p. 143-145.

<sup>967</sup> R. XALABARDER, On-line teaching and copyright: any hopes for a harmonized playground, *op. cit.*, p. 384.

<sup>968</sup> *Ibidem*.

<sup>969</sup> S. RICKETSON & J. GINSBURG, *op. cit.*, p. 791, 13.45.

<sup>970</sup> See the discussion in S. RICKETSON & J. GINSBURG, *op. cit.*, p.790-791, quoting the Documents of the 1948 Brussels Conference Revising the Berne Convention.

<sup>971</sup> See. H. REICHMAN & R. L. OKEDIJI, *op. cit.*; S. RICKETSON & J. GINSBURG, *op. cit.*, 782, § 13.34.

<sup>972</sup> See notably, M. DE COCK BUNING, L. BELDER & R. DE BRUIN, “Research exception in EU Copyright Law”, *European Review of Private Law*, 2012, p. 933-960 ; R. HILTY, “Copyright law and scientific research”, in P. Torremans (ed.), *Copyright Law - A Handbook of Contemporary Research*, Cheltenham, Edward Elgar, 2007, p. 315 - 354.

<sup>973</sup> S. RICKETSON & J. GINSBURG, *op. cit.*,

<sup>974</sup> WTO Panel Report , *Canada – Patent protection of Pharmaceuticals Products*, WT/DS114/R, 17 March 2000.

<sup>975</sup> G. VAN OVERWALLE, “Implementation of the Biotechnology Directive in Belgium”, *IIC*, p. 907.

production methods<sup>976</sup>. The recent Proposal for Regulation for the Unitary effect patent has opted for the second option by enacting a limitation of the exclusive rights for acts done for experimental purposes relating to the subject-matter of the patented invention<sup>977</sup>. Analogy with research in patent field is not really transposable to copyright as inventions are used differently.

In a reference manual of OECD on research and R&D, research and experimental development are defined as “creative work undertaken on a systematic basis in order to increase the stock of knowledge, including knowledge of man, culture and society, and the use of this stock of knowledge to devise new applications”<sup>978</sup>.

Directives prior to the InfoSoc Directive of 2001 also referred to scientific research with the same imprecision. The objective of research appears in the article 10(1) d) of the Rental and Lending Directive and in the articles 6(2) b) and 9(b) of the Database Directive. The latter directive explains in a recital that the term ‘scientific research’ covers both the natural sciences and the human sciences, a precision that seems to have resulted from different meanings of ‘science’ in the many languages of the European Union<sup>979</sup>.

Concerning the meaning of ‘**scientific research**’, the addition of ‘scientific’ probably refers to more than research, in the sense it has to be “carried out in a methodological and systematic way”<sup>980</sup>, but one could also presume that all research is by definition scientific.<sup>981</sup> When the European lawmaker wishes to refer to research made by individuals outside of a scientific purpose, it has recourse to the term ‘private study’. For that matter, some domestic laws, when implementing the directive, have dropped the adjective ‘scientific’, on the basis that research is necessarily scientific. This was the case in the UK where this argument was explicit<sup>982</sup>. Another interpretation of ‘scientific’ would be to understand it in opposition with commercial research, but then it would only repeat the requirement that the research be done for non-commercial purpose. Actually this is rather the articulation of research with the condition of non-commercial that might be difficult to apply in practice. What is clearly excluded is research made by a commercial company, even if it uses scientific methods. But what about research undertaken by an university but with private funding by a company that intends to develop commercial products out of the research? What about research made by a spin-off of an university? What about research in Government<sup>983</sup>?

The addition of the ‘**solely**’ limitation to the purpose of scientific research allowed entails that the use of the work for any other purpose falls outside of the exception. However that could not disqualify ancillary acts of research such as publication of outcomes in a scientific journal or in any other publication<sup>984</sup> to the extent that it still complies with the requirement of not being for a commercial purpose (see *infra*).

---

<sup>976</sup> *Ibidem*.

<sup>977</sup> Proposal for a Regulation of the European Parliament and of the Council implementing enhanced cooperation in the area of the creation of unitary patent protection, COM/2011/0215 final, see particularly art. 8.

<sup>978</sup> Frascati Manual 2002, *Proposed Standard Practice for Surveys on Research and Experimental Development*, OECD, 2002.

<sup>979</sup> M WALTER & S. VON LEWINSKI, *op. cit.*, n° 9.6.29.

<sup>980</sup> *ibidem*, n° 11.5.39,.

<sup>981</sup> E. DERCLAYE, *The legal protection of databases*, *op. cit.*, p. 132.

<sup>982</sup> E. DERCLAYE, “La transposition de la directive “droit d’auteur dans la société de l’information” au Royaume-Uni. Quelques aspects relatifs aux droits et aux exceptions”, *op. cit.*, p. 603, who refers to the *Consultation on UK Implementation of Directive 2001-1929/EC on Copyright and Related Rights in the Information Society : Analysis of Responses and Government Conclusions*, p. 6; P. TORREMANS, « De recente hervormingen in het auteursrecht in het Verenigd Koninkrijk », *A.M.*, 2006, p. 40.

<sup>983</sup> W. CORNISH, LLEWELYN & T. APLIN, *Intellectual Property: Patents, Copyright, Trade Marks and Allied Rights*, 7<sup>th</sup> ed., London, Sweet & Maxwell, 2010, p. 503, 12.39.

<sup>984</sup> See on that point for the Berne Convention, W. NORDERMANN, K. VINCK, P.W. HERTIN, *International Copyright and Neighbouring Rights Law*, WCH, Weinheim, 1990, p. 411.

Contrary to teaching purposes, the **requirement of 'illustration'** seems not to apply to scientific research<sup>985</sup>. This is sometimes considered as uncertain by commentators<sup>986</sup>, as the text might receive different interpretation depending of its language version. The English text (purpose of illustration for teaching or scientific research) grammatically indicates that illustration applies only to teaching, by want of the preposition 'for' before 'scientific research'. It is even more clearer in the German text that says: 'für die Nutzung ausschließlich zur Veranschaulichung im Unterricht oder für Zwecke der wissenschaftlichen Forschung', clearly separating the two purposes. On the other hand, the French ('à des fins exclusives d'illustration dans le cadre de l'enseignement ou de la recherche scientifique') or Italian ('finalità illustrativa per uso didattico o di ricerca scientifica') versions sound as relating illustration to both teaching and research. In French, in order to ascertain that illustration would not apply to research, it would have been better to formulate the exception as follows: à des fins exclusives d'illustration dans le cadre de l'enseignement ou de recherche scientifique, by deleting the preposition 'la'.

The notion of research refers to an activity and not to an institution organised for that purpose. As a result any person who carries on this kind of research may benefit from the exception: professors, researchers, students but also practising lawyers or medical doctors when they have to write articles, as well as private individuals to the extent they apply scientific methods to their research<sup>987</sup>.

The use of works has also to be justified by and limited to this purpose<sup>988</sup>. In other words, "the reproduction of articles on a topic that is not related to a given research topic and thus not necessary for carrying out that research would (...) not be justified by the purpose of research"<sup>989</sup>. The requirement of illustration is maybe not required for research, contrary to teaching, but the teleological approach that is implicit in the exception will limit the use of the work to what is needed to undertake the research.

## b) Beneficiaries

The exception for education and teaching does not determine its beneficiaries that can be any institution providing teaching or doing research<sup>990</sup>, as well as individual undertaking research. We have seen that the definition of teaching in the Berne Convention was limited to recognised educational institutions and would probably preclude adult education<sup>991</sup>, and therefore more informal organisms carrying out instruction and training from its scope. But this exclusion does not result of the definition of the beneficiaries of the exception. In its explanation of the requirement for the teaching and research to be non-commercial, the recital 42 considers that the organisational structure and the means of funding of the establishment concerned are irrelevant. Therefore both public and private educational and research institutions can benefit from the exception.

The Database Directive allows the Member States to exclude some teaching and research establishment from the benefit of the exception to the *sui generis* right, but such a rule is not contained in the 2001 directive.

## c) Works concerned

The directive does not limit in any way the categories of works that could be covered by the exception.

<sup>985</sup> M WALTER & S. VON LEWINSKI, *op. cit.*, n°11.5.48.

<sup>986</sup> E. DERCLAYE, *The legal protection of databases*, *op. cit.*, p. 137.

<sup>987</sup> M WALTER & S. VON LEWINSKI, *op. cit.*, n°11.5.48.

<sup>988</sup> S M WALTER & S. VON LEWINSKI, *op. cit.*, n° 11.5.39.

<sup>989</sup> *Ibidem*.

<sup>990</sup> M. IGLESIAS, *op. cit.*, p. 230.

<sup>991</sup> Adult education can be organised by schools and universities but could also be delivered by associations or organisations specialised in training or even by public organisms in charge of professional training for unemployed people.

What has been said for **unpublished works** for the library exception would equally apply here: the list of exceptions of the article 5 of the InfoSoc Directive does not say anything about published or unpublished works and no rule of exclusion of unpublished works from the benefit of copyright exceptions can be found in the *acquis communautaire*. The reverse rule is not explicit either.

That being said, the works that teachers will use to illustrate their teachings will generally be published or have been disclosed. That might not be always the case in research, where unpublished works can have a particular value in some fields (like history, art history, literature, ...) and could be the subject of scientific investigation. However, the restriction to the exception to the *sole* purpose of research could prevent the divulgation or publication of the work without the consent of the copyright owner.

It should be reminded that **databases** are subject to a similarly worded exception, at least for the copyright protecting the structure of the database. As to the *sui generis* right, the exception will be limited to acts of extraction of the database contents, but will not be valid for re-utilisation, which makes the exception rather useless (see *supra*).

No exception for education or research pertains to **computer programs**, the applicable directive being silent in that regard. Yet, in computer science, software could be used to illustrate teaching of their language, programming or operation, as well as for experimentation and research. Computer games could also serve for education in the field of graphic design. For video games contain both software elements and graphic elements, they will be protected both by the computer program directive and by the directive 2001/29. To that extent, video games could maybe benefit from the exception listed in the article 5 of the latter directive for purposes of teaching and research<sup>992</sup>. In addition, an exception for research might well not be needed for computer programs as they benefit from a specific exception "to study or test the functioning of the program in order to determine the ideas and principles which underlie any element of the program", which can cover most activities of research.

#### d) Authorised acts

Article 5(3) a) of the Directive 2001/29 allows Member States to adopt an exception to the reproduction right provided in Article 2 and to the rights of communication to the public of works and of making available to the public other subject-matter provided in Article 3. The exception can also cover acts of distribution through the application of article 5(4) of the Directive.

Recital 42 explicitly includes distance learning in the scope of the exception.

#### e) The limitation to non-commercial purpose

Only acts accomplished with a non-commercial purpose will benefit from the exception, as the end of the provision of article 5(3) a) requires that the use is contained "to the extent justified by the non-commercial purpose to be achieved". This condition applies both to teaching and research activities. Recital 42 of the directive further specifies that "when applying the exception or limitation for non-commercial educational and scientific research purposes, including distance learning, the non-commercial nature of the activity in question should be determined by that activity as such. The organisational structure and the means of funding of the establishment concerned are not the decisive factors in this respect". The registration to a curriculum at a school or university can require some fee or tuition without preventing the application of the exception. The purpose of the teaching or research activity itself will determine whether the non-commercial dimension is satisfied.

---

<sup>992</sup> See *supra* the development on the EU case law on a distributive application of the two directives to computer programs.

This can be understood in two different ways<sup>993</sup>. On one hand, the commercial nature can pertain to the act of use itself. For instance, copies of works to illustrate some teaching would be distributed to students for a fee exceeding its cost. Another interpretation would connect the commercial purpose to the activity of teaching or research. Under such interpretation, supported by recital 42, a professor of a non-for profit university will not be eligible for the exception when she provides commercial training or does research for a consultation commissioned and paid by a private company. Research undertaken by a pharmaceutical industry, as it aims at developing commercial products, or research done by a lawyer for the purpose of preparing a case for a client, will also run afoul of the exception requirements. The principle of strict interpretation applying to exceptions to copyright and related rights would favour a cumulative application of both interpretations.

The criterion of 'commercial' includes both direct and indirect commercial advantages<sup>994</sup>. Researches done by companies to make profits are not in the scope of the exception<sup>995</sup>. Same reasoning should apply to university spin-offs to the extent they purport to bring on the market products or to deliver licences based on the research carried out by universities. The further research carried out at the stage of the spin-off should probably be excluded from the scope of the exception, whereas the research done by the university upstream would be covered.

Some difficulty of application could arise in research for no scientific research is completely disinterested. Research can be done for non-commercial purposes and eventually generate some commercial products, the filing of a patent or result in the publication of a book that could elicit some revenue. It would be unreasonable to disqualify the research (involving use of protected works) that was not undertaken with a commercial motive for the sole reason that further to that research, some revenue or benefit has been extracted<sup>996</sup>. The nature of funding, whether private or public, should not be the sole criteria for determining whether a research is commercial or not. Research could be considered as non-commercial if the actual conducting of the research is not commercial, even when it is funded by commercial companies.

The provision that the use is limited "to the extent justified by the non-commercial purpose to be achieved" introduces some proportionality. It corresponds to the limitation to fair practices appearing in the exception of the Berne Convention. Both the scope of the use and the length of the portion of the work concerned would not pass muster if they exceed what is strictly necessary to illustrate teaching or to do research.

## **f) Other conditions**

### **(i) Indication of the source**

In addition, the source, including the author's name, has to be indicated. Similarly, Article 10(3) of the Berne Convention indicates that "mention shall be made of the source, and of the name of the author if it appears thereon". The source could refer to the title of the work, its publisher and not only to the author's name. This mention is mandatory unless "this turns out to be impossible". This refers to cases of legal impossibility when the author remains anonym or uses a pseudonym<sup>997</sup>. In other cases, "the directive

---

<sup>993</sup> M. IGLESIAS, *op. cit.*, p. 228-229.

<sup>994</sup> M WALTER & S. VON LEWINSKI, *op. cit.*, n° 11.5.39.

<sup>995</sup> E. DERCLAYE, "La transposition de la directive "droit d'auteur dans la société de l'information" au Royaume-Uni. Quelques aspects relatifs aux droits et aux exceptions", *op. cit.*, p. 603, who refers to the *Consultation on UK Implementation of Directive 2001/29/EC on Copyright and Related Rights in the Information Society : Analysis of Responses and Government Conclusions*, p.6.

<sup>996</sup> Contra, E. DERCLAYE, "Of Maps, Crown Copyright, Research and the Environment", *E.I.P.R.*, 2008, p.163 (giving the example of a researcher whose research is namely done to write a book).

<sup>997</sup> M WALTER & S. VON LEWINSKI, *op. cit.*, n° 11.5.39.

does not indicate what efforts must be made to find the author's name or other indication of source before such indication may be considered impossible"<sup>998</sup>. Some commentators have doubted that the cases where it would be impossible to cite the source of the work would be many, as the user would generally know where she has borrowed the work she uses to illustrate her teachings<sup>999</sup>. Nevertheless, in the hypothesis of unpublished works, supposing that the exception could apply thereto, the absence of the mention of the source could be accepted if it is impossible to identify the authors thanks to a reasonable investigation<sup>1000</sup>. Another interpretation would be that it could be impossible, in some cases, to mention the name of the author and the source of the work, when the work is used in a way that makes it difficult to mention the source and author's name.

### **(ii) Fair compensation**

Although the directive does not require that some remuneration is paid to the right holders, "the application of the three-step test (...) may result in an obligation of the Member States to provide for some form of fair compensation or remuneration"<sup>1001</sup>. In addition, Recital 36 leaves at the discretion of Member States to "provide for fair compensation for rightholders also when applying the optional provisions on exceptions or limitations which do not require such compensation". The education exception leads to compensation for rights holders in many Member States.

In one amendment to the draft directive, the European Parliament had proposed to make the exception subject to the payment of fair compensation. This was accepted by the Commission but the Council decided not to impose a compensation and referred instead to the newly introduced recital 36<sup>1002</sup>.

## **4. Other educational uses**

The question also arises to know whether certain teaching uses of works (public performances, recitations, course packs, anthologies, copies for exams...) are included in the scope of Article 5(3) a).

We have developed *supra* the opinion that the making of copies for exams<sup>1003</sup>, of course packs, public performances or recitations when carried out in the course of teaching as exercises or development of educational activities could be covered by a broad definition of illustration of teaching.

Concerning the making of anthologies, the answer is not so clear. Article 5(3) a) of the Infosoc directive seems to be flexible enough as to the extent and amount of use to consider that teaching anthologies are encompassed by the exception. As one scholar puts it, "in a digital teaching context it is very difficult to distinguish between material that is "used in the course of the instruction" and a "teaching anthology" [...] the all-encompassing EU solution makes sense"<sup>1004</sup>. Nevertheless, only teaching anthologies "that are used for teaching purposes and comply with the non-commercial requirement, as well as with the three-step test (...) will qualify"<sup>1005</sup>. Obviously, if the anthology is made by a specialized publisher, its use by a teacher during a lesson could not benefit from the exception because it will conflict with the normal exploitation of the work.

---

<sup>998</sup> *Ibidem*.

<sup>999</sup> *Ibidem*.

<sup>1000</sup> E. DERCLAYE, "La transposition de la directive ... », *op. cit.*, p. 6.

<sup>1001</sup> M WALTER & S. VON LEWINSKI, *op. cit.*, n° 11.5.39.

<sup>1002</sup> Communication of the European Commission on the Common position, 20.10.2000, SEC(2000) 1734 final, p. 7.

<sup>1003</sup> Contra, M WALTER & S. VON LEWINSKI, *op. cit.*, n° 11.5.39.

<sup>1004</sup> R. XALABARDER, *Study on Copyright Limitations and Exceptions for Educational Activities in North America, Europe, Caucasus, Central Asia and Israel*, *op. cit.*, p. 104.

<sup>1005</sup> R. XALABARDER, « On-line teaching and copyright : any hopes for an EU harmonized playground ? », *op. cit.*, n° 15, p. 384.



Anyway, if one decides that these acts are not covered by the current exception of Article 5(3) a), in any case, the exception of Article 5(3) o) could apply to some extent. It provides that “use in certain other cases of minor importance where exceptions or limitations already exist under national law, provided that they only concern analogue uses and do not affect the free circulation of goods and services within the Community, without prejudice to the other exceptions and limitations contained in this Article”. The limitation of the exception, also called the grand-father clause, to analogue uses would prohibit the making of digital anthologies or coursepacks, notably in e-learning environments. Another ground to allow the making of anthologies for students, if limited in scope, would be the minor reservations doctrine of the Berne Convention<sup>1006</sup>.

## 5. Implementation of the exception in the Member States

As well as for the exception for certain acts of reproduction made by libraries, the exception of the article 5(2) a) has been transposed in all the Member States that are analyzed by the study. But all the Member States have not transposed this provision in the same way, being also more detailed in the implementation, and sometimes more restrictive and narrower than the directive, with the result in some countries that distance or internet-based learning at home is not covered<sup>1007</sup>. The reason for these differences lies in the optional nature of the exception and the discretion the Member States have in the choice of the measures to transpose the Directive. As outlined in the Green Paper, “different treatment of the same act in different Member States may lead to legal uncertainty with regard to what is permitted under the exception, especially when teaching and research are carried out within a transnational framework”<sup>1008</sup>, whereas the objective was the harmonization of the legislations. Those differences will be discussed in the present section.

### a) Objectives

#### (i) *Illustration for teaching*

Some differences between Member States are reflected in the objectives pursued by the exception, more specifically as to **the condition of illustration for teaching or scientific research**. Some countries use the exact terms of the directive: it is the case for Belgium<sup>1009</sup>, France<sup>1010</sup> (where sectorial agreements set out in details what must be understood by ‘illustration’), Hungary<sup>1011</sup>, Italy<sup>1012</sup> (for use except for the publication on the internet with reference to ‘didactical use’), and finally Luxemburg<sup>1013</sup>. Some refers to illustration but solely in teaching, research being covered by another provision as in Germany<sup>1014</sup> (for illustration in teaching at schools), Spain<sup>1015</sup> (for the illustration of its educational activities in classrooms) and The Netherlands<sup>1016</sup> (illustration for teaching). Finally, the condition of illustration is sometimes missing in national copyright laws as in Poland<sup>1017</sup> (for teaching or research purposes), UK<sup>1018</sup> (‘in the

<sup>1006</sup> *Ibidem*, n° 15, p. 373.

<sup>1007</sup> *Green Paper on Copyright in the Knowledge Economy*, 16.7.2008, COM(2008) 466 final, p. 16

<sup>1008</sup> *Ibidem*, p. 17

<sup>1009</sup> Article 22, §1, 4bis°, 4ter° and 4quater° of the Belgian Law of 30 June 1994 related to Copyright and Neighbouring Rights.

<sup>1010</sup> Article L122-5, 3°, e) of the French Intellectual Property Code of 1 July 1992.

<sup>1011</sup> Article 34, §2

<sup>1012</sup> Article 70 of the Italian Law No. 633 of 22 April 1941 for the Protection of the Copyright and the Other Related Rights to its Exercise.

<sup>1013</sup> Article 10, 2° of the Luxemburg Law of 18 April 2001 on Copyrights, Neighbouring Rights and Databases.

<sup>1014</sup> Articles 53 and 53a of the German Act of 9 September 1965 on Copyright and Related Rights.

<sup>1015</sup> Article 32.2 of the Spanish Consolidated Text of 1 April 1996 on Intellectual Property,.

<sup>1016</sup> Article 16 of the Dutch Auteurswet of 23 September 1912.

<sup>1017</sup> Article 27 of the Polish Law No. 83 of 4 February 1994 on Copyright and Neighbouring Rights.

course of instruction or of preparation for instruction', with no foreseen change with the new version of the law under discussion, except that the new subsection (2) sets out what is meant by the term "instruction"<sup>1019</sup>), Italy<sup>1020</sup> (for 'didactic or scientific use' in the case of a publication on the internet), and Denmark<sup>1021</sup> (the provision refers to 'educational activities').

It is worth coming back more specifically to the case of France, where sectorial agreements complete the general provision about the exception in the Copyright Act. The protocol provides a definition of what is meant by the notion of 'illustration for teaching and research': "the use of a work or an extract from work only to clarify or support a discussion, development or argument forming the main subject of the course of teachers, teaching work of pupils and students or research work"<sup>1022</sup>.

The purpose of **examination** is also provided for in some countries: in France – development and dissemination of exam subjects<sup>1023</sup>, in the UK<sup>1024</sup> – anything done for the purposes of an examination, in Germany<sup>1025</sup>, in Hungary<sup>1026</sup>, and in Belgium<sup>1027</sup> – the free performance of a work during a public exam. In a Belgian analysis of the Copyright Law, the author points out that such use is included within the framework of school activities, and then of the article 5(3) a) of the Directive<sup>1028</sup>.

### **(ii) Scientific research**

The implementation of the exception generally follows the directive and combines in one provision the objectives of teaching and research without treating them differently. Accordingly, research is included in the education exception in Belgium<sup>1029</sup>, France<sup>1030</sup>, Hungary<sup>1031</sup>, Italy<sup>1032</sup>, Luxemburg<sup>1033</sup>, and Poland<sup>1034</sup>. Generally no specific conditions are defined for research that is subject to the requirements applicable for the teaching objective. Germany separates the purpose of research from the purpose of teaching in two distinct paragraphs but the differences between the two exceptions are minimal.<sup>1035</sup>

Some countries reserve a distinct treatment to uses for research purposes. For instance, Denmark allows the copies of works of art in scientific presentations<sup>1036</sup>. This rather restricts the use of copyrighted works for research purposes to one type of activities and one category of works and the limit with the quotation

<sup>1018</sup> Article 36 of the British Copyright, Designs and Patents Act of 15 November 1988.

<sup>1019</sup> See the website of the UK Intellectual Property Office.

<sup>1020</sup> Article 70.1*bis*.

<sup>1021</sup> Articles 13 and 21, (1) and (2) of the Danish Consolidated Act No. 202 of 27 February 2010 on Copyright.

<sup>1022</sup> Article 2.1 of the Protocole d'Accord Transitoire sur l'utilisation des livres, de la musique imprimée, des publications périodiques et des œuvres des arts visuels à des fins d'illustration des activités d'enseignement et de recherche.

<sup>1023</sup> Article L122-5, e) update 10 July 2013.

<sup>1024</sup> Section 32.

<sup>1025</sup> Article 53.3.

<sup>1026</sup> Article 35.5.

<sup>1027</sup> Article 22, §1, 7°.

<sup>1028</sup> M M.-Ch. JANSSENS, "Commentaar bij art. 21, 22, 22*bis* en 23*bis* Auteurswet", *op. cit.*, p. 151.

<sup>1029</sup> Article 22, §1, 4*bis*°, 4*ter*° and 4*quater*° of the Belgian Law of 30 June 1994 related to Copyright and Neighbouring Rights.

<sup>1030</sup> Article L122-5, 3°, e) of the French Intellectual Property Code of 1 July 1992.

<sup>1031</sup> Article 33, (4) of the Hungarian Act LXXVI of 22 June 1999 on Copyright.

<sup>1032</sup> Article 70 of the Italian Law No. 633 of 22 April 1941 for the Protection of the Copyright and the Other Related Rights to its Exercise.

<sup>1033</sup> Article 10, 2° of the Luxemburg Law of 18 April 2001 on Copyrights, Neighbouring Rights and Databases.

<sup>1034</sup> Article 27 of the Polish Law No. 83 of 4 February 1994 on Copyright and Neighbouring Rights.

<sup>1035</sup> Article 53a of the German Act of 9 September 1965 on Copyright and Related Rights.

<sup>1036</sup> Article 23 of the Danish Consolidated Act No. 202 of 27 February 2010 on Copyright.

exception seems rather thin<sup>1037</sup>. UK is another example of a clear separation between education and research<sup>1038</sup>. The Section 29 of the Copyright, Design and Patent Act admits fair dealing with a literary, dramatic, musical or artistic work for the purposes of research for a non-commercial purpose, whereas educational uses are exempted by another provisions, from section 32 to sections 36A. Notice that this provision, as well as the French provision, does not include the term “scientific” used in the Directive to qualify the research, as the British Government considered<sup>1039</sup> the insertion of this word as redundant<sup>1040</sup>.

Two countries amongst those analysed for the present study, do not know any exception for research purposes. They are Spain<sup>1041</sup> and the Netherlands<sup>1042</sup>.

Interestingly, case law has sometimes had to define the notion of research contained in the exception<sup>1043</sup>. A UK decision<sup>1044</sup> specified that in article 29, which has to be interpreted in the light of article 5(3) a of the directive InfoSoc, the purpose of research “must be narrowly interpreted as meaning ‘for the purposes of scientific research’”<sup>1045</sup>. As regards the condition of illustration required by the European provision, the court held that “it is not clear whether the exception must also be interpreted as being restricted to illustration for ... scientific research”, which led the judge to assume that the word “illustration” is linked to teaching but not to research<sup>1046</sup>. In the same case, the judge decided that the defendants did not reproduce the list of data for the purpose of scientific research but “for the forensic purpose of enabling themselves and others to extract data from mobile phones for use in criminal investigations”, which did not amount according to the decision, to scientific research<sup>1047</sup>. Another UK decision insists on the fact that the exception requires not only that the purpose of the act is for research but also that the purpose is a non-commercial one<sup>1048</sup>. The conditions are not alternative. We will come back to that decision.

A decision of the Danish Eastern Court of Appeal, in 2000, considered that an art book/journal published a couple of times a year by the art museum ‘Louisiana’ was not for scientific research<sup>1049</sup>. In another decision<sup>1050</sup>, the same court decided that a newspaper feature article and a newspaper review were not equivalent to scientific research.

---

<sup>1037</sup> The exception for quotation is referred to in the article 22 of the Danish Copyright Act with no specific purpose mentioned. The article for inclusion of works of art in scientific presentations just follows, which makes think that the two exception are close.

<sup>1038</sup> Article 29 of the British Copyright, Designs and Patents Act of 15 November 1988.

<sup>1039</sup> Consultation on UK Implementation of Directive 2001-1929/EC on Copyright and Related Rights in the Information Society: Analysis of Response and Government Conclusions, p. 6.

<sup>1040</sup> E. DERCLAYE, “La transposition de la directive ‘droit d’auteur dans la société de l’information’”, *op. cit.*, p.603.

<sup>1041</sup> Only provided for databases, see Article 34.

<sup>1042</sup> Except for the exception of article 15af the Dutch Auteurswet allowing for quotation in scientific writings, but this could be related to the quotation exception.

<sup>1043</sup> W. CORNISH ET AL, *op. cit.*, p. 503, 12.39.

<sup>1044</sup> *Forensic Telecommunications Services Ltd v Chief Constable of West Yorkshire Police*, High Court of Justice, Chancery Division, 9 November 2011, [2011] EWHC 2892 (Ch), [2012] F.S.R. 15.

<sup>1045</sup> *ibidem*, §109.

<sup>1046</sup> *ibidem*.

<sup>1047</sup> *ibidem*.

<sup>1048</sup> *The Controller of Her Majesty’s Stationery Office, Ordnance Survey v Green Amps Limited*, Case No: HC07C00249, High Court of Justice, Chancery Division Intellectual Property, 5 November 2007, [2007] EWHC 2755 (Ch), §21 (see the comment of the decision by E. Derclaye, “Of Maps, Crown Copyright, Research and the Environment”, *E.I.P.R.*, 2008, p.162. See also T. APLIN, “United Kingdom”, in B. LINDNER and T. SHAPIRO (eds.), *Copyright in the information society: a guide to national implementation of the European Directive*, Cheltenham, Edward Elgar, 2011, p. 572.

<sup>1049</sup> Ugeskrift for Retsvaesen 2000.1291Ø.

<sup>1050</sup> Eastern Court of Appeal, 17 May 2002 ; this is an unreported case mentioned by Thomas Riis (national expert for Danish legislation).

## b) Beneficiaries and users

The Directive does not reserve the application of the exception to specific **beneficiaries**. Sometimes, Member States have stated that the benefit of the exception concerns also educational or research establishments, or else particular individuals. Some domestic laws have even been very specific as to who may or may not rely on the exception. On the contrary, others followed the wording of the Directive. This lack of determined beneficiaries in the drafting of first, the Directive, and then in the national transposition laws, can be understood as an attempt to apply the exception to all educational institutions, which is confirmed by the text of recital 42 of the Directive, the latter referring to the notion of *establishments concerned*. Recital 34 speaks about *public institutions*, which is consistent with the requirement of realization of uses for a non-commercial purpose.

First, States **that have not included in their domestic law a specific beneficiary** include Denmark, Italy, Luxemburg, the UK (only for the act of *fair dealing* with a work for the purpose of research and the reproduction for purposes of instruction and examination) and the Netherlands.

Belgium limits the making available through the closed networks of the concerned institutions to 'the establishments recognised or officially organised for that purpose by the public authorities'. Whereas the general exception for teaching in the French Intellectual Property Code do not specify its beneficiaries, sectoral agreements further defines the covered educational institutions, which are only those governed by the Ministers that have signed the agreements. As a consequence, some educational institutions belonging to the competence of Ministers of Culture or Agriculture are not covered by the agreements and in practice will not enjoy the possibilities of the general exception.

Others Member States restrict the benefit of the exception to educational establishments or teaching profession: in Denmark, beneficiaries are teachers and students for the act of reproduction within educational activities, in Spain<sup>1051</sup>, teachers of regulated education. In Poland, the exception applies to research and educational institutions<sup>1052</sup>. In the Hungarian law, a specific disposition enumerates the concerned establishments<sup>1053</sup>, but solely for teaching purposes, not for scientific research, as well as in Germany<sup>1054</sup>. Finally, in the UK for all acts other than reprographic reproduction and fair dealing in research, the beneficiaries are the educational establishments<sup>1055</sup>. The Section 174 of the UK Copyright Law gives a definition of what is meant by educational establishments.

Some Member States also define the **users** that would ultimately benefit from the exception. For instance, in the UK, the **users** include a person giving or receiving instruction in the case of reproduction (other than reprographic)<sup>1056</sup>; a teacher or pupil or by any person for the purposes of instruction in the case of performing, playing or showing a work<sup>1057</sup>; the communication to the public by a person situated within the premises of an educational establishment of a recording of a broadcast or a copy of such a recording<sup>1058</sup>.

---

<sup>1051</sup> Article 32 of the Spanish Consolidated Text of 1 April 1996 on Intellectual Property, *op. cit.*, p. 14369.

<sup>1052</sup> Article 27 of the Polish Law No. 83 of 4 February 1994 on Copyright and Neighbouring Rights, *op. cit.*, p. 301.

<sup>1053</sup> Schools, universities, non-commercial institutions of education and further education, and at vocational training institutions for the act of making works available to the public for instruction and research but the universities are missing in the provision providing the act of reproduction and are replaced by higher education institutions.

<sup>1054</sup> Article 52a and 53 of the German Act of 9 September 1965 on Copyright and Related Rights.

<sup>1055</sup> Sections 34-36 of the Copyright Act.

<sup>1056</sup> Section 32.

<sup>1057</sup> Section 34.

<sup>1058</sup> Section 35.

### c) Works concerned

The scope of the national implementation of Article 5(3) a) of the Directive is sometimes also limited to a determined **subject matter** and a limited **quantity** of the works used in the teaching.

#### (i) Type of works covered

For instance, the exception applies only to articles or works of fine art in part or in whole or short fragments of other works in Belgium<sup>1059</sup>; works of art and works of a descriptive nature for the use in scientific presentation in Denmark<sup>1060</sup>; extracts of works in France<sup>1061</sup>, but sectoral agreements have so far concerned only books, printed music, periodical publications and works of visual arts; small or limited parts of a work, small scale works, as well as individual articles from newspapers or periodicals in Germany<sup>1062</sup>; parts of a literary, musical work or film made public, or such entire works of a smaller extent as well as pictures of works of fine art, architectural, applied art and industrial design creations as well as photographic works and specific parts of published books, newspaper and periodical articles in Hungary<sup>1063</sup>; fragments or parts of works in Italy<sup>1064</sup>; low resolution or degraded images and music also in Italy<sup>1065</sup>, in the case of publication on the internet; short fragments of works in Luxemburg<sup>1066</sup>; parts of literary, scientific or artistic work or the entire work of short drawings, paintings, works of architecture and sculpture, lithographs, engravings and the like, photographic works, works of applied art and industrial designs and models in The Netherlands<sup>1067</sup>; fragments of disseminated works in original and in translation in case of making copies in Poland<sup>1068</sup>; small fragments of works or isolated works of plastic or photographic figurative character in Spain<sup>1069</sup>; and finally, in the case of research<sup>1070</sup>, to literary, dramatic, musical or artistic work or, in the case of instruction<sup>1071</sup>, to extracts of published literary, dramatic or musical works or published editions as well as to a sound recording, a film or a broadcast in the UK. In Germany<sup>1072</sup>, copies in graphic data file are permitted in quantities required for the person receiving instruction. Concerning the provision 52a UrhG, the Court of Appeal of Stuttgart of the 4 April 2012 has held that an extract of 91 pages of a psychology textbook made available to students by a teacher on an electronic platform is not a “small part” of the textbook<sup>1073</sup>. This condition must be assessed *in casu*, from a quantitative point of view and in relation to the work as a whole and its content<sup>1074</sup>. The Court sets a limit of 3 pages beyond which the exception can no longer be claimed, for purposes of legal certainty.

This long enumeration reveals that Member States tend to limit the use to extracts of works.

---

<sup>1059</sup> Article 22, §1, *4bis*° and *4ter*° of the Belgian Law of 30 June 1994 related to Copyright and Neighbouring Rights. A royal decree is expected to give a new formulation of Article 22, §1, *4bis*° including work of graphic art.

<sup>1060</sup> Article 23 of the Danish Consolidated Act No. 202 of 27 February 2010 on Copyright.

<sup>1061</sup> Article L122-5, 3°, e) of the French Intellectual Property Code of 1 July 1992.

<sup>1062</sup> Article 52a and 53 of the German Act of 9 September 1965 on Copyright and Related Rights.

<sup>1063</sup> Articles 34 (2) and 35 (5) of the Hungarian Act LXXVI of 22 June 1999 on Copyright.

<sup>1064</sup> Article 70 of the Italian Law No. 633 of 22 April 1941 for the Protection of the Copyright and the Other Related Rights to its Exercise.

<sup>1065</sup> *ibidem*.

<sup>1066</sup> Article 10, 2° of the Luxemburg Law of 18 April 2001 on Copyrights, Neighbouring Rights and Databases.

<sup>1067</sup> Article 16 of the Dutch Law of 23 September 1912 containing New Regulation of Copyright.

<sup>1068</sup> Article 27 of the Polish Law No. 83 of 4 February 1994 on Copyright and Neighbouring Rights.

<sup>1069</sup> Article 32 of the Spanish Consolidated Text of 1 April 1996 on Intellectual Property.

<sup>1070</sup> Article 29 of the British Copyright, Designs and Patents Act of 15 November 1988.

<sup>1071</sup> Articles 32 to 36 of the British Copyright, Designs and Patents Act of 15 November 1988.

<sup>1072</sup> Article 53 of the German Act of 9 September 1965 on Copyright and Related Rights.

<sup>1073</sup> OLG Stuttgart, 04.04.2012, 4 U 171/11, GRUR 2012, 718.

<sup>1074</sup> *Propriété Intellectuelle*, octobre 2012, n° 45, p. 487.

Contrariwise, the exception **does not apply to** works made for educational purposes in France<sup>1075</sup> and, only in case of making available to the public of these works and reproduction for such making available, in Germany<sup>1076</sup>. Besides university manuals, Spain also excludes textbooks. The justification of the exclusion of such works can be explained by the need to preserve their market for exploitation that is primarily constituted by educational establishments and teachers.

In addition, music scores are out of the scope of the exception in France<sup>1077</sup> and in Germany “audiovisual works can only be used (reproduced and made available online) for teaching purposes after two years upon release”<sup>1078</sup>.

In the UK, the provisions 35 and 36 apply only to the extent that licenses are unavailable for the activities covered. Schools and universities need to hold licenses for uses of copyright materials such as photocopying books, or recording television programs, and that does not change with the project to amend those articles.

### **(ii) Quantity**

In Hungary, the reproduction of specific parts of a work must be done in a **number** corresponding to the number of students in class or in a number necessary for the exams. **The format** can also be determined: in Italy, the publication on the Internet of images and music is permitted only if they are degraded or in low resolution.

Some limitation on the quantity of admitted copies can also result from the accommodation of the exception with **fair practice**, one criterion that can be found in the article 5(3) a) of the directive. For instance, the Netherlands<sup>1079</sup> requires that the provision be applied in accordance with ‘what might reasonably be accepted under the social rules’ whereas Denmark<sup>1080</sup> speaks about ‘proper usage’, Belgium about ‘the extent justified by the purpose’ and Luxemburg about ‘fair practice’. The notion of *fair dealing* that gives an overall frame to the exception for teaching and research in the UK<sup>1081</sup> is not defined in the Copyright Act, but was developed progressively by the judges by their decisions that provide that some factors help to determine whether a use is fair<sup>1082</sup>.

## **d) Authorized acts**

### **(i) Exclusive rights exempted by the exception**

All authorized acts do not apply to all works covered by the exception for teaching in the domestic laws for there are large variations among Member States.

The act authorized by the directive is included under the general term of "use". Article 5(3) of the Directive expressly refers to Articles 3 and 4, which deal respectively with the reproduction and communication to the public. In addition, article 5(4) states that when the Member States may provide for an exception or limitation to the reproduction right under paragraph 3, they may also provide for an exception or limitation

<sup>1075</sup> Article L122-5, 3°, e) of the French Intellectual Property Code of 1 July 1992.

<sup>1076</sup> Article 52a of the German Act of 9 September 1965 on Copyright and Related Rights, *op. cit.*, p. 1273.

<sup>1077</sup> Article L122-5, 3°, e) of the French Intellectual Property Code of 1 July 1992, *op. cit.*

<sup>1078</sup> R. XALABARDER, *Study on Copyright Limitations*, *op. cit.*, p. 89.

<sup>1079</sup> Article 16 of the Dutch Law of 23 September 1912 containing New Regulation of Copyright.

<sup>1080</sup> Article 23 of the Danish Consolidated Act No. 202 of 27 February 2010 on Copyright.

<sup>1081</sup> Article 29 of the British Copyright, Designs and Patents Act of 15 November 1988.

<sup>1082</sup> E. DERCLAYE, « La transposition de la directive ‘droit d’auteur dans la société de l’information’ ... », *op. cit.*, p.602.

to the right of distribution covered by article 4, to the extent justified by the purpose of the authorized act of reproduction.

Some countries – like Poland – have literally taken the very general term of **use** for the sole purpose of illustration for teaching or scientific research of the directive to exempt uses for educational purposes. Such use may be interpreted as exempting any type of acts of exploitation, therefore including making available online and digitization. In majority though, the other Member States having decided to specify the authorized acts. First of all, **reproduction** is encompassed in all the national provisions, to a greater or lesser extent. Most of the time, this act of reproduction permits the digital reproduction, explicitly or not. For instance, in Belgium, the law draws a distinction between the reproduction on paper or any similar medium and the reproduction in any medium other than paper or similar medium, the latter aiming clearly at the reproductions under a digital format.

**Communication** is referred to in Belgium<sup>1083</sup>, France<sup>1084</sup>, Luxemburg<sup>1085</sup>, Italy<sup>1086</sup> and Spain<sup>1087</sup>, along with publication in the Netherlands<sup>1088</sup> and in Italy<sup>1089</sup>, making available to the public and transmission in Germany<sup>1090</sup>, borrowing in Hungary<sup>1091</sup>, summary and quotation as well as publication on the internet in Italy<sup>1092</sup>, use in Poland<sup>1093</sup>, distribution in Spain<sup>1094</sup>. In the proposal to amend the English law<sup>1095</sup>, the new version of the section 32 would cover the act of fair dealing for the purpose of instruction to allow “teachers to make reasonable use of copyright materials without infringing copyright”.

Some domestic laws also mention **translation** : for instance, in Poland<sup>1096</sup> and in the Netherlands – the reproduction in another language<sup>1097</sup>.

### **(ii) The application to e-learning**

The national laws do not always clearly deal with **e-learning**, even if Recital 42 of the Directive explicitly includes distance learning in the scope of the exception.

For instance, e-learning is seriously compromised in Hungary and in Spain, where face-to-face teaching seems to be the only situation to which the exception applies<sup>1098</sup>. The Spanish exception<sup>1099</sup> is limited to

<sup>1083</sup> Article 22, §1, 4<sup>quater</sup> of the Belgian Law of 30 June 1994 related to Copyright and Neighbouring Rights.

<sup>1084</sup> Article L122-5, 3°, e) of the French Intellectual Property Code of 1 July 1992.

<sup>1085</sup> Article 10, 2° of the Luxemburg Law of 18 April 2001 on Copyrights, Neighbouring Rights and Databases.

<sup>1086</sup> Article 70 of the Italian Law No. 633 of 22 April 1941 for the Protection of the Copyright and the Other Related Rights to its Exercise.

<sup>1087</sup> Article 32 of the Spanish Consolidated Text of 1 April 1996 on Intellectual Property.

<sup>1088</sup> Article 16 of the Dutch Law of 23 September 1912 containing New Regulation of Copyright.

<sup>1089</sup> Article 70 of the Italian Law No. 633 of 22 April 1941 for the Protection of the Copyright and the Other Related Rights to its Exercise.

<sup>1090</sup> Article 52a and 53 of the German Act of 9 September 1965 on Copyright and Related Rights.

<sup>1091</sup> Article 33, (4) of the Hungarian Act LXXVI of 22 June 1999 on Copyright.

<sup>1092</sup> Article 70 of the Italian Law No. 633 of 22 April 1941 for the Protection of the Copyright and the Other Related Rights to its Exercise.

<sup>1093</sup> Article 27 of the Polish Law No. 83 of 4 February 1994 on Copyright and Neighbouring Rights.

<sup>1094</sup> Article 32 of the Spanish Consolidated Text of 1 April 1996 on Intellectual Property.

<sup>1095</sup> *Technical review of draft legislation on copyright exceptions*, June 2013, <http://www.ipso.gov.uk/types/hargreaves/hargreaves-copyright/hargreaves-copyright-techreview.htm>.

<sup>1096</sup> Article 27

<sup>1097</sup> Article 16.4

<sup>1098</sup> this is also the case in Greece and Slovenia, see G. WESTKAMP, *op. cit.*

<sup>1099</sup> Article 32 of the Spanish Consolidated Text of 1 April 1996 on Intellectual Property.

the classrooms where the educational activities take place. The UK goes a little bit further by allowing the communication by an intranet, and not an extranet, which led The Gowers Review of Intellectual Property to say that “the exception does not extend to situations where students are not on the premises of the educational establishment. That means that distance learners are at a disadvantage compared with those based on campus”<sup>1100</sup>.

A counterexample is Belgium that, in the article 22, 4<sup>o</sup> *quarter* of the Copyright Act, adapts the exception for teaching to distance learning through the Internet. Despite the restriction of the communication “solely by means of closed transmission networks of the establishment”, the exception allows the transmission by an extranet network, as is clear from the parliamentary discussions, the goal being the limitation of the communication to a limited circle of identified persons, composed of teachers, students or researchers<sup>1101</sup>. In Germany, the article 52a aims at promoting the use of new technologies in education and research, including the e-learning development. It permits the making available online of “published small, limited parts of a work, small scale works, as well as individual articles from newspapers or periodicals” for the benefit of “the specifically limited circle of those taking part in the instruction”.<sup>1102</sup> In its previously mentioned decision, the Court of Appeal of Stuttgart held that the condition of a making available to a “specifically limited circle” of students is met when access to the teaching platform is controlled, regardless of the large number of holders of a password<sup>1103</sup>. In its new version of the exception, the e-learning is covered by the insertion of the sentence “particularly by means of a digital workspace”<sup>1104</sup>. The general wording of the Luxemburg and Polish provision suggests that e-learning can equally occur in those countries under the educational copyright exception.

More restrictive are the situations of Italy and Denmark. Italy<sup>1105</sup> admits the publication on the internet, but in a very limited way, for the publication should be of low resolution or degraded images and music<sup>1106</sup>. This publication must be done for didactic or scientific uses, but the decree that has to delimit the scope of such uses does not exist yet<sup>1107</sup>. In Denmark, teachers and pupils are allowed to record their own performances of works on the condition that they are only used for educational purposes<sup>1108</sup>. As noticed by R. Xalabarder, “it is not clear whether these performances could be transmitted beyond the premises of the educational establishment”<sup>1109</sup>.

When allowing for the exception in the frame of e-learning, the conditions applicable are generally determined so as to prevent dissemination of teaching material outside of the students enrolled in the course. For instance, Belgium requires that the communication intended for illustration of the teaching or the scientific research to take place by means of closed transmission networks of the establishment and within the scope of the normal activities of the establishment. The French exception speaks about ‘digital workspace’, and the sectorial agreement lists specific places where the acts can take place such as the representation in classroom, making available online on the establishment intranet and extranet. In Italy, the provision specifies that the publication is done “on the internet”<sup>1110</sup>. In the UK, the act covered cannot

<sup>1100</sup> A. Gowers, *Gowers Review of Intellectual Property*, Crown, December 2006, [www.hm-treasury.gov.uk/gowers/](http://www.hm-treasury.gov.uk/gowers/), p. 47, point 4.17.

<sup>1101</sup> *Doc. Parl.*, Chambre, sess. 2003-2004, n° 1137/008, p. 15.

<sup>1102</sup> A. LUCAS-SCHLOETTER, “Lettre d’Allemagne. Qu’y a-t-il dans la “deuxième corbeille” ? La loi allemande du 26 octobre 2007 relative au droit d’auteur dans la société de l’information”, *Propr. intell.*, 2008, n° 28, p. 370.

<sup>1103</sup> OLG Stuttgart, 04.04.2012, 4 U 171/11, GRUR 2012, 718.

<sup>1104</sup> Article L122-5, e) CPI

<sup>1105</sup> Article 70 of the Italian Law No. 633 of 22 April 1941 for the Protection of the Copyright and the Other Related Rights to its Exercise.

<sup>1106</sup> Article 70, §1bis.

<sup>1107</sup> G. MAZZIOTTI, *Copyright and Educational Uses: the Unbearable Case of Italian Law from a European and Comparative Perspective*, *op. cit.*, p. 11, available at [http://cadmus.eui.eu/bitstream/handle/1814/19697/LAW\\_2011\\_17\\_Mazziotti.pdf](http://cadmus.eui.eu/bitstream/handle/1814/19697/LAW_2011_17_Mazziotti.pdf)

<sup>1108</sup> Article 13.

<sup>1109</sup> R. XALABARDER, *Study on Copyright Limitations and Exceptions for Educational Activities*, *op. cit.*, p. 82.

<sup>1110</sup> Article 70, §1bis



take place outside the premises of the educational establishment<sup>1111</sup>. The new version of the law which is being discussed at the moment provides that, for sections 35 and 36, covering respectively the act of recording of broadcasts and the act of reprographic copying (that will change into copying and use of extract of works), the uses may “take place both on the premises of an educational establishment and via a secure distance learning networks”<sup>1112</sup>. The copyright material may not be “transmitted to persons unaffiliated with the educational establishment”.

### e) Other conditions

In compliance with Article 5(3) a) of the Directive, the **non-commercial nature** of the purpose pursued is implemented in Belgium<sup>1113</sup>, Denmark<sup>1114</sup>, France<sup>1115</sup>, Germany<sup>1116</sup>, Hungary<sup>1117</sup>, Italy<sup>1118</sup>, Spain<sup>1119</sup>, the Netherlands<sup>1120</sup>, and United Kingdom<sup>1121</sup>, but not in Luxembourg and Poland<sup>1122</sup>.

A UK decision stresses that the fact an establishment is publicly funded “is not determinative of whether the use was a non-commercial purpose”<sup>1123</sup>. In that specific case, the judge considered that the purpose of law enforcement (for use in criminal investigations) was not a non-commercial purpose<sup>1124</sup>. Moreover, according to the judge, the wording of the European provision related to “the extent justified by the non-commercial purpose to be achieved” has to be understood as the British notion of fair dealing<sup>1125</sup>. To appreciate the notion of fair dealing, the judge refers to three most important factors laid down in the decision *Ashdown v Telegraph Group Ltd*<sup>1126</sup>: “(1) the degree to which the alleged infringing use competes with exploitation of the copyright work by the owner (...); (2) whether the work has been published or not....; (3) the extent of the use and the importance of what has been taken (...)”<sup>1127</sup>. In the decision mentioned, the defendants’ reproduction of the list of data competed with the exploitation of works by the owner, the list was unpublished and the extent of the reproduction was considerable, three factors that weighted against of fair dealing<sup>1128</sup>. In addition, another UK decision specifies the moment when the commercial or non-commercial nature of the research has to be taken into account:

---

<sup>1111</sup> Sections 33, 34 and 35 CDPA.

<sup>1112</sup> Technical review of draft legislation on copyright exceptions, June 2013, <http://www.ipo.gov.uk/types/hargreaves/hargreaves-copyright/hargreaves-copyright-techreview.htm>.

<sup>1113</sup> Article 22, §1, 4bis°, 4ter° and 4quater° of the Belgian Law of 30 June 1994 related to Copyright and Neighbouring Rights.

<sup>1114</sup> Article 23 of the Danish Consolidated Act No. 202 of 27 February 2010 on Copyright.

<sup>1115</sup> Article L122-5, 3°, e) of the French Intellectual Property Code of 1 July 1992.

<sup>1116</sup> Articles 52a, 53 and 53a of the German Act of 9 September 1965 on Copyright and Related Rights.

<sup>1117</sup> Article 33, (4) of the Hungarian Act LXXVI of 22 June 1999 on Copyright.

<sup>1118</sup> Article 70 of the Italian Law No. 633 of 22 April 1941 for the Protection of the Copyright and the Other Related Rights to its Exercise.

<sup>1119</sup> Article 32 of the Spanish Consolidated Text of 1 April 1996 on Intellectual Property.

<sup>1120</sup> Article 16 of the Dutch Law of 23 September 1912 containing New Regulation of Copyright.

<sup>1121</sup> Article 29 and 36 of the British Copyright, Designs and Patents Act of 15 November 1988.

<sup>1122</sup> Article 27 of the Polish Law No. 83 of 4 February 1994 on Copyright and Neighboring Rights.

<sup>1123</sup> *Forensic Telecommunications Services Ltd v Chief Constable of West Yorkshire Police*, High Court of Justice, Chancery Division, 9 November 2011, [2011] EWHC 2892 (Ch), [2012] F.S.R. 15, §110.

<sup>1124</sup> *ibidem*.

<sup>1125</sup> *ibidem*.

<sup>1126</sup> *Ashdown v Telegraph Group Ltd* [2001] EWCA Civ 1142; [2002] Ch. 149.

<sup>1127</sup> *Forensic Telecommunications Services*, *op. cit.*, §111.

<sup>1128</sup> *ibidem.*, §112.

“Presumably, any research which, at the time it is conducted, contemplated or intended, should be ultimately used for a purpose which has some commercial value will not be within the permitted act”<sup>1129</sup>.

**Acknowledgment** i.e. the indication of the source including the author’s name, is sometimes mentioned in the legal provision itself, which transposes the exception, but also sometimes provided for in a separate article, like in Denmark. It is not required in Poland and, in the case of publication by Internet of low resolution or degraded images and music, in Italy, but well in Belgium<sup>1130</sup>, France, Germany<sup>1131</sup> the Netherlands<sup>1132</sup>, Luxemburg<sup>1133</sup>, Hungary<sup>1134</sup>, Italy<sup>1135</sup>, Spain<sup>1136</sup> and in the UK<sup>1137</sup>, the latter requiring a sufficient acknowledgement<sup>1138</sup> – most of those countries providing for this indication “except when this is impossible”.

The Directive does not provide any **compensation or remuneration** for the educational exception, but allows it under recital 34. Luxemburg, Hungary for the act of borrowing, and Germany for the act of reproduction, do not provide for any remuneration. The Belgian copyright law requires that some **remuneration** be paid to authors and publishers of works, based on a system of statutory licences<sup>1139</sup> whereas France<sup>1140</sup> requires compensation with negotiated remuneration on a flat-rate basis, the sectorial agreement fixing the amount of the remuneration.

Equitable remuneration is required in Germany (statutory licence)<sup>1141</sup> as in Italy for anthologies and fair payment in the Netherlands<sup>1142</sup> where it is specified that the latter is for the author or his rightholders. In Denmark, a system of extend collective licence is implemented<sup>1143</sup>, and is applicable to the act of reproduction within educational activities<sup>1144</sup>. In the UK, in the case of recording of broadcasts by educational establishments, the section “does not apply if or to the extent that there is a licensing scheme certified for the purposes of (the) section under section 143 providing for the grant of licenses”<sup>1145</sup>

In France<sup>1146</sup>, the **recipients** of the educational use are defined as the public to whom the performance or the reproduction is intended and made up of directly concerned pupils, students, teachers and researchers. In Germany<sup>1147</sup>, the recipients are limited to the specifically limited circle of those taking part in the teaching. In UK, the performance and the playing or showing of a work in the course of activities of

<sup>1129</sup> *The Controller of Her Majesty’s Stationery Office, Ordnance Survey v Green Amps Limited*, Case No: HC07C00249, High Court of Justice, Chancery Division Intellectual Property, 5 November 2007, [2007] EWHC 2755 (Ch), §23. The decision refers to Copinger, § 9-28.

<sup>1130</sup> Article 22, §1, *4bis*<sup>o</sup>, *4ter*<sup>o</sup> and *4quater*<sup>o</sup> of the Belgian Law of 30 June 1994 related to Copyright and Neighbouring Rights.

<sup>1131</sup> Article 63, §2.

<sup>1132</sup> Article 16 of the Dutch Law of 23 September 1912 containing New Regulation of Copyright.

<sup>1133</sup> Article 10, 2<sup>o</sup> of the Luxemburg Law of 18 April 2001 on Copyrights, Neighbouring Rights and Databases.

<sup>1134</sup> Article 33, (4) of the Hungarian Act LXXVI of 22 June 1999 on Copyright.

<sup>1135</sup> Article 70 of the Italian Law No. 633 of 22 April 1941 for the Protection of the Copyright and the Other Related Rights to its Exercise.

<sup>1136</sup> Article 32 of the Spanish Consolidated Text of 1 April 1996 on Intellectual Property.

<sup>1137</sup> Article 36 of the British Copyright, Designs and Patents Act of 15 November 1988.

<sup>1138</sup> Definition in Section 178.

<sup>1139</sup> Article 59 and 61 *bis* of the Belgian Law of 30 June 1994 related to Copyright and Neighbouring Rights.

<sup>1140</sup> Article L122-5, 3<sup>o</sup>, e) of the French Intellectual Property Code of 1 July 1992.

<sup>1141</sup> Article 52a and 53a of the German Act of 9 September 1965 on Copyright and Related Rights.

<sup>1142</sup> Article 16 of the Dutch Law of 23 September 1912 containing New Regulation of Copyright.

<sup>1143</sup> Article 50

<sup>1144</sup> Article 13.

<sup>1145</sup> Section 35 CDPA.

<sup>1146</sup> Article L122-5, 3<sup>o</sup>, e) of the French Intellectual Property Code of 1 July 1992.

<sup>1147</sup> Article 52a of the German Act of 9 September 1965 on Copyright and Related Rights.

an educational establishment must take place before an audience consisting of teachers and pupils and other persons directly connected with the activities of the educational establishment, excluding the parents of pupils<sup>1148</sup>.

#### f) Other exceptions for educational purpose

Most countries add other exceptions benefiting educational purposes to the general provision on illustration of teaching, for example for the making of anthologies or for acts of uses taking place during exams or school events.

Several countries have provided a specific exception for the making of **teaching anthologies**: it is the case for Belgium<sup>1149</sup>, Denmark, Germany<sup>1150</sup>, Italy<sup>1151</sup>, The Netherlands<sup>1152</sup>, Poland<sup>1153</sup> and UK<sup>1154</sup>.

Finally, there are provisions about use of works during **school events** in Belgium, Poland, Denmark<sup>1155</sup>, Hungary<sup>1156</sup> and Germany<sup>1157</sup>.

### 6. Overview of existing licensing mechanisms or collective agreements between stakeholders

The exception for teaching purposes is put into practice or is completed by collective agreements or particular licensing mechanisms. In such cases, uses of works and other subject matter for teaching or research are therefore not strictly covered by an exception to copyright and related rights but pertain to other mechanisms.

France is an example of an exception for teaching organized by the *Code de la Propriété Intellectuelle*, whose practical organization is governed by an intricate system of collective and by-sectors agreements<sup>1158</sup>. So far, two agreements<sup>1159</sup>, one for written publications and visual arts and the other for musical and audiovisual works, define the conditions of application of the exception and extend the scope of the exception as delineated by the law<sup>1160</sup>. This extension by collective agreements has several consequences. First, teachers and educational institutions need to understand the articulation of the legal exception and of what has been further authorized for the sector concerned. Second, the agreements determine the remuneration to be paid in compensation of the authorized use to the effect that the exception will not be applied if no remuneration is organized by the agreements, either because the

<sup>1148</sup> Section 34.

<sup>1149</sup> Article 21, §2 LDA – This provision permits the making of teaching anthologies only after the author's death (otherwise his consent is required)

<sup>1150</sup> Article 46.1

<sup>1151</sup> Article 70, §2.

<sup>1152</sup> Article 16.3

<sup>1153</sup> Article 29.2

<sup>1154</sup> Section 33

<sup>1155</sup> Article 21.

<sup>1156</sup> Article 38

<sup>1157</sup> Article 52.1 of the Copyright Act of 9 September 1965

<sup>1158</sup> *Protocole d'accord* of 1er February 2012 concerning the use of books, printed music, periodical publications and visual arts works for the purpose of illustrating educational activities and research activities" (BOEN n° 16 of 19 April 2012) and the Agreement on live performance of musical works, use of audio recordings of musical works and use of videomusics for the purpose of illustrating educational activities and research (BOEN n° 5 of 4 February 2010)

<sup>1159</sup> *ibidem*.

<sup>1160</sup> For the scope of the authorised uses due to the conjunction of the legal exception and those agreements, see the analysis of the French law in the section on the implementation of the education exception in national laws.

educational establishment is not covered<sup>1161</sup>, or because the work that the teacher wants to use is not part of the repertoire administered by the CMOs that have signed the agreement<sup>1162</sup>. That creates an exception à *géométrie variable* depending on sectorial and limited-in-time agreements. In practice, the teacher needs to check the inclusion of the work she wants to use in the agreement and educational establishments need to report the works that have been used to the collective organisation managing the right to remuneration (i.e. the Centre Français pour le Droit d'Exploitation de la Copie or CFC). The recent Report commissioned by the French Minister of Culture to Pierre Lescure has criticised the complexity of such agreements and the time-consuming administrative burden and legal insecurity they engender<sup>1163</sup>.

As the teaching exception in Spain does not allow for online teaching, the Centro Español de Derechos Reprográficos (CEDRO), i.e. the CMO active in reprography rights of authors and publishers, grants a license to universities and teaching institutions for the reproduction and making available (including online) of copyrighted works for teaching purposes – for a fee of 5 euros per student<sup>1164</sup>. The license is based on voluntary mandate of rights from authors and publishers to CEDRO. Such licensing, based on voluntary collective management, does not cover all members of CEDRO, some of them being reluctant to grant online rights to the collective society, and certainly not all authors or publishers.

Other examples of collective mechanisms is the extended collective licensing that exists in Scandinavian countries (e.g. Sweden, Finland and Denmark) and constitute the ground, on the basis of the exclusive rights given to collective management, to authorize educational and research uses.

Therefore, as far as uses for illustration for teaching and research are concerned, the recourse to collective mechanisms follows different models:

- they put the exception into practice and organise the remuneration associated thereto (French model)
- they extend the scope of the exception by adding further authorised uses (French and Spanish model)
- they implement the exception of the EU directive into an extended collective licensing system (Scandinavian model)

The three models might present a common issue related to the cross-border dimension of e-learning. The use authorised by the collective agreement or by an extended collective licensing is normally restricted to the national territory, which leaves intact the compliance of a European distance education project with other applicable laws (see *infra*). One could also wonder what is the representation of foreign works in the three models. The list of publishers having joined the French Protocol mostly includes French publishers. The representativeness of foreign authors in systems of extended collective licensing is also a tricky question<sup>1165</sup>.

---

<sup>1161</sup> Which will be the case of educational establishments organised by another Ministry than the Ministry of Education.

<sup>1162</sup> P. LESCURE, *op. cit.*, p. 436.

<sup>1163</sup> *Ibidem*, p. 438.

<sup>1164</sup> See <https://www.conlicencia.com/Conlicencia/Sectores.html>.

<sup>1165</sup> See S. DUSOLLIER & C. COLIN, Les perspectives de légitimation des échanges des œuvres sur les réseaux *peer-to-peer* en Belgique, in C. Doutreloup, F. Dubuisson, A. Strowel (eds.), *Le téléchargement d'œuvres sur Internet – Perspectives en droits belge, français, européen et international*, Bruxelles, Larcier, 2012, p. 302.

## C. Assessment of the exception for teaching – Issues and uncertainties

### 1. Adequacy of the exception in the directive

The exception laid down in the Article 5(3) a) of the directive is an open-ended provision: it only limits the exempted use to a twofold purpose, illustration for teaching and scientific research, and to non-commercial purposes.

By contrast to the exception for acts of reproduction by libraries that could not foresee the tremendous development of digital libraries, the development of e-learning was already considered by the European text and the exception was clearly intended not to discriminate between classroom teaching and online education. One recital is explicit in that regard and the preparatory work of the directive makes several references to new media for education. Many activities by teachers and students could enter in the ambit of the exception as it refers to “use” and to a notion of “illustration” for teaching that can be broadly construed.

The exception is therefore adequate in itself to address the needs of education and e-learning.

The Green Paper on Copyright in the Knowledge Economy of 2008 comes to a similar conclusion and rather points at the often too restrictive national implementations of the exception<sup>1166</sup>.

### 2. Restrictive national transposition

The open-ended content of the exception for teaching left ample manoeuvre for the Member States to enact the conditions under which the exception could be enjoyed. Nothing prevents domestic laws to further define the beneficiaries, the types and quantities of works that can be used, as well as the type of use.

When dealing with new digital uses, one recital of the directive requires that “the provision of such exceptions or limitations by Member States should, in particular, duly reflect the increased economic impact that such exceptions or limitations may have in the context of the new electronic environment”<sup>1167</sup>. Combined with the principles of a high level of protection of the copyright and related rights and of the three-step test, Member States are allowed to and should determine conditions for uses in a e-learning context that would limit a possible adverse impact of any educational use on the exploitation of the works and other subject-matter.

This explains and justifies that Member States, when transposing the directive, have paid attention to the boundaries of the educational exception, particularly when the exempted use could cover the making available of works online. We have seen that generally such transmission of works should be limited to the students enrolled to the course and/or to the closed networks of the establishments.

Some Member States have however been warier and have limited the dissemination of works used for illustration for teaching to the classroom or the physical premise of the school or university, which in practice prevents the development of e-learning programs.

The exclusion of e-learning uses from the scope of the exception is the first concern resulting from some domestic laws.

---

<sup>1166</sup> *Green Paper on Copyright in the Knowledge Economy, op. cit.*, p. 17-19.

<sup>1167</sup> Recital 44.

A second concern comes from the complexity and diversity of the conditions imposed to the use for teaching in most Member States, as to the type of works or the quantity thereof that can be used. This complexity, that could probably be mastered by teachers accustomed to their national system, becomes difficult to tackle when several laws need to be complied with, due to a cross-border dimension of e-learning that requires the application of more than one law.

Due to such diversity, the exception for illustration for teaching cannot be said to be harmonized at the European level<sup>1168</sup>, which renders the task of developing a legally compliant offer of online education all the more daunting. Such a lack of harmonization is mainly exacerbated by the cross-border dimension of e-learning<sup>1169</sup>.

### 3. Distance learning

The significant differences that exist in national laws as to what educational uses and under which conditions they are authorised become real obstacles when the teaching occurs partially or totally on-line in an e-learning program or supported by e-learning tools<sup>1170</sup>. To assess the difficulty, this part will first analyse the cross-border dimension of e-learning in different models (a.), then it will address the impact of this transnational exploitation on the localisation of the use, required to determine which law applies (b.), and finally the effect on the fair compensation system that is applied to the exception for teaching in many Member States (c.).

#### a) The cross-border dimension of e-learning

By definition, when some content is made available online, even in a closed network, there is no way to prevent it from circulating across borders. However, the cross-border dimension of e-learning will have different shades and degrees:

1. ***E-learning as a supplementary tool offered to students enrolled in a course:*** Most courses delivered at the universities, and increasingly also at primary and secondary schools, will rely on additional webpages that could host supplementary materials, assignments, copies of presentation made by the teacher, exercises... As a principle, the cross-border dimension of the use that could be made of such webpages will be rather limited. Should their access be restricted to the students and pupils enrolled in the course<sup>1171</sup>, the use of copyrighted works and other protected subject matter in the material that is posted on the webpages will in the vast majority of cases take place in the territory of the educational institution, the students concerned normally residing in the same country. Some limited acts of access to the content from another territory might be from students living across the border (e.g. when the university or school is established in a frontier zone) or from students temporarily travelling abroad (e.g. Erasmus students or students studying or making their assignments when on holidays). Similarly, the teacher or teaching assistants in charge of the course or of the webpages might sometimes post content from another country than the State in which the educational institution is located.

---

<sup>1168</sup> L. GUIBAULT, Why cherry-picking never leads to harmonization, *JIPITEC*, 2010/1, p. 62; S. ERNST & D.M. HAEUSERMANN, Teaching exceptions in European copyright law – Important policy questions remain, Berkeley Center for Internet and Society, Harvard Law School, Research Publication n° 2006-10, August 2006; R. XALABARDER, On-line teaching and copyright : any hopes for an EU harmonized playground ? , *op. cit.*, p. 395.

<sup>1169</sup> See below for a thorough analysis of this dimension in e-learning.

<sup>1170</sup> Our analysis will focus on e-learning and not on other forms of distance learning (e.g. using broadcasts, sending of teaching materials by post, ...) as those are increasingly substituted by the Internet media.

<sup>1171</sup> This might not be the case due to a lack of consideration of this limitation by the teacher or the institution itself. As a consequence, the webpages and the copyrighted works included in the educational material it contains, might be accessible from anyone and from any territory, which will add a cross-border issue.

The territories concerned by the possible use of protected material will be *primarily* the States where the educational institution is established and where its students live, and *incidentally*, the States from where the students might occasionally get access to the course, and the teacher might occasionally post some content.

2. ***E-learning offered as a stand-alone educational course by one university:*** Many universities<sup>1172</sup> have a distance learning program in which they offer courses to be followed wholly or substantially through the internet, with no required presence in a physical classroom, even for exams. In such a case, the physical location of students might be very diverse which might bring a more intense cross-border dimension<sup>1173</sup>, when such virtual education by universities targets non-local students and aims at attracting students from other countries thanks to the Internet media. Depending on the course, non-EU students could also form a large base of the students. The territories concerned by the possible use of protected material will be: the State where the educational institution is established, and the States in which the students accessing the course reside. As in the previous case, other States could incidentally be involved depending on the mobility of the students and of the teachers.
3. ***E-learning in MOOC:*** MOOCs, by virtue of their openness and their intended global reach, do not by nature discriminate the students by their nationality or place or residence. Consequently, the student audience of a MOOC will be largely international, depending only on the language in which the course is given. The territories concerned by the possible use of protected material will be the State where the educational institution is established, as well as an undefined number of States where the students follow the course.
4. ***E-learning offered by a virtual organisation:*** e-learning modules can also originate from transnational collaborations between universities, that pool their teaching and technical services to provide a specific program targeted at students enrolled in the partner institutions or more broadly to students from any origin. The European Union has funded a number of initiatives from universities and higher education institutions to develop common e-learning offers and programs. They add some complexity to the cross-border dimension, as the courses might be hosted on the servers of different universities in different States, and teachers might intervene on the content from many locations, not being necessarily in the same State than the university that delivers the course, organises the program or hosts it on its servers. The territories concerned by the possible use of protected material will be: the States where the educational institutions collaborating to the e-learning program are established, and the States in which the students accessing the course reside. As in the previous cases, other States could incidentally be involved depending on the mobility of the students and of the teachers.

In addition, technical features of e-learning could play a role as well. Whatever the model of the e-learning service, some cross-border dimension can simply result from the place where the server hosting the teaching material is located. When the course is provided by one university to its students, whether as an extra tool to face-to-face teaching, as a specific module or as a MOOC, the educational content will generally be hosted on the servers of the university itself, normally physically located in the same territory than the establishment. However, that might be otherwise if the university have recourse to dedicated platforms providing technical e-learning services or to cloud hosting.

---

<sup>1172</sup> It will be rather rare that schools develop online courses, but it could happen as well.

<sup>1173</sup> Such programs will not be necessarily international as it can be directed to students of the country of the establishments, namely by reason of the language or topic of the course.

## b) Impact of the cross-border dimension on the localisation of the use

The application of the exception for illustration for teaching shall normally be governed by the law of the State where the educational use, that will generally be a mix of reproduction and making available, occurs. Indeed, the rule of applicable law, according to the Berne Convention, is where protection is claimed (rule of the *lex loci protectionis*). It needs to be combined with the principle of territoriality of copyright that commands that the exceptions provided by one national law only applies to the acts of use occurring in its territory.

The assessment of whether some use is a copyright or related right infringement or could be excused under an exception thus requires determining first the localisation of such use, hence the law under which the use could be confronted with the conditions of the educational exception. The reference to the principle of territoriality to uses of copyrighted works on-line does not automatically lead to the application of a multiplicity of copyright laws corresponding to all countries where the work can be accessed<sup>1174</sup>. Arguably, one could rather attempt to designate one single point where the use can be located in order to try and apply one single law to such use<sup>1175</sup>.

This is not an easy exercise. By definition, distance learning will involve acts of reproduction and of making available, more rarely acts of distribution. One could refer to the report delivered to the European Commission in the framework of the evaluation of the directive 2001/29 on the localisation of the making available and of the reproduction of a copyrighted work. The options proposed by this study (location of the servers; location of the material act of upload, location of the centres of activities of the uploader, location of the exploitation) and eventually adopted by the Commission will equally define the localisation of the educational use and the territorial application of the exception<sup>1176</sup>. Yet, the purpose of such localisation is rather different, as it leads here at defining whether one educational use in an e-learning program is covered by an exception, in which country and upon what conditions. By contrast, determining where an act of exploitation takes place, aims at assessing where and for which territories the exploitant should clear copyright and require the needed authorisation by the copyright owners. If several countries are determined as places of exploitation, the making available of works needs to be authorised for each country, which could create an additional burden. In the case of exceptions, the multiplication of countries relevant for the use potentially covered by an exception could lead to situations where the use is not authorised in one country or at too restrictive conditions, which could defeat the cross-border use, even if legitimate in other countries.

The four models of e-learning, depending on their degree of transnational effect, could serve to identify the possible localisation of the acts of use that could benefit from an exception<sup>1177</sup>. In each model, the acts of reproduction and acts of making available that could take place in the e-learning offer and process should be analysed separately<sup>1178</sup>.

**As far as reproduction is concerned**, it covers mainly the uploading of the work or other subject matter on the e-learning platform, either as a separate material (e.g. as reading or exercise material) or included

---

<sup>1174</sup> S. RICKETSON & J. GINSBURG, *op. cit.*, §20.15. A recent decision of the Court of Justice has relied on the accessibility of on-line content in any country to determine the jurisdiction under the article 5(3) of Council Regulation (EC) No 44/2001 of 22 December 2000 on jurisdiction and the recognition and enforcement of judgments in civil and commercial matters, but has left the determination of the applicable law to decide about the infringement of copyright occurred in that jurisdiction to the national court (See C.J.E.U., Judgement of 3d October 2013, C-170/12, *Pinckney*).

<sup>1175</sup> G. DINWOODIE, *Conflicts and International copyright litigation: The role of international norms*, in J. BASEDOW, J. DREXL, A. KUR & A. METZGER (eds.), *Intellectual property in the conflict of laws*, 2005, p. 203.

<sup>1176</sup> The study referred to does not describe the actual connecting factors of an act of making available on-line but only suggests different factors that could be chosen to locate the act. Consequently, the analysis of the localisation of the e-learning relevant acts (reproduction or making available) are neither a description of the applicable legal criteria but is more a policy exercise *de lege ferenda*.

<sup>1177</sup> Or not, as the benefit of the exception will depend on the applicable domestic law.

<sup>1178</sup> See however the analysis of the Relationship between the making available and reproduction in the Report on making available.



as an extract or as a whole in some teaching material for illustration purposes. Some reproduction could also occur should the teacher need to digitize the work prior to uploading it. In interactive learning processes, students will also undertake acts of reproduction when uploading assignments they were given, or providing other students or teachers with documentation of any content illustrating the topic of the course.

Other acts of reproduction by students will happen when downloading the material, printing it or even copying it on other devices or media. Even without downloading, consulting the material online will imply temporary acts of reproduction on their computers or other reading devices. The first type of copying (downloading or printing) will normally be covered by the private copying exception, while the latter will be encompassed by the temporary copying exception. Those types of copying will thus not be analysed further in this study.

**The making available** would occur as soon as the material, including the protected works or subject matter, is uploaded on the e-learning platform and accessible to the students<sup>1179</sup>.

After this preliminary context, one can turn now to the analysis of the four models of e-learning and to their outcomes from a copyright perspective:

1. ***E-learning as a supplementary tool offered to students enrolled in a course:***

When uploading the content on the e-learning platform, whether by teachers or by students, the **reproduction** will normally take place in the country where the server is located, usually being the same than the country where the educational institution (as well as teachers and students) is located. Localising the server by a strictly *technical* approach, i.e. by looking at where the computers operating as servers are physically located, could lead to difficult situations in a cloud environment or when universities outsource the hosting of their e-learning platform. An approach based on the criteria of exploitation, as recommended by the study on the making available right, should be preferred. It would relate the use, here the reproduction, to the teaching establishment delivering the e-learning platform in addition to its teaching programs. Therefore, the location of the server should be equated to the location of the university or educational institution.

Similar reasoning can be applied to the localisation of the **making available**. The study on the territoriality and making available right has rejected a technology-oriented approach based on the location of the servers on which the work is uploaded<sup>1180</sup>. It preferred other alternatives, such as a combination of the location of the material act of upload and of the centre of activities of uploader, or the location where the exploitation is taking place. When applied to e-learning environments, the first criterion leads to the application of the law of the educational establishment operating the e-learning platform. In our first scenario, the application of the other option, i.e. the location of the exploitation (that we could transform into “use” which would be more relevant for exceptions), achieves a similar outcome. Indeed, the place where the making available is relevant for the learning process and involves an exploitation of the material is the location of the establishment operating the e-learning platform, since the teaching establishment and the students are normally located in the same territory. The occasional mobility of students or teachers during the course should not affect that conclusion as it would be in principle very limited.

As a result, the cross-border dimension of such model of e-learning is rather minimal as normally, the use of copyright works or other protected subject matter will be governed by the exception for illustration for teaching, as laid down by the Member State where the education institution is located.

---

<sup>1179</sup> No making available will occur when the educational material is uploaded on the platform but not still visible by the students. This is a technical possibility in most e-learning platforms where teachers can upload some content but decide when it will be available to the students..

<sup>1180</sup> See the part of the study on the territoriality of the making available right, for a more refined analysis and particularly as the extent of the making available right is disputed, as to whether it covers as well the transmission and download following the availability.

2. ***E-learning offered as a standalone educational course by one university:***

This becomes more complicated when the e-learning modules target students in different countries and offer teaching programs not connected to traditional classrooms teachings. The analysis just carried out for the act of reproduction would be similar. The copies should preferably be considered as made in the territory where the establishment operating the e-learning platform and servers is located, not where the servers are physically located. It should not matter as to whether the reproduction is made by teachers or students as the uploading is done on the same platform.

The making available is less easy to apprehend. The theory of upload/centre of activities still points out to the location of the educational institutions. By contrast, when applying the criterion of exploitation, as suggested by the part of this study on Territoriality, the act of making available would be located at least where the public is targeted. An e-learning program might target students of several countries and potentially, all countries where the students having enrolled for the course are located, could be considered as places of exploitation.

As a result, the application of the exception to the use of copyrighted works in the educational material proposed to students could depend on several domestic laws. This would require the educational institution to comply with the conditions laid down by different laws. It suffices that part of their students are in countries where no exception for e-learning is applicable to make illegitimate the use of copyrighted works for illustration of teaching.

3. ***E-learning in MOOC:***

The analysis of the former scenario will apply equally to MOOC with the added difficulty that by definition, the open e-learning program intends to reach a global public, hence multiplying the countries in which the educational use should pass muster with the conditions of the applicable law. The openness of the MOOC process will furthermore raise difficulties in many countries where the exception for teaching purposes will require that the educational material comprising protected works remains within a closed network based on passwords or other access controls<sup>1181</sup>.

Conversely, if one decides to apply the only law of upload and centre of activities of the educational institution, even for acts of making available, it could lead to some risk of location shopping. Universities established in countries with the broadest exception for teaching purposes would be privileged in the development of MOOCs in Europe.

4. ***E-learning offered by a virtual organisation:***

This is the most intricate situation as not only the learners are spread over several States, but the responsibility of the e-learning program and its “physical” location are not bordered anymore.

First, it has some impact on the localisation of the reproduction acts when uploading material on the platform. As some courses might be shared by more than one university or even several teachers, it blurs the connection of the applicable law to the course with the educational institution in charge of it. For instance, let's imagine that some European reputed medical schools, such as the universities of Oxford (UK), Pierre and Marie Curie (France), Karolinska Institute (Sweden), Jagiellonian University (Poland), and Heidelberg University (Germany) could offer together an e-learning program in immunology. Either each university could provide separate modules in a jointly organised curriculum or professors from each university could join to provide a common course. The course of immunotherapy would be given together by one professor from Oxford and one professor from Heidelberg, who are presumably considered as the biggest experts of the field in Europe. They would use materials from the course they give in their own university, but the module is designed in such a way that professors of the other partner universities could upload images or other content they find illustrative of the course. Therefore, teaching documentation that could include copyrighted materials could be uploaded by professors from different

---

<sup>1181</sup> Without even analysing the compatibility of an exception that would include MOOCs with the three-step test.

universities and States and the responsibility for the course would be shared by all partners. That might make the technical criterion of the location of the server more relevant. But this factor could also be rather remote from the countries in which the course is organised, if the servers are in the cloud or in a non EU-country.

For the act of making available, the difficulty is even amplified. The application of the upload/centre of activities would not lead to one single applicable law, but to many. It could incite the universities to set up a separate legal person to organise the e-learning project and to locate it in the most favourable State in terms of educational exception.

Shifting then to the criterion of exploitation would raise the same issues than in the former two models of e-learning. It would require the compliance with the law of each country of the universities participating to the e-learning program and of the countries of the enrolled students.

This long analysis reveals that the cross-border dimension of e-learning, whether minimal or massive, in combination with the uncertainty as to how to locate the use concerned by an exception to copyright and related right, potentially applies several domestic laws to educational uses occurring in distance learning, with no clear outcome as to the legitimacy of the use.

It could add much complexity for universities and other institutions developing e-learning to ascertain whether the use of copyrighted works and other subject matter by their teachers, as well as by the students, is authorised or not.

Except if a choice of one applicable law is made for the right of making available, the concurrent application of several national copyright laws to abide with the exception conditions will be unavoidable. A preferable solution might be then to further harmonize the national exceptions dealing with teaching purpose (see *infra*).

### **c) Impact of the cross-border dimension on fair compensation**

A supplementary difficulty if several laws are declared to apply to educational uses on-line would be to determine how and where to apply the levies when required by national legislators to compensate the use. When the exception for illustration for teaching is conditioned by the payment of a fair compensation to rights holders, the debtor of such levy will generally be the educational institution.

The decision of the Court of Justice of the European Union related to private copying levies could be of partial help. A first principle held by the Court is that “the notion and level of fair compensation are linked to the harm resulting for the author from the reproduction for private use of his protected work without his authorisation. (...) Since the person who has caused the harm to the holder of the exclusive reproduction right is the person who, for his private use, reproduces a protected work without seeking prior authorisation from that rightholder, it is, in principle, for that person to make good the harm related to that copying by financing the compensation which will be paid to that rightholder”<sup>1182</sup>. Applied by analogy to the exception authorizing use of works for illustration for teaching, one could consider that the harm results for the author from the reproduction or communication to the public in the context of teaching without his authorisation. Therefore, the person that has carried out such acts of use should finance the compensation. That could be the teacher or student that reproduce or communicate the work or the educational institution on their behalf. This solution appears in the Belgian law that transfers the charge of the compensation to the schools and universities.

A second question is the territorial application of the fair compensation. Here the analogy with the private copy levies might not be automatic. Indeed, the *Stichting de Thuiskopie* decision of the CJEU dealt with a cross-border situation, where the private copying occurred in one country and the importer of the blank

---

<sup>1182</sup> C.J.E.U., Judgment of 21 October 2010, C-467/08 ; *Padawan*, paragraph 40 & 45 ; C.J.E.U., Judgment of 16 June 2011, C-462/09, *Stichting de Thuiskopie*, paragraphs 24 & 26.

media, who was the debtor of the levy under the applicable law, was in another country. In such a situation, the court held that “if a Member State has introduced an exception for private copying into its national law and if the final users who, on a private basis, reproduce a protected work reside on its territory, that Member State must ensure, in accordance with its territorial competence, the effective recovery of the fair compensation for the harm suffered by the authors on the territory of that State”<sup>1183</sup>. Consequently, the fair compensation could be charged abroad for a harm suffered in one territory.

Things are different in e-learning: the cross-border gap is not between the harm and the debtor of the fair compensation but rather in the harm itself that could happen in different countries where the educational material is made available. No solution is offered by European or national laws as to the determination of the territory on which the compensation is due. One could maybe designate the educational establishment in charge of the educational program as the person responsible for paying the fair compensation. The number of students in different countries reached by the program should then count for the determination of the amount of levy. That would not solve however the determination of the responsible person in our fourth model with a shared organization of e-learning programs, nor solve the public policy conundrum relating to the potential subsidy by one Member States’ taxpayers of students in a different Member State.

---

<sup>1183</sup> *Stichting de ThuisKopie, op. cit.*, §36.

## D. Assessment of the exception for research – Issues and uncertainties

### 1. Adequacy of the exception and its national implementation

The article 5(3) a) of the directive 2001/29 refers to scientific research as one of the purposes that the exempted use can pursue without explaining any further such notion or the precise scope of the exception. As for educational purpose, the exception is only limited by a non-commercial end, a condition of proportionality and the obligation to mention the source (which would be an obligation arising from scientific methodology as well). The acts of use should not be restricted to illustration of research. That makes the exception for research rather open.

National implementations stay similarly vague, except for some countries that do not authorise derogations from copyright or related rights for the purpose of non-commercial research.

Existing case law does not show any dispute as to the scope of what could be authorised by the exception, but rather on the boundaries between commercial and non-commercial research<sup>1184</sup>. This could indicate that the existence of an exception in the legislations of the Member States has not raised any particular issue or misuse, with no certainty though by lack of empirical studies.

The only issue that could be put forward is the absence of any exception in some Member States, which could put researchers in those countries in a less easy situation than their foreign peers. Here again, no evidence has been found of the reality of such discrepancies or discrimination<sup>1185</sup>.

The distinction we have drawn at the beginning of this study between the copyrighted works used as subject matter for research or as tools for research could help to assess the issues raised by the exception in the directive or its national transposition. As to the latter category, the unfolding of the open access mandate in scientific publications might reduce the issues faced by researchers in using scientific papers for their research. Following the recommendation of the European Recommendation on access to and preservation of scientific information of July 2012<sup>1186</sup>, research institutions in the European Union are encouraging their researchers to publish their scientific papers resulting from publicly funded research in open access no later than six months after the date of publication, and twelve months for social sciences and humanities. A similar obligation applies to dissemination in open access of research data. This is an international movement also promoted by UNESCO<sup>1187</sup> and OECD<sup>1188</sup>, and followed by many national research-funding organisations. When in open access, the scientific publications and datasets can be used rather extensively for research, with respect to the integrity and attribution of the work and with no commercial purposes<sup>1189</sup>. Therefore, the need for an exception might be less relevant.

---

<sup>1184</sup> See the case law mentioned *supra* when analysing the national implementations.

<sup>1185</sup> One hypothesis is that researchers are copying works in any case for the purpose of their research with no possibility for copyright owners to enforce their rights. No collective or individual licensing seems to have developed in the absence of an exception in those countries.

<sup>1186</sup> Recommendation of the European Commission on access to and preservation of scientific information, 17th July 2012, C(2012) 4890 final.

<sup>1187</sup> UNESCO's Policy Guidelines for the promotion of open access to scientific information and research, 2012.

<sup>1188</sup> OECD Declaration on Access to Research Data from Public Funding, 2007, <http://www.oecd.org/sti/sci-tech/38500813.pdf>.

<sup>1189</sup> That will depend on the licenses applied to the scientific works disseminated in open access. Some scientists might also authorize commercial use.

## 2. The cross-border dimension of research

Research increasingly endows an international character. By all means, the use of copyrighted works by researchers might have a cross-border dimension to a lesser or larger extent depending on the field and activity of the researcher. However, most acts of reproduction and use of works and other subject matter for research will be done by the researcher in a single territory. By contrast, non-strictly national use will occur when researchers communicate to or share with colleagues some material for research, or include works in their presentations then transmitted on-line.

This cross-border dimension will nonetheless first depend on the legality of such acts of communication or transmission of works under the exception. Lacking any restriction in the exception of the directive itself, one could conclude that making copyrighted works available for research purposes might be allowed if it is strictly required for the purposes of research. In no case, the researchers could share copyrighted works for other purposes or to substitute to acquisition of the works they need to study. We will develop that point later on when discussing of what the proper scope of a research exception could be.

When acts of making available are allowed, the extent of the cross-border dimension and the localisation of the use could follow the analysis we have done for e-learning. It could be reduced to two models:

- ***the making available by one researcher or one research team from some webpage or by individual sending to peers:*** The hypothesis referred to here is the inclusion of copyrighted works in research development as examples, illustration or studied material (beyond the limits of quotation) and the making available of such scientific work to present the research, share it with colleagues or any other purpose justified by the research. Depending on the criterion chosen to localise the making available of protected subject matter, the use might be located in the country where the researcher or her university is located (upload criterion combined with the centre of activities element); in the country of the server on which the content is made available (technical criterion); or in the countries where the researchers receiving the sending are located (exploitation criterion if interpreted by the targeted public factor).
- ***the sharing of content within a common project or team comprising researchers established in different countries:*** The hypothesis referred to in this second model would be the putting together of copyrighted works that form the basic material of some common research project whose researchers or teams are spread in different States. For instance a European research network in linguistics could work on the anglicization of languages by looking at the frequency of English-based terms in national newspapers and would collect and share articles for that purpose. It would then set up a website or file hosting service, either developed by the researchers themselves or using an existing (cloud-based or not) service (e.g. Scribd, Dropbox, Google docs or other). This multiplies the connecting factors to each country of the researchers and research institutes partnering in the project, especially if the hosting space is shared out on many servers or outsourced to a service in the cloud.

As for the educational exception challenged by the cross-border development of e-learning, discrepancies between the treatment of research activities in domestic copyright laws would complicate the compliance by the scientists concerned with a possible exception.

### E. Possible options

#### 1. Overarching principles and weighing factors

Exceptions and limitations of copyright and related rights are an exercise of balancing the need for a high protection of the authors and other rights holders, as required by the InfoSoc Directive, and the public

interest and the interests of the beneficiaries of exceptions. Education and research are on the agenda of the European Union as a key objective and have often been stated in European and international legislative texts as having some weight in the copyright balance.

However the development of digital means of making available content in e-learning or collaborative research might tilt the balance differently. On one hand, the objective and public interest of education does not change when undertaken with digital technologies and on digital networks. Yet, the transmission of copyrighted works in the course of teaching is no more limited to the classroom but can potentially reach a bigger audience when disseminated on-line. Providing the students with digital copies of works to illustrate a class, rather than with photocopies, can also have a bigger impact on the substitution effect those copies might have compared to the normal acquisition of the work.

Therefore any delimitation of the exception for education or research needs to accommodate and limit the impact that such uses could have on the market of the works concerned. This balancing exercise is already achieved in the article 5(3) a) by the limitation to illustration for teaching and the overall condition that the use be restricted to what is necessary to pursue the objective.

In any case, authorising on-line use for teaching and research should not harm the exploitation of the works or unreasonably prejudice the legitimate interests of copyright owners as required by the three step test. This will guide our following reflection.

## 2. Separating education and research?

Uses of works for teaching or for research are not similar. Using extracts of works to illustrate some teaching could also be done to illustrate some scientific development during a conference for instance. But reproduction or communication of works by researchers can go beyond a simple use for illustration. Yet, both objectives have been merged in one single exception in the European directive and in most domestic laws. The exception for scientific research does not require though a limitation to illustration and appears to be broader than its counterpart for teaching.

Would the differences in scope, objectives and activities warrant a different treatment of research compared to teaching in the EU copyright exception? That has not been the case so far.

Leaving aside the question of text and data mining that is a specific act of research that deserves a particular consideration, the question of separating the two objectives in distinct exceptions with adapted conditions should be raised. Some advantages or disadvantages of such a distinct treatment will be addressed.

### Advantage(s)

Enacting a separate exception for research could better adapt the authorization to uses that matter to research for an open-ended formulation does not lead to any security, both for rights owners and for researchers. Some criteria or conditions could be helpful to better delineate the boundaries of what uses could be authorized under the exception.

### Disadvantage(s)

The exception for scientific research is very open-ended in the *acquis communautaire*. Contrary to what happened for the teaching objective, Member States have not restricted the authorised uses for that purpose and have generally left the exception as open as it is in the directive (save for the countries not allowing any exception for research ends). The same level of legal uncertainty is hence replicated at the national level. However, revising the exception for research to enact a separate provision would require defining its conditions and limits. It would restrict and disrupt an undefined scope that has not demonstrated any real issues, but remains subject to proportionality and strict interpretation. In the definition of its specific requirements, it could also be very difficult to determine the proper scope of an

exception dedicated to scientific research as the use that could be made of copyrighted works in a scientific process might greatly vary depending on the scientific field concerned.

### 3. Revising the scope of exception for teaching purposes

#### a) Keeping the status quo

The option of revising the exception for teaching is less convincing than for the library exception as nothing in the current formulation of the exception needs clarification or extension to cover newly developed uses of relevance or public interest.

The article 5(3) a), with the interpretation of the recital 42, gives all assurance that illustration for teaching can occur in the classroom or in distance learning environments. One could add that the recent case law of the CJEU insists on an interpretation of the exception that should guarantee, despite the principle of strict interpretation, that the exception remains effective and achieve its purpose<sup>1190</sup>. As the interpretation of the exception is not an issue, the text of the article 5(3) a) leaving almost no room for doubt or uncertainty and since e-learning is explicitly mentioned in the recitals of the directive as one of the objectives of the exception, revising the directive to better allow e-learning is not indispensable.

The main advantage of this position is to not re-open the exception for teaching and risk to restrict it or complicate it.

#### b) Adoption of an interpretative document

It is rather the generally too restrictive transposition by Member States that has created some issues and prevented educational institutions to fully benefit from the breathing space that the EU lawmaker has created, notably or digital learning activities.

Adopting an interpretative document or publishing guidelines could be another option for the Commission in order to remind to Member States the objective of the exception, and that distance learning activities should not be totally prohibited by the exception.

Such a document should stress the objective of the exception and its enduring relevance for on-line education<sup>1191</sup>. The open nature of the exception would be preserved without the need to detail further the conditions applying to illustration of teaching, which bears the risk of unduly restricting the exception.

However, as said for libraries exceptions, such interpretative document is not in the habit of the European Commission in the copyright field. It would not be a constraining legislative instrument to the Member States that could maintain their more restrictive approach<sup>1192</sup>. It could also come a bit late as the directive has been implemented years ago in many EU countries. And it would only repeat what is clearly stipulated in recital 42 of the directive.

Restrictions as to the scope of the exception mainly result from national copyright laws that the Member States will not modify only for the sake of complying with an interpretative document, whose legitimacy to impose such a revision at the Member States level, would be dubious. One can also doubt that national courts, when applying a national exception, would make prevail an interpretative document of the European Commission over national legal provisions.

---

<sup>1190</sup> C.J.E.U., judgment of 1st december 2011, C-145/10, Painer, §133 ; C.J.E.U., judgment of 4 October 2011, C-403/08 and C-429/08, *Football Association Premier League and others*.

<sup>1191</sup> As stated by the Communication on Copyright in the Knowledge Economy.

<sup>1192</sup> see the Opinion of Advocate General Sharpston in the case C-306/05, *SGAE v Rafael Hotels*, §45.



### **c) Modification of the exception in the directive**

A next step would be to revise the exception in the directive to better address the conditions under which educational uses, and particularly in an e-learning environment, could be undertaken. Revising the exception would limit the discretion left to the Member States due to the clear guidelines that the definition of the applicable requirements at the EU level would give to national legislators, and the application of the recent CJEU case law that stated the manoeuvre enjoyed by the Member States should not contradict the purpose of harmonization and the conditions of an exception laid down by the directive 2001/29<sup>1193</sup>.

Should the European lawmaker decide to delimit further what uses could be authorised by an exception for illustration for teaching, whether by revising the text of the directive or adopting an interpretative document thereof.

One should repeat the argument that could be made against the introduction of too many details and conditions in the exceptions of the article 5 of that directive<sup>1194</sup>, as it would imply to reach some political compromise on details rather than on the overall objective and it would result in imposing some particular legislative drafting style to Member States, at the detriment of the subsidiarity principle.

### **d) Defining the conditions of the exception in a revision or interpretation of the directive**

Should the exception be revised in the Infosoc Directive, it should address the following factors in determining the proper scope of what teaching uses would be allowed.

#### **(i) The objective of the exception**

The objective of the exception, i.e. the illustration for teaching, does not raise specific issues, despite its lack of definite scope. It appears to be a reasonable criterion that leaves some margin of appreciation and is identical to the wording of the Berne Convention.

It should be understood that teaching covers any activity related to the imparting and getting of knowledge in an educational environment, namely the illustration of lessons or exams by having recourse to works or extracts thereof as examples, demonstrations, exercises, ... Illustration is based on a link between the lesson and the work that is used, either direct when the work is the very topic that is taught or more indirect when the work helps understanding the teaching.

#### **(ii) Beneficiaries**

The current exception in the directive does not define its beneficiaries. It is generally understood that it encompasses schools and universities whatever their level, source of financing, public or private organisation. A broad construction including both teachers and students, thus any actor in a learning process, should be allowed too. The only discriminating criterion is the limitation to education carried out with non-commercial purposes, which is completely justified and never contested.

There is no need to define further the beneficiaries and it would overstep on the competence of Member States in organising their education systems. The exclusion of adult education, that is neither explicit or implicit but follows from an interpretation of Berne Convention, could be addressed, as nothing would prevent the EU from extending the exception to such education field, with the proper limits to comply with the three-step test, notably a requirement of being non commercially oriented. The exception could then benefit not-for-profit professional education and training.

---

<sup>1193</sup> C.J.E.U., judgment of 26 April 2012, C-510/10, *DR and TV2 Denmark*.

<sup>1194</sup> See *supra*.

### **(iii) Works concerned**

The directive does not limit the type or quantity of works that can be used in the context of the teaching exception. Member States have generally been more detailed, either to restrict the borrowings to extracts of works, or to exclude some categories of works such as works intended for teaching or music scores.

The **restriction to extracts** is not fundamentally justified. The use of an extract or the whole work would depend on the type of work, the purpose and the need for illustration. For instance, making students in an English course listen to a song to be able to translate or understand its lyrics would not have a bigger impact if the whole song is played rather than some extracts. Illustrating an art history course on pop art by showing only extracts of paintings would not make any sense. Even for a course on film studies, depending on the points that a teacher wants to make, screening the two hours of *Citizen Kane* might be as justified as showing only the opening sequence.

Limiting the use to extracts would equally reduce the exception to something that could look like the quotation exception.

By contrast, the **exclusion of works primarily intended for teaching** could be justified by the application of the second step of the triple test, the absence of a conflict with the normal exploitation of the work<sup>1195</sup>. The normal exploitation of an educational manual of grammar exercises is the market of teachers, students and teaching institutions and allowing its reproduction and use under an exception would contradict the three-step test.

Finally the exception for teaching could apply equally to databases and computer programs, that could constitute a topic or tool for teaching. The exception applies to databases but is limited for the *sui generis* right (see *infra*), but does not exist for computer programs, which is not justified.

### **(iv) Authorized acts**

“Use” of copyrighted works and other subject matter is the wording employed to refer to the activities authorized by the exception. This arguably covers reproduction, communication, translation and distribution, but it has sometimes been restricted in domestic laws when transposing the directive. Nothing restricts the use to some environments and use within the classroom, at distance or online, whatever the media or technology used, would be covered. There is no need to change that broad formulation.

However, should the conditions of the exceptions be defined in more detail at the European level, the use of works in e-learning should be framed in order to avoid an uncontrolled dissemination of works. Many Member States have allowed the use in e-learning upon the requirement that the making available be done in closed networks or solely to enrolled students. Both limiting criteria should apply. The condition related to the recipients of the education serves to align the limited impact of the use of a work in a teaching to a classroom whether physical or virtual. Only the students or pupils registered for the course should be able to access the material containing protected works or subject matter. This should be verified by a technical environment that secures the access only to those students, regardless of their physical locations, through passwords or other access control features. It could be required as well that technological measures be put in place to prevent misuse or downstream infringement of copyright in the content so made available to students.

That would leave MOOCs out of the exception as their defining open dimension would not fit with such a requirement. Students following MOOCs sometimes need to register for the course but the access to teaching material is generally in open access. If teaching material used contains copyrighted works or

---

<sup>1195</sup> R. XALABARDER, *Study on Copyright Limitations and Exceptions for Educational Activities*, op. cit. p. 386.

other protected subject matter, it would be available to all which would exceed a reasonable scope for the exception.

**(v) Not for direct or indirect commercial advantage**

The limitation of the teaching exception to acts carried out with a non-commercial purpose (and its proportionality exercise) should be maintained as well as the obligation to mention the source and name of the author. Both requirements can also be found in the exception of the article 10 of the Berne Convention (that refers fair practice rather than to non-commercial limitation).

**(vi) Fair compensation**

The directive only mandates the application of a fair compensation to private copying and leaves the matter at the discretion of Member States for other exceptions. Many countries apply a fair compensation scheme to the educational exception and the European Parliament had proposed, during the discussion of the directive, to require some fair compensation for the use for teaching.

Fair compensation could be made mandatory by the directive itself. It would not add difficulties as the national systems already rely on the collection of some remuneration by the educational institutions using copyrighted works, by the inherent problems of collecting and enforcing the fair compensation<sup>1196</sup>. On the contrary, an intervention at the EU level could better determine the territory of perception of a levy and the responsible person in charge of financing it in cross-border educational uses.

#### **4. Revising the scope of exception for research**

We have already addressed the need or risk of revising the exception for research as it would change an open-ended situation for better or for worse, depending on the perspective. Only the possible conditions that should be considered if one decides to amend the exception will be enumerated here.

Coming back to the activities of research that use protected content, the distinction between the use as **subject matter for research** or as **tools for research** could lead to different conditions.

As said earlier, the second category that consists in using scientific papers for research might not require a specific treatment or exception in copyright law as the development of open access models have tremendously increased the possibility to access to and use scientific papers some (limited) time after their publication. It has the advantage of fostering the dissemination of scientific publications with the consent of their authors and not by a limitation of their rights. Datasets, whether protected by the *sui generis* right or not, are also concerned by this open access movements. The EU Recommendation<sup>1197</sup> as well as the OECD Declaration on Open Access<sup>1198</sup> commend that dataset developed in publicly-funded research be made available in open access.

Text and data mining will be a specific case of use of the first category as it will apply processing and analysis tools to a huge amount of data and content, that can be protected by copyright. A specific report will be dedicated to text and data mining.

---

<sup>1196</sup> See the (bad) example of Belgium that has not applied yet the compensation scheme for educational uses, introduced in the law in 1994, but not entered into force yet due to a difficulty to reach consensus amongst stakeholders on the amount and modalities of remuneration.

<sup>1197</sup> Recommendation of the European Commission on access to and preservation of scientific information, 17th July 2012, C(2012) 4890 final.

<sup>1198</sup> OECD Declaration on Access to Research Data from Public Funding, *op. cit.*

That leaves us with the use of copyrighted works and other subject matter as material or topic of research. To some extent, such use will follow the exception for teaching as the researchers will include works they study in their scientific presentations or papers as illustrations. But other uses could also be of some importance for research.

### a) The objective of the exception

The notion of scientific research is not defined in the directive and should maybe not be as there is some common understanding of what it refers to.

In guidelines or interpretative document, some guidance could be given as to the application of the notion of non-commercial to the research activity as it would help clarify some hybrid cases, such as research undertaken in a university with the sponsoring by an outside firm, or that is intended to yield some commercial outcomes. Ancillary outcomes of the research that could elicit some revenues, such as a scientific publication or a paid lecture, should at least not count to qualify the research as commercial. The filing of a patent should not in itself ban the research made in non-commercial entities from the benefit of the exception. The patent is a mode of protection of the scientific invention that is not in itself a commercial act, only its exploitation in commercial products will be. Similarly the granting of patent licenses by a university does not indicate per se that the upstream research that has led to the patent was for commercial purposes.

However, when a spin-off is created by a university to bring the exploitation of its patent to a commercial level, any research done by the spin-off could be assimilated to research carried out for a commercial purpose, without revising the status of the research done previously within the university itself that has resulted in the creation of the spin-off.

### b) Beneficiaries

Beneficiaries of the research exception are not defined in the current exception that adopts a functional approach based on the activity of doing research. As a result, anyone could claim the benefit of the exception, irrespective of her profession, training, or relation to a recognized research institute. There is no reason to limit the notion as it would be reasonably circumscribed by the criterion of non-commercial purpose.

### c) Works concerned

We have proposed the exclusion of educational works from the exception for teaching. Should **scientific articles**, whose main market and exploitation will be the research institutions and researchers be excluded to a similar extent from the exception for research? Arguably no, for different reasons. First, the use of scientific papers will be generally authorized under the open access approach/methodology and practices that are spreading in the academic world. A very recent study commissioned by the EC DG Research estimates that 50% of the scientific papers published in 2011 in the EU, Brazil, Canada, US and Japan, are available in open access, which comprises the publication in open access journals or the making available on-line after a publication in a traditional subscription-based model<sup>1199</sup>. This proportion will probably increase as the funding sources require the outcome of research to be in open access, as it will be the case with Horizon 2020 program. The exception will not be necessary then. Second, an exception that would allow for the use of scientific papers would only authorize their reproduction or communication if the user has a legitimate access thereto. The exception should not be a way to get

---

<sup>1199</sup> E. ARCHAMBAULT, D. AMYOT, P. DESCHAMPS, A. NICOL, LISE REBOUT & G. ROBERGE, *Proportion of Open Access Peer-Reviewed Papers at the European and World Levels—2004-2011*, August 2013, Produced for the European Commission DG Research & Innovation, RTD-B6-PP-2011-2: Study to develop a set of indicators to measure open access, available at [http://www.science-matrix.com/pdf/SM\\_EC\\_OA\\_Availability\\_2004-2011.pdf](http://www.science-matrix.com/pdf/SM_EC_OA_Availability_2004-2011.pdf).

access to the scientific paper by bypassing its normal acquisition by the market, at a library, or under a free dissemination under open access. Should the sharing of scientific papers be allowed under an exception, it should be strictly limited to a closed circle of researchers and to the extent it is necessary for the research they do in collaboration, and not only easier to get access to the papers.

In research, by contrast to illustration for teaching, the exception could pertain also to **unpublished works** that could constitute significant sources for research in some fields. However no rule in the *acquis communautaire* settles this issue that depends on the copyright tradition of Member States. For the sake of research though, some derogation from the exclusion of the application of exceptions to unpublished or undisclosed works, when such a principle exists, could be done by domestic laws. It would not harm the legitimate interests of the copyright owners, whether the author or his heirs, if the rule is limited to research and not publication of the unpublished works in question.

To enhance harmonization in the *acquis*, the exception could cross the different subject matters and apply as well to **computer programs and databases**. If computer programs know an exception for studying and testing the functioning of the program that could be equivalent to research purposes, the issue is important for the re-utilization of databases that is not exempted from the *sui generis* right. Research in scientific fields with an intensive use of data will manipulate datasets that could qualify as databases<sup>1200</sup>. The absence of an exception to the *sui generis* rights that allows for the extraction and re-utilization solely for research purposes is detrimental to research in those fields.

#### d) Authorised acts

The case of text and data mining set aside, the use allowed for research purpose could be reproduction and communication, as well as distribution if required. As far as communication is concerned, particularly through digital networks, some limitation of the dissemination of works could follow from the general restriction to the extent necessary for the purpose to be achieved. When using copyrighted works as material for research, such material could be made available to researchers but only if it is required for the research undertaken in common. The exception of quotation constitutes another possibility for the researcher to disseminate the outcomes of her research, including some extracts or reproductions of works for a scientific purpose.

#### e) Other conditions

The **fair compensation** that is foreseen in most Member States for education generally absorbs the use made by the same institutions, but most notably universities, for research purposes. It is justified for the harm suffered by copyright owners will be similar when the work is used to illustrate a teaching or to do research. Therefore, if a fair compensation is mandated at the EU level, it should include uses for research.

The **mention of the source and name of the author** should be one condition to benefit from the exception for research, as it is the case with the exception for illustration of teaching. This is all the more relevant as the mentioning of one's source is a methodological requirement of scientific research, in all disciplines.

---

<sup>1200</sup> J. Reichman & R. Okediji, *op. cit.*, p. 1415-1420.

## 5. Efforts towards more harmonisation in Member States

### a) Making the exception mandatory

A comprehensive harmonization of the exception in all Member States could be better obtained by making it mandatory. We have proffered three grounds for granting a mandatory nature to copyright exceptions under EU law:

1° **Internal Market operation:** an exception should be mandatory for Member States when inconsistent implementation would distort and create discrepancies in the Internal Market. E-learning reveals some fragmentation of the digital market for education due to the diverging exceptions in domestic laws. This would constitute a primary justification to make the exception for illustration for teaching mandatory. This is not the case for uses for research that has a more limited cross-border impact.

2° **Fundamental freedom recognised by the EU Charter on Fundamental Rights:** when the exception is grounded on the need to enable the exercise of a fundamental freedom that is part of the EU Charter, such as the freedom of expression, the freedom to information or the freedom to conduct business, it can be argued that such exception should be part of the copyright framework in all Member States. The fundamental right to education is recognised by the article 14 of the Charter, but that does not mean that the enjoyment of such right would be impaired by the lack or insufficiency of an exception from copyright to conduct teaching.

3° **European public interest:** When exceptions convey a public interest that can be declared of an European Union importance, namely by key policy documents of the EU, they could also require some uniformity in their national application. The development of e-learning and of a European research space could be declared as being of an European public interest, even though, contrary to the case of digital libraries, no such acknowledgement has been made by the European Union. As developed for the libraries exceptions, the accent put on development of e-learning and research would not necessarily mean that copyright should accommodate such a public objective by an exception. However, when such an exception is included in the directive and in almost all Member States, its European dimension could arguably promote to make it mandatory.

A mandatory exception allowing for acts of illustration for teaching and research could either be precisely worded and identify all applicable requirements or could only indicate some minimal conditions in critically important areas while imposing a precisely defined objective. Mandating the transposition of the exception under already precise conditions will limit the leeway for Member States.

The advantages and disadvantages of making an exception mandatory have already been exposed for the library exceptions. It would create some legal certainty as to the scope of the exception and increase harmonization amongst Member States that will be prevented from diverging from the exception as laid down in the EU directive. The interpretation of the exception and of its conditions then becomes a matter for the European Court of Justice that can develop an autonomous and uniform principle of copyright law. It also has the advantage of giving some weight to the clear intention of the European Union to develop a European offer of e-learning, not necessarily at the expense of the protection of copyright.

However, the selection of exceptions to be upgraded to a mandatory status would be much disputed. It would also impose to Member States their policy choices in the way of achieving the objectives of the directive. Some harmonisation of exceptions amongst Member States by imposing the conditions and wording of an exception could also run counter to the national traditions and cultures of legal terminology, methodology and copyright.

## b) An optional-exception with precisely defined conditions or objectives

A less radical option would be to adopt an optional exception with precisely defined conditions (as to the types of works, copies, purposes, as developed above) or with a prescribed objective. The harmonization effect could then be supported by the CJEU decision in the *TV2 Denmark* case that has stated that: "(...) although it is open to the Member States (...) to introduce an exception (...) into their domestic law, an interpretation according to which Member States which, exercising that option afforded to them by European Union law, have introduced an exception of that kind, are free to determine, in an unharmonised manner, the limits thereof, (...) would be contrary to the objective of that directive (...), inasmuch as the limits of that exception could vary from one Member State to another and would therefore give rise to potential inconsistencies"<sup>1201</sup>. In other words, even if Member States are free to implement an optional exception of a European directive, they are not allowed to undermine the objectives of the exception in the directive and an exception should be interpreted in a way that enables their effectiveness and the achievement of their purpose<sup>1202</sup>. As a result, Member States should implement the exception so as to abide by the objective ascribed by the directive<sup>1203</sup>. When the conditions of the exception are detailed in the directive, the discretion left to Member States is reduced accordingly.

Recitals of a revised directive or an interpretative document could then elaborate on the objective of the exception, hereby limiting a diverging application of the exception by the Member States.

As said for the library exception, this option has the advantage that it does not impose a standard exception from which nothing can be changed, but only prescribes an overall objective that the domestic laws have to achieve. This would leave some diversity amongst the Member States, without unduly impeding the development of cross-border e-learning or research.

## c) Solving cross-border issues

The previous options aim at enhancing harmonisation of exceptions amongst Member States with the objective of decreasing incompatibility between different laws that could apply to some cross-border use of copyrighted works.

Other mechanisms could help lessen the impact of unharmonised copyright exceptions, but have not been put to test yet.

The idea would be to authorise the distribution or making available of some content legitimized by an exception in one Member States to other countries. It would require first to designate the initiating act of the use that should comply with the conditions of exceptions in the territory where this use occurs, then to stipulate the requirements to be satisfied for leaving the use unchallenged by the other copyright laws that could apply to the circulation of the content. This solution could be a sort of **principle of mutual recognition** of the exception. For e-learning, it would mean that the inclusion of copyrighted works in some educational material (text, syllabus, textbook, powerpoint presentation, exam, ...) by a teacher complying with the conditions of the exception in her country (or rather in the country whose law would be considered to apply to the initiating use), would be deemed to be legitimate in the other Member States where the work would be made available to students. It would in a way circumvent the normal application of the laws of each country where the exploitation takes place.

---

<sup>1201</sup> C.J.E.U., judgment of 26 April 2012, C-510/10, *DR and TV2 Denmark*, paragraph 36.

<sup>1202</sup> C.J.E.U., judgment of 1st december 2011, C-145/10, *Painer*, §133.

<sup>1203</sup> C.J.E.U., 26 April 2012 *DR and TV2 Denmark*, C-510/10, § 36; see also *Football Association Premier League and others, op. cit.*, §163-164, related to the exception for temporary copying.

Related principles, though not identical, can be found in two legal texts, the European directive on orphan works and the recent WIPO Treaty of Marrakesh on the exception for visually-impaired people<sup>1204</sup>.

The directive on orphan works<sup>1205</sup> creates an exception allowing the making available of works by libraries provided that some conditions are respected. One triggering factor for this exception is that the work be considered as orphan after a diligent search. The directive provides that the diligent search be undertaken in the country of first publication of the work. Having passed the scrutiny of the diligent search standards in that country, the search should not be done in other Member States that should recognise the validity of the search carried out abroad. The mutual recognition applies amongst States as to the diligence of the search and prevails over different approaches in the Member States to the recognition of orphan work status<sup>1206</sup>. This designation of the country in which the search should be done has a cross-border effect as explained in the recital 23 of the directive: "In order to foster access by the Union's citizens to Europe's cultural heritage, it is also necessary to ensure that orphan works which have been digitized and made available to the public in one Member State may also be made available to the public in other Member States".

This is slightly different from the recognition of the legitimacy of one use in a State to the effect to authorize further circulation or making available in other territories. The principle of the orphan works directive does not set aside the application of the exception that each Member States will apply to libraries on their territories for making orphan works available. It only recognizes the status of the work.

The Marrakesh Treaty deals with the distribution or making available of a copy of a work in a format adapted to the needs of visually-impaired people. Its article 5(1) provides that "Contracting Parties shall provide that if an accessible format copy is made under a limitation or exception or pursuant to operation of law, that accessible format copy may be distributed or made available by an authorized entity to a beneficiary person or an authorized entity in another Contracting Party". This is a complex system whose interpretation is not clear. An agreed Statement adds that "nothing in this Treaty reduces or extends the scope of exclusive rights under any other treaty" and a number of safeguarding clauses ensure that once distributed or made available in another country, the adapted format would stay within the confines of the exception as decided by the Treaty and according to the article 4(a) of the Treaty, by its own domestic law.

At least this solution points at the difficulty for beneficiaries of an exception to comply with multiple conditions applicable in different national laws and proposes some limited circulation of works compliant with the exception in their "country of origin"<sup>1207</sup>.

A more elaborate principle of a cross-border recognition of an exception in one State might be envisaged at the EU level to tackle the compliance of e-learning with many systems of exceptions, as well as other exceptions raising a similar transnational issue. Its requirements or elements would be:

- the designation of the country under which the scrutiny with the exception conditions should be done;
- the definition of the requirements applicable for the further circulation of the content compliant with the exception in one country to other Member States.

This solution would not be devoid of difficulties though, such as:

---

<sup>1204</sup> Marrakesh Treaty to facilitate access to published works for persons who are blind, visually impaired, or otherwise print disabled, adopted by the Diplomatic Conference of 17-28 June 2013.

<sup>1205</sup> Directive 2012/28/EU of the European Parliament and of the Council of 25 October 2012 on certain permitted uses of orphan works, OJ L 299/5.

<sup>1206</sup> See the recital 8.

<sup>1207</sup> Country of origin is put in quotation marks to indicate that it has not meaning of the rule of country of origin in the Berne Convention.



- A preliminary condition would be some harmonisation of the exception (going beyond the current state of harmonisation by the directive 2001/29) to prevent forum-shopping and the choice, by e-learning projects, of the law that would be the more generous. The risk can be mitigated by the fact that educational establishments are rather stable and connected, for administrative and organisational reasons, to one territory;
- the application of fair compensation schemes that would require an additional rule determining the place where the compensation should be paid and the people responsible for such compensation, while taking into account the impact of the circulation in many territories in the determination of the amount of compensation;
- it could require the use of technological measures to prevent some misuse of the work due to this facilitated circulation.

## **6. Facilitating copyright clearance and collective agreements**

Without harmonising further the exception for research and teaching, the European Union could also promote the recourse to collective licensing and model agreements for the uses that would not be covered by the exception. This option has been explained in the report on libraries but would be different here. When discussed for the exception of preservation by libraries, recourse to licensing and collective agreements aimed at filling a gap that the European lawmaker would have left if deciding not to cover mass-digitization by the exception.

By contrast, the current exception for teaching or research does not exclude some uses whose coverage would be desirable. Therefore collective agreement would not make up for something that is missing under the directive exception. Adopting some collective agreement or Memorandum of Understanding in that field, hence appears irrelevant.

By contrast collective agreements on the national level have been concluded to fill in the lack of an exception for e-learning or other educational uses. In those countries, like France or Spain, the recourse to collective agreements has been criticised for being incomplete or intricate to manage and the solution of an exception is argued for.

That does not prevent countries with a tradition of extended collective licensing to apply this mechanism as a way to implement the exception for teaching and research, as it is the case in Sweden and Denmark.

## Conclusion

Exceptions for the benefit of libraries, teaching and research have always been high on the copyright agenda, as limitations with a strong public interest motive and an evolving context that merits on-going evaluation and revision.

Recent policy papers of the European Union have asked whether those exceptions would need to be assessed and adapted to the information society and new developments of digital libraries or e-learning. Indeed, libraries increasingly engage in digitisation or making works available on-line either for consultation or for lending. Similarly, education has now embarked the digital train, as schools and universities provide additional digital tools to students or whole curriculums to be followed online. Libraries, archives, museums or educational institutions deal with copyrighted content and other protected subject matter on a daily basis. A significant part of the collection of libraries, archives and museums is composed of books, works of arts, films, broadcasts, even music or videogames. Consequently, any act of reproduction or making available is likely to infringe copyright or related rights if not covered by an exception. The case of teaching is different: teachers and students in imparting or getting knowledge will sometimes have recourse to literary or artistic works as examples, illustration or exercises for the teaching. Whether in the physical classroom or in a virtual environment, extracts of or whole works might be copied, distributed or made available in a way that necessarily triggers copyright questions. Research will also work on protected material as a topic or tool for research and acts of copying or circulation might ensue.

Exceptions are traditionally granted to libraries, archives, museums, educational and research institutions. However the expansion of their activities on the web brings about a different impact on copyrighted works. The use of works is not confined within the limits of the library premises or within the classroom, but could be accessed on-line and potentially by a larger number of people. In some cases, one can even fear that libraries and educational institutions become competitors to the exploitation of works. Lending of e-books by libraries through downloading closely resembles to the access to digital content on digital books platforms.

If the exceptions in that field undoubtedly deserve some attention, the changing scope and ambit of their digital uses also requires that any adaptation thereof takes into account the protection of the rights in interests of copyright and related rights owners.

This study has looked at the four exceptions (or rather three exceptions and the peculiar case of public lending right) that are mostly relevant for libraries, archives, museums, educational and research institutions. They present different issues and lead to different conclusions.

Three exceptions concern activities undertaken by libraries and similar institutions, whose mission is to collect, maintain, preserve and make available our cultural and scientific heritage. A fourth one is related to the transmission of knowledge by education or research.

The InfoSoc Directive allows libraries to carry out certain acts of reproduction without specifying their purpose. It is generally understood as covering acts that aim at preservation and archiving. However the restriction of the exception to 'specific' acts of reproduction arguably excludes large-scale digitization of libraries' collections. Digitization of works to ensure format-shifting is also questionable. The national transpositions of the limitation are equally or sometimes even more restricted, which leads to only a partial harmonization that could have effect on the capacity of libraries to operate on equal footing in European projects of digitization and transmission of cultural heritage.

Another minor activity of libraries benefits from an exception in the InfoSoc Directive in order to authorize the making available of items of libraries' collection on the premises and on dedicated terminals.

Compared to the exception for preservation, its scope is precisely defined by the directive, which leaves no much leeway for Member States. National legislations have generally literally transposed that

exception, which leads, compared to the former situation, to a rather harmonised field in the European Union, except when Member States have not transposed the exception.

The issue here is different, since the exception itself has proven to be somewhat restrictive: only the consultation on the premises of the library or archive and on dedicated terminals is allowed, which has been denounced as technologically outdated. This spatial and technical restriction seems at odds with the demands of libraries' users and notably with researchers to get a remote access to some items of the libraries for mere consultation and research. However, any opening of remote consultation in some cases could bring the exception to a new level and to competition with the making available of works by the copyright owners themselves.

The extension of public lending rights to the provision of digital content on-line raises a completely new issue. Though discussed at the time, the making available of works online for lending is not comprised in the definition of lending and of public lending in the Rental and Lending Directive of 1992. For that reason, the current pilots experiences of e-lending are based on licensing contracts between libraries and publishers or intermediaries that have developed dedicated platforms for lending of e-books.

The question here is not the adaptation of a current exception or its efficiency to deliver its purpose, but rather the updating of a limitation of copyright to a completely new level. The impact of development of digital lending by libraries, under an exception, would merit some economic assessment, to substantiate (or not) the fear of a direct competition with the digital platforms and the nascent market of e-books. On the other hand, excluding new digital content from the offer of public libraries and their essential role in providing access to cultural items to the whole population could result in the disappearance of libraries altogether that have always acted as an important channel for diffusion of culture, particularly to the youth and the low-income population.

Finally the exception for teaching and research appearing in the InfoSoc Directive is another example of an open-ended limitation that is mainly defined by its two-pronged objective: illustration of teaching or research. None is really defined or delimited. Contrary to the preservation exception for libraries, the European lawmaker had already envisaged the digital extension of educational activities and explicitly includes e-learning in the scope of the exception. The issue results instead of a too restrictive transposition and diverging conditions in the laws of Member States. The ensuing lack of harmonisation is particularly problematic as this exception encompasses acts of making available and has potentially a considerable cross-border effect.

These four distinct limitations to copyright and related rights warrant different solutions or recommendations.

The exception for specific acts of reproduction is not capable to address the major challenge of digitization that digital libraries face. A first choice has to be made as to whether the task of digitization, increasingly required from national Governments and the European Union, should be helped by an exception to copyright or should rather be enabled by facilitating licensing devices, based on collective management or not. Should the revision of the existing exception be preferred, the primary question will be to define the acts of preservation and archiving (or of any other purpose) that should be allowed. If restoration and replacement, even preventively, are already covered, should the exception extend to encompass reproduction for format-shifting and mass digitization? We have developed the opinion that such copying in digital format is in itself not impairing the normal exploitation of the works or the legitimate interests of copyright or related rights owners, so far as the making available is not included in the scope of the exception.

The exception for on-site consultation is too narrow. A number of opinions concur on that point. Its corset should be loosened but up to what point? The dedicated devices could be replaced by any device enabling to view the content, but on condition that the work is only accessible in a protected format that would forbid its further copying or transmission. A more intricate question would be to enlarge the notion of 'premises' of the library, archive or museum so as to include remote consultation. If it could be envisaged for certain types of content and for strictly research purposes, it could not compete with exploitation of the works concerned by the rights owners. The dividing line might be difficult to draw.

Allowing public lending by online transmission of works such as e-books, music or films would in our view pursue the key role of libraries as providers of culture. By definition, it will be a mode of access to works competing with the market, as it has always been. However, some conditions and limitations should be imposed to e-lending to introduce similar frictions between the normal acquisition of a book and the access thereto through a library so as the former continues to be favoured by users. Particularly, a limited time of lending and number of simultaneous readers, an embargo period leaving some priority to the commercial release of a work, and the affixing of technological measures of protection, would guarantee that the offer by libraries do not hamper the development of the market for digital products, such as e-books.

The exception for illustration of teaching and research does not need to be revised as it is sufficiently adapted to the needs of e-learning and research, due to its open formulation. Nevertheless, the lack of harmonisation in that field should be reduced either by imposing the exception to Member States or to require that its objective be effectively met by the exception. By default of a comprehensive harmonisation as to the conditions of the exception, some attention should be given to cross-border situations of teaching as research, which makes it almost impossible to comply with the diversity of requirements of the many legislations that could be of application.

As to research, it was generally absorbed by the general exception for teaching, even though the concerned uses might greatly differ from the educational context. Maybe it is time to separate both objectives in two distinct exceptions that different activities would deserve.

An additional difficulty brought by the digital development is the blurring of boundaries of each exception. The three exceptions in favour of libraries had distinct fields of application: one for the acts of reproduction made for the needs of the preservation of the collection, another for the on-the-spot consultation of some items, and the last one for the lending of physical copies of works. The analysis of the three exceptions reveals some overlaps between those uses. The large-scale digitization projects ultimately aim at the making available of the collection, even though this last use should not be covered by an exception; the making available for consultation is increasingly requested to apply at distance and online; and the lending is shifting to cover the online transmission of digital items. The exception-by-exception reasoning, which is the model of the InfoSoc Directive, might not be relevant anymore. Maybe it is time to look at different uses that some categories of users (libraries or educational institutions) or some objectives (access to culture and knowledge or education) would be privileged to undertake under a limitation of copyright. Without going as far as introducing a general provision of fair use in the European copyright law<sup>1208</sup>, the space of non-infringing uses could be defined by their objective and some general conditions, including a more open requirement that the use does not exceed what is necessary for its objective. This is a radical move that this study has not made. It could make our system of exceptions more fit for its purpose and understandable for users and copyright owners alike. If the requirements for each exception are adequate and legitimate, it would not sacrifice the high level of protection of copyright and related rights that the EU law has adopted. The next step would be to make mandatory some key exceptions that convey fundamental European public interests, such as the safeguarding of European cultural heritage or the development of a European research area and internal market for education. When those objectives are encumbered by the discrepancies resulting from diverging national implementations, harmonisation of exceptions, with proper conditions and restrictions, might be as important as harmonisation of exclusive rights that was achieved in 2001.

---

<sup>1208</sup> In that direction, see the proposal of HUGENHOLTZ (B.) and SENFTLEBEN (M. R.F.), *Fair Use in Europe. In Search of Flexibilities*, Amsterdam, 2011, <http://www.ivir.nl/publications/hugenholtz/Fair%20Use%20Report%20PUB.pdf>. An attenuated version of a fair use provision is also proposed by the Wittem Copyright Code drafted by European copyright academics.

## Bibliography

### Books

ALAI study days - *The boundaries of copyright : its proper limitations and exceptions*, University of Cambridge, 14-17 September 1998

ALIX (Y.) (ed.), *Droit d'auteur et bibliothèques*, Paris, Cercle de la Librairie, 2012

BENABOU (V.-L.), *Droits d'auteur, droits voisins et droit communautaire*, Bruxelles, Bruylant, 1997.

BENABOU (V.-L.), *L'exception au droit d'auteur pour l'enseignement et la recherche ou la recherche d'une conciliation entre l'accès à la connaissance et le droit d'auteur*, 2002, <http://edutice.archives-ouvertes.fr/edutice-00000031>.

BORGHI (M.) and KARAPAPA (S.), *Copyright and Mass Digitization*, Oxford, Oxford University Press, 2013.

BRISON (F.) & VANHEES (H.) (eds.), *LA loi belge sur le droit d'auteur. Commentaire par article. Hommage à Jan Corbet*, 3<sup>e</sup> éd. revisitée, Bruxelles, Larcier, 2012.

CORNISH (W.), LLEWELYN (D.) and APLIN (T.), *Intellectual Property: Patents, Copyright, Trade Marks and Allied Rights*, 7<sup>th</sup> ed., London, Sweet & Maxwell, 2010.

DERCLAYE (E.), *The Legal Protection of Databases. A comparative analysis*, Cheltenham, Edward Elgar, 2008.

DREIER (TH.) & HUGENHOLTZ (B.) (eds.), *Concise European Copyright Law*, Alphen aan den Rijn, Kluwer Law International, 2006.

DUSOLLIER (S.), *Droit d'auteur et protection des oeuvres dans l'univers numérique – Droits et exceptions à la lumière des dispositifs de verrouillage des œuvres*, Bruxelles, Larcier, 2005.

GALOPIN (B.), *Les exceptions à usage public en droit d'auteur*, Coll. IRPI, vol. 41, Paris, LexisNexis, 2013.

GOLDSTEIN (P.) and HUGENHOLTZ (B.), *International Copyright, Principles, Law and Practice*, Oxford, Oxford University Press, Second Edition, 2010.

GUIBAUT (L.), *Copyright Limitations and Contracts. An Analysis of the Contractual Overridability of Limitations on Copyright*, The Hague, Kluwer Law International, 2002.

HUGENHOLTZ (B.) and OKEDIJI (R. L.), *Conceiving an International Instrument on Limitations and Exceptions to Copyright. Final Report*, 2008, [www.ivir.nl/staff/hugenholtz.html](http://www.ivir.nl/staff/hugenholtz.html), 55 p.

IGLESIAS (M.-J.), *Limitaciones docentes a la propiedad intelectual: derecho internacional español y comparado y opciones de política legislativa*, tesis doctoral, Universitat de les illes Balears, Facultat de derecho, Palma de Mallorca, 2007.

KUR (A.) and DREIER (TH.), *European Intellectual Property Law. Text, Cases & Materials*, Cheltenham, Edward Elgar, 2013.

LINDNER (B.) & SHAPIRO (T.) (ed.), *Copyright in the information society: a guide to national implementation of the European Directive*, Cheltenham, Edward Elgar, 2011.

LUCAS (A.), LUCAS (H.-J.) and LUCAS-SCHLOETTER (A.), *Traité de la propriété littéraire et artistique*, 4<sup>th</sup> ed., Paris, LexisNexis, 2012.

MASSOUYÉ (C.), *Guide de la Convention de Berne pour la protection des œuvres littéraires et artistiques (Acte de Paris, 1971)*, Genève, OMPI, 1978.

REINBOTHE (J.) and VON LEWINSKI (S.), *The WIPO Treaties 1996. The WIPO Copyright Treaty and The WIPO Performances and Phonograms Treaty. Commentary and Legal Analysis*, London, Butterworths, 2002.

REPROBEL, *Public lending right*, 9<sup>th</sup> International PLR Conference, 22-24 September 2011, Brussels, [www.reprobel.be/fr/reprobel-en-quelques-mots/reprobel/licences-legales/leenrecht/conference-internationale-sur-le-pret-public.html](http://www.reprobel.be/fr/reprobel-en-quelques-mots/reprobel/licences-legales/leenrecht/conference-internationale-sur-le-pret-public.html).

RICKETSON (S.) and GINSBURG (J. C.), *International Copyright and Neighboring Rights. The Berne Convention and Beyond*, vol. I and II, 2<sup>nd</sup> ed., Oxford, Oxford University Press, 2006.

SENFTLEBEN (M.), *Copyright Limitations and the three-step test*, Kluwer Law International, 2004.

VON LEWINSKI (S.) and WALTER (M. M.), *European Copyright Law, A commentary*, Oxford, Oxford University Press, 2010.

## Articles

ALIX (Y.), "Les exceptions bénéficiant aux bibliothèques, la révolution ?", *R.L.D.I.*, 2007, supplément au n° 25, p. 25-28.

ALLEAUME (CH.), "Le droit de prêt public (en France et au-delà)", *Propr. intell.*, 2004, n° 12, p. p. 718-737.

ALLEAUME (CH.), "Les exceptions de pédagogie et de recherche", *Comm. Com. élect.*, 2006, n° 11, p. 13-17.

ALTAMURA (D. M.), "Archivi online e diritto d'autore: sfruttamento economico abusive di fotografie", note under Trib. Torino 23 maggio 2012, *D.I.I.*, 2012, p. 950-959.

APLIN (T.), "United Kingdom", in B. Lindner and T. Shapiro (ed.), *Copyright in the information society: a guide to national implementation of the European Directive*, Cheltenham, Edward Elgar, 2011, p. 558-577.

AXHAMN (J.) and GUIBAULT (L.), *Cross-border extended collective licensing: a solution to online dissemination of Europe's cultural heritage?*, Final report for EuropeanaConnect, Amsterdam, 2011, [www.ivir.nl/staff/guibault.html](http://www.ivir.nl/staff/guibault.html).

AZZI (T.), "La loi du 1<sup>er</sup> août 2006 relative au droit d'auteur et aux droits voisins dans la société de l'information, ou le monopole préservé", *Comm. Com. élect.*, 2007, n° 7-8, p. 7-12.

BECHTOLD (S.), "Directive 2001/29/EC (InfoSoc Directive) of the European Parliament and of the Council of 22 May 2001 on the harmonisation of certain aspects of copyright and related rights in the information society", in Th. Dreier and B. Hugenholtz (ed.), *Concise European Copyright Law*, Alphen aan den Rijn, Kluwer Law International, 2006, p. 343-403.

BENABOU (V.-L.), "La directive droit d'auteur, droits voisins et société de l'information : valse à trois temps avec l'acquis communautaire", *Comm. Com. élec.*, 2001, n° 10, p. 8-11.

BENABOU (V.-L.), "La directive "société de l'information" et l'acquis communautaire : une anamorphose ?", *Propr. intell.*, 2002, n° 2, p. 58-65.

BENABOU (V.-L.), "L'exception au droit d'auteur pour l'enseignement et la recherche ou la recherche d'une conciliation entre l'accès à la connaissance et le droit d'auteur", in Noyer (J.-M.), *Programme de Numérisation pour l'Enseignement et la Recherche (PNER). Synthèse des travaux : Janvier 1999 – Septembre 2002*, Paris, Maison des Sciences de l'Homme, 2002, 262 p.

BENABOU (V.-L.), "Retour sur dix ans de jurisprudence de la Cour de justice de l'Union européenne en matière de propriété littéraire et artistique : les méthodes", *Propr. intell.*, n° 43, April 2012.

BERGUIG (M.), "Propriété intellectuelle : les tablettes : révolution des usages, (r)évolution des droits de propriété intellectuelle ? Introduction : Les tablettes numériques d'un point de vue pratique et juridique", *R.L.D.I.*, 2011, n° 71, p. 82-84.

BONNET (V.), "Adapter le droit d'auteur à l'environnement numérique. Le rôle des associations de bibliothèques et d'EBLIDA", *Cahiers de la documentation – Bladen voor documentatie*, 2012, n° 4, p. 49-55.

BRISON (F.), "Het gebruik van auteursrechtelijk beschermde werken in digitale leerplatformen", *A.M.*, 2004, n° 1, p. 20-24.

BRUGUIÈRE (J.-M.) and FAUCHOUX (V.), "Le livre numérique. Quel statut juridique ?", *R.L.D.I.*, 2011, n° 73, p. 84-94.

BUYDENS (M.) and DUSOLLIER (S.), "Les exceptions au droit d'auteur dans l'environnement numérique : évolutions dangereuses", *Comm. Com. élec.*, 2001, n° 9, p. 10-16.

BUYDENS (M.), "La nouvelle directive du 22 mai 2001 sur l'harmonisation de certains aspects du droit d'auteur et des droits voisins dans la société de l'information : le régime des exceptions", *A.M.*, 2001, n° 4, p. 429-444.

CARON (CH.), "Les exceptions. L'impact sur le droit français", *Propr. intell.*, 2002, n° 2, p. 25-30.

CARON (CH.), "Ce que dit la loi sur les livres indisponibles", *Comm. Com. électr.*, 2012, n° 11, p. 26-28.

CARRE (S.), Le rôle de la Cour de Justice dans la construction du droit d'auteur de l'Union, in C. GEIGER (ed.), *La contribution de la jurisprudence à la construction de la propriété intellectuelle en Europe*, Collection du CEIPI, LexisNexis, 2013, p. 1-58.

CARRE-PIERRAT (O.), "La numérisation des livres indisponibles", *Comm. Com. électr.*, 2012, n° 1, p. 3.

CARRIÉ (S.), "Les bibliothèques à l'heure du numérique", *Comm. Com. électr.*, 2006, n° 6, p. 13-16.

CASTEX (L.), "Encadrer une bibliothèque numérique : de sa constitution à son exploitation", *R.L.D.I.*, 2010, n° 66, p. 84-92.

CHRISTIE (A. F.), *Cultural Institutions, Digitisation and Copyright Reform?*, Legal Studies Research Paper n° 303, University of Melbourne, 2007, <http://ssrn.com/abstract=1081733>, 15 p.

COHEN JEHORAM (H.), "Auteursrecht vooral van onderen belicht. Kroniek van het auteursrecht in Nederland 2003-2006", *A.M.*, 2006, n° 4, p. 318-325.

COMTE (H.), "A step towards a copyright Europe: the EEC directive of 19 November 1992 on lending and rental", *R.I.D.A.*, 1993, n° 158, p. 2-73.

CORASANITI (G.), "Diritti d'autore e prospettiva sociale: quali opportunità per le biblioteche", *D.I.I.*, 2008, p. 129-139.

CORBET (J.), "La transposition en droit belge de la directive droit d'auteur dans la société de l'information", *R.I.D.A.*, 2005, n° 206, p. 5-67.

CORBET (J.), "Chronique de Belgique", *R.I.D.A.*, 2009, n° 219, p. 102-191.

CORBETT (S.) and BODDINGTON (M.), "Copyright Law and the Digitisation of Cultural Heritage", Centre for Accounting, Governance & Taxation Research Working Paper No. 77, 2011, <http://ssrn.com/abstract=1806809>, 19 p.

CORBETT (S.), *Archiving Our Culture in a Digital Environment: Copyright Law and Digitisation Practices in Cultural Heritage Institutions*, 2011, <http://ssrn.com/abstract=2040977>, 48 p.

CORNU (M.), "L'accès aux archives et le droit d'auteur", *R.I.D.A.*, 2003, n° 195, p. 3-107.

CREWS (K.), "Distance Education and Copyright Law: The Limits and Meaning of Copyright Policy", *J.C. & U.L.*, vol. 27, 2000, n° 1, p. 15-51.

DEGROOTE (F.), "Directive sur l'harmonisation de certains aspects du droit d'auteur et des droits voisins dans la société de l'information : à la recherche d'un équilibre des droits", *Cah. Dr. Inf.*, 2001, n° 136, p. 1-6.

DELGADO (A.), "The implementation of Directive 2001/29 in Spanish intellectual property law (author's rights and related rights)", *R.I.D.A.*, 2006, n° 210, p. 4-51.

DELGADO (A.), "Cronica de España", *R.I.D.A.*, 2008, n° 216, p. 182-319.

DERCLAYE (E.), "La transposition de la directive "droit d'auteur dans la société de l'information" au Royaume-Uni. Quelques aspects relatifs aux droits et aux exceptions", *Prop. intell.*, 2004, n° 11, p. 599-606.

DERCLAYE (E.), "Of Maps, Crown Copyright, Research and the Environment", *E.I.P.R.*, 2008, n° 4, p. 162-164.

DERIEUX (E.), "Le livre à l'ère numérique. Questions juridiques sans réponses", *R.L.D.I.*, 2010, n° 60, p. 80-103.

DERIEUX (E.), "Le régime juridique de l'exploitation numérique des livres indisponibles du XX<sup>e</sup> siècle. Cheval de Troie de Google ? Loi n° 2012-287 du 1<sup>er</sup> mars 2012 (Code de la propriété intellectuelle, articles L. 134-1 à L.134-9)", *R.L.D.I.*, 2012, n° 87, p. 64-72.

DESURMONT (TH.), "La Communauté européenne, les droits d'auteurs et la société de l'information", *R.I.D.A.*, 2001, n° 190, p. 2-69.

DOHERTY (M.) and GRIFFITHS (I.), "The Harmonisation of European Union Copyright Law for the Digital Age", *E.I.P.R.*, 2000, n° 1, p. 17-23.

DREIER (TH.), "La transposition de la directive sur le droit d'auteur et les droits voisins dans la société de l'information. La situation en Allemagne. Etats des lieux", *Prop. intell.*, 2005, n° 15, p. 124-128.

DREIER (T.), "Musées, bibliothèques et archives : de la nécessité d'élargir les exceptions au droit d'auteur", *Prop. intell.*, 2012, n° 43, p. 185-192.

DUSOLLIER (S.), "Droit d'auteur et bibliothèques dans l'univers numériques", *Rev. Ubiquité*, 2002, n° 12, p. 79-89.

DUSOLLIER (S.), "Exceptions and Technological Measures in the European Copyright Directive of 2001", *I.I.C.*, 2003, vol. 34, p. 62-83.

DUSOLLIER (S.), "La contractualisation de l'utilisation des œuvres et l'expérience belge des exceptions impératives", *Prop. intell.*, 2007, n° 25, p. 443-452.

DUSOLLIER (S.), "Pruning the European intellectual property tree: in search of common principles and roots", in Ch. Geiger (ed.), *Constructing European intellectual property: achievements and new perspectives*, Cheltenham, Elgar, 2013, p. 24-57.

DZIOMDZIORA (W. Z.), "Poland", in B. Lindner and T. Shapiro (ed.), *Copyright in the information society: a guide to national implementation of the European Directive*, Cheltenham, Edward Elgar, 2011, p. 426-438.

FABIANI (M.), "La transposition en Italie de la directive 2001/29/CE", *R.I.D.A.*, 2004, n° 202, p. 127-137.

FABIANI (M.), "Chronique d'Italie", *R.I.D.A.*, 2007, n° 212, p. 112-147.



FICSOR (M.), "Hungary", in B. Lindner and T. Shapiro (ed.), *Copyright in the information society: a guide to national implementation of the European Directive*, Cheltenham, Edward Elgar, 2011, p. 251-275.

GAUBIAC (Y.), "Les exceptions. La méthode suivie et les résultats obtenus", *Propr. intell.*, 2002, n° 2, p. 17-24.

GAUBIAC (Y.), "Droit d'auteur et intérêt général", *Propr. intell.*, 2010, n° 36, p. 814-822.

GAUTIER (P.-Y.), "L'élargissement des exceptions aux droits exclusifs, contrebalancé par le "test des trois étapes"", *Comm. Com. électr.*, 2006, n° 11, p. 9-13.

GEIGER (CH.), "Les exceptions au droit d'auteur à des fins d'enseignement et de recherché en droit allemand", *Propr. intell.*, 2002, n° 5, p. 29-39.

GEIGER (CH.), "La loi du 1<sup>er</sup> août 2006, une adaptation du droit d'auteur aux besoins de la société de l'information ?", *R.L.D.I.*, 2007, n° 25, p. 67-77.

GEIGER (CH.), MACREZ (F.), BOUVEL (A.), CARRE (S.), HASSLER (TH.) and SCHMIDT (J.), "Quelles limites au droit d'auteur dans la société de l'information ? Réponse au Livre vert sur "le droit d'auteur dans l'économie de la connaissance", *Propr. intell.*, 2009, n° 32, p. 231-244.

GERVAIS (D. J.), "Making Copyright Whole: A Principled Approach to Copyright Exceptions and Limitations", *U.O.L.T.J.*, 2008, vol. 5, n° 1-2, <http://ssrn.com/abstract=182534>, <http://www.uoltj.ca/publish.php?iid=7>, p. 1-41.

GINSBURG (J. C.), "'European Copyright Code" – Back to first principles (with some additional detail)", *A.M.*, 2011, n° 1, p. 5-21.

GRANCHET (A.), "Enseignement et droit d'auteur", *Comm. Com. électr.*, 2005, n° 12, p. 21-24.

GRAZIADEI (F.), RIZZO (G.) and STAZI (A.), "Reti e contenuti nella prospettiva della convergenza: scenari ed opzioni aperte dallo sviluppo del digitale", *D.I.I.*, 2005, p. 539-570.

GUIBAULT (L.), "The nature and scope of limitations and exceptions to copyright and neighbouring rights with regard to general interest missions for the transmission of knowledge: prospects for their adaptation to the digital environment", *Copyright Bulletin*, 2003, [http://portal.unesco.org/culture/en/files/17316/10874797751l\\_guibault\\_en.pdf/l\\_guibault\\_en.pdf](http://portal.unesco.org/culture/en/files/17316/10874797751l_guibault_en.pdf/l_guibault_en.pdf), 45 p.

GUIBAULT (L.), Why cherry-picking never leads to harmonization, *JIPITEC*, 2010/1, p. 62.

HART (M.) and HOLMES (S.), "Implementation of the Copyright Directive in the United Kingdom", *E.I.P.R.*, 2004, n° 6, p. 254-257.

HART (M.), "The Copyright in the InfoSoc Directive: An Overview", *E.I.P.R.*, 2002, n° 2, p. 58-64.

HILTY (R. M.), "La transposition de la directive sur le droit d'auteur et les droits voisins dans la société de l'information. Allemagne. Analyse critique et prospective", *Propr. intell.*, 2005, n° 15, p. 140-145.

HILTY (R.), "Copyright law and scientific research", in P. Torremans (ed.), *Copyright Law, A Handbook of Contemporary Research*, Cheltenham, Edward Elgar, 2007, p. 315-354.

HOEREN (TH.), "Urheberrecht 2000 – Thesen für eine Reform des Urheberrechts", *MMR*, 2000, n° 1, p. 3-7.

HUGENHOLTZ (B.) and SENFTLEBEN (M. R.F.), *Fair Use in Europe. In Search of Flexibilities*, Amsterdam, 2011, <http://www.ivir.nl/publications/hughenoltz/Fair%20Use%20Report%20PUB.pdf>, 30 p.

HUGENHOLTZ (B.), "The Implementation of the Directive 2001/29/EC in the Netherlands", *R.I.D.A.*, 2005, n° 206, p. 116-147.

HUGENHOLTZ (B.), "Directive 96/9/EC on the legal protection of databases", in Th. Dreier and B. Hugenholtz (ed.), *Concise European Copyright Law*, Alphen aan den Rijn, Kluwer Law International, 2006, p. 307-342.

IGLESIAS (M.-J.) and VILCHES ARMAS (L.), "Les bibliothèques numériques et le droit d'auteur en Europe", *Cahiers prop. intel.*, 2007, vol. 19, n° 3, p. 937-987.

IGLESIAS (M.-J.), "Digital Libraries: any step forward?", *A.M.*, 2008, n° 5, p. 345-363.

IFLA, *IFLA Principles for Library eLending*, August 2013, [www.ifla.org/node/7418](http://www.ifla.org/node/7418), 3 p.

IFLA, *Les fondements du prêt de livres électroniques (E-books)*, 2012, [www.ifla.org/news/ifla-releases-background-paper-on-e-lending](http://www.ifla.org/news/ifla-releases-background-paper-on-e-lending), 12 p.

JANSSENS (M.-CH.), "De uitzonderingen op het auteursrecht anno 2005 – Een eerste analyse", *A.M.*, 2005, n° 6, p. 482-511.

JANSSENS (M.-CH.), "The issue of exceptions: reshaping the keys to the gates in the territory of literary, musical and artistic creation", in E. Derclay (ed.), *Research handbook on the future of EU copyright*, Cheltenham, Edward Elgar Publishing, 2009, p. 317-348.

JANSSENS (M.-CH.), "Commentaar bij artt. 21, 22, 22bis en 23bis Auteurswet", in *La loi belge sur le droit d'auteur. Commentaire par article. Hommage à Jan Corbet*, 3<sup>e</sup> éd., Bruxelles, Larcier, 2012, p. 135-190.

KINGSTON (W.), "Why Harmonisation is a Trojan Horse", *E.I.P.R.*, 2004, n° 10, p. 447-460.

KRIKKE (J.), "Council Directive 92/100/EEC (Rental and Lending Right Directive) of 19 November 1992 on rental right and lending right and on certain rights related to copyright in the field of intellectual property", in Th. Dreier and B. Hugenholtz (ed.), *Concise European Copyright Law*, Alphen aan den Rijn, Kluwer Law International, 2006, p. 239-262.

KROEZE (A.), "Auteursrecht in de informatiemaatschappij: Bouwstenen voor een justitiestrategie of luchtkastelen op drijfzand? Reactie op het rapport van het Ministerie van Justitie", *A.M.I.*, 2002, n° 4, p. 118-120.

KUNAL (K.), *Limitations and Exceptions Under Copyright Law in Relation to Libraries and Archives: International Developments and Impact on Developing Countries*, 2011, <http://ssrn.com/abstract=1967448>, 15 p.

LAPORTE-LEGEAIS (M.-E.), *Le droit de prêt dans le cadre des bibliothèques d'enseignement et de recherche*, 2001, <http://edutice.archives-ouvertes.fr/edutice-00000342>, 30 p.

LAURENT (PH.), "Les nouvelles exceptions au droit d'auteur en faveur de l'enseignement: l'ère de l'e-learning", *A.M.*, 2008, n° 3, [www.crid.be/pdf/public/5858.pdf](http://www.crid.be/pdf/public/5858.pdf), p. 180-193.

LEBOIS (A.), "Les exceptions à des fins de recherche et d'enseignement, la consécration ?", *Comm. Com. électr.*, 2007, n° 3, p. 18-24.

LLOYD (I.), "Intellectual Property in the Information Age", *E.I.P.R.*, 2001, n° 6, p. 290-295.

LONGDIN (L.), "Collaborative Authorship of Distance Learning Materials: Cross-border Copyright and Moral Rights Problems", *E.I.P.R.*, 2005, n° 1, p. 4-10.

LUCAS (A.), "La loi française du 1<sup>er</sup> août 2006 transposant la directive sur la société de l'information", *A.M.*, 2007, n° 1-2, p. 54-68.

LUCAS-SCHLOETTER (A.), "Lettre d'Allemagne. Qu'y a-t-il dans la "deuxième corbeille" ? La loi allemande du 26 octobre 2007 relative au droit d'auteur dans la société de l'information", *Propr. intell.*, 2008, n° 28, p. 368-375.

LUCAS-SCHLOETTER (A.), "Lettre d'Allemagne. Droit d'auteur", *Propr. intell.*, 2012, n° 45, p. 485-493.

MADELEINE (S.), "Propriété intellectuelle : les tablettes : révolution des usages, (r)évolution des droits de propriété intellectuelle ? Quel modèle pour l'édition numérique", *R.L.D.I.*, 2011, n° 71, p. 84-85.

MANHAEVE (K.) and SCHILTZ (TH.), "Luxembourg", in B. Lindner and T. Shapiro (ed.), *Copyright in the information society: a guide to national implementation of the European Directive*, Cheltenham, Edward Elgar, 2011, p. 358-383.

MAZUMDER (A.), "Information, Copyright and the Future", *E.I.P.R.*, 2007, n° 5, p. 180-186.

MAZZIOTTI (G.), "Tecnologie digitali e diritti culturali: quale ruolo per le biblioteche?", in A. Maggipinto and G. D'Amassa (ed.), *Diritto e tecnologie digitali per la valorizzazione e l'accessibilità delle conoscenze*, Atti del Convegno 19-20 ottobre 2007, Nyberg, Milano, 2009, p. 81-89.

MAZZIOTTI (G.), *Copyright and Educational Uses: the Unbearable Case of Italian Law from a European and Comparative Perspective*, EUI Working Paper (LAW), 2011/17, <http://cadmus.eui.eu/handle/1814/19697>, 31 p.

MEZEI (P.), *Hungary, National Report on the Balance of Copyright*, 2011, <http://ssrn.com/abstract=1904915>, 26 p.

MIGUEL (T. M.), "Exchanging Books in Western Europe: A Brief History of International Interlibrary Loan", *Intl. J. Leg. Info.*, vol. 35, n° 3, 2007, <http://ssrn.com/abstract=1345542>, p. 499-513.

MOERMAN (F.), "Leenrecht", *A.M.*, 2003, n° 6, p. 421.

NEUEN (J.), "La transposition en droit luxembourgeois de la directive européenne du 22 mai 2001 sur l'harmonisation de certains aspects du droit d'auteur et des droits voisins dans la société de l'information", *R.I.D.A.*, 2004, n° 204, p. 138-183.

NGOMBE (L. Y.), "Droit naturel, droit d'auteur français et copyright américain. Rétrospective et prospective", *R.I.D.A.*, 2002, n° 194, p. 2-123.

O'BRIEN (D.), GASSER (U.) and PALFREY JR. (J. G.), *E-books in Libraries : A Briefing Document Developed in Preparation for a Workshop on E-lending in Libraries*, Berkman Center Research Publication, n° 2012-15, 2012, <http://ssrn.com/abstract=2111396>, 29 p.

PIKE (G. H.), "First Sale Doctrine Put to the Test", *Information Today*, vol. 24, n° 9, 2007, [www.infoday.com/IT/oct07/index.shtml](http://www.infoday.com/IT/oct07/index.shtml), p. 17-19.

POLLAUD-DULIAN (F.), "Les droits exclusifs consacrés par la directive", *Propr. intell.*, 2002, n° 2, p. 7-16.

PRINS (C.) and SCHELLEKENS (M.), "Virtual Libraries: The Influence of Database Legislation on their New roles", *EDI L.R.*, 2000, n° 7, p. 217-222.

REICHMAN (J. H.) and OKEDIJI (R. L.), "When Copyright Law and Science Collide: Empowering Digitally Integrated Research Methods on a Global Scale", 2012, *Minn. L. Rev.*, vol. 96, p. 1362-1480.

RIIS (TH.) and SCHOVSBO (J.), "Extended Collective Licenses in Action", *I.I.C.*, vol. 43, 2012, p. 930-950.

ROBIN (A.), "Université numérique et créations immatérielles : l'enseignement en mode e-learning", *Propr. intell.*, 2010, n° 36, p. 833-844.

ROSENTHAL KWALL (R.), "Commentary: Library Reproduction Rights for Preservation and Replacement in the Digital Era: An Author's Perspective on § 108", *Colum. J.L. & Arts*, 2006, vol. 29, n° 3, p. 343-360.

SCHAEFER (M.), "Germany", in B. Lindner and T. Shapiro (ed.), *Copyright in the information society: a guide to national implementation of the European Directive*, Cheltenham, Edward Elgar, 2011, p. 216-232.

SCHØNNING (P.), "Implementation of the directive on copyright in the information society: Denmark", *R.I.D.A.*, 2004, n° 202, p. 81-105.

SEVILLE (C.), "The United Kingdom's Implementation of the Copyright Directive", *R.I.D.A.*, n° 202, p. 185-221.

SIRINELLI (P.), "La transposition de la directive sur le droit d'auteur et les droits voisins dans la société de l'information. La situation en France. Etat des lieux", *Propr. intell.*, 2005, n° 15, p. 129-135.

STRATTON (B.), *Le rapport Gowers sur la révision des règles de propriété intellectuelle. Etendre le champ des exceptions au Copyright au Royaume-Uni*, 2008, <http://archive.ifla.org/IV/ifla74/papers/161-Stratton-fr.pdf>, 7 p.

SYNDICAT NATIONAL DE L'ÉDITION and CENTRE FRANÇAIS D'EXPLOITATION DU DROIT DE COPIE, "L'exception pédagogique prévue par la loi DADVSI sera-t-elle réellement applicable au 1<sup>er</sup> janvier 2009 ?", *Légipresse*, 2008, n° 257, p. 49-50.

TEES (T.), *Ereaders in Academic Libraries*, 2010, <http://ssrn.com/abstract=1779462>, 13 p.

THE WITTEM GROUP, "European Copyright Code", *E.I.P.R.*, 2011, n° 2, p. 76-82.

TORREMANS (P.), "De recente hervormingen in het auteursrecht in het Verenigd Koninkrijk", *A.M.*, 2006, n° 1, p. 37-46.

TORREMANS (P.), "Archiving exceptions : where are we and where do we need to go ?", in E. Derclaye (ed.), *Copyright and Cultural Heritage, Preservation and access to works in a digital world*, Cheltenham, Edward Elgar, 2010, p. 111-128.

TRIAILLE (J.-P.), "La directive sur le droit d'auteur du 22 mai 2001 et l'acquis communautaire", *A.M.*, 2002, n° 1, p. 8-13.

VALLÉE (Y.), BEIGNIER (B.), HEUSSE (M.-D.), MAGNAUDET-BARTHE (A.), and TRICOIRE (E.), "Les universités et le droit d'auteur: quels droits? quels débiteurs? quels bénéficiaires?", *D.*, 2006, n° 10, p. 668-669

VAN DER PERRE (K.), "Reprografie digitale onderwijsuitzondering, privé-kopie en leenrecht na de Wet van 22 mei 2005: standpunt van de auteurs", *A.M.*, 2005, n° 6, p. 520-531.

VIRIYO (A.), *Exception to Copyright Infringement for Study and Research : Comparative Study of Thailand and Australia*, 2012, <http://ssrn.com/abstract=2133132>, 11 p.

VISSER (D. J. G.), "De beperkingen in de Auteursrechtlijn", *A.M.I.*, 2001, n° 1, p. 9-15.

VIVANT (M.), "La transposition de la directive sur le droit d'auteur et les droits voisins dans la société de l'information. France. Analyse critique et prospective", *Propr. intell.*, 2005, n° 15, p. 146-153.

VON LEWINSKI (S.), "The Implementation of the InfoSoc Directive into German Law", *R.I.D.A.*, 2004, n° 202, p. 10-41.

VON LEWINSKI (S.), "News from Germany. Developments in Germany from Mid-2005 until the End of 2010. Part I", *R.I.D.A.*, 2011, n° 228, p. 164-285.

VON LEWINSKI (S.), "Recent Developments of German Author's Rights Law", *A.M.*, 2011, n° 2, p. 162-178.

WITHERSPOON (K.), "Copyright Issues Facing Galleries and Museums", *E.I.P.R.*, 2003, n° 1, p. 34-39.

XALABARDER (R.), "On-line teaching and copyright : any hopes for an EU harmonized playground ?", in P. Torremans (ed.), *Copyright Law, A Handbook of Contemporary Research*, Cheltenham, Edward Elgar, 2007, p. 373-401.

ZENO-ZENCOVICH (V.) and MEZZANOTTE (F.), "Le reti della conoscenza: dall'economia al diritto", *D.I.I.*, 2008, p. 141-171.

ZENO-ZENCOVICH (V.) and SANDICCHI (G. B.), "L'economia della conoscenza ed i suoi riflessi giuridici", *D.I.I.*, 2002, p. 971-1003.

## Reports & legislative documents

### International reports

CREWS (K.), *Study on Copyright Limitations and Exceptions for Libraries and Archives*, WIPO, August 2008, [www.wipo.int/meetings/en/doc\\_details.jsp?doc\\_id=109192/](http://www.wipo.int/meetings/en/doc_details.jsp?doc_id=109192/), 434 p.

RICKETSON (S.), *The WIPO Study on Limitations and Exceptions of Copyright and Related Rights in the Digital Environment*, 2003, available at docs/mdocs/copyright/en/sccr\_9/sccr\_9\_7.pdf

XALABARDER (R.), *Study on Copyright Limitations and Exceptions for Educational Activities in North America, Europe, Caucasus, Central Asia and Israel*, WIPO, November 2009, [www.wipo.int/meetings/en/doc\\_details.jsp?doc\\_id=130393/](http://www.wipo.int/meetings/en/doc_details.jsp?doc_id=130393/), 214 p.

### European Union

COMITÉ DES SAGES, THE NEW RENAISSANCE, REPORT OF THE REFLECTION GROUP ON BRINGING EUROPE'S CULTURAL HERITAGE ONLINE, 2011, [HTTP://EC.EUROPA.EU/INFORMATION\\_SOCIETY/ACTIVITIES/DIGITAL\\_LIBRARIES/DOC/REFGROUP/FINAL\\_REPORT\\_T\\_CDS.PDF](http://ec.europa.eu/information_society/activities/digital_libraries/doc/refgroup/final_report_t_cds.pdf), 44 P.

HIGH LEVEL EXPERT GROUP ON DIGITAL LIBRARIES, *Digital Libraries: Recommendations and Challenges for the Future*, i2010 Digital Libraries Initiative. Final report, 2009, [http://ec.europa.eu/information\\_society/activities/digital\\_libraries/doc/hleg/reports/hlg\\_final\\_report09.pdf](http://ec.europa.eu/information_society/activities/digital_libraries/doc/hleg/reports/hlg_final_report09.pdf), 17 p.

GUIBAULT (L.), WESTKAMP (G.), RIEBER-MOHN (T.), HUGENHOLTZ (P.B.), (et al.), *Study on the Implementation and Effect in Member States' Laws of Directive 2001/29/EC on the Harmonisation of Certain Aspects of Copyright and Related Rights in the Information Society*, report to the European Commission, DG Internal Market, February 2007, [www.ivir.nl/files/implementation\\_2001\\_29\\_EC/index\\_eng.html](http://www.ivir.nl/files/implementation_2001_29_EC/index_eng.html).

HUGENHOLTZ (B.), VAN EECHOUD (M.), VAN GOMPEL (S.), GUIBAULT (L.), HELBERGER (N.), ROSSINI (M.), STEIJGER (L.), DUFFT (N.) and BOHN (PH.), *The Recasting of Copyright & Related Rights for the Knowledge Economy*, 2006, [http://ec.europa.eu/internal\\_market/copyright/studies/](http://ec.europa.eu/internal_market/copyright/studies/).

### National reports

#### ▪ Belgium

CONSEIL DE LA PROPRIÉTÉ INTELLECTUELLE, *Avis : Pistes de réflexion relatives aux "bibliothèques numériques" dans trois cas de figure*, 2009,

[http://p://economie.fgov.be/fr/binaries/Biblioth%C3%A8ques%20Num%C3%A9riques\\_tcm326-77732.pdf](http://p://economie.fgov.be/fr/binaries/Biblioth%C3%A8ques%20Num%C3%A9riques_tcm326-77732.pdf).

#### ▪ France

HAUTE AUTORITÉ POUR LA DIFFUSION DES ŒUVRES ET LA PROTECTION DES DROITS SUR INTERNET, *Chantier exception au droit d'auteur et aux droits voisins. Synthèse des contributions reçues*, [www.hadopi.fr/actualites/actualites/chantier-exceptions-au-droit-d-auteur-et-aux-droits-voisins](http://www.hadopi.fr/actualites/actualites/chantier-exceptions-au-droit-d-auteur-et-aux-droits-voisins).

IDATE CONSULTING, *Etude sur l'offre commerciale de livres numériques à destination des bibliothèques de lecture publique*, Study elaborated for the French Ministry of Culture and Communication, Final Report, 2013, [www.culturecommunication.gouv.fr/Disciplines-et-secteurs/Livre-et-lecture/Actualites/Etude-IDATE-sur-les-livres-numeriques-en-bibliotheque](http://www.culturecommunication.gouv.fr/Disciplines-et-secteurs/Livre-et-lecture/Actualites/Etude-IDATE-sur-les-livres-numeriques-en-bibliotheque).

ISAAC (H.), *L'université numérique*, Rapport à Madame Valérie Préresse, Ministre de l'Enseignement Supérieur et de la Recherche, 2007, [www.enseignementsup-recherche.gouv.fr/cid20761/remise-du-rapport-universite-numerique-d-henri-isaac.html](http://www.enseignementsup-recherche.gouv.fr/cid20761/remise-du-rapport-universite-numerique-d-henri-isaac.html).

LESCURE (P.), *Mission « Acte II de l'exception culturelle », Contribution aux politiques culturelles à l'ère numérique*, 2013, [www.culturecommunication.gouv.fr/Actualites/Missions-et-rapports/Rapport-de-la-Mission-Acte-II-de-l-exception-culturelle-Contribution-aux-politiques-culturelles-a-l-ere-numerique](http://www.culturecommunication.gouv.fr/Actualites/Missions-et-rapports/Rapport-de-la-Mission-Acte-II-de-l-exception-culturelle-Contribution-aux-politiques-culturelles-a-l-ere-numerique).

STASSE (F.), *Rapport au ministre de la culture et de la communication sur l'accès aux œuvres numériques conservées par les bibliothèques publiques*, 2005, [www.ladocumentationfrancaise.fr/rapports-publics/054000450/index.shtml](http://www.ladocumentationfrancaise.fr/rapports-publics/054000450/index.shtml).

#### ▪ The Netherlands

VAN DER NOLL (R.), BREEMEN (K.), BREEMEN (V.), HUGENHOLTZ (B.), BROM (M.) and POORT (J.), *Online uitlenen van e-books door bibliotheken. Verkenning juridische mogelijkheden en economische effecten*, in opdracht van het Ministerie van Onderwijs, Cultuur en Wetenschap, Amsterdam, 2012, [www.rijksoverheid.nl/documenten-en-publicaties/rapporten/2012/11/01/online-uitlenen-van-e-books-door-bibliotheken.html](http://www.rijksoverheid.nl/documenten-en-publicaties/rapporten/2012/11/01/online-uitlenen-van-e-books-door-bibliotheken.html), [www.ivir.nl/publicaties/poort/Online\\_uitlenen\\_van\\_e-books.pdf](http://www.ivir.nl/publicaties/poort/Online_uitlenen_van_e-books.pdf).

#### ▪ United Kingdom

DEPARTMENT FOR CULTURE, MEDIA & SPORT, *Government Response to the Independent Review of E-Lending in Public Libraries in England*, 2013, [www.gov.uk/government/publications/an-independent-review-of-e-lending-in-public-libraries-in-england](http://www.gov.uk/government/publications/an-independent-review-of-e-lending-in-public-libraries-in-england).

GOWERS (A.), *Gowers Review of Intellectual Property*, Crown, December 2006, [www.hm-treasury.gov.uk/gowers/](http://www.hm-treasury.gov.uk/gowers/).

HARGREAVES (I.), *Digital Opportunity – A Review of Intellectual Property and Growth*, 2011, [www.ipo.gov.uk/ipreview-finalreport.pdf](http://www.ipo.gov.uk/ipreview-finalreport.pdf).

SIEGHART (W.), *An independent Review of E-Lending in Public Libraries in England*, 2013, [www.gov.uk/government/publications/an-independent-review-of-e-lending-in-public-libraries-in-england](http://www.gov.uk/government/publications/an-independent-review-of-e-lending-in-public-libraries-in-england).

- **United States**

THE LIBRARY OF CONGRESS NATIONAL DIGITAL INFORMATION INFRASTRUCTURE AND PRESERVATION PROGRAM e.a., *International Study on the Impact of Copyright Law on Digital Preservation*, 2008, [www.digitalpreservation.gov/documents/digital\\_preservation\\_final\\_report2008.pdf](http://www.digitalpreservation.gov/documents/digital_preservation_final_report2008.pdf).

THE SECTION 108 STUDY GROUP, *Executive Summary*, Section 108 Study Group Report, 2008, [www.section108.gov/docs/Sec108ExecSum.pdf](http://www.section108.gov/docs/Sec108ExecSum.pdf), 14 p.

THE SECTION 108 STUDY GROUP, *Report*, An Independent Report sponsored by the United States Copyright Office and the National Digital Information Infrastructure and Preservation Program of the Library of Congress, 2008, [www.section108.gov/docs/Sec108StudyGroupReport.pdf](http://www.section108.gov/docs/Sec108StudyGroupReport.pdf), 212 p.

U.S. COPYRIGHT OFFICE, « Revising Section 108: Copyright Exceptions for Libraries and Archives », 15 November 2012, [www.copyright.gov/docs/section108/index.html](http://www.copyright.gov/docs/section108/index.html)



**DE WOLF & PARTNERS**

## **Uses for the benefit of people with a disability**

By Sari DEPREEUW (PhD), De Wolf & Partners

With the assistance of Kirsten VAN GOSSUM and Jean-Benoît HUBIN, De Wolf & Partners

and under the supervision of Jean-Paul TRIAILLE, Partner, De Wolf & Partners, Lecturer, University of Namur





## Introduction

In this Study we will remind the Terms of Reference of the Study on the Application of Directive 2001/29/EC on Copyright and Related Rights in the Information Society (the "InfoSoc Directive") (*sub I*), then briefly describe the exception for uses for the benefit of people with a disability (*sub II*), examine the national implementation of this exception in the national copyright legislations of the Member States under consideration (Germany, France, UK, Italy, Spain, Poland, Denmark, Hungary and Benelux) (*sub III*), identify the bottlenecks in terms of cross-border accessibility (*sub IV*) and finally examine some solutions to those bottlenecks (*sub V*). Excerpts from the national copyright acts are added in an annex.

The research for this Study has been conducted until June 2013.

### I. Terms of Reference

Article 5(3) (b) of the InfoSoc Directive allows Member States to opt for a limitation in favour of uses for the benefit of people with disabilities. The use must be non-commercial and related directly to the disability.

This provision has been implemented in all the Member States in many different ways.

Some Member States have transposed the provision of the Directive word-for-word allowing a broad implementation (e.g. the Netherlands). Others have attached very strict conditions (in addition to the application of the 3-step test) to the application of this exception (e.g. France) and certain have even limited it to only one handicap (e.g. the UK has limited to visually impaired people). Some provide for remuneration to the right holders, others do not. Some Member States make a distinction between the persons who are entitled to perform the restricted acts and the end-beneficiaries of the exempted use. Furthermore, it is not entirely clear from national provisions whether the exception is addressed to legal (organisations or entities) or rather to physical persons.

The result of this variety of implementations is that even the definitions of handicap are not consensual among the Member States.

**Output 5:** The Study should assess not so much the variations in the definition of beneficiaries but rather the uses permitted and whether technological changes would warrant some update of the exception in particular as far as its cross border application is concerned (e.g. for the visually impaired).

### II. The exception for disabled people in the InfoSoc Directive

The Information Society Directive provides an exception to the harmonised exclusive rights (reproduction, communication to the public<sup>1209</sup> "making available" and distribution) in favour of disabled persons (art. 5(3) (b) of the InfoSoc Directive<sup>1209</sup>). Such exception is indeed necessary to avoid copyright infringements: many acts by principle restricted under copyright are required in order to make regularly published work

---

<sup>1209</sup> Directive 2001/29/EC of the European Parliament and of the Council of 22 May 2001 on the harmonisation of certain aspects of copyright and related rights in the information society, *Official Journal L 167*, 22/06/2001 P. 0010 – 0019..

accessible to people with various needs related to a disability. Often the format of the work should be adapted (sound v. print) or its expression will be altered (e.g. Braille for the visually impaired). These initiatives may imply acts of reproduction or adaptation (the right of adaptation is not harmonised under the InfoSoc Directive). Furthermore, individuals with disabilities may have access to works in adapted formats thanks to dedicated organisations, which produce and distribute the works. These undertakings may result in acts of distribution or communication to the public, both harmonised in the InfoSoc Directive.

Any initiative to make a work accessible to people with disabilities may thus involve restricted acts of reproduction, communication, making available or distribution to the public. In addition to these harmonised rights, the right of adaptation established under national copyright laws may be affected too. This means that, by principle, the prior consent of the author (or related right holder) should be acquired – unless an exception covers this use in the national copyright law.

The Member States are allowed to include such exception in their national laws, to the extent that the outer limits set by the Information Society Directive are not exceeded. These are expressed in art. 5(3) InfoSoc Dir:

*Member States may provide for exceptions or limitations to the rights provided for in Articles 2 and 3 in the following cases:*

*(b) uses, for the benefit of people with a disability, which are directly related to the disability and of a non-commercial nature, to the extent required by the specific disability;*

In addition, “where the Member States may provide for an exception or limitation to the right of reproduction pursuant to paragraphs 2 and 3, they may provide similarly for an exception or limitation to the right of distribution as referred to in Article 4 to the extent justified by the purpose of the authorised act of reproduction” (art. 5(4) InfoSoc Dir).

Although this exception is optional (rec. 34 InfoSoc Dir), it was considered “in any case important for the Member States to adopt all necessary measures to facilitate access to works by persons suffering from a disability which constitutes an obstacle to the use of the works themselves, and to pay particular attention to accessible formats” (rec. 43 InfoSoc Dir).

The InfoSoc Directive did not aspire to control all modalities or conditions of the exception. As explained in the comments to the articles in the initial proposal, it was considered that the Directive should give a margin for exceptions, which are “not specifically addressed in the multilateral conventions, but which are known in a large number of Member States, such as exemptions to the benefit of certain categories of people (persons with disabilities) or for use of works for purposes of administrative or judicial procedures or for the purpose of public security. In view of their more limited economic importance, these limitations are deliberately not dealt with in detail in the framework of this proposal. It only sets out minimum conditions of their application, and it is for the Member State to define the detailed conditions of their use, albeit within the limits set out by these paragraphs and this Article”<sup>1210</sup>. Apart from a modification of the beneficiaries (*infra*), the wording of the exception is identical to the first proposal of the Commission. It can be derived that little controversy existed among Member States regarding this limitation.

**Conditions.** The InfoSoc Directive allows national exceptions within the conditions of art. 5(3).

**Works and other protected subject matter.** The exception is not restricted to a particular type of works or subject matter protected under neighbouring rights. The Directive does not object to restricting the

---

<sup>1210</sup> Proposal for a European Parliament and Council Directive on the harmonisation of certain aspects of copyright and related rights in the Information Society, COM(97) 628 final, 97/0359 (COD), hereafter “Proposal InfoSoc Directive”, Comments on the articles, 32.

exclusive rights for all kinds of works, such as literary works, musical works and performances, cinematographic works and first fixations of films,...

**Use.** The exceptions may apply to all uses, i.e. acts of reproduction or communication to the public (art. 2 and 3 InfoSoc Dir). In case the Member States make an exception to the reproduction right, they are free to provide the same exception to the distribution right (art. 5(4) InfoSoc Dir)<sup>1211</sup>.

**Beneficiaries.** The use is meant to benefit people with a disability. The original proposal of 1997 provided a more limited group of beneficiaries, i.e. the “*visually-impaired or hearing impaired persons*”. The scope of application was enlarged in the 1999 Amended Proposal<sup>1212</sup>. This is in conformity with art. 26 of the Charter of Fundamental rights of the European Union in favour of the integration of persons with disabilities. The exempted acts may be performed by individuals with a disability or by other persons, for their benefit<sup>1213</sup>.

**Restrictions.** The permitted use should be directly related to the disability and should not exceed the use required by the specific disability. According to Von Lewinski and Walter this condition can be assessed by reference to the existing market offer. If there is an offer of works and/or other protected subject matter accessible to people with a disability (e.g. a “talking book”), then more initiatives can only be exempted under this exception to the extent that they propose an additional value to people with a disability, i.e. features that are not present in the already existing offer of accessible copies (e.g. when only an abridged version is available in an accessible form, arguably a complete version in accessible form has added value; similarly a version with scientific references in accessible form may still be a use required by a specific disability if the existing offer consists of versions without such references)<sup>1214</sup>.

Uses of a commercial nature are excluded. Publishers that pursue an economic advantage or a profit from the distribution of e.g. a book in Braille format cannot benefit from the exception<sup>1215</sup>.

Exceptions in the national copyright laws should be in conformity with the three-step test. A Member State may impose an obligation to pay a fair compensation in order to meet the three-step test (art. 5(5) InfoSoc Dir).

For clarity's sake, it should be noted that other exceptions may be relevant for people with a disability, especially the exceptions for private use (art. 5(2)(b) InfoSoc Dir). The exceptions in favour of memory institutions, for teaching or research may benefit to people with a disability and have been studied elsewhere.

Other factors may influence the overall situation of people with a disability. In particular, licensing schemes and assistive technologies could contribute a lot to improve access to works. We will not analyse these issues but they should be borne in mind when considering a legislative initiative on the exception in favour of people with a disability.

---

<sup>1211</sup> SULLIVAN assumed in her 2006 report that, under the Berne Convention, the exceptions to the reproduction right may implicitly be extended to the distribution right. J. SULLIVAN, “Study on copyright limitations and exceptions for the visually impaired”, WIPO Standing Committee on Copyright and Related Rights, 15th session, Geneva, September 11 to 13, 2006, [www.wipo.org](http://www.wipo.org), 18. Unlike the Berne Convention, the Information Society does harmonise the distribution right in art. 4. The exceptions may apply to this right in accordance with art. 5(4) InfoSoc Dir.

<sup>1212</sup> Amended proposal for a European Parliament and Council Directive on the harmonisation of certain aspects of copyright and related rights in the Information Society, COM/99/0250 final – COD 97/0359.

<sup>1213</sup> S. VON LEWINSKI & M.M. WALTER, “Information Society Directive” in M.M. WALTER & S. VON LEWINSKI (ed), *European Copyright Law*, Oxford, University Press, 2010, nr. 11.5.52.

<sup>1214</sup> S. VON LEWINSKI & M.M. WALTER, “Information Society Directive”, nr. 11.5.53.

<sup>1215</sup> S. VON LEWINSKI & M.M. WALTER, “Information Society Directive”, nr. 11.5.52.

### III. National implementation in the countries under consideration

In this part we will examine how the exception regarding the use to the benefit of people with a disability has been implemented in the national copyright legislation. We will compare the national provisions regarding this exception. We have found no court decisions and very little scholarly literature. This description will allow us to describe more accurately the legal bottlenecks (in part IV).

#### A. Works and other protected subject matter

The national copyright acts of most Member States under consideration allow all types of works to be used in the context of the exception to the benefit of disabled people, but various additional conditions apply. The exception also applies to other subject matter.

In some Member States under consideration, the exception is applicable to all types of works or protected subject matter (Belgium<sup>1216</sup>, France<sup>1217</sup>, Hungary<sup>1218</sup>, Italy<sup>1219</sup>, Luxemburg<sup>1220</sup>, The Netherlands<sup>1221</sup>). In other Member States, the exception can only apply to “published works” (Denmark<sup>1221</sup>, Poland<sup>1222</sup>, Spain<sup>1223</sup>).

The exception may be formulated in general terms to apply to all works but set out a particular regime for particular types of works. In Denmark, the exception applies to all published works, except for sound recordings of published literary works<sup>1224</sup>. The use and distribution for use of these sound recordings is permitted if it is done by visually impaired persons or backward readers and if a remuneration is paid to the author. The Hungarian copyright act provides a similar restriction.

Some Member States restrict the scope of the exception to the effect that it can only apply in case of a market failure (criterion of “commercial availability”). Germany thus allows the exempted use for works (including cinematographic works) that are not available in a perceivable form yet or if the forms in which they are available are not suited for the individually intended purpose<sup>1225</sup>. The UK provides a similar restriction<sup>1226</sup>.

The UK explicitly lists the works to which the exception applies: a literary, dramatic, musical or artistic work or a published edition, which is not accessible to the visually impaired person<sup>1227</sup>. Restrictions apply with regard to musical works and databases<sup>1228</sup>.

---

<sup>1216</sup> Articles 22 § 1, 11° and 46, 10° Belgian Copyright Act. The Belgian act makes the application of any exception dependent on the “legitimate divulgation” of the work.

<sup>1217</sup> Articles L. 122-5, L. 331-5 to L. 331-21 of the French Intellectual Property Code. On condition that the work has been “disclosed” (“*divulguée*”).

<sup>1218</sup> Art. 41(1) Hungarian Copyright Act.

<sup>1219</sup> Art. 71bis Italian Copyright Act.

<sup>1220</sup> Art. 10(11) Luxemburgish Copyright Act.

<sup>1221</sup> Art. 17 Danish Copyright Act.

<sup>1222</sup> Art. 33.1 Polish Copyright Act.

<sup>1223</sup> Art. 31.3 Spanish Copyright Act.

<sup>1224</sup> Art. 17(3) Danish Copyright Act.

<sup>1225</sup> Art. 45a German Copyright Act. M. LEISTNER, A. KOOF, M. KLEINEMENKE & S. KOROCH, National report Germany, *ALAI Congress Dublin*, 2011, <http://www.alaidublin2011.org/wp-content/uploads/2011/04/Germany.pdf>, 15.

<sup>1226</sup> Art. 31A(3) UK Copyright Act.

<sup>1227</sup> Art. 31A(1) UK Copyright Act.

<sup>1228</sup> Art. 31A(2) UK Copyright Act :

(2) Subsection (1) does not apply

## B. Restricted acts

In some cases, works or other subject matter are available in a form that is equally accessible to people with a disability as to others. A visually impaired person can enjoy a musical performance in the same way a person without reduced visual perception: it is not necessary to adapt it to her specific needs. But this is not always the case: in order to access “print works”, the work should be expressed in another format, adapted to the visually impaired person who wants to enjoy (read or hear) it. A hearing impaired person will enjoy a television show or a film to a fuller extent if the conversations are subtitled and the events are reflected in closed captioning.

The process of making a work accessible to persons with disabilities requires mostly (technical) adaptations, reproductions, performances or communications, acts of making available and distributions (in case the technical conversion is done by another person or organisation). These operations may thus be qualified as acts protected under copyright. Member States exempt those restricted acts to an unequal extent.

The Information Society Directive allows this exception for the rights of reproduction and communication to the public (including the making available right). It cannot be assumed that the exception to the reproduction right implicitly extends to the distribution right (although is often considered an incidental prerogative to the reproduction right<sup>1229</sup>), but the InfoSoc Directive allows Member States to provide for an exception to the distribution right where the reproduction right is restricted in accordance with art. 5(2) and (3), “to the extent justified by the purpose of the authorised act of reproduction” (art. 5(4) InfoSoc Dir).

Some Member States do not specify the type of use allowed under this exemption.

The Belgian copyright act allows acts of reproduction and communication to the public including the making available right, as do the French, Italian, Luxemburgish, Dutch, Polish and Spanish copyright acts. Hungary exempts all uses under this exception, including the reproduction and distribution of the work.

The Danish act allows the “use” (read: reproduction) and “distribution” of *copies* of the work, except in relation to sound recordings of literary works or use that consists solely of sound recordings of musical works. Certain government, social or non-profit actors are allowed to “produce copies” by means of sound or visual recording of works broadcast on the radio or television, for the use of visually handicapped and hearing-impaired persons (subject to the extended collective licensing provisions)<sup>1230</sup>. The Danish exception does not exempt acts of communication to the public.

Under German law, the works may be reproduced and distributed but not communicated to the public<sup>1231</sup>. The British copyright act similarly allows the making of accessible copies, the transfer of accessible copies to a visually impaired person or to a person “*who has lawful possession of the master copy and intends to transfer the accessible copy to a [visually impaired] person*”<sup>1232</sup>. Subsequent “dealings” outside

---

(a) if the master copy is of a musical work, or part of a musical work, and the making of an accessible copy would involve recording a performance of the work or part of it; or

(b) if the master copy is of a database, or part of a database, and the making of an accessible copy would infringe copyright in the database.

<sup>1229</sup> SULLIVAN, “Study on copyright limitations and exceptions for the visually impaired”, 18.

<sup>1230</sup> Art. 17 (4) Danish Copyright Act.

<sup>1231</sup> M. LEISTNER e.a., National report Germany, ALAI Congress Dublin, 16.

<sup>1232</sup> Art. 31A(7) UK Copyright Act.

the scope of these conditions are considered infringements, i.e. if the accessible copy is “sold or let for hire or offered or exposed for sale or hire or included in a broadcast or cable programme service”<sup>1233</sup>.

### C. Beneficiaries

The InfoSoc Directive mentions as the beneficiaries of this exception people with a “disability”, without narrowing down on the kind of disability the beneficiary should suffer or on the intensity of the disability. The exception is not restricted to physical handicaps so arguably people with other types of disabilities (cognitive, mental) could rely on it too. Also, the Directive does not specify who is allowed to perform the restricted acts under this exception: should the person with the disability herself be making the copies and the adaptations, is a third person allowed to do it on her behalf or even a (non-profit) organisation (whose activities benefit to a group of people with a disability)?

Some Member States have taken over the open notion of the Directive (Belgium, Germany, Hungary, Italy<sup>1234</sup>, Luxemburg, The Netherlands, Poland and Spain).

The French law contains specifications in two respects: the person who is entitled to perform the restricted acts and the end-beneficiary of the exempted use. The end-beneficiaries are people with a motorial, physical, sensorial, mental, cognitive and/or psychological disability. Moreover, the disability should amount to or exceed the rate to be determined by the “*Conseil d’Etat*” and be recognized by a specialised commission or a medical certificate<sup>1235</sup>. The law itself does not restrict the scope of application in function of the type of handicap, but in practice the provisions are mostly applied in favour of visually impaired people<sup>1236</sup>. The reproduction or communication to the public should be carried out by legal entities and institutions open to the public, such as libraries, archives, documentation centres or cultural multimedia centres. These entities have to prove that they have an actual professional activity of conceiving, producing and communicating supports in favour of people suffering from the mentioned disabilities and justify it by reference to their formal purpose, their members or users, the material and human resources and the services they offer<sup>1237</sup>.

Other Member States have defined particular types of disabilities.

Denmark grants exceptions in favour of people with particular disabilities, in function of the subject matter to be used. The exempted use of published works is reserved to the blind, visually impaired, the deaf and sufferers from speech impediments, as well as persons who on account of handicap are unable to read printed text<sup>1238</sup>. The use of sound recordings of published literary works is permitted in favour of visually impaired persons and backward readers<sup>1239</sup> and works broadcast on the radio or television may be used in favour of visually handicapped and hearing-impaired persons<sup>1240</sup>. The Danish law does not specify whether the person with a disability should perform the restricted act or if another entity can do it on her

<sup>1233</sup> Art. 31A(10) UK Copyright Act.

<sup>1234</sup> Art. 71bis of the Italian copyright act however provides that a ministerial decree may clarify the categories of disabilities, the criteria to determine which individuals may benefit from the exception and the conditions of use.

<sup>1235</sup> Art. L-122-5, 7° French code de la propriété intellectuelle : (...) “dont le niveau d’incapacité est égal ou supérieur à un taux fixé par décret en Conseil d’Etat, et reconnues par la commission départementale de l’éducation spécialisée, la commission technique d’orientation et de reclassement professionnel ou la commission des droits et de l’autonomie des personnes handicapées mentionnée à l’article [L. 146-9](#) du code de l’action sociale et des familles, ou reconnues par certificat médical comme empêchées de lire après correction”.

<sup>1236</sup> G. VERCKEN & L.-M. ARMANET, National report France, *ALAI conference Dublin*, 2011, 12.

<sup>1237</sup> P. LESCURE, Culture Acte 2, Mission « Acte II de l’exception culturelle », Contributions aux politiques culturelles à l’ère numérique, 441-446, [http://www.culturecommunication.gouv.fr/var/culture/storage/culture\\_mag/rapport\\_lescore/index.htm#1](http://www.culturecommunication.gouv.fr/var/culture/storage/culture_mag/rapport_lescore/index.htm#1)

<sup>1238</sup> Art. 17 (1) Danish Copyright Act.

<sup>1239</sup> Art. 17 (3) Danish Copyright Act.

<sup>1240</sup> Art. 17 (4) Danish Copyright Act.

behalf, except for works broadcast on the radio or television, which only government or municipal institutions and other social or non-profit institutions may use<sup>1241</sup>.

In the UK, the exception is reserved to visually impaired persons<sup>1242</sup>. It covers use by the visually impaired person or by a third person on her behalf. The law also contains a definition of a visually impaired person, i.e. a person who (a) is blind, (b) has an impairment of visual functions which cannot be improved by the use of corrective lenses to a level that would normally be acceptable for reading without a special level or kind of light, or (c) who is unable, through physical disability to hold or manipulate a book, or (d) who is unable through physical disability to focus or move his (or her) eyes to the extent that would normally be acceptable for reading<sup>1243</sup>. Another section allows the provision of sub-titled copies of a broadcast, by a “designated body” and in favour of people who are deaf or hard of hearing, or physically or mentally handicapped in other ways<sup>1244</sup>. The designated body is defined as a “*body designated for the purposes of this section by order of the Secretary of State, who shall not designate a body unless he is satisfied that it is not established or conducted for profit*”<sup>1245</sup>.

#### D. Purpose and additional conditions/restrictions

The Information Society Directive allows a large exception for the benefit of people with disabilities in terms of subject-matter, restricted acts and beneficiaries, but it draws the outer limits of the exempted use in qualitative terms. A use is permitted provided that (i) it is directly related to the disability, (ii) to the extent required by the specific disability and (iii) of a non-commercial nature.

All Member States impose these conditions in some form or other.

The Hungarian copyright act rephrases the three conditions and exempts any non-commercial use if the purpose of the use is to meet demands of disabled persons that are directly related to their disability and if it does not exceed the extent justified by the purpose<sup>1246</sup>. Similarly the Italian copyright act does not impose any additional conditions<sup>1247</sup>, neither does the Dutch Act<sup>1248</sup>.

The Belgian law takes over the conditions of the Directive and explicitly adds the two last steps of the three-step test (absence of a conflict with the normal exploitation of the work and of an unreasonable prejudice to the legitimate interests of the right holders)<sup>1249</sup>. The Luxemburgish exception is worded in a similar way<sup>1250</sup>, as is the Polish exception<sup>1251</sup>.

The German law allows the reproduction of a work for non-commercial purposes if such reproduction is necessary to facilitate access. It also allows the distribution exclusively to the person with the disability. It is implied that the available means to access the work should be assessed *in concreto*: the reproduction and distribution of a work are exempted to the extent that the readily available means of sensual

---

<sup>1241</sup> Art. 17 (4) Danish Copyright Act.

<sup>1242</sup> This exception is under review in the UK : see “Technical review of draft legislation on copyright exceptions. Disability exceptions”, UK IPO, 31 July 2013, accessible via <http://www.ipo.gov.uk/techreview-disability-exceptions.pdf>.

<sup>1243</sup> S. 31F(9) UK Copyright Act.

<sup>1244</sup> S. 74(1) UK Copyright Act.

<sup>1245</sup> S. 74(2) UK Copyright Act.

<sup>1246</sup> Art. 41(1) Hungarian Copyright Act.

<sup>1247</sup> Art.71bis Italian Copyright Act.

<sup>1248</sup> Art. 15(i) Dutch Copyright Act.

<sup>1249</sup> Art. 22, § 1, 11° and 46, 10° Belgian Copyright Act.

<sup>1250</sup> Art. 10(11) Luxemburgish Copyright Act.

<sup>1251</sup> Art. 33 Polish Copyright Act.



perception fail to make the work accessible<sup>1252</sup>. As a general rule, the source must in all cases be clearly indicated<sup>1253</sup>. By principle, where the use of a work is permissible under the exception, no alterations to the work are allowed<sup>1254</sup>. However, some alterations are in any case required to make a work or other subject matter accessible to people with a disability. A strict application of this rule would therefore undermine the very exception in favour of people with a disability<sup>1255</sup>, so this rule is softened to the extent that it is permissible to make “[alterations] to the work and its title to which the author cannot refuse his consent based on the principles of good faith”<sup>1256</sup>. Arguably, the alterations necessary to make a work accessible to a person with a disability are modifications which an author cannot refuse based on the principles of good faith.

The Danish law contains a more detailed expression of these conditions. The use of the published works and sound recordings of published literary works must be (i) specifically intended for the end beneficiaries<sup>1257</sup> and (ii) restricted in the sense that the work may not be altered more extensively than is required for the permitted use<sup>1258</sup>. Copies of broadcast works may be produced by means of sound or visual recording on condition that the requirements concerning the extended collective licences are met and the recording is used for the purpose of activities covered by the extended collective agreement<sup>1259</sup>. In addition, the Danish Act requires that the source be mentioned in case of public use.

The French exception in favour of people with a disability repeats the condition that the use should be restricted to what is required by the (nature of the) specific disability and two steps of the three-step test (i.e. absence of a conflict with the normal exploitation of the work of any unreasonable prejudice to the legitimate interests of the right holders). In addition, the exception is explicitly restricted to the purpose of a strictly private consultation of the work by persons suffering a disability.

The Spanish exception requires in addition to the conditions in the Directive that the work be used “*through a media or procedure that is adapted to the corresponding disability*”<sup>1260</sup>.

Under the UK Act, only non-commercial use is allowed and it is specified that, if a sum is charged for the accessible copy, then it must not exceed the cost of making and supplying the copy<sup>1261</sup>. In addition, the visually impaired person is only entitled to use the work under this exception if she has lawful possession or lawful use of a copy, which is not accessible to her because of the impairment and if she makes an accessible copy of the master copy for her personal use. The market situation must be taken into account for the application of the exception in the sense that it does not apply if “*copies of the copyright work are commercially available, by or with the authority of the copyright owner, in a form that is*

<sup>1252</sup> Art. 45a(1) German Copyright Act.

<sup>1253</sup> Art. 63 German Copyright Act.

<sup>1254</sup> Art. 62 German Copyright Act.

<sup>1255</sup> It is provided that in principle no alterations to a work are allowed, where a use is tolerated under one of the exceptions. In the same provision, some modifications are allowed, in particular “*where necessitated on account of the purpose of the use, translations and such alterations to the work shall be permissible if they only constitute extracts or transpositions into another key or pitch*” (art. 63(2) German Copyright Act. The limitations in this provision (extracts or transpositions into another key or pitch) are not likely to allow an adaptation into a format accessible to a person with a disability. However, the same article refers to art. 39 of the act, which provides the holder of an exploitation right requires the author’s consent to make alterations to the work and that it shall be permissible to make alterations to the work and its title to which the author cannot refuse his consent based on the principles of good faith. *Mutatis mutandis* such alterations can also be made for the exercise of exceptions.

<sup>1256</sup> Art. 39(2) German Copyright Act.

<sup>1257</sup> Art. 17(1) Danish Copyright Act.

<sup>1258</sup> Art. 11 Danish Copyright Act.

<sup>1259</sup> Art. 17(4) Danish Copyright Act.

<sup>1260</sup> Art. 31bis(2) Spanish Copyright Act. See M. GARCIA-LEON, “Spain” in L. LIDNER & T. SHAPIRO (ed.), *Copyright In The Information Society*, E. Elgar Publishing, 2011, 523.

<sup>1261</sup> Art. 31A(5) UK Copyright Act.

*accessible to the individual who wishes to benefit from the exception*<sup>1262</sup>. Furthermore, the law excludes certain uses from this exception. Firstly, a visually impaired person cannot rely on this exception to make an “accessible copy” of a musical work (or part of it), if this would involve recording a performance of the work or part of it<sup>1263</sup>. It can be understood that a performance of a musical work is used in the same way by people with and without visual impairment. Finally, the accessible copy must be accompanied by a statement that it is made under the section providing the exception and by a sufficient acknowledgement<sup>1264</sup>.

The UK Act regulates the making of multiple copies for visually impaired persons in a separate section<sup>1265</sup>. The copying of a commercially published literary, dramatic, musical or artistic work or a commercially published edition is not an infringement if it is done by an “approved body”, under the same conditions *mutatis mutandis* as the making of a single accessible copy for personal use<sup>1266</sup>. An “approved body” is defined as “an educational establishment or a body that is not conducted for profit”<sup>1267</sup>. Third parties are thus allowed to make multiple copies to the benefit of individuals with an impairment, but additional conditions apply to ensure that the effects of this exception do not exceed what the legislator had in mind. Firstly, an education establishment, acting as an approved body, must ensure that the copies will be used only for its educational purposes<sup>1268</sup>. Secondly, if an approved body continues to hold an accessible copy (made this exception) when it would no longer be entitled to make or supply such a copy, the copy is to be treated as an infringing copy<sup>1269</sup>. Finally, copy protection must be applied to the copies made under this exception, if the master copy is in copy-protected electronic form<sup>1270</sup>. The subsequent distribution of a copy made under this exception may turn into an infringement<sup>1271</sup>.

**Compensation.** Some Member States foresee a payment to the right holders, to compensate them for the use exempted under this exception (regardless of the exception for private use). This is the case in Denmark (for sound recordings of published literary works and broadcast works<sup>1272</sup>), Germany (except for individual copies) and in The Netherlands. In Italy, no remuneration is due but this may be imposed by Ministerial Decree.

**Override by contract.** The question whether the exception can be overridden by contract has fairly little importance with regard to works in tangible copies: it is not very common for the right holder and the user to conclude a contract over the use of such object, e.g. a book or a DVD. The increasing access via electronic databases, however, has outlined this issue more clearly<sup>1273</sup>. Such exploitation of works gives right holders the opportunity to impose certain conditions regarding the use of protected works, thus accessed. Users are thus asked to waive the benefit of a legal exception by contract, upon which access to the work is conditional. Member States are tolerant to different degrees towards such practices, which increases the divergences between national copyright laws.

The Computer Programs Directive and the Databases Directive contain a specific provision (respectively art.8 and art.15) stressing the mandatory character of the limitations and exceptions listed in those

<sup>1262</sup> Art. 31A(3) UK Copyright Act.

<sup>1263</sup> Art. 31A(2)(a) UK Copyright Act.

<sup>1264</sup> Art. 31A(4) UK Copyright Act.

<sup>1265</sup> Art. 31B UK Copyright Act.

<sup>1266</sup> Art. 31A UK Copyright Act.

<sup>1267</sup> Art. 31B(12) UK Copyright Act.

<sup>1268</sup> Art. 31B(7) UK Copyright Act.

<sup>1269</sup> Art. 31B(9) UK Copyright Act.

<sup>1270</sup> Art. 31B(8) UK Copyright Act.

<sup>1271</sup> Art. 31B(10) UK Copyright Act.

<sup>1272</sup> Art. 13(3)-(4) Danish Copyright Act.

<sup>1273</sup> SULLIVAN, “Study on copyright limitations and exceptions for the visually impaired”, 44, par. 2.11.

directives. The InfoSoc Directive does not preclude that the right holders impose a prohibition for the user to use a work in conformity with an exception<sup>1274</sup>, including the exception in favour of people with a disability<sup>1275</sup>.

GUIBAULT reminds us that in a second reading of the Proposal for the InfoSoc Directive, an amendment was tabled for the introduction of an art. 5(6) dedicated to the imperative character of the limitations and exceptions<sup>1276</sup>. However, this amendment was rejected by the Commission. Consequently, the imperative or default character of the limitations has to be determined at the national level.

The Belgian Copyright Act declares the imperative character of exceptions, including the one under consideration<sup>1277</sup>. By principle, the application of the exceptions cannot be overridden by contract. However, an exception to this priority of the exceptions to contractual agreements is made for works made available on demand on agreed contractual terms. This means that any exception may be set aside with regard to works made available on demand<sup>1278</sup>.

In the UK, by contrast, it is permitted to restrict acts that are exempted under an exception<sup>1279</sup>.

For the other Member States under consideration, no provisions regarding the relationship between the exception and contracts have been found. This is a cause of uncertainty.

**Technological Protection Measures (TPMs).** Technical measures are legally protected under the Information Society Directive (art. 6). These may however conflict with uses exempted under art. 5 InfoSoc Directive. For example, an e-book on a tangible support may be protected by a TPM so it is technically not possible to make a digital copy, while such copy is commonly required to make a copy that is accessible to persons with a disability (e.g. a Braille version or an audio book). For this reason, the European legislator has obliged the Member States to safeguard the benefit of certain exceptions (in the absence of voluntary measures taken by right holders, including agreements between right holders and other parties concerned) (art. 6(4) InfoSoc Dir). Among these guaranteed exceptions is the provision to the benefit of people with a disability (art. 5(3)(b) InfoSoc Dir): Member States are thus required to take appropriate measures to ensure that right holders make available to the beneficiary of the national exception “*the means of benefiting from that exception or limitation, to the extent necessary to benefit from that exception or limitation and where that beneficiary has legal access to the protected work or subject-matter concerned*” (art. 6(4) InfoSoc Dir).

However, this guarantee does not apply when the works or other subject-matter are “*made available to the public on agreed contractual terms in such a way that members of the public may access them from a place and at a time individually chosen by them*”. This means that, in certain circumstances, when a work or other subject matter is made available on demand (in the sense of art. 3 InfoSoc Dir), the beneficiary of an exception cannot force the right holder to take the necessary measures so she can benefit from this exception. For example, when the e-book is not distributed on a DVD but via an online platform, the beneficiary could not rely on the safeguard in art. 6(4) InfoSoc Dir. This effect depends on the interpretation of the ambiguous phrase “*made available to the public on agreed contractual terms*”<sup>1280</sup>.

---

<sup>1274</sup> L. GUIBAULT, “Why Cherry-Picking Never Leads to Harmonisation: The Case of the Limitations on Copyright under Directive 2001/29/EC”, *JIPITEC*, 2010/2 (55) 59. S. DUSOLLIER, *Droit d’auteur et protection des oeuvres dans l’univers numérique*, Larcier, 2005, 502-503.

<sup>1275</sup> SULLIVAN, “Study on copyright limitations and exceptions for the visually impaired”, 44, par. 2.11. See also C. TAN, “Moving towards a more inclusive copyright regime for the visually impaired”, *SAC LJ* 2012/24 (433) 437.

<sup>1276</sup> GUIBAULT, “Why Cherry-Picking Never Leads to Harmonisation”, 59.

<sup>1277</sup> Art. 23bis Belgian Copyright Act.

<sup>1278</sup> Critical : DUSOLLIER, *Droit d’auteur et protection des oeuvres dans l’univers numérique*, 504.

<sup>1279</sup> Art. 28(1) UK Copyright Act.

<sup>1280</sup> DUSOLLIER explains how this phrase could reassure some right holders that the guarantee of these exceptions would not undermine their business model, e.g. by allowing access to a work despite the TPMs to make a private copy whereas the end-user

Where such “contractual terms” are “agreed upon” and the TPMs prevail over the exception, she would find herself subject to contractual negotiations with the right holder, who may grant or refuse a licence or impose other conditions such as the payment of a fee or territorial restrictions.

This regime is reflected in the Belgian, German, Hungarian and Luxemburgish Copyright Acts.

In Denmark, the Copyright License Tribunal may, upon request, order a right holder to make the necessary means available to a user, to the effect that she can benefit from the exception. If the right holder does not comply with the order within 4 weeks from the decision of the Tribunal, the user is entitled to circumvent the effective technological measure<sup>1281</sup>.

The French copyright provisions also contain a more detailed regime<sup>1282</sup>. A High Authority (“la Haute Autorité”) is established to regulate the interaction between DRMs and exceptions, with recourse to the courts if necessary. More specifically, the legal entity or establishment benefiting from the exception may address the High Authority with regard to any dispute relating to the transmission of printed texts in a digital format. Furthermore, the exception in favour of people with a disability provides that the recognised organisations, catering for the people with a disability, are entitled to request the digital file that was used for the publication of the work, which should then be transferred to a designated institution. This institution will then conserve this digital file and make it available to the recognised organisations in an open standard, while guaranteeing the confidential nature of the file and while securing access to the file<sup>1283</sup>.

In Italy, the right holders are obliged to adopt proper solutions, also by means of specific agreements with the associations representing beneficiaries, in order to allow the exercise of the exceptions on beneficiaries’ specific request. The condition is that the beneficiaries have lawful possession of the copies of the work or of the protected subject-matter or have lawfully accessed them. This provision does however not apply to works made available on demand on agreed contractual terms.

The Luxemburgish Act allows, in case of non-compliance by the right holder, the end beneficiaries or a group/ association representing their interests to launch an injunction procedure against the right holder in order to cease the application of the technical measures impeding the end beneficiary to profit/ benefit from the exception. In the Netherlands, compliance may be ensured by a government order.

In the UK, the benefit of the exception can be pursued by a complaint to the Secretary of State who can order the copyright owner to make available a means of carrying out the permitted acts. Failure to comply with the order may give rise to an action before the courts<sup>1284</sup>.

No specific provision was found in the Polish or Spanish Copyright Acts.

Overall there is uncertainty as to whether the technological protection measures actually form an obstacle to the acts allowed under the exception, to the detriment of the beneficiaries<sup>1285</sup>. Moreover, several States have provided that where the right holder does not take voluntary measures to allow the use of the work or other subject matter, the beneficiary can take legal action against the right holder. The courts

---

had only temporary access to the work (« rental »). Given the circumstance that many if not most works and other subject matter are made available on « agreed contractual terms » (e.g. standard terms and conditions), it could be derived that the guarantee for the exception can always be set aside for on demand content. See S. DUSOLLIER, *Droit d’auteur et protection des œuvres dans l’univers numérique*, 177.

<sup>1281</sup> I.S. NWANKWO, “Proposed WIPO Treaty for Improved Access for Blind, Visually Impaired, and other Reading Disabled Persons and its compatibility with TRIPS Three-Step Test and EU Copyright Law, *JIPITEC* 2011, (203) 212.

<sup>1282</sup> Article L. 331-5 to L. 331-21 of the French Intellectual Property Code.

<sup>1283</sup> Art. L122-5(7), par. 3-4 French Intellectual Property Code.

<sup>1284</sup> Article 296ZE of the UK Copyright Act.

<sup>1285</sup> TAN, “Moving towards a more inclusive copyright regime for the visually impaired”, 439,

can then impose measures that should allow the beneficiary to benefit from the exception. Given the high costs of court proceedings, the uncertain outcome and the possibly long duration of the litigation, it is uncertain how effective this judicial guarantee of the exception in favour of people with a disability is in practice<sup>1286</sup>.

## E. Conclusions

The exception in favour of people with a disability has been implemented in the copyright legislations of all Member States under consideration in this Study but the scope of application differs from one Member State to the other<sup>1287</sup>. The most important divergences exist on the exempted restricted acts (exclusive rights), the condition of “commercial (non)availability”, the beneficiaries (strict conditions) and additional conditions (such as remuneration rights).

## IV. Bottlenecks

The limitations to the exclusive rights in the InfoSoc Directive have been studied in the 2007 IViR report<sup>1288</sup>. The study found that the exception had been implemented in the copyright laws of all Member States but that diverging conditions of application had been set out and different addressees of the exception (individuals or organisations). It was concluded that “*these divergences in the national legislation are not likely to be conducive to the development of viable business models aimed at the production and distribution of digital content that can cater to the needs of the physically impaired, for neither the rights owners nor the beneficiaries know where they stand regarding the boundaries set by this limitation. The emphasis should be on the non-commercial nature of the activity – and on its compliance with the “three-step test” – rather than on the status of the person or entity carrying it out*”<sup>1289</sup>.

In the framework of the current Study, it is impossible to assess precisely to which extent the lack of complete harmonisation presents an actual problem. The accessibility of works to people with a disability can at least partially be achieved by means of appropriate licensing and (digital) technologies that assist the person with a disability<sup>1290</sup>. A complete overview of the legal and technical means available to overcome a certain disability exceeds the scope of the current Study. In the absence of this information, we cannot determine whether it is necessary or desirable to further modify (and if so, in due proportion) the exception in favour of people with a disability.

In this section we will examine the main bottlenecks in view of the priorities stated in the Terms of Reference (*supra*, *sub I*). We will analyse how the cross-border accessibility of the works is complicated for persons with a disability, given the differences in the national copyright provisions. A first bottleneck is found with regard to the cross-border distribution of tangible copies. A second bottleneck concerns the cross-border online access to works for people with a disability. Possible solutions will be examined in the final section (*sub V*).

---

<sup>1286</sup> NWANKWO, “Proposed WIPO Treaty for Improved Access for Blind, Visually Impaired, and other Reading Disabled Persons”, 211-212.

<sup>1287</sup> GUIBAULT, “Why Cherry-Picking Never Leads to Harmonisation”, 63.

<sup>1288</sup> Study on the implementation and effect in Member States’ laws of Directive 2001/29/EC on the harmonisation of certain aspects of copyright and related rights in the information society, IViR, Amsterdam, 2007, 39 et s (hereafter IViR Implementation Study).

<sup>1289</sup> *IViR Implementation Study*, 52.

<sup>1290</sup> We refer here to initiatives such as ETIN (*infra*) and TIGAR (Trusted Intermediary Global Accessible Resources), a project set up by the WIPO, seeking to “facilitate cross-border exchange of copyright protected electronic files for books in accessible formats between national libraries and charitable institutions (trusted intermediaries) serving the blind, visually impaired and other persons with print disabilities”. See <http://www.visionip.org/tiqar/en/>.

## A. Cross-border accessibility

An important question is whether the exception in favour of people with a disability in the Information Society Directive and in the national copyright laws allows sharing accessible versions of a work or other subject matter within the European Union.

The stakes are obvious: people with an interest in a particular work may be residing in several Member States (e.g. language groups spread over several countries) and want access to a work or other subject matter provided in another Member State. According to PAPADOPOULOU, “[how] the individual provisions on exceptions for the benefit of print disabled that have been found in national copyright laws might work when accessible copies move between different countries is very important matter for print disabled and those organizations assisting them”<sup>1291</sup>. The circumstance that an exception has only national effect has economic consequences to the extent that economies of scale are more difficult to achieve (cost/benefit per copy). The advantages could be important in large language groups, which count a proportionally large number of people with disabilities. Due to the territorial nature of copyright, legal obstacles may prevent interested parties from sharing copies or access to adapted works<sup>1292</sup>. A cross-border initiative may in some cases raise an issue of private international law, in other cases several national copyright laws will apply in a cumulative way.

Works and other subject matter can be distributed in a tangible form or in an intangible form. Depending on the form of distribution, different legal issues arise.

Tangible copies, such as texts in Braille format, produced in accordance with the copyright exception in one Member State, could be distributed and exported to other Member States where interest in these particular copies exists. The legal issue is then whether the **distribution right** forms an obstacle to the cross-border transportation of such copy. This issue will be analysed under section 1.

Intangible versions of an accessible work can be shared via information networks, such as the Internet. The legal issue in that case is whether the **right of communication to the public**, including the making available right<sup>1293</sup>, prevents that an accessible version of a work is shared among interested parties in several Member States. This will be analysed under section 2.

### 1. Distribution of tangible copies

**Material copies.** All examined copyright laws allow reproductions and the distribution of copies that are accessible to people with a disability; there seems to be no particular obstacle pertaining to the restricted acts necessary to produce and circulate accessible copies of a work. There may be differences between the national laws, but these differences entail no particular problems as long as the accessible copy is made and distributed on the national territory of one Member State.

Complications occur when people with a disability or their organisations want to share copies across the borders of Member States. In some cases, the national exceptions are subject to similar conditions<sup>1294</sup>.

---

<sup>1291</sup> M-D. PAPADOPOULOU, “Copyright exceptions and limitations for persons with print disabilities: the innovative Greek legal framework against the background of the international and European developments”, September 14, 2010). Available at SSRN: <http://ssrn.com/abstract=1874620> or <http://dx.doi.org/10.2139/ssrn.1874620>, 5.

<sup>1292</sup> PAPADOPOULOU, “Copyright exceptions and limitations for persons with print disabilities”, 6; GUIBAULT, “Why Cherry-Picking Never Leads to Harmonisation”, 63.

<sup>1293</sup> We will leave aside the issue of the different degree of harmonisation between copyright works and subject matter protected under neighbouring rights. Art. 3 of the Information Society Directive only harmonises the making available right for the related subject matter, not the general right of communication to the public. This issue has been addressed in the study *The Recasting of Copyright & Related Rights for the Knowledge Economy*, IViR, 2006, 61 et s.

<sup>1294</sup> For example, those national copyright acts that have essentially taken over the conditions of the Directive, e.g. Belgium and the Netherlands.

The question is then whether a copy in an accessible format, produced and circulated in accordance with the national exception of one Member State, can be transported to a beneficiary in another Member State, where the same exception (with the same conditions) applies. In other cases, important differences exist on the conditions that determine the scope of application of the exceptions: some Member States (such as the UK or France) impose detailed conditions thus reducing the scope of the exception, compared to less strict legislations. Furthermore, some Member States grant a remuneration to the right holder whose rights have been restricted by the exception.

For example, a blind organisation in Belgium produces Braille copies of a novel in French, which could be interesting not only to French speaking persons in Belgium but also to those in France or Luxemburg. The Luxemburgish law provides an exception under the same conditions as the Belgian law. The French law imposes strict criteria, in particular with regard to the person with the disability (visual impairment of a certain degree or medical certificate) and the organisation authorised to produce the accessible copies<sup>1295</sup>. These restrictions to the French exception could be circumvented or undermined by the import of accessible copies produced and circulated under the Belgian copyright act. Similarly, German language versions of the work could be produced under the Belgian exception, which does not grant a right to equitable remuneration, and brought to Germany, where such remuneration right does exist.

Right holders may wonder whether they can undertake any action against the arrival of accessible copies, produced under the more lenient exception of another Member State.

**Distribution right.** Firstly, it should be assessed whether the “export” of a copy to another Member State (resp. the “import” from another Member State) should be regarded as an act of distribution in the sense of art. 4 InfoSoc Directive. The Information Society Directive does not provide a specific importation right<sup>1296</sup>. However, the distribution right protects “acts which entail, and only acts which entail, a transfer of the ownership of that object”<sup>1297</sup> and the offer of such transfer of ownership<sup>1298</sup>. In *Donner*, the CJEU decided that the distribution to the public is “characterised by a series of acts going, at the very least, from the conclusion of a contract of sale to the performance thereof by delivery to a member of the public”<sup>1299</sup>. Whenever an (adapted) work is offered for sale, be it in another Member State, the right of distribution should be considered. This right being an exclusive right, those acts should either be authorised by the right holder or be covered by an exception or limitation. These acts could take place in several Member States (*Donner*, par. 26).

**Exhaustion.** The distribution right is restricted by the principle of exhaustion (art. 4(2) InfoSoc Dir). It could thus be examined whether a copy, legitimately produced and circulated in one Member State under an exception in its copyright legislation, can be brought to other Member States without the renewed consent of the right holder, by virtue of the principle of exhaustion<sup>1300</sup>. Following the exhaustion principle, the distribution right is consumed within the internal market and a “specific copy may be further distributed within the whole Community (EU/EEA) even if the right of distribution is held by other right holders in other Member States”<sup>1301</sup>. If this principle applied, then accessible copies legitimately produced and distributed in one Member State could be further distributed to beneficiaries in other Member States. This

---

<sup>1295</sup> See VERCKEN & ARMANET, National report France, *ALAI conference Dublin*, 2011, 16.

<sup>1296</sup> VON LEWINSKI & WALTER, “Information Society Directive”, 996.

<sup>1297</sup> CJEU 17 April 2008, case C-456/06, *Peek & Cloppenburg v Cassina*, par.36. Critical : VON LEWINSKI & WALTER, “Information Society Directive”, 994-995.

<sup>1298</sup> VON LEWINSKI & WALTER, “Information Society Directive”, 996, par. 11.4.14.

<sup>1299</sup> CJEU 21 June 2012, case C-5/11, criminal proceedings against Titus Donner, par. 26 (hereafter “Donner”).

<sup>1300</sup> See on this principle : VON LEWINSKI & WALTER, “Information Society Directive” 997 et s.

<sup>1301</sup> VON LEWINSKI & WALTER, “Information Society Directive” 1001..

exhaustion rule aims at reconciling copyright protection with the free movement of goods and can be read against the background of the CJEU's decisions in this field<sup>1302</sup>.

The principle of exhaustion is however subject to conditions, which are not likely to be met in the case under consideration. The right holder can no longer exercise her distribution right with respect to copies, where the first sale or other transfer of ownership in the Community of that object is made by her or with her consent (art. 4(2) InfoSoc Dir). The distribution right is exhausted if two conditions are fulfilled: (i) the original of a work or copies must have been placed on the market by the rightholder or with her consent and (ii) they must have been placed on the market in the Community (*Laserdisken*, par. 21)<sup>1303</sup>. The Directive makes the exhaustion of the distribution right explicitly conditional upon the consent of the right holder: only if the right holder has transferred the ownership of a particular copy (or this has been done with her consent), she is precluded from further exercising her distribution right.

This condition rules out that the distribution right be exhausted on grounds of an exception, when – by definition – the right holder has not authorised the reproduction or distribution of her work.

Moreover, it seems that the exceptions in art. 5 InfoSoc Directive cannot extend the scope of the exhaustion rule. The CJEU indicated in *Laserdisken* that the exceptions are independent of the exhaustion rule (in case regarding the *effect* of the limitations). Answering the question whether the Member States are free to restrict the distribution right by a principle of international exhaustion, the Court added in *Laserdisken* that the Information Society Directive does not grant such margin. The Court came to this conclusion based on the wording of art. 4(2) and recital 28 of the Directive. In addition, it found support in art. 5 of the InfoSoc Directive and it observed that “*nothing in that article indicates that the exceptions or limitations authorised might relate to the rule of exhaustion laid down in Article 4(2) of Directive 2001/29 and, therefore, allow Member States to derogate from that rule*” (*Laserdisken*, par. 25). None of the exceptions may thus be relied upon to extend the effect of the exhaustion rule and to restrict the right holders' control after an authorised first sale outside the European Union.

The pivotal position of the right holder's consent is confirmed, once more, in case the first sale of a copy takes place in a country where the exclusive rights of the copyright holder are not recognised. Such first sale does not lead to exhaustion of the distribution right, more generally “*this applies in any case when no consent is given*”<sup>1304,1305</sup>.

The conclusion is that the distribution right is not exhausted by the legitimate reproduction and distribution under the exception in favour of people with a disability in one Member State<sup>1306</sup>. When a copy in accessible format is transported to another Member State, it should be verified whether an act of distribution to the public can be found and where it takes place. By principle, the right holder is entitled to

---

<sup>1302</sup> See *inter alia* X., « Interface between exhaustion of intellectual property rights and competition law », WIPO Secretariat, CDIP/4/4 rev./Study/INF/2, 1 June 2011, accessed via [http://www.wipo.int/edocs/mdocs/mdocs/en/cdip\\_4/cdip\\_4\\_4rev\\_study\\_inf\\_2.pdf](http://www.wipo.int/edocs/mdocs/mdocs/en/cdip_4/cdip_4_4rev_study_inf_2.pdf), p. 17-22.

<sup>1303</sup> CJEU 12 September 2006, case C-479/04, *Laserdisken ApS v Kulturministeriet*, Reports of Cases 2006 I-08089 (hereafter “*Laserdisken*”).

<sup>1304</sup> VON LEWINSKI & WALTER, “Information Society Directive”, 1000. See also the opinion of Advocate General JÄÄSKINEN of 29 March 2012 in *Donner*, par. 59.

<sup>1305</sup> The CJEU has decided, in a case on the free movement of a medicinal product protected under national patent laws, that the production and distribution under a national compulsory licence does not lead to exhaustion : a right holder can still rely on the exclusive patent rights to oppose the importation and distribution of a product, protected under the national patent law of the Member State of importation, even if the product was lawfully produced and distributed under a compulsory licence in a Member State of exportation. See CJEU, case 19/84, 9 July 1985, *Pharmon v Hoechst*.

<sup>1306</sup> In this sense : SULLIVAN, *Study on copyright limitations and exceptions for the visually impaired*, 53 ; PAPAPOPOULOU, “Copyright exceptions and limitations for persons with print disabilities”, 7.



exercise her distribution right in the Member State of destination<sup>1307</sup>, unless an equivalent exception applies under the copyright law of that Member State.

**Disability exception.** If the cross-border circulation of legitimate accessible copies involves acts of distribution and if the exhaustion rule does not apply, then it should be verified where this act of distribution takes place and whether this act of distribution of an accessible copy (made in conformity with the law of another Member State) can be exempted under the applicable exception in favour of disabled persons. As PAPADOPOULOU rightly points out, “[*what*] provision is appropriate regarding distribution of accessible copies made abroad, where a country does not provide for international exhaustion of rights should be considered very carefully. It would be necessary, for instance, to decide to what extent a provision in copyright law should permit accessible copies made in another country to be circulated, even on a not-for-profit basis, and even where they benefit print disabled, but where there are no copies in normal circulation within the country”<sup>1308</sup>. In the Marrakesh Treaty, the issues of cross-border exchange and importation of accessible format copies have explicitly been dealt with (art. 5-6 Marrakesh Treaty). Such provisions are lacking the copyright *acquis communautaire*.

Based on the InfoSoc Directive, as interpreted by the CJEU, an answer to this question of cross-border transfer of accessible copies (within the EU) can be sought. Firstly, the making of a copy in an accessible format will entail acts of reproduction and, most likely, adaptation. These acts take place in one Member State and it should be verified whether the production of the accessible copy complies with the exception in favour of people with a disability there<sup>1309</sup>. When the accessible copy is circulated within the same Member State and beyond, it should be verified whether an act of distribution to the public takes place in another Member State.

The CJEU has stated in *Donner* that an act of distribution is performed in the Member State where the public is addressed via advertisement, where it has access to a specific delivery system and payment method and thus is enabled to receive delivery of copies of works protected by copyright in that same Member State (Donner, par. 30)<sup>1310</sup>. The national courts should examine whether the trader *targeted* the members of the public residing in the Member State where an act of “distribution to the public” was carried out (Donner, par. 28). If it is found that an act of distribution takes place in the Member State to which the accessible copy is transported, then it should be verified whether this act of distribution to the public is exempted under the national exception in favour of people with a disability.

**Effect.** This means that an organisation intending to distribute accessible copies in several Member States must abide by the copyright laws of all Member States where the public is targeted. It should verify whether its initiative meets the legal conditions of the national exceptions and, where it does, whether additional obligations arise (e.g. payment of a remuneration). Given the existing disparity between the national exceptions in favour of people with a disability, many impediments exist to the cross-border sharing of accessible format copies.

This will hardly affect the individual person with a disability, making an accessible copy for her own benefit or having another individual do this on her behalf. By contrast, organisations that work on a larger scale may be restricted in their functioning, especially if they have international ambitions.

---

<sup>1307</sup> See on “inbound regulations” (which protect a right holder from infringing behaviour originating in another country) and “outbound regulations” (extending national protection to countries with a lower or no IP protection) : A. PEUKERT, “Territoriality and Extraterritoriality in Intellectual Property Law” in G. HANDL & J. ZEKOLL (ed), *Beyond territoriality: transnational legal authority in an age of globalization*, Queen Mary Studies in International Law, Brill Academic Publishing, Leiden/Boston, 2011, available at SSRN: <http://ssrn.com/abstract=1592263>.

<sup>1308</sup> PAPADOPOULOU, “Copyright exceptions and limitations for persons with print disabilities”, 7-8.

<sup>1309</sup> It can be imagined that this is not the case, e.g. because the copy is excessive by reference to the reproduction or adaptation required by the specific disability. For example, the identical reproduction of an audio book cannot be justified under this exception by the argument that any audio book is helpful for the blind and visually impaired.

<sup>1310</sup> See also *Study on the territoriality of the making available right*, output 1 and 2 of part I of the study, II, C, 1.

For example, a blind organisation in Belgium produces Braille copies of a novel in French, which could be of interest to French-speakers in Belgium and in Luxembourg. The Belgian and Luxembourgish copyright acts provide an exception in similar terms<sup>1311</sup>. An accessible copy made in Belgium should meet the conditions of the exception under Belgian law, as should the distribution on the Belgian market. For the “export” of accessible copies to persons with a disability in Luxembourg, it should be verified which restricted acts take place in Belgium and/or in Luxembourg. The accessible copies are made in Belgium and should comply with the Belgian exception. The cross-border transfer of accessible copies can arguably be qualified as an act of distribution, taking place in Luxembourg. Consequently, it should be verified whether the act of distribution taking place in Luxembourg complies with the exception in favour of people with a disability in the Luxembourgish Copyright Act. It can be expected that this is the case, provided that the exception also limits the distribution right and that the copy meets the other conditions (the same as in the Belgian copyright act), i.e. it is directly related to disability, it has no commercial nature and it does not exceed the extent required for the disability at stake.

The same conclusion may be reached if the blind organisation in Belgium sends accessible copies of a work to beneficiaries in The Netherlands. It should then take into account however that compensation is due under the Dutch exception. Arguably, the Belgian organisation and/or the beneficiary have the obligation to pay this fee since the effects of the exception are indeed felt on Dutch territory<sup>1312</sup>.

It is even more complicated where an act of distribution is found in a Member State with more stringent conditions, such as France. The French exception in favour of people with a disability indeed requires that the person be recognised as a person with a disability and that the establishment or legal entity performing the restricted acts be on a list, composed by an administrative authority. Such conditions are more difficult to meet for organisations in other Member States.

A different level of protection (with stricter conditions in one Member State than in the other) may lead to the following scenarios<sup>1313</sup>:

- The organisation restricts its activity to the territory of the Member State where it is established;
  - No cross border activity is possible (e.g. because the organisation has not quality to act on behalf of a beneficiary of the exception in the Member State of destination);
  - Cross-border activity is possible provided that the more restrictive conditions are respected; the conditions may *de facto* lead to the abstention of the organisation (e.g. national formalities such as an administrative recognition of the organisation in France);
- The organisation offers its services in several Member States by abiding by the strictest exceptions among them.
  - If the strictest rules are respected, then the activity will meet the legal requirements in other Member States (*qui peut le plus peut le moins*) – supposing that no other contraction exists between the national exceptions.
  - The effect may be that in the Member States with more lenient conditions, the exception will be under-used, e.g. because a part of the beneficiaries is not served or because works are not made accessible in all forms permitted under that national law. Alternatively the organisations have to implement variable regimes depending on the national territory they are serving.

---

<sup>1311</sup> A work or other subject matter may be reproduced and distributed to the public provided that the copy is directly related to the disability and of a non-commercial nature and it does not exceed the extent required by the specific disability.

<sup>1312</sup> CJEU 16 June 2011, C-462/09, *Stichting De ThuisKopie v Opus Supplies Deutschland GmbH, Mijndert van der Lee, Hananja van der Lee*. See also A. PEUKERT, “Territoriality and Extraterritoriality in Intellectual Property Law”, 18. PEUKERT describes how German law subjects foreign libraries to a levy when they transmit copies via fax to users in Germany.

<sup>1313</sup> It should be verified in an economic study whether this is indeed the case.

**Summary.** Where tangible copies in accessible format circulate between the Member States, it must be verified whether an act of distribution takes place. If such copy has been produced and is distributed under the national exception in favour of people with a disability of one Member State, the distribution right is not exhausted (absent a transfer of ownership with the right holder's consent). In case of cross-border circulation, acts of distribution may take place in several Member States. It should then be examined for each act of distribution whether it meets the conditions of the exception in favour of people with a disability in the Member State where it takes place (cf. localisation criteria in *Donner*). Generally the cross-border transfer of a copy is not hampered if the exceptions in the Member State of production and in the Member State of destination cover the acts of reproduction (adaptation) and distribution to the public and if similar conditions apply. Where the Member State of destination provides a more restrictive exception, the distribution of the accessible copy is exempted only if it meets those stricter conditions (e.g. payment of a fee or a levy, beneficiaries or intermediaries subject to national recognition). This may make the distribution to the public in another Member State significantly more difficult in practice, or even impossible.

## 2. Access online

Our current digital environment offers more opportunities to access information, including protected works, across borders. Books, magazines and newspapers are for example offered in formats accessible to people with a visual impairment (talking books or in a mark-up language compatible with reading software).

For example, the Bibliothèque Numérique Francophone Accessible (BNFA) offers digital books in various formats<sup>1314</sup>: audio books and digital text books in an encrypted format (encrypted PDF or the Daisy standard, the decryption device permitting to verify whether the user is an actual beneficiary of the exception). BNFA offers its services in France and in Switzerland and it is mentioned on its website that the provisions of the French resp. Swiss Copyright Act should be complied with<sup>1315</sup>. Similarly, in the Netherlands, Dedicon makes a number of textual works available<sup>1316</sup> in spoken form or in XML, which can be read by means of an XML reader<sup>1317</sup>. It is mentioned that anyone with a reading disability can make an account (it is not mentioned that this possibility is restricted to people residing in The Netherlands).

Such services are not *per se* restricted to the territory of one country but could benefit to people residing in different Member States (e.g. expats and nationals abroad or people within the EU speaking the same language). This raises the question whether acts of reproduction, communication to the public or making available to the public are made and whether EU-wide services can be offered without acquiring the right holders' consent.

**Communication and making available to the public.** Any online service, offering works and other subject-matter in an accessible format, should be analysed in order to establish which restricted acts take place. It can be imagined that a work or other subject matter is reproduced and altered in order to adapt it to the needs of persons with a certain disability (reproduction and adaptation). An accessible copy may be made available online in the form of streaming or offered for download. Such online offer will entail acts of communication to the public and/or making available to the public. The end-user who consults the accessible copy will make a reproduction. In case of streaming this is most likely a temporary reproduction that may be exempted under the exception for temporary acts of reproduction (art. 5(1)

---

<sup>1314</sup> <http://www.bnfa.fr/>.

<sup>1315</sup> <http://www.bnfa.fr/cgi-bin/koha/pages.pl?pageID=E1a>.

<sup>1316</sup> <http://www.dedicon.nl/home>.

<sup>1317</sup> <http://grenzelooslezen.dedicon.nl/hoewerkthet>.

InfoSoc Dir)<sup>1318</sup>. A download by the end-user will result in a reproduction that should comply itself with the conditions of the exception in favour of people with a disability.

**Similar conditions.** While it is fairly straightforward that the production of the accessible copy should meet the conditions of the exception in the Member State where it is made and that the end-user's reproduction should comply with the exception in the Member State where the end-user performs the download or receives the streaming<sup>1319</sup>, this is not the case for the online offer of the accessible copies. An interested organisation that is willing to transmit an accessible copy to any person with a disability outside its Member State may be performing acts of communication or making available to the public in other Member States<sup>1320</sup>.

**Divergent conditions.** To the extent that the mere accessibility of a work may amount to a distinct act of making available to the public<sup>1321</sup> or communication to the public, the EU-wide use should be covered by either the right holders' consent or an exception in each Member State<sup>1322</sup>. The rights of communication to the public and making available to the public are indeed not exhausted by the communication with the right holder's consent in one Member State (art. 3(3) InfoSoc Dir).

Given the current state of implementation of the exception under consideration, it is practically excluded to offer a multi-territorial EU-wide online service to the benefit of people with a certain category of disabilities under the exception. Several Member States do not allow the communication to the public under the exception in favour of people with a disability (Denmark, Germany, UK).

For example, a Belgian organisation assisting visually impaired people is allowed under Belgian copyright law to offer services online and to make available spoken versions of books. The spoken books can be offered to the German speaking beneficiaries accessing the service from the Belgian territory. To the extent that an act of making available to the public is found in Germany, the organisation cannot rely on this exception under German law (which does not exempt acts of communication to the public) but it must acquire the right holders' authorisation.

An interested organisation could then restrict its offer to beneficiaries residing in Member States where the exception tolerates the communication or making available to the public of accessible copies. It should always be verified whether the conditions are met in the Member State of destination (i.e. where the beneficiary person with a disability is when she accesses the copy). This does not entail too many complications when the exceptions in the Member States exempt acts of communication to the public and making available to the public under similar circumstances.

For example, the Belgian organisation offers accessible copies to beneficiaries in Belgium in conformity with the conditions in the Belgian copyright act (i.e. it verifies that it only transmits the copies to people with a disability, the copies are adapted, relate directly to the disability, are of a non-commercial nature and do not exceed what is required by the specific disability). It also transmits such copies to beneficiaries in Luxembourg. To the extent that it thus performs an act of communication or making available to the public in Luxembourg, it must be complied with the exception in the Luxembourgish copyright act. The exceptions in the Belgian and Luxembourgish laws allow acts of communication and making available to the public under similar conditions, hence the right holder cannot prohibit the offer to beneficiaries in Luxembourg on these grounds. Furthermore, the Luxembourgish exception exempts the reproduction of the accessible copy

---

<sup>1318</sup> Cf. *Study on the territoriality of the making available right*, final report, I, C, 3.

<sup>1319</sup> See Opinion of Advocate-General JÄÄSKINEN in case C-170/12, *Peter Pinckney v KDG Mediatech AG*.

<sup>1320</sup> Cf. *Study on the territoriality of the making available right*, final report.

<sup>1321</sup> Cf. *Study on the territoriality of the making available right*, final report.

<sup>1322</sup> Even if a more restrictive view of the making available right and/or communication right is taken (cf. « targeting » approach of the CJEU), it is likely that an online service will entail restricted acts in several Member States.

hence the download at the beneficiary's end can take place without the right holder's consent as well.

Other Member States do allow a restriction of the communication right under this exception but under different conditions (some distinctly stricter than others).

This complicates the matter. For example, an interest group in Belgium may have adapted a novel to the needs of visually impaired people in the form of an audio book and have made it available via its website (which may restrict access to the work to its members so it can verify that only people with this disability can download it). Such use may be in conformity with the legal conditions of the Belgian legislation, which merely requires that the acts of reproduction and communication be directly related to the disability, be of a non-commercial nature and not exceed the extent required by the specific disability. There are no specific (formal) requirements as to the person with the disability or the organisation that may produce the accessible copy.

To the extent that the work is accessible in France, a distinct act of communication or making available to the public may be found in France. Consequently, the French copyright act should be respected and the use must be authorised or exempted under French law. Furthermore, the download of the work results in a reproduction, made in France and therefore governed by French law as well. The French law contains more specific requirements regarding the beneficiary person and the establishment or legal entity reproducing and communicating the accessible copy to the beneficiaries. Whether this actually restricts the cross-border accessibility of the works also depends on the interpretation and application of the criteria in practice<sup>1323</sup>.

**Options.** Whenever the national copyright laws of the Member States, where an organisation intends to be active, set different conditions, the organisation should adapt its offer to comply with the applicable law. It has several options:

- It may offer distinct services for each national territory, in conformity with the conditions of the national exception.
- It may rather decide to offer its services only to the people staying on the territory of one Member State, most likely the one where it has its establishment and where it is familiar with the applicable legislation, or the Member State where the most lenient exception is provided.
- It may offer a multi-territorial service, in conformity with the conditions of the strictest exception (assuming thus that the conditions of the more lenient exception will automatically be respected).
- Finally it may see itself compelled to acquire the right holder's consent for certain territories.

**TPMs and overriding the exception by contract.** The cross-border access to online sources with accessible materials is further complicated by the diverging regimes for technological protection measures and the possibility to override any limitations in favour of people with a disability by contract.

As far as the contractual overrideability is concerned, it has been mentioned that few Member States have included an express provision in their copyright laws dealing with this issue. Where it is permissible to exclude the application of an exception by contract on a national basis, the beneficiaries of the exception may find their position weakened by the contractual practices of the right holders. This tension between the exception and the possibility to override it by contract may have cross-border effects. Imagine a situation where two Member States provide similar exceptions in favour of people with a

---

<sup>1323</sup> The French law for example requires either a certain degree of disability or a medical certificate. If a Belgian blinds' organisation wants to offer its services in France, it may have to organise its service so it operates a check of the medical certificates or the degree of disability for the users residing in France. In addition, in order to operate in France, the organisation will have to be included in a list of legal entities recognised by the ministries in charge of culture and disabilities (cf. VERCKEN & ARMANET, National report France, ALAI conference Dublin, 2011, 16: "*habilités conjointement par le ministre chargé de la culture et le ministre chargé des personnes handicapées*").

disability and that would allow a beneficiary in one Member State accessing works made available under the exception in the other Member State. The one Member State (A) allows the right holder to discard the exception by contract, the other Member State (B) does not. A beneficiary Member State B thus enjoys the exception, despite the right holder's objections, and an interested organisation can make the work accessible to beneficiaries in Member State B. In Member State A, the right holder can discard the exception. The beneficiaries in Member State A can still have access to accessible copies originating in Member State B (to the extent that the other conditions are met). Inversely, where the right holder has used her possibility to contractually exclude the application of this exception in Member State A, beneficiaries in Member States A and B will have to negotiate a licence with the right holder.

All Member States are obliged to safeguard the application of the exception against TPMs (art. 6(4) InfoSoc Dir). Each Member State can implement a procedure to be followed to achieve this. However, TPMs cannot be discarded when the works or other subject-matter were made available to the public "*on agreed contractual terms in such a way that members of the public may access them from a place and at a time individually chosen by them*". Since it is common for on demand available works to be protected by TPMs and to be governed by a licence (including standard terms and conditions), the right holder could maintain the technical protection to the detriment of the beneficiaries of the exception. The beneficiary will not be able to use the work or subject matter thus made available in order to perform (or have others perform) the acts of reproduction, communication to the public (including making available) and distribution permitted under the exception. This means that the beneficiary (or another person on her behalf) will have to negotiate a licence with the right holder, who may impose additional conditions (such as payment of a fee or territorial restrictions to the online access). The priority given to TPMs and contractual practice is unlikely to increase the use people with a disability can make of a work or the cross-border accessibility.

**Summary.** Where an accessible copy is communicated or made available to the public in other Member States than the one where offer originates from, it must be verified whether the exception in favour of disabled people in those other Member States exempts such act of communication or making available and whether the conditions of the exception are met. Given the disparities in the national laws (some Member States providing no exception to the right of communication or making available to the public), an EU-wide service offering access to accessible copies in each and every Member State is excluded under the exception. Where Member States do provide an exception to the right of communication and making available to the public, it must be verified whether any particular service complies with the exception in the Member States where such acts of communication and making available to the public are found. The disparity between the Member States' exceptions is likely to discourage the cross-border online access to accessible copies.

Cross-border access to adapted works and other subject matter is even less likely to be stimulated where the Member States allow that the exception be overridden by contract. The contractual exclusion of an exception may have effects on beneficiaries in the same and in other Member States (who are required to negotiate a licence). Inversely, where the exception cannot be ruled out by contract, the accessible copies may be created and made accessible in one Member State and in other Member States (where the accessible work is made available but no contractual control can be exerted). The imperative character of the exception may be lost in case the work is made available on demand, on agreed contractual terms.

The legal protection of technical protection measures may be also impede the cross-border availability of an accessible copy. This effect of TPMs may be mitigated to safeguard the benefit of certain exceptions. This safeguard is however itself diminished where a work or other subject matter is made available on demand, on agreed contractual terms. In that case, the beneficiaries, their interest groups or intermediary organisations may be compelled to negotiate a licence subject to conditions (such as the payment of a fee or territorial restrictions).

## V. Possible solutions

The disparities in the national exceptions may create obstacles to the cross-border sharing of tangible copies or intangible copies and services, accessible to people with a disability. The Rapport LESCURE states that it affects the circulation of works in an adapted format<sup>1324</sup>. GUIBAULT even considers that these disparities might lead to some kind of discrimination between the EU citizens. She explains that *“the diversity of ways that this limitation has been transposed in the Member States is bound to give rise to differences in treatment between citizens of different countries, which could be contrary to the principle of non-discrimination laid down in the EC Treaty”*<sup>1325</sup>. The current principle of exhaustion cannot overcome the national differences and neither can the current state of harmonisation of the exception.

There are several options to deal with the current situation.

**Do nothing.** It is not self-evident that a legislative intervention is necessary. As has been demonstrated in the previous section, there are many disparities in the implementation of the exception in the national copyright laws. In theory this situation would suggest that the offer of accessible works is negatively affected. This should however be verified in an empirical study, all the more since the Commission has taken an initiative to facilitate the voluntary cooperation between right holders and “trusted intermediaries” and thus increase the offer of accessible works.

In 2010, a **Memorandum of Understanding** was adopted between the EU Stakeholders on access to people with print disabilities<sup>1326</sup>, following the communication on Copyright in the Knowledge Economy<sup>1327</sup>. The purpose was to increase the number of accessible works, for people with a “print disability”. This objective is pursued by supporting the publishers’ effort of producing content in an accessible form, but also by creating a network of “Trusted Intermediaries”, which should be able to create accessible content and ensure the controlled distribution of accessible copies of works, when these are commercially available, to persons with a print disability. TIs must have the trust of representatives of both persons with a print disability and rightholders and be specifically accredited at national level. There should be a TI in every Member State.

The Memorandum was signed by several stakeholders (Federation of European Publishers, European Blind Union, European Writers Council, European Dyslexia Association, International Federation of Reproduction Rights Organisations and International Association of Scientific, Technical and Medical Publishers). The Memorandum contains a number of definitions (a “person with a print disability” (as the end-user), the right holder, Trusted Intermediary).

The stakeholders, with the support of the European Commission, are currently working on the practical implementation of the commitments set out in the MoU. For this purpose the parties have established the “European Network of Trusted Intermediaries” (ETIN). This is a Brussels-based network representing both trusted intermediary organisations and rights holders. It aims to have pan-European coverage. The ETIN has agreed a model licence/agreement for the cross-border transmission of accessible copies of works. This model licence/agreement is put forward as a basis for arrangements between potential TIs and right holders at national level.

---

<sup>1324</sup> P. LESCURE, Culture Acte 2, Mission « Acte II de l’exception culturelle », Contributions aux politiques culturelles à l’ère numérique, 442, [http://www.culturecommunication.gouv.fr/var/culture/storage/culture\\_mag/rapport\\_lescore/index.htm#1](http://www.culturecommunication.gouv.fr/var/culture/storage/culture_mag/rapport_lescore/index.htm#1).

<sup>1325</sup> GUIBAULT, “Why Cherry-Picking Never Leads to Harmonisation”, 64.

<sup>1326</sup> EU Stakeholders Dialogue Memorandum of Understanding (MOU) on access to works by people with print disabilities, accessible via [http://ec.europa.eu/internal\\_market/copyright/initiatives/access/index\\_en.htm](http://ec.europa.eu/internal_market/copyright/initiatives/access/index_en.htm).

<sup>1327</sup> *Communication of the Commission, Copyright in the Knowledge Economy*, COM(2009) 532 final, 19 October 2009, [http://ec.europa.eu/internal\\_market/copyright/docs/copyright-infso/20091019\\_532\\_en.pdf](http://ec.europa.eu/internal_market/copyright/docs/copyright-infso/20091019_532_en.pdf).

We have no information on the effects of this ETIN initiative but they should be considered when assessing the need to intervene on the exception in favour of people with a disability. It may lead to an increased availability of accessible works and make a legislative intervention redundant.

**Alternative options.** To the extent that an intervention is necessary or desirable, the national divergences could be solved in various ways. It should be remarked that this may be a delicate matter, since the exception touches upon other policy domains, which are not harmonised at the European level (social integration policy, equality and non-discrimination or social security laws). Member States may want to integrate this in a broader policy regarding people with disabilities. Nevertheless, the cross-border mobility of accessible copies may be pursued in various ways.

Firstly, there is the solution in the WIPO Marrakesh Treaty on limitations and exceptions for visually impaired persons/persons with print disabilities. Secondly, the exception in favour of people with a disability could be harmonised in a more stringent way. Thirdly, the exhaustion rule could be extended to copies produced under a national exception in favour of disabled people. Finally, alternative solutions could be found in common European law (e.g. principle of mutual recognition). We will focus on the first two possibilities, leaving aside the third and the fourth since these are likely to have wider implications for other rights or exceptions than the one under consideration<sup>1328</sup>.

**WIPO Marrakesh Treaty.** The Marrakesh Treaty should already address a number of the cross-border issues<sup>1329,1330</sup>. According to PAPADOPOULOU, *“the most important feature of this proposed treaty though is that it aspires to legalize the cross-border exchange and the sharing of the legally made collections under copyright exceptions. Specifically it permits the export to another country of any version of the work or copies of the work that any person or organisation in one country is entitled to possess or make under the treaty proposal, and the import of that version of a work or copies of the work under the provisions of the treaty proposal in the other country”*<sup>1331</sup>.

The treaty defines the **beneficiary** of the exception as a person who (a) is blind, (b) has a visual impairment or a perceptual or reading disability which cannot be improved to give visual function substantially equivalent to that of a person who has no such impairment or disability and so is unable to read printed works to substantially the same degree as a person without an impairment or disability or (c) is otherwise unable, through physical disability, to hold or manipulate a book or to focus or move the eyes to the extent that would be normally acceptable for reading (art. 3 Marrakesh Treaty). In this respect the draft treaty is narrower than the Information Society Directive, which benefits people with a disability without determining the type of disability.

It also provides a definition of **“authorised entities”**, i.e. entities that are authorized or recognized by the government to provide education, instructional training, adaptive reading or information access to beneficiary persons on a non-profit basis (art. 2(c) Marrakesh Treaty). This includes government institutions or non-profit organizations that provide the same services to beneficiary persons as one of its primary activities or institutional obligations.

---

<sup>1328</sup> We refer to the analysis and suggestions re the principle of exhaustion of the distribution right and the principle of mutual recognition in the reports on Outputs 5-7 of Part I of the Study. on the Application of Directive 2001/29/EC on Copyright and Related Rights in the Information Society (the “InfoSoc Directive”).

<sup>1329</sup> Marrakesh Treaty to facilitate access to published works for persons who are blind, visually impaired or otherwise print disabled, adopted by the Diplomatic Conference, Diplomatic Conference to Conclude a Treaty to Facilitate Access to Published Works by Visually Impaired Persons and Persons with Print Disabilities, Marrakesh, June 17 to 28, 2013, accessible via [http://www.wipo.int/meetings/en/doc\\_details.jsp?doc\\_id=241683](http://www.wipo.int/meetings/en/doc_details.jsp?doc_id=241683).

<sup>1330</sup> See for a historical background : I.S. NWANKWO, “Proposed WIPO Treaty for Improved Access for Blind, Visually Impaired, and other Reading Disabled Persons and its compatibility with TRIPS Three-Step Test and EU Copyright Law, *Jipitec* 2011, (203) 205.

<sup>1331</sup> PAPADOPOULOU, “Copyright exceptions and limitations for persons with print disabilities”, 12.



As far as the **restricted acts** are concerned, the contracting parties are required to provide a limitation to the rights of reproduction<sup>1332</sup>, distribution, making available to the public<sup>1333</sup> as defined in the WIPO Copyright Treaty, in order “*to facilitate the availability of works in accessible format copies for beneficiary persons*” and allow the changes required to make the work accessible in the alternative format (art. 4 Marrakesh Treaty). The contracting parties are allowed (but not obliged) to provide a limitation of the right of public performance. The notion of “accessible format copies” is defined in article 1(b) of the treaty, as “*a copy of a work in an alternative manner or form which gives a beneficiary person access to the work, including to permit the person to have access as feasibly and comfortably as a person without visual impairment or other print disability. The accessible format copy is used exclusively by beneficiary persons and it must respect the integrity of the original work, taking due consideration of the changes needed to make the work accessible in the alternative format and of the accessibility needs of the beneficiary persons*” (without specifying whether these copies are tangible or intangible or digital copies).

The Marrakesh Treaty proposes two clauses that would comply with the international obligations under that Treaty, outlining the conditions on which the “authorised entities” and the beneficiary persons may use the work under this exception (art. 4(2) Marrakesh Treaty). The contracting states have some freedom regarding the way the exception is implemented (Art. 4(3) Marrakesh Treaty). Moreover, they are free to restrict the application of the exception to works which, in the particular accessible format, cannot be obtained commercially under reasonable terms for beneficiary persons in that market (art. 4(4) Marrakesh Treaty) and to make the exceptions subject to a remuneration (art. 4(5) Marrakesh Treaty).

**Cross-border exchange.** The Treaty contains particular provisions dealing with the cross-border exchange of accessible format copies (article 5, 6, 9 Marrakesh Treaty). It is provided that “*Contracting Parties shall provide that if an accessible format copy is made under a limitation or exception or pursuant to operation of law, that accessible format copy may be distributed or made available by an authorized entity to a beneficiary person or an authorized entity in another Contracting Party*” (art. 5(1) Marrakesh Treaty). It then provides two examples of provisions that would comply with the international obligation under the Treaty (art. 5(2) Marrakesh Treaty). An authorised entity is thus allowed to distribute an accessible format copy or to make it available to beneficiary persons *in another contracting state*, even by the intermediary of another authorised entity in another contracting state. The authorised entities have more legal certainty that their activities will be tolerated in the contracting states of destination.

Complementing this provision, the Marrakesh Treaty also regulates the **importation** of accessible format copies: “*to the extent that the national law of a Contracting Party would permit a beneficiary person, someone acting on his or her behalf, or an authorized entity, to make an accessible format copy of a work, the national law of that Contracting Party shall also permit them to import an accessible format copy for the benefit of beneficiary persons, without the authorization of the rightholder*” (art. 6 Marrakesh Treaty). This would mean that the right holders cannot prevent the import of accessible format copies *to the extent* that the national law permits a beneficiary, someone on her behalf or an authorised entity to *make* an accessible format copy. It is not specified that the accessible format copy should be imported from a state party to the Marrakesh Treaty. It is not clear whether “import” only concerns tangible copies of a work or extends to the making available of digital copies.

In addition, a less compelling provision encourages contracting states to facilitate the voluntary sharing of **information** so authorised entities can identify each other (art. 9 Marrakesh Treaty).

The Marrakesh Treaty also contains some obligations concerning technological measures. Contracting Parties are bound to take “appropriate measures” to ensure that their legal protection against the circumvention of effective technological measures does not prevent beneficiary persons from enjoying the

---

<sup>1332</sup> It should be remarked that the WIPO Copyright Treaty does not deal with the reproduction right as such, except in the agreed statement concerning art. 1(4) where it refers to art. 9 of the Berne Convention.

<sup>1333</sup> It should be remarked that the WIPO Copyright Treaty harmonises the right of communication to the public, including the making available to the public. It seems that the draft treaty proposes a restriction only to the making available right.

limitations and exceptions provided for in the Treaty (art. 7 Marrakesh Treaty) An article on the relationship between the exception and contracts has been deleted (Art. G, Draft Treaty in the version of 23 November 2012, SSR/25/2<sup>1334</sup>).

Similar provisions could be envisaged at the **European level**. The solution under the Marrakesh Treaty makes it mandatory to provide an exception in favour of people with a visual impairment and it determines the protected acts must be curtailed (reproduction, distribution, making available to the public) or may be limited (public performance). The contracting states have a margin to impose conditions or to modulate the exception in their national law (commercial availability, remuneration).

The Directive could make the existing exception mandatory<sup>1335</sup> and restrict the right to control the distribution, the communication and making available to the public between Member States of the European Union (i.e. across the borders of the Member State where the copy was produced in conformity with the national exception, towards another Member State). In order to ensure the cross-border exchange of accessible format copies within the EU, it could be explicitly provided that the production of an accessible copy in one Member State entails that this copy may be distributed, communicated or made available to the public in any other Member State (even if this Member State of destination provides a stricter exception in its copyright law). This provision should suffice to indicate that both “import” and “export” sides of the distribution are thus covered. This cross-border availability may entail that the more lenient exception of one Member State has extra-territorial effects in other Member States, where the stricter exception in the Member State of “destination” (where the extra-territorial effects are felt) cannot be invoked to oppose it.

This leaves an issue in case of an offer for download of an accessible format copy. The beneficiary in the Member State of destination makes another reproduction in the Member State of destination, which in principle is subject to the exception in that Member State (not in the Member State where the download originates). Any provision permitting the making available of accessible copies for download should make sure the consequent reproduction at the beneficiary’s end is not subject to the right holder’s consent.

The Member States could still make the exception subject to different conditions, but the right holders would not be able to rely on “their” (stricter) national exception to prohibit an import of an accessible copy that meets the conditions in another Member State (at least not in every case).

For example, a blind organisation in Member State A could produce accessible format copies in under the exception in the copyright act of Member State A and could distribute these copies within Member State A or make these accessible copies available online. If a beneficiary person in Member State B wants to receive an accessible copy on a material support or in digital form, the organisation has to verify whether this person qualifies by reference to the exception in Member State A, regardless of the stricter or more lenient exception in Member State B.

In this construction, the exception of one Member State has effects in another Member State. It will matter to determine how this Member State should be designated: should this be the Member State where the accessible format copy was adapted and/or reproduced? Or should it be the Member State where the blind organisation is established and has its principal activities?

The Marrakesh Treaty does not determine how the exception should relate to technical protection measures (and their legal protection), nor does it require the contracting states to treat the exception with

---

<sup>1334</sup> In a previous version, it was provided that “*nothing herein shall prevent Member States/Contracting Parties from addressing the relationship of contract law and statutory exceptions and limitations for beneficiary persons. Alternative A: Contracts that override the exercise of the provisions herein specified shall be null and void. Alternative B: Nothing here shall prevent the Member States/Contracting Parties from treating the limitations or exceptions provided to beneficiary persons under this treaty as immune from private contracts and such contracts entered into in violation of provisions of this treaty are null and void*”.

<sup>1335</sup> The exception in the InfoSoc Directive has a larger scope of application than the Marrakesh Treaty, which is restricted to visual impairments. There is no need to restrict the scope of the InfoSoc Directive in this respect.

priority over contractual arrangement. In principle the European Union remains free to keep its preferential treatment of the right holder over the beneficiary in case the work or other subject matter is made available on demand and on agreed contractual terms. Where a work or other subject matter is available on demand “on agreed contractual terms”, the exception could be overruled by contract and the TPMs must not yield for the use in favour of the beneficiary. This priority would affect the efficiency of this exception and make the production and distribution of accessible content subject to the right holders’ consent (whereas the digital, networked environment in theory allows protected matter to be more available to people with a disability, given the lower costs to adapt the matter to their needs and to distribute it to them). In that case nothing would prevent a right holder from granting a licence only for a particular territory, thus undermining the efforts to enhance the cross-border exchange within the EU of accessible copies.

**More compelling harmonisation.** The national divergences can be explained by a lack of concrete guidelines in the Information Society Directive for Member States to follow in determining the scope and conditions of the exceptions<sup>1336</sup>. If it is verified that the current divergences unduly impede the cross-border accessibility to accessible works or the functioning of the internal market, then a more stringent exception could be considered. In order to be fully effective, several points should be taken care of.

Firstly, the exception in favour of people with a disability should be made **mandatory** in order to safeguard this exception in the future or in the legislation of new Member States. An exception of this kind was found in the legislation of all Member States under consideration in the current Study. It has not been verified for the other Member States.

Secondly, the **exploitation rights** restricted under the exception should be listed in a way that leaves the Member States no margin. Currently the Member States are free to decide whether the exception applies to the rights of reproduction and/or communication to the public (including the making available right) and/or distribution. In order to allow the creation and production of accessible format of works, the reproduction right should be restricted as should the adaptation right, keeping in mind though that the adaptation right is not harmonised in the Information Society Directive. The cross-border accessibility should be addressed through the restriction of the right of communication to the public including making available to the public, to the extent required to ensure online services, and the distribution right. In the current state, the Information Society Directive leaves it up to the Member States whether they extend the exceptions to the reproduction right to the distribution right (art. 5(4) InfoSoc Dir). This could be changed in order to limit distribution right as well, relevant for the import resp. export of accessible copies.

Thirdly, the **beneficiaries** of the exception could be more clearly stated. It is undisputed that the individual with a disability is the end-user of the copy or service. There is no uniformity in the national laws concerning the disability (visual impairments v others) or the exact description of the disability. In scholarly literature and at the international level, most attention has been paid to the blind and the visually impaired (*sensu lato*), which could indicate that people with other disabilities find means to access content outside copyright. As far as **other actors** are concerned, it could be explicitly stated that the exception also applies when the restricted acts are performed by individuals acting on behalf of the individual with a disability or interest organisations and intermediary entities. These intermediaries could be required to meet certain standards (verification of beneficiaries, “due care” in restricted use, privacy of beneficiaries). It should be taken into account that in its current form the Information Society exempts only uses of a non-commercial nature.

Fourthly, the **effect of additional conditions** should be assessed. As has been demonstrated *supra*, the Member States make very different exceptions in favour of people with a disability. It is not within the scope of this study to express an opinion of which additional conditions (by reference to the Directive) should be maintained or discarded. Regard should be had for the requirements in the Information Society that the exempted uses should bear a direct relation to the disability, should be of a non-commercial

---

<sup>1336</sup> GUIBAULT, “Why Cherry-Picking Never Leads to Harmonisation”, 64.

nature and are permitted only to the extent required by the specific disability. Furthermore, the three-step test can be relied upon to control the impact on the exploitation of the works and the prejudice of the right holders. In this strand it may be considered to explicitly add the condition proposed in the Marrakesh Treaty that the limitation only applies to works or other subject matter which cannot be obtained commercially in a particular accessible format, under terms reasonable for beneficiary persons in that market (as is already the case in some Member States). Inversely, it could be considered to impose an obligation upon the right holders (such as publishers) to make the work or other subject matter available in a form which would facilitate the task of (trusted) intermediaries of producing an accessible version of the work (e.g. France). The effect should be assessed of the obligation, in some Member States but not in others, to pay remuneration for the copies that are produced and distributed under this exception (in particular where it should be paid and by whom).

Some Member States have merely taken over the conditions in the current exception in favour of people with a disability, without imposing additional conditions. Even if this solution were generalised to all Member States, attention should also be paid to **concrete practices** within the borders of this exception, which may have some restricting effect. The end beneficiaries could be asked to provide proof regarding their disability (or its degree), e.g. by means of a medical certificate. Interest organisations or right holders may be inclined to require a medical certificate from their own Member State, to warrant certainty concerning the actual disability or the authenticity of the certificate. Such national medical proof may be hard to come by so this requirement may restrict the cross-border accessibility. On the other hand Member States (and right holders) may demand that the interest organisations or “intermediaries” obtain some national (administrative) recognition before their actions on behalf of the final beneficiaries are exempted under the national exception. Consequently, an organisation should apply for such recognition in each Member State where it wants to deploy activities. Depending on the complexity of the national procedures this may have an off-putting effect. These corollaries may be softened by some sort of “mutual recognition”<sup>1337</sup>, perhaps through a network of intermediaries like the network of Trusted Intermediaries proposed in the existing Memorandum of Understanding (taking into account that the Trusted Intermediaries may be required to meet certain qualities – *supra*). An object distributed or a service offered by such intermediary in one Member State in conformity with the national exception should then be able to circulate within the EU.

Finally, a stand could be taken regarding the **imperative** (unwaivable) nature of this exception. This would state the priority to be given to the exception in favour of people with a disability over contractual terms for any online service. Similarly the protection of TPMs could be adjusted in order to safeguard the benefit of this exception (even in case of an online service), by extending the safeguard to “works or other subject-matter made available to the public on agreed contractual terms in such a way that members of the public may access them from a place and at a time individually chosen by them” (cf. art. 6(4) par. 4 InfoSoc Dir).

---

<sup>1337</sup> We refer to the analysis in the reports on Outputs 5-7 of Part I of the Study, on the Application of Directive 2001/29/EC on Copyright and Related Rights in the Information Society (the “InfoSoc Directive”).

## Bibliography

### Cases

CJEU, case 19/84, 9 July 1985, *Pharmon v Hoechst*

CJEU 12 September 2006, case Case C-479/04, *Laserdisken ApS v Kulturministeriet*, Reports of Cases 2006 I-08089

CJEU 17 April 2008, case C-456/06, *Peek & Cloppenburg v Cassina*

CJEU 16 June 2011, C-462/09, *Stichting De Thuis kopie v Opus Supplies Deutschland GmbH, Mijndert van der Lee, Hananja van der Lee*.

CJEU 21 June 2012, case C-5/11, *Donner*.

### Legislative and policy instruments

Marrakesh Treaty to facilitate access to published works for persons who are blind, visually impaired or otherwise print disabled, adopted by the Diplomatic Conference, Diplomatic Conference to Conclude a Treaty to Facilitate Access to Published Works by Visually Impaired Persons and Persons with Print Disabilities, Marrakesh, June 17 to 28, 2013, accessible via [http://www.wipo.int/meetings/en/doc\\_details.jsp?doc\\_id=241683](http://www.wipo.int/meetings/en/doc_details.jsp?doc_id=241683).

EU Stakeholders Dialogue Memorandum of Understanding (MOU) on access to works by people with print disabilities, accessible via [http://ec.europa.eu/internal\\_market/copyright/initiatives/access/index\\_en.htm](http://ec.europa.eu/internal_market/copyright/initiatives/access/index_en.htm).

Communication of the Commission, Copyright in the Knowledge Economy, COM(2009) 532 final, 19 October 2009, [http://ec.europa.eu/internal\\_market/copyright/docs/copyright-info/20091019\\_532\\_en.pdf](http://ec.europa.eu/internal_market/copyright/docs/copyright-info/20091019_532_en.pdf).

### Books

DUSOLLIER, S., *Droit d'auteur et protection des œuvres dans l'univers numérique*, Larcier, 2005, 582.

LIDNER, L. & SHAPIRO, T. (ed.), *Copyright In The Information Society*, E. Elgar Publishing, 2011, 523.

PEUKERT, A., "Territoriality and Extraterritoriality in Intellectual Property Law" in G. HANDL & J. ZEKOLL (ed), *Beyond territoriality: transnational legal authority in an age of globalization*, Queen Mary Studies in International Law, Brill Academic Publishing, Leiden/Boston, 2011, available at SSRN: <http://ssrn.com/abstract=1592263>.

WALTER, M.M. & VON LEWINSKI, S. (ed), *European Copyright Law*, Oxford, University Press, 2010, 1632.

### Articles

GUIBAULT, L., "Why Cherry-Picking Never Leads to Harmonisation: The Case of the Limitations on Copyright under Directive 2001/29/EC", *JIPITEC*, 2010/2, 55-66.

NWANKWO, I.S., "Proposed WIPO Treaty for Improved Access for Blind, Visually Impaired, and other Reading Disabled Persons and its compatibility with TRIPS Three-Step Test and EU Copyright Law, *JIPITEC* 2011, 203-216.

PAPADOPOULOU, M-D., "Copyright exceptions and limitations for persons with print disabilities: the innovative Greek legal framework against the background of the international and European developments", September 14, 2010). Available at SSRN: <http://ssrn.com/abstract=1874620> or <http://dx.doi.org/10.2139/ssrn.1874620>, 1-35.

TAN, C. , "Moving towards a more inclusive copyright regime for the visually impaired", *SAC LJ* 2012/24, 433-469.

## Studies

BLACA, National report United Kingdom, ALAI Congress Dublin, 2011, <http://www.alaidublin2011.org/wp-content/uploads/2011/04/United-Kingdom.pdf>, 54 p.

COLIN, C. & DE FRANQUEN, A., National report Belgium, ALAI Congress Dublin, 2011, <http://www.alaidublin2011.org/wp-content/uploads/2011/05/Belgium-FR.pdf>, 22 p.

LEISTNER, M., KOOF, A., KLEINEMENKE, M. & KOROCH, S., National report Germany, ALAI Congress Dublin, 2011, <http://www.alaidublin2011.org/wp-content/uploads/2011/04/Germany.pdf>, 25 p.

LESCURE, P., Culture Acte 2, Mission « Acte II de l'exception culturelle », Contributions aux politiques culturelles à l'ère numérique, 442, accessible via [http://www.culturecommunication.gouv.fr/var/culture/storage/culture\\_mag/rapport\\_lescore/index.htm#1](http://www.culturecommunication.gouv.fr/var/culture/storage/culture_mag/rapport_lescore/index.htm#1) .

SULLIVAN J., "Study on copyright limitations and exceptions for the visually impaired", WIPO Standing Committee on Copyright and Related Rights, 15th session, Geneva, September 11 to 13, 2006, [www.wipo.org](http://www.wipo.org), 18

VAN EECHOU, M., VAN GOMPEL, S., GUIBAULT, L, VAN DER SLOOT, B. & HUGENHOLTZ, B., National report The Netherlands, ALAI Congress Dublin, 2011, <http://www.alaidublin2011.org/wp-content/uploads/2011/05/Netherlands.pdf>, 16 p.

VERCKEN, G. & ARMANET, L-M, National report France, ALAI conference Dublin, 2011, 45 p.

*Study on the implementation and effect in Member States' laws of Directive 2001/29/EC on the harmonisation of certain aspects of copyright and related rights in the information society*, IViR, Amsterdam, 2007, 39 et s (hereafter IViR Implementation Study)

*The Recasting of Copyright & Related Rights for the Knowledge Economy*, IViR, 2006, 61 et s.

*Interface between exhaustion of intellectual property rights and competition law*, WIPO Secretariat, CDIP/4/4 rev./Study/INF/2, 1 June 2011, accessed via [http://www.wipo.int/edocs/mdocs/mdocs/en/cdip\\_4/cdip\\_4\\_4rev\\_study\\_inf\\_2.pdf](http://www.wipo.int/edocs/mdocs/mdocs/en/cdip_4/cdip_4_4rev_study_inf_2.pdf), p. 17-22



## User Generated Content (UGC) – First Part

### Description of the present legal situation regarding copyright in the European Union

By **Jean-Paul Triaille**, partner, De Wolf & Partners, and Lecturer (IT Contracts) at the University of Namur,

with the assistance of **François Coppens**, attorney-at-law, Brussels and researcher

The author wishes to thank Professor Jane Ginsburg (Columbia University, NY) for her input and the following national experts for their input on the situation in their country : for Denmark, Thomas Riis, Professor at University of Copenhagen, Faculty of Law; for France, Stéphanie Carré, Maître de Conférences, CEIPI, Université de Strasbourg; for Germany, Sylvie Nérison, Max Planck Institute for Intellectual Property and Competition Law, Munich; for Hungary, Peter Mezei, Assistant Professor at University of Szeged; for Italy, Giuseppe Mazziotti, Center for European Policy Studies (CEPS), Brussels; for Poland, dr. Maciej Barczewski, attorney-at-law, and Head of Postgraduate Program in Intellectual Property and High Technology Law, University of Gdansk; for Spain, Raquel Xalabarder Plantada, Vicerectorat d'Ordenació Acadèmica i Professorat Directora Adjunta, Universitat Oberta de Catalunya; for the United Kingdom, Estelle Derclaye, Professor of Intellectual Property Law, Faculty of Social Sciences, University of Nottingham.

The responsibility for this Study and for the opinions expressed herein remains with its author(s).





## Introduction

This Study is the first part of our report on User-Generated-Content (“**UGC**”). It concentrates on a description of the issues at stake, of the existing case-law, on the impact of UGC on exclusive rights, on the applicability of existing exceptions and on legal arguments which could be relevant, from within (or, sometimes, from outside) copyright, in order to allow UGC works to stay immune from copyright infringement proceedings.

This first part will be followed by a second one, in which we will list the various possibilities which the Commission could think of, should there be a need to promote UGC as a means of expression which should be encouraged to proliferate on the Web.

Apart from the analysis which we will do through these two parts of the Study, we think it would be useful that the Commission obtains the results of an economic/market analysis: through our lenses indeed, we could identify a number of issues, little case law and (in the second part) a number of possible solutions. But we could not identify, at least in any exhaustive or objective manner, the existence and/or consequences of a possible “chilling effect” of the existing legal framework on UGC projects which, due to this (existing or not) chilling effect, never materialised. This “hidden part of the iceberg”, if it exists, could only be examined via an economic/market analysis and via interviews<sup>1338</sup>; this was not part of our mission.

## Terms of reference

For the sake of clarity, it is important that the main elements of the terms of reference (the “**Terms of Reference**” or “the **ToRs**”) of our Study be explained from the beginning.

This Study takes place in an assessment exercise which the European Commission (“**the Commission**”) asked our firm to do in 2013, on the basis of article 12 of the Directive 2001/29/EC of the European Parliament and of the Council of 22 May 2001 on the harmonisation of certain aspects of copyright and related rights in the information society (“**the InfoSoc Directive**” or “**the Directive**”).

At the request of the Commission, we divided our analysis in two parts:

- first, a description of the “**as is**” situation (what rules apply to UGC ? are they adequate? is there case-law on UGC? how do commentators analyse the UGC phenomenon?) – this will be the subject-matter of this first part;
- in a second part, we will deal with the “**to be**” situation and analyse the need (or not) for the Commission to intervene on UGC and, if a need exists, how best the Commission could intervene. Obviously, we will list a number of possible options, ranging from “suggesting a specific UGC exception”, to... doing nothing.

---

<sup>1338</sup> We will mention other economic studies or market studies which were made by others, but they either date back to quite some time ago, or dealt with UGC in a more general sense, including all forms of UGC (which is not what our report is about – see infra for the notion of UGC which we will rely upon).

The general purpose of the Study commissioned to our firm on UGC is “to assess the extent to which the implementation of the Directive is appropriate to the economic and technological realities of digital markets and evaluate whether and, if so, to what extent, further harmonisation in some areas of copyright is needed in order to enable the EU to capitalize on the opportunities of a digital single market”. As Internet and digital technology are rapidly changing the way in which works and other protected subject matter are produced, distributed and used, many of these changes could not be reflected nor sometimes even envisaged in the report that was undertaken in 2006<sup>1339</sup>. Moreover, as recalled by the Terms of Reference, the Court of Justice of the European Union (“CJEU”) and national courts have rendered numerous decisions since then – not on all issues which are the subject matter of our Study, though, as we shall see.

Differently from some of the other reports we were asked to prepare for the Commission, the present Study does not deal with an exception which already exists, as such, in the Directive, but covers “User-Generated-Content” (“UGC”) (as will be defined later). The Commission was of the opinion that some key limitations and exceptions needed to be reassessed (see ToRs, p. 3) but considered, in the line of previous Commission documents which we will list further, that UGC also deserved consideration in the reassessment exercise of the Directive. The Commission therefore did not want to limit the exercise to examining exceptions which were already provided for by the Directive but wanted to also examine the need for possible new exceptions, like one which would deal with UGC.

## I. Subject matter

As noted by the Terms of Reference (p. 5), “the fast development of social networking and social media sites which rely on the creation and upload/distribution of online content by end-users raises a certain number of questions in terms of copyright. These new applications enable users to generate new content and new practices for media and artistic expressions have emerged”. While some stakeholders argue in favour of a new exception to cover such UGC, others argue for increased flexibility and clarity of the already existing exceptions of the closed list of the Directive, together with the application of the 3-step test (Directive, art. 5(5)), not only to facilitate UGC but also to facilitate the emergence of new business models for commercial users; others take the view that licensing schemes should be the preferred option and insist that such schemes are increasingly available.

In conformity with the ToRs, we will assess the scope which might already exist in the Directive’s list of exceptions for non-commercial UGC. We will examine whether much case-law exists on these issues, and whether courts have resorted to exceptions from the Directive. We will also examine, in the hypothesis that one (or several) exceptions do provide scope for UGC, whether the Member States implemented these exceptions in a consistent and similar way or whether the implementation has led to varying solutions, with the consequence that the user is not offered a uniform/harmonized playing field when seeking to communicate UGC via the Web.

As suggested by the ToRs, we will also examine whether courts found flexibility outside of copyright (and outside of the closed list of exceptions of the Directive) to allow UGC uses for which copyright legislation (i.e. mainly the InfoSoc Directive) has not provided the necessary scope and/or exceptions. Should only little case law exist, we will then look at alternatives which we (i.e. the authors of this report on UGC) or other legal commentators have thought of, as possible alternatives to provide space for UGC (should the need be proven), while no explicit exception exists for it in the InfoSoc Directive. As invited by the ToRs, we will also examine (in the second part of our report) whether legal arguments inspired from a kind of

---

1339 Report by the Institute for Information Law (IVIR), Study on the implementation and effect in Member States’ laws of Directive 2001/29/EC on the harmonization of certain aspects of copyright and related rights in the information society, Parts I & II, February 2007.

“fair use “ exception in the US-style could be a solution to allow some UGC uses which could not be justified on the basis of the InfoSoc Directive (or other extra-copyright defences already available in the EU) but which one might reasonably expect should be allowed.

**Other legal aspects** than those related to copyright may be important for UGC but are not part of this Study. One may think of infringements to other IP rights such as trademarks, registered designs, new rules on orphan works, of consumer law protection (and the fair/unfair character of some of the contract terms and conditions of certain content-sharing platform or social networks), of privacy issues, of defamation law issues, of rules on harmful content, on the liability of UGC platforms (even though we may need to allude to that issue), of audiovisual and media law issues, of market practices of platforms, of rules on publicity, of the protection of minors, etc. Some of these issues are more and more relevant, some are losing in importance; we shall not examine them here in any detail: they are not part of the ToRs.

Our Study concentrates, as asked for by the ToRs, on **non-commercial UGC**. Obvious examples of commercial UGC would be examples where a firm develops a UGC work, on the basis of pre-existing works and makes it available on the Web for commercial purposes. This is not part of what we will analyze (and there does not seem to be any good reason to think of any exception for this type of use, without even mentioning the fact that such exception would probably run contrary to the three-steps-test).

The commercial/non-commercial criterion seems however sometimes hard to draw, as most UGC generated by individuals is non commercial to start with (see *infra*: most users are not interested in making money out of their “creations”). However, a UGC video-clip might start as an obvious non-commercial endeavor yet become very popular, generate a lot of visits on the platform on which it is hosted and thus potentially generate substantial advertising revenues. Systems which have been progressively put in place (see *infra* about “monetizing agreements”) however do provide for a share of these advertising revenues between the platform and the rightholder (holder on the copyright on the pre-existing work on the basis of which the UGC was later created), but they do not foresee any revenue for the UGC generating individual. Furthermore, the **commercial v. non-commercial** character is, for most issues in copyright and for most exclusive rights, not a relevant criterion to decide whether a licence is needed (even if it may have an impact on the amount of fees which the licensor will ask or on the amount of damages which a court would impose on the infringer) and the distinction will thus hardly ever be a trigger to decide about whether a specific act falls within the scope of an exclusive right or not. We therefore did not see it as a very useful criterion to investigate and, , we did not use it as a relevant criterion. This is all the more true that (1) what might be non-commercial at the beginning might later become “commercial” (and generate revenues) and (2) what one and the same use might be non-commercial for one party (i.e. *the individual user*) but commercial for other parties (i.e. *the platform*, if the UGC in question generates a lots of visits on the platform and therefore advertising revenues, and also *the rightholders* together with the platform if a monetization agreement is in place and the advertising revenues are shared between the platform and the rightholders). Inversely, the **public v. private** character of a use is often relevant to decide whether an act is infringing upon exclusive rights of an author (private reproduction v. non-private reproduction; communication to a public v. communication to a private group of individuals).

The purpose and subject matter of this Study is thus to examine the need (yes or no?) of a new UGC exception which would be added to the closed list of the Directive, whether it may prove more appropriate to suggest alternative routes or whether no initiative is needed, from the Commission’s side, regarding UGC.

## II. Definition(s) of UGC

There are various definitions of UGC and no official one<sup>1340</sup>.

We need to be clear, at the outset of this Study, that what we will consider as UGC (and what we will deal with in our Study) are cases where a pre-existing work is taken by a user as a starting point for his/her own expression. It means that we limit the examination to the situations where there is a pre-existing work and where such work will be modified in one way or another to then be made available online.

As a consequence, we exclude from our Study the two following scenarios:

- What we will call “**the creation from scratch case**”, i.e. the case where a user creates a new work “from scratch”, without relying on a pre-existing work. One could argue that all authors and, by the same token, all “users”, rely to a certain extent on pre-existing works to create their own. This is almost always true. But, under copyright terms and principles, it is a truism to say that “ideas are not protected” so that they can be reused by others<sup>1341</sup>. So, authors almost never really start “from scratch” because they are always somehow inspired by the work of contemporary or ancient authors or artists. Copyright does not prohibit that and has always accepted as a fact that authors could and did find inspiration in the work of others<sup>1342</sup>. In such cases, one should not talk about “User-Generated-Content” but “Author-Created-Content” or “User-Authored Content”<sup>1343</sup>.  
In such case of a creation from scratch, the author enjoys all the exclusive rights which copyright provides for, including the right to prohibit the reproduction of his work and its communication to the public or making available on the Internet. It is not the purpose of this Study to suggest that, as from now, authors should be deprived of such exclusive rights or granted new exclusive rights. The emergence of the internet does not change the equation in that respect and one could hardly understand why authors would have a right to e.g. prohibit the communication of their work on TV while they would not have the same right for the Web. Apart from being very technology-specific, such idea has no justification and would amount to abolishing copyright on the internet as such. This is not what this Study is about.
- What we will call the “**mere upload case**”, i.e. the case where a user merely distributes on the internet (by uploading and sharing it) pre-existing works without having intervened in any way on the work; some called this “User-Copied Content”<sup>1344</sup>. It is not the object of this Study to examine whether it would make sense to give such users a right to upload on the Internet any work which pre-exists and, concurrently, to create a new exception whereby uploading protected content on the internet would escape the exclusive rights of the authors. Here also, this would basically

---

1340 Because of the variety of definitions of UGC (or UCC – for User Created Content), obtaining or comparing existing economic or market data is very difficult because the studies available do not always cover the same reality. For a recent (if 2008 can still be said to be recent in this area?) and in a very detailed economic and market analysis of the UGC phenomenon, see IDATE, TNO & IVIR, *User-Created-Content: Supporting a participative Information Society, SMART, 2007/2008*, p. 27 to 174. See also the OECD Report, OECD, DSTI/ICCP/IE (2006)7/Final, Working Party on the Information Economy, *Participative Web: User Created Content*, 12 April 2007, p. 16.

1341 As stated by Desbois, « les idées sont de libre parcours » : « ideas are free as the air » (our translation).

1342 In US law, the « idea/expression » dichotomy is a well-known expression to explain that ideas may be reused and that a copyright issue would only arise where not only ideas but part of the expression of a previous work was also reused.

1343 D. Gervais, « The Tangled Web of UGC : Making Copyright Sense of User-Generated Content », *Vanderbilt Journal of Entertainment and Technology Law*, 2009, p.858.

1344 D. Gervais, « The Tangled Web of UGC : Making Copyright Sense of User-Generated Content », *Vanderbilt Journal of Entertainment and Technology Law*, 2009, p.859.

amount to saying that copyright does not apply on the internet. This is not what this Study is about either...

So, what interests us are situations where a “user” (therefrom the expression “User-Generated-Content”) relies on a pre-existing work, “arranges”<sup>1345</sup> it, and then uploads it on a website or web platform of some kind.

Examples of UGC are numerous on the Internet. Even if it usually assimilated with the appearance of platforms such as YouTube, DailyMotion, Flickr, MYspace, Facebook and all the others...., one may observe that back in the 1990s already, even if the technical interfaces of the online environment were not as colourful and audiovisual as they are today, the fundamental ingredients which reshuffled the production and distribution of creative works were already there: the means of producing and communicating content to the masses became available at low cost to every user connected to the Internet<sup>1346</sup>. But even if “User Created Content as such is not a new phenomenon”<sup>1347</sup>, “the differences lies in the scale, economic potential and impact on traditional supply chains of modern user created content”.<sup>1348</sup> Facebook and YouTube are sites devoted to UGC and are amongst the most visited websites on the internet, yet some legal scholars consider that “current copyright law leaves little or no room for sharing ‘user-generated content that builds upon pre-existing works’<sup>1349</sup>; at least, copyright has, up to now, not provided for a specific UGC exception.

There are borderline cases between the “mere upload” and the case where the user did generate something or modified something to the pre-existing work. For example, the intervention by the user may be rather minimal if he merely uploads the lyrics of a song after having recorded them in a video clip of which the images are pre-existing images of another video. In such case, the only thing which the user arguably has done is associating a number of seconds of music with a number of seconds of video images. Yet, this may raise specific concerns, in addition to the “mere copying” of sounds or of images. The association of pre-existing sounds with pre-existing images may raise issues of moral rights, if such association may cause a prejudice to the author of either the sound or of the images; it can sometimes also be rather creative (and thus give rise to copyright protection as such). We consider such example not to be a case of mere copying and uploading (but rather to be part of UGC).

On the other hand, when a user merely changes a file (be it a musical file, a video file or any other sort of file) from one technical format into another, it is then in our view a pure “format-shifting” action and we would consider this as a mere copying case (thus falling outside of the scope of this Study). When doing so, the user does not add any value or change anything to the contents of an existing work; he does not “generate” anything, in our view and for the sake of this Study at least.

**Types of UGC** are many, whether in the field of text, novel and poetry, in photo and images, in music and audio, in citizen journalism, educational content, games, virtual content, etc.

To each type of UGC correspond **different platforms or distribution models**, some being very popular, some being more “confidential” and used only by a little group of amateurs: blogs, wikis, podcasting,

---

1345 We say « arrange » to remain neutral at this stage. From a legal point of view, different qualifications might apply.

1346 N. ELKIN-KOREN, « User-Generated Platforms », in *Working within the Boundaries of Intellectual Property Rights*, Rochelle Dreyfuss et al., Oxford University Press, 2010.

1347 IDATE, TNO & IVIR, *User-Created-Content: Supporting a participative Information Society*, SMART, 2007/2008, p. 13.

1348 Idem.

1349 P.B. Hugenholtz & Dr. M.R.F. Sentfleben, *Fair Use in Europe. In Search of Flexibilities*, Amsterdam, November 2011 (available via [www.ssrn.com](http://www.ssrn.com)), p. 10.

social network sites, virtual worlds, content and file sharing sites, the most know of all being probably the video sharing site YouTube<sup>1350</sup>.

UGC is often described as content created by amateurs<sup>1351</sup>. For example, the OECD Report on UGC from 2007 defines UGC as “(i) content made publicly available over the Internet, (ii) which reflects a certain amount of creative effort, and (iii) which is created outside of professional routines and practices”<sup>1352</sup>. By referring to “a certain amount of creative effort”, the OECD definition might be putting the threshold too high if one wishes to grasp the major part of UGC. Even without much “creative effort”, a user might be generating UGC, just by adding parts (created by others) to existing parts (also created by others), or just by taking part out of a pre-existing work, or also by creating an association between two pre-existing works (and even these can lead to rather creative results).

One may observe that content which is created outside professional routines and practices is not necessarily amateur content if, by “amateur” one intends to refer to works of rather low levels of originality and low quality: UGC may indeed be produced by professionals outside the scope of their employment agreement<sup>1353</sup>. However, it is true that most of UGC is indeed produced by amateurs, private individuals spending time “outside of professional routines and practices”.

A phenomenon may be observed, of professionals putting their works on UGC platforms but, then, in most cases, the works will most often be created “from scratch” (as we excluded this category from our Study). Amateurs are more likely to rely on pre-existing works for the sake of facility and/or lack of own talent. However, it may be that the distinction between amateur and professional, or between professional and non-professional is blurring<sup>1354</sup>, which may be a reason of concern for the press, for instance.

Most user-created content activity is undertaken without the expectation of remuneration or profit<sup>1355</sup>, even if in some cases professional photographers, graphic designers free-lance journalists and similar professional categories providing pictures, news video, articles or other content have started to face competition from freely-provided amateur-created content<sup>1356</sup>. Some of the many reasons why users generate and distribute content include<sup>1357</sup>: advertising, analysis and commentary, contribution to human knowledge (Wikipedia), criticism and review, entertainment, education/support, malicious intent, news reporting, photo sharing, political campaigning, protest, social networking, vigilantism...

The concept of UGC we are relying on for the sake of this Study, somewhat different from the definition suggested by the OECD, concentrates, as explained before, on cases where a user will rely on one or

---

1350 For a systematic description of the different types of UGC, of the types of content and of platforms, see OECD, DSTI/ICCP/IE (2006)7/Final, Working Party on the Information Economy, Participative Web: User Created Content, 12 April 2007, p. 16 et s.; see also the classifications suggested by IDATE, TNO & IVIR, User-Created-Content: Supporting a participative Information Society, SMART, 2007/2008.

1351 S. HETCHER, « User-Generated Confusion : the Legal and Business Implications of Web 2.0”, 10 VAND. J. ENT. & TECH. L., 863, 871 (2008), as quoted by N. ELKIN-KOREN, op. cit., p. 12.

1352 OECD, DSTI/ICCP/IE (2006)7/Final, Working Party on the Information Economy, Participative Web: User Created Content, 12 April 2007, p. 4.

1353 N. ELKIN-KOREN, « User-Generated Platforms”, in Working within the Boundaries of Intellectual Property Rights, Rochelle et al., Oxford University Press, 2010, p. 13. The author gives as examples open source software projects which evolve in high quality software, or pictures taken by a professional photographer and then posted on Flickr.

1354 N. ELKIN-KOREN, « User-Generated Platforms”, in Working within the Boundaries of Intellectual Property Rights, Rochelle et al., Oxford University Press, 2010, p. 14.

1355 OECD, DSTI/ICCP/IE (2006)7/Final, Working Party on the Information Economy, Participative Web: User Created Content, 12 April 2007, p. 4.

1356 OECD, DSTI/ICCP/IE (2006)7/Final, Working Party on the Information Economy, Participative Web: User Created Content, 12 April 2007, p. 5.

1357 For examples of each of these activities, cf. C. GEORGE & J. SCERRI, “Web 2.0. and User-Generated Content : legal challenges in the new frontier”, Journal of Information, Law and Technology, 2007, p. 4 et s.

several pre-existing works to “change something to it/them” before uploading the resulting work on the Internet (we describe this operation in a voluntarily neutral legal way); the threshold could thus sometimes be lower than “a certain amount of creative effort” as in the OECD proposed definition.

Our notion of UGC, for the sake of this Study differs from the one given by the consortium IDATE-TNO-IVIR Report of 2008<sup>1358</sup>. In that other study commissioned by the European Commission, UCC (User-Created-Content) covered content made available not only on the Internet (like for the OECD Study) but included content made available through any telecommunication network and platform; we limit our analysis to the Internet.

We therefore concentrate our analysis on content made available on the internet by a user who modified a pre-existing work before uploading it; it must however be understood that such modification does not require a creative effort and may result from merely adding, subtracting or associating some pre-existing content with other pre-existing content.

UGC certainly has empowered (or has at least given greater power than before to) two new actors in the realm of copyright, apart from the rightholders who have long been there: on one hand, the users, who have also been there from the beginning of the history of copyright but who had remained up until not so long ago almost unnoticed (actually, users became copyright actors when they acquired the means of mass individual copying, first through the audio recorder and then through video recording devices); and on the other hand, the platforms, which have become new major (if not yet the most important) actors and stakeholders in copyright law. Another important phenomenon is that it has transformed the role of users, from passive readers to active commentators and critics, from coach potatoes to active taggers... and it has given users a tremendous tool of potential influence : their work used to remain largely private, it can now in a second be made available worldwide. These changes will have an impact on society which the scope of this Study is too narrow to examine.

### III. Some available figures

There are a few surveys publicly available on the specific concept of UGC<sup>1359</sup> and one must already note, that most available data does not concern UGC as such, but usually encompasses broader uses of the Internet from which only speculation can be drawn on the specific question of UGC.

Furthermore, the concept of UGC in these surveys is either referred as "user-created content" or "user-generated content" or "amateur content", etc., or is analysed as being part of a larger concept which could be the one of "Web 2.0" or the "Internet 2.0", the "participative web", "the social Internet" or the "social media platforms" in a very broad sense. Consequently, when data are available, they cannot be compared easily since they cover various realities<sup>1360</sup>.

In order to undertake a rigorous analysis of the question, the definition adopted for the purpose of this legal study, as explained above, excludes content created “from scratch” by amateurs as well as the mere upload of other’s works by Internet users – whatever the form of such upload. For understandable reasons, it is quite difficult to gather quantitative data covering UGC as defined here, because it would require an investigation of each individual work to determine whether it is a transformative use by a user of existing copyrighted works, or something else.

---

1358 IDATE, TNO & IVIR, User-Created-Content: Supporting a participative Information Society, SMART, 2007/2008, 14.

1359 IDATE, TNO & IVIR, User-Created-Content: Supporting a participative Information Society, SMART, 2007/2008, p. 29. See also the OECD Report, OECD, DSTI/ICCP/IE (2006)7/Final, Working Party on the Information Economy, Participative Web: User Created Content, 12 April 2007, p. 183.

1360 IDATE, TNO & IVIR, User-Created-Content: Supporting a participative Information Society, SMART, op cit., p. 29



A market analysis published by IVIR and IDATE in 2008 already pointed out the difficulties inherent to the gathering of relevant data on User Generated content<sup>1361</sup>.

The study also showed that a limited percentage of Internet users (10%-13%) could be qualified as “creators”<sup>1362</sup>, although the study suggests that such numbers are increasing over time.

Citing an American study conducted in 2006, the IDATE surveys indicates that 18% of Internet users have taken material found online and remixed into a new creation<sup>1363</sup>; such kind of use matches quite closely our definition of UGC.

Another study concerning bloggers suggests that only 15% of bloggers receive additional revenue from their blog, and a tiny 2% consider their blog as their primary source of income<sup>1364</sup>.

Different studies show that content creators represent a small proportion of internet users; however, this proportion is increasing over time and is significantly higher in the youngest groups of the population. However, it does not necessarily mean that the same conclusions may be drawn concerning UGC as defined in this Study. The availability and intensive use by teenagers of mobile phone's cameras to create and share content, for instance, is pointed out as one of the factors explaining the rise of “user created content” by these groups of the population. It does not mean, however, that phone cameras are used to create and share works that incorporate or mix existing materials, which constitutes the heart of “UGC” as defined in this Study (such activities would rather be the creation of new works – when a threshold of sufficient creativity is reached).

An interesting study commissioned by Creative Commons<sup>1365</sup> primarily focused on clarifying the notion of “non-commercial” and its understanding by internet users and creators, gives certain quantitative data about uses of online creation and sharing of works. The study found out that Photos are the most common type of work used, whereas almost half of all users have also used video or film, texts or writing, games, songs or music, and images. Concerning the type of uses of works made on the internet, the study explains that “*Content users also use online content in a variety of ways. 70% have downloaded content just for themselves, while 46% have shared what they downloaded with others. 49% have posted or uploaded content created by others to a blog or website. Others say they have made new works using others' content by incorporating it (13%), or changing or altering it (8%). 8% say they have remixed or mashed up content.*” The underlined sentence is quite interesting for the current Study. Although it does not completely match our definition of UGC, the aggregation of incorporating, altering, remixing and mashing up existing content approaches the concept of UGC taken for the purpose of this Study.

We could not find quantitative data concerning the perception of legal aspects of UGC, as defined in this Study, by the creators of such content. A specific market analysis should be undertaken to determine whether there is a strong attention for copyright issues by users creating and disseminating content on the Internet.

Data concerning actions undertaken by copyright holders against User Generated Content is also hard to find and the few data available does not distinguish between actions against copyrighted content “merely

---

1361 idem., p. 29-30

1362 Which means people publishing a blog or a website, uploading videos or audio they made or writing and publishing articles ; this notion of “creators” could therefore not be assimilated to the notion of creators of UGC as defined in this study

1363 IDATE, TNO & IVIR, User-Created-Content: Supporting a participative Information Society, op cit., p. 86.

1364 TECHNORATI, State of the Blogosphere, 2008, cited by IDATE, TNO & IVIR, User-Created-Content: Supporting a participative Information Society, op cit., p. 107. Since 2008, it is possible however that these figures have evolved.

1365 Creative Commons Corporation, Defining “Noncommercial”. A Study of How the Online Population Understands “Noncommercial Use”, September 2009, available online at [http://wiki.creativecommons.org/Defining\\_Noncommercial](http://wiki.creativecommons.org/Defining_Noncommercial). The percentages add up strangely to more than 100 %, probably because many cases qualify for different categories.

uploaded” on the web platforms and copyrighted content transformed by users, which is primarily considered in the present Study.

#### IV. The Commission’s position on UGC

In the Green Paper on Copyright in the Knowledge Economy<sup>1366</sup>, the Commission considered the issues related to UGC.

The Commission’s view in that Green Paper may be summarized by the following extracts from the Green Paper:

- “The Directive does not currently contain an exception which would allow the use of existing copyright protected content for creating new or derivative works. The obligation to clear rights before any transformative content can be made available can be perceived as a barrier to innovation in that it blocks new, potentially valuable works from being disseminated. However, before any exception for transformative works can be introduced, one would need to carefully determine the conditions under which a transformative use would be allowed, so as not to conflict with the economic interests of the rightholders of the original work”.
- “Under the Berne convention, a transformative use would be *prima facie* covered by the reproduction right and the right of adaptation. An exception to these rights would have to pass the three-step test. In particular, it would have to be more precise and refer to a specific policy justification or types of justified uses. It would also have to be limited to short takings (short passages, excluding particularly distinctive takings), therefore not infringing the right of adaptation”.
- “Under the Directive, certain exceptions potentially provide some measure of flexibility in relation to free uses of works. Other than the previously mentioned exceptions, article 5(3)(d) allows quotations “for purposes such as criticism or review”. Criticism and review are therefore only examples of possible justifications for quotations. This implies that article 5 (3)(d) can be given a broad scope, although the quotation must be limited to “the extent required by the specific purpose”, and in accordance with “fair practice”. The “specific purpose” of the commentary need not be the analysis of the work itself. However, a degree of taking which is fair in a commentary on that particular work may become unfair practice if it is for the purpose of commenting on a wider issue. Another exception allowing some measure of flexibility is article 5(3)(k) of the Directive which exempts uses “for the purposes of caricature, parody or pastiche”. Although these uses are not defined, they allow users to reuse elements of previous works for their own creative or transformative purpose”.

The Commission then called for comments on the two following questions:

- (24) *Should there be more precise rules regarding what acts end users can or cannot do when making use of materials protected by copyright?*
- (25) *Should an exception for user-created content be introduced into the Directive?*

The answers to this consultation were made available on the Commission’s website, but apparently no summary was made (or at least was made available) of the answers received. We did not review all the responses to the Green Paper but a significant part thereof and our analysis is that the answers could be categorized as follows:

---

<sup>1366</sup>Green Paper, Copyright in the Knowledge Economy Brussels, COM (2008) 466/3.

- Representatives of rightholders in their vast majority considered that no new rules were necessary and that no new exception was necessary. In their view, the existing exceptions and the growing number of existing standard licensing schemes (including open access licences and Creative Commons licences) provide sufficient flexibility to cover UGC. In their view, when rightholders are asked to grant permission, they do so at reasonable conditions. UGC was able to flourish in the present legal environment; an exception would benefit commercial intermediaries (such as YouTube), which is not acceptable. A UGC exception would probably be contrary to the 3-steps-test and would undermine the growing – and, to many, desirable – trend of monetization of content;
- Some civil rights organizations and, in general, intermediaries (platforms, access providers, etc.) called for a U.S. style “fair use” approach or, as an intermediate solution, for an exception for transformative works, stating that a UGC exception would greatly encourage users’ self-expression, creativity and access to knowledge. Others asked that the directive be clarified and that the exceptions of article 5.3.d (quotation) and article 5.3.k (caricature and parody) explicitly cover UGC; some pointed out that a UGC exception would increase the credibility and acceptance of copyright by users and by society at large;
- Several respondents (representing various stakeholders) admitted that more guidance would be useful for users, both on what was allowed and what was prohibited.

In its Communication of 19 October 2009 on Copyright in the Knowledge Economy<sup>1367</sup>, which followed the Green Paper, the Commission concluded that the consultation initiated by the Green Paper showed that “most of the stakeholders consider that it is too early to regulate UCC” and announced that the Commission would further investigate the specific needs of non-professionals that rely on protected works to create their own works and further consult on solutions for easier, more affordable and user-friendly rights clearance for amateur users.

In its Communication of 24 May 2011 “on a Single Market for Intellectual Property Rights Boosting creativity and innovation to provide economic growth, high quality jobs and first class products and services in Europe”, the Commission returned to the issue of UGC and stated the following:

- *“specific attention will be given to possible approaches to deal with so called user-created or user-generated content (UGC). In line with its overall approach, the Commission advocates responsible use while ensuring that users enjoy the full benefits of new interactive online services”*,
- *“There is a growing realisation that solutions are needed to make it easier and affordable for end-users to use third-party copyright protected content in their own works. Users who integrate copyright-protected materials in their own creations which are uploaded on the internet must have recourse to a simple and efficient permissions system. This is particularly pertinent in the case of “amateur” users whose UGC is created for non-commercial purposes and yet who face infringement proceedings if they upload material without the right holders’ consent. The time has come to build on the strength of copyright to act as a broker between rights holders and users of content in a responsible way. The Commission will explore the issue further, including via contacts with all interested parties notably in the context of the above mentioned dialogue with stakeholders, in order to strike a balance between the rights of content creators and the need to take account of new forms of expression”*.

---

1367 COM (2009) 532 final, p. 9.

The Commission further announced its position in its recent Communication of December 18, 2012 on Content in the Digital Single Market<sup>1368</sup>, as follows:

**(ii) User-generated content and licensing for small-scale users of protected material**

- *“The Commission's objective is to foster transparency and ensure that end-users have greater clarity on legitimate and non-legitimate uses of protected material, and easier access to legitimate solutions. Content generated by users themselves is often covered by some form of licensing by rights holders, in partnership with certain platforms. However the scale and coverage of such licences is not transparent to the end user. Furthermore, such arrangements create rights and obligations for the contractual partners, but do not necessarily provide legal certainty to the end-users. In parallel, small-scale users of content, such as small companies who wish to use some images or music in their websites, struggle to identify how to acquire licences for low value uses of protected content.*
- *This work strand should identify the extent to which user-generated content is licensed to relevant platforms, and identify how to ensure that end-users are informed about what is legal and illicit use on the internet.*
- *It should seek to ensure that end users benefit from easier access to, and greater clarity on what are the legitimate and non legitimate uses of protected material. To that effect, it should identify the range and extent of "one-click" licensing initiatives in the EU, deliver solutions to extend the development and interconnection of such initiatives and explore the appropriateness of licensing or appropriate terms – e.g. the possibility of free licenses”.*

Even if we shall not deal with liability of operators on the Internet, one should finally also mention the Commission's work in the context of the revision of the e-Commerce directive<sup>1369</sup>. It is worth mentioning that, in this context, the “notice and take down” procedures are one of the topics of the consultation by the Commission (we will come back to this later).

## V. Which exclusive rights are at stake ?

UGC involves altogether (1) the reproduction right, (2) the communication to the public right (except where the UGC work is only made available to a limited group of friends or relations), including the right to make available and (3) the adaptation right.

### A. The reproduction right

UGC as we understand it in this Study involves the reproduction right. The reproduction right is indeed defined in the InfoSoc Directive in a very broad and encompassing manner (article 2) as:

*“the exclusive right to authorise or prohibit direct or indirect, temporary or permanent reproduction by any means and in any form, in whole or in part” (for authors, of their works; for performers, of fixations of their first performances, etc.).*

The reproduction right is recognized by all the treaties on copyright and related rights; it is not necessary to elaborate on the importance of this right and on its strong relationship with the adaptation right<sup>1370</sup>.

---

1368 Communication of December 18, 2012 on Content in the Digital Single Market, Brussels, 18.12.2012, COM(2012) 789 final

1370 See on this, M. Ficsor, “Comments on the UGC provisions in the Canadian Bill C-32: potential dangers for unintended consequences in the light of the international norms on copyright and related rights” (23 October 2010), available at [http://www.copyrightseesaw.net/archive/?sw\\_10\\_item=31](http://www.copyrightseesaw.net/archive/?sw_10_item=31), p. 2.

According to a number of commentators, the very wide definition given by the InfoSoc Directive implies that “the right of reproduction covers virtually any use of a work or other subject matter, even where similar acts of use in the analogue world (such as receiving television signal or reading a book) would fall well outside the scope of what intellectual property aims to protect”<sup>1371</sup>; without going further on this controversy, one must at the same time remember that a (compulsory) exception has been provided for by the InfoSoc Directive for technical acts of reproduction (article 5.1. of the Directive). It is therefore clear that the reproduction right is involved in UGC as we understand it<sup>1372</sup>. There will always be at least a “reproduction in part” in any User Generated Content since the user will start from a pre-existing work to generate a new/modified version of said work. The Infopaq I decision of the CJEU reinforces this analysis, in confirming that copying eleven words in a sentence (more precisely in the title of a newspaper article) may amount to a “reproduction in part”.

This implies that, in every situation where the pre-existing work is a work (still) protected by copyright, an authorization covering the user’s activities will be necessary, unless an exception to the reproduction right applies. Apart from the exceptions, there may arguably be some notion of “*de minimis*”: copying and remixing (etc) very small amounts may not always suffice to engage either the reproduction or the adaptation rights<sup>1373</sup>.

## **B. The communication to the public right, including the right to make available**

Uploading UGC on a Web platform on site, whether for commercial purposes or not, amounts clearly to communication such UGC to the public and/or making such UGC available in the sense of article 3 of the InfoSoc Directive which defines communication to the public as follows:

*“the exclusive right to authorise or prohibit any communication to the public of their works, by wire or wireless means, including the making available to the public of their works in such a way that members of the public may access them from a place and at a time individually chosen by them”*,

*(For authors, of their works – see article 3.1.; for performers, of the first fixations of their performances – see article 3.2.; etc.).*

It is therefore clear that making UGC available on a website or a platform amounts to communicating it to the public and/or making it available to the public in such a way that members of the public may access them from a place and at a moment individually chosen by them<sup>1374</sup>.

Consequently, doing so requires (as for the reproduction right) that, in every situation where the pre-existing work is a work (still) protected by copyright, an authorization covering the user’s activities will be necessary, unless an exception applies<sup>1375</sup>. This would be the case if the communication only takes in a family circle, but in most cases, the UGC will be uploaded on a platform and thus be made available to “the public” and not just to a family circle.

---

1371 See, for instance, IDATE, TNO & IVIR, User-Created-Content: Supporting a participative Information Society, SMART, 2007/2008, p. 187 and the references mentioned there.

1372 In the same sense, M. Ficsor, op. cit., p. 2.

1373 On the “*de minimis*” argument, see *infra* in this report.

1374 In this sense, M. Ficsor, “Comments on the UGC provisions in the Canadian Bill C-32: potential dangers for unintended consequences in the light of the international norms on copyright and related rights” (23 October 2010), available at [http://www.copyrightseesaw.net/archive/?sw\\_10\\_item=31](http://www.copyrightseesaw.net/archive/?sw_10_item=31), p. 8.

1375 In this sense, IDATE, TNO & IVIR, User-Created-Content: Supporting a participative Information Society, SMART, 2007/2008, p. 187.

### C. The right of adaptation

The Berne Convention provides for an exclusive right for authors to authorize adaptations of their works. Article 12 of the Berne Convention (under the title “Right of Adaptation, Arrangement and Other Alteration”) defines such right in a rather broad manner as follows:

*“Authors of literary or artistic works shall enjoy the exclusive right of authorizing adaptations, arrangements and other alterations of their works.”*

The Berne Convention does not explicitly authorize Member States to provide for exceptions to the adaptation right but it is generally recognized that they may provide for an exception for parodies and caricatures, which are then to be considered as “excused adaptations”<sup>1376</sup>.

Contrary to the reproduction right and the public communication right, the adaptation right has not been harmonized by the InfoSoc Directive. Such right has only been harmonized in the Software Directive and in the Database Directive.

The Software Directive, under article 4 (b) defines it very broadly as follows:

*“(b) the translation, adaptation, arrangement and any other alteration of a computer program and the reproduction of the results thereof, without prejudice to the rights of the person who alters the program”.*

The Database Directive, under article 5 (b) defines it also very broadly as follows:

*“(b) translation, adaptation, arrangement and any other alteration”*

and the Database Directive further grants to the authors of databases the following exclusive right under article 5 (e):

*“(e) any reproduction, distribution, communication, display or performance to the public of the results of the acts referred to in (b).”*

Except for computer programs and databases, it may therefore be argued (but this is not agreed by all) that the adaptation right is not part of the *acquis communautaire* on copyright<sup>1377</sup>. However, since all Member States of the EU are also Members of the Berne Convention, they all provide for such an exclusive adaptation right for the authors, even if such right has not been harmonized<sup>1378</sup>. Whether the adaptation right (for works) and the fact that it is arguably not part of the *acquis* could serve as valid grounds to introduce a UGC exception will be analyzed in the second part of our Study, devoted to possible solutions for UGC.

1376 S. Ricketson & J. Ginsburg, *International copyright and Neighboring Rights*, Oxford University Press, 2005, p. 483-484, as quoted by M. Ficsor, “Comments on the UGC provisions in the Canadian Bill C-32: potential dangers for unintended consequences in the light of the international norms on copyright and related rights” (23 October 2010), available at [http://www.copyrightseesaw.net/archive/?sw\\_10\\_item=31](http://www.copyrightseesaw.net/archive/?sw_10_item=31), p. 5.

1377 P.B. Hugenholtz & R.F. Senftleben, *Fair Use in Europe*. In search of Flexibilities, Amsterdam, November 2011, p.2, and p. 26; M. Senftleben, *Quotations, Parody and Fair Use*, available at [http://papers.ssrn.com/sol3/papers.cfm?abstract\\_id=2125021](http://papers.ssrn.com/sol3/papers.cfm?abstract_id=2125021), p. 384 et s.; Response of IVIR to the Green Paper on Copyright in the Knowledge Economy, p. 6.

1378 The WIPO Treaty does not explicitly deal with the adaptation right; in its article 1, it simply states that “Contracting Parties shall comply with Articles 1 to 21 of the Berne Convention” (which thus includes article 12 of the Berne Convention on the adaptation right, as does the TRIPS Agreement (article 9.1.) when referring also to the obligation of the Members to comply with Articles 1 through 21 of the Berne Convention (thereby also including article 12 on the adaptation right).

UGC as we understand it in this Study clearly involves the adaptation right, every time the pre-existing work is a copyright protected work, since the user will, in some way, arrange the work or modify it<sup>1379</sup>. Remixes, mash-ups, samplings, etc. all amount to an adaptation of the underlying work, except that there may be some notion of “*de minimis*”: copying and remixing (etc) very small amounts may not always suffice to engage either the reproduction or the adaptation rights.

Consequently, for creating UGC, an authorization covering the user’s activities will be necessary, unless an exception to the adaptation right applies<sup>1380</sup>. An example given by M. Ficsor (and which is a typical UGC case) is the case where a musical work is the object of an audiovisual adaptation (making a recording of a member of a family dancing on the sound recording of the performance of a musical work): “*For such acts – unless covered by an exception – the authorization of the author of the original work is needed, irrespective of whether his right is characterized as right of adaptation or right of reproduction*”<sup>1381</sup>. Unless the use of such adaptation only takes place in a family circle, the authorization of the rightholder is required.

This raises questions regarding UGC. Some of the difficulties of the approach are that the scope of the adaptation right as such has given rise to less analysis by commentators, that the delineation between the reproduction right and the adaptation right on one hand and the dividing line between the adaptation right and the moral right of integrity are sometimes hard to draw, and that, contrary to other exclusive rights, no clear guidance exists as to which exceptions could be provided to the adaptation right by national legislators.

As a **summary** – and we think that most commentators will agree with it and that this will not give rise to much debates - UGC falls under the scope of altogether the reproduction right, the public communication/making available right and the (not harmonized) adaptation right. So, unless an exception can be invoked, a licence from the rightholder(s) is necessary<sup>1382</sup> when the UGC relies in copying parts of pre-existing works and is communicated to the public.

## VI. Which moral rights are at stake?

There are few international provisions aiming at harmonizing moral rights. Article 6bis of the Berne Convention, article 5 of the WIPO Performances and Phonograms Treaty of 1996 and article 5 of the Beijing Treaty on Audiovisual Performances (adopted in 2012) provide a minimal ground of moral rights for, respectively, authors and performers, while the other WIPO copyright treaty, the TRIPS and the European directives on copyright exclude moral rights from their scope. As moral rights are clearly out of the current scope of the EU legal instruments analyzed in this Study, we will not grant extensive attention to this question.

A first remark worth making is the lack of harmonization of moral rights. The Berne Convention sets out a minimal standard of moral rights which includes the right of attribution and the right of an author to object derogatory action in relation to its work, which would be prejudicial to his honour or reputation. The

---

1379 In the same sense, M. Ficsor, “Comments on the UGC provisions in the Canadian Bill C-32: potential dangers for unintended consequences in the light of the international norms on copyright and related rights” (23 October 2010), available at [http://www.copyrightseesaw.net/archive/?sw\\_10\\_item=31](http://www.copyrightseesaw.net/archive/?sw_10_item=31), p. 3.

1380 See in this sense, IDATE, TNO & IVIR, User-Created-Content: Supporting a participative Information Society, SMART, 2007/2008, p.188.

1381 M. Ficsor, “Comments on the UGC provisions in the Canadian Bill C-32: potential dangers for unintended consequences in the light of the international norms on copyright and related rights” (23 October 2010), available at [http://www.copyrightseesaw.net/archive/?sw\\_10\\_item=31](http://www.copyrightseesaw.net/archive/?sw_10_item=31), p. 7.

1382 In the same sense, IDATE, TNO & IVIR, User-Created-Content: Supporting a participative Information Society, SMART, 2007/2008, p.196.

implementation of these rights may vary across the countries and, furthermore, certain countries recognise additional moral rights (for instance, the “*droit de repentir*” in France).

One could, however, find some traces of the right of attribution in directive 2001/29. The benefit of the exceptions for illustration of teaching and scientific research (art. 5.3.a), for reproduction by the press (art. 3.3.c), for quotation (art.3.3.d) and for the use of political speeches (art.3.3.f) is only granted if the source, including the author’s name, is indicated by the user of the works<sup>1383</sup>. The Court has recently emphasized the notion of “indication of the source”<sup>1384</sup> in relation to the exception of quotation, as well as it provided its own interpretation of certain material aspects of this condition. One could therefore argue, even if the Court did not state it explicitly, that indication of the source, in the field of the copyright directive, is an autonomous concept of EU law, which must receive uniform interpretation across the Member States.

We are certainly not claiming here that such condition constitutes some “stealth harmonization” of the moral right of attribution. However, although moral rights stay clearly outside the scope of the directive, the condition of attribution in certain exceptions seems to overlap the moral right concerned. Consequently, and given the lack of harmonization of the moral rights in general and the right of attribution in particular, one could argue that the condition of acknowledgement of the source constitutes, as a matter of fact, a uniform implementation of the right of attribution in the field of these exceptions.

For this Study on User Generated Content, it can therefore be sustained that the right of attribution does not constitute an additional legal issue to take into account insofar as such UGC is covered by an exception which requires indication of the source. The exception of quotation, in particular, may be invoked in several cases of UGC (see *infra*) and its conditions include in practice the right of attribution.

The issue of the moral right of attribution remains, however, concerning User Generated Content which may be covered by other exceptions (existing or to be added in the future). For instance, the directive does not require the indication of the source in the exception of parody (probably because in a parody the source is well known – or the parody risks to remain unnoticed). In this regard, various interpretations may arise across the Member States and the moral right of attribution could possibly interfere with the reproduction and/or the communication to the public of works covered by such exceptions. Authors have furthermore pointed out the practical difficulties of indicating the source of the original work in the context of a parody of said work, without creating any misleading impression that the original author created or approved such parody<sup>1385</sup>.

The moral right of integrity (the right to object derogatory action) is regularly cited as a potential obstacle to the enjoyment of exceptions and limitations to copyright<sup>1386</sup>. Indeed, the interpretation of the scope of this right receives various interpretations across different states. While the USA have taken a minimalistic approach, countries like France give a more substantial content to the right of integrity. For instance, the disassociation of the words and music of a sound recording so that it could be used for karaoke has been found to infringe the author’s right of integrity in France<sup>1387</sup>, which would arguably not be the cases in countries where an artist would need to establish that such use of its work was prejudicial to his or her honour or reputation.

---

1383 It is on the basis of this reasoning that S. Ricketson and J. Ginsburg infer an attribution right in the Berne Convention.

1384 CJUE, 1 December 2011, C-145-10, Painer

1385 M. Sainsbury, “Parody, satire, honour and reputation: The interplay between economic and moral rights”, AIPJ, 2007, p. 149, Electronic copy available at: <http://ssrn.com/abstract=1980392>

1386 M. Sainsbury, “Parody, satire, honour and reputation”, op. cit ; M. Ficsor, “Comments on the UGC provisions in the Canadian Bill C-32: potential dangers for unintended consequences in the light of the international norms on copyright and related rights” (23 October 2010), available at [http://www.copyrightseesaw.net/archive/?sw\\_10\\_item=31](http://www.copyrightseesaw.net/archive/?sw_10_item=31) ; Robert C. Bird and Lucille M. Ponte, “Protecting moral rights in the United States and the United Kingdom: Challenges and opportunities under the U.K.’s new performances regulations”, Boston University International Law Journal, vol. 24:213, 2006, p. 214. Yet one may notice that France has both a strong right of integrity and an exception of parody, so that this “obstacle” may be overstated.

1387 See Editions Zagora c SDRM, CA Paris, 4 ch, 29 May 2002 (2002) 194 RIDA 325.



The moral right of integrity may therefore, in certain cases and probably more in certain countries than in others, constitute an obstacle to the enjoyment of actual or potential exceptions allowing the creation and the communication to the public of UGC based on copyrighted materials.

## VII. Which exceptions from the InfoSoc Directive are relevant?

The Terms of Reference do invite us to examine which exceptions from the closed list of the InfoSoc Directive may be relevant for UGC and<sup>1388</sup> mention: quotation for purposes such as criticism or review, incidental inclusion, and the caricature, parody and pastiche exception.

The applicability (or not) of existing exceptions to UGC is probably, with the issues related to the liability of content-sharing platforms, the most debated issue when discussing the legal rules applicable to UGC.

To begin with, one should mention that the InfoSoc Directive does not provide for an exception for UGC as such; this is quite understandable as UGC was far from being as ubiquitous in 2001 than it is now, but this is why one must look at the other exceptions in order to see which one(s), if any, may be relevant for UGC.

The case for a specific UGC exception is supported by some. We will discuss it in the second part of our Study, together with the other solutions which we think could be put in place, if the need to support the development of UGC was established.

We will describe hereafter why the applicability of existing exceptions to UGC is partly unclear and cannot, at least in their current formulation and implementation in the Member States, serve, if they are not adapted, as a sufficient ground to sufficiently insulate UGC from copyright claims<sup>1389</sup>.

### A. Quotation for criticism or review

#### 1. General presentation

Article 5.3.d of the InfoSoc Directive allows Member States to provide for an exception or a limitation to the rights provided for in Articles 2 and 3 (i.e. the reproduction right and the public communication right) in the following case:

*“(d) quotations for purposes such as criticism or review, provided that they relate to a work or other subject-matter which has already been lawfully made available to the public, that, unless this turns out to be impossible, the source, including the author's name, is indicated, and that their use is in accordance with fair practice, and to the extent required by the specific purpose”.*

The formulation of this exception is partly broad (“such as criticism or review”) and partly rather narrow, as it is accompanied by many conditions (“provided that “, with four conditions attached which must be understood as cumulative). The exception is optional for Member States, which are free to implement it or not (subject to what the Court has stated in this regard in the Painer case – see elsewhere in this Study).

---

1388 Private copying is out of scope of this study and is at first sight of little relevance, to at least the great majority of UGC publicly (i.e. not “privately”) available on the Web.

1389 In the same sense, note by S. Dusollier, “The relations between copyright law and consumers’ rights from a European perspective”, for the European Parliament, DG for Internal policies, November 2010, p. 15.

The quotation exception was already proposed by the Commission in its draft directive (which was suggesting a shorter list of eight optional exceptions), as follows:

*"(d) quotations for purposes such as criticism or review, provided that they relate to a work or other subject matter which has already been lawfully made available to the public, that the source is indicated, and that their use is in accordance with fair practice, and to the extent required by the specific purpose;"*

The drafting changed only slightly during the legislative process, on the issue of the mention of the author's name (and not only "the source"), whenever that was possible. This is an indication that the exception did not cause too much controversy.

It may be useful to remember that this exception for quotation is explicitly allowed by the Berne Convention, which states as follows:

"Article 10 Certain Free Uses of Works: 1. Quotations; (...) 3. Indication of source and author

*(1) It shall be permissible to make quotations from a work which has already been lawfully made available to the public, provided that their making is compatible with fair practice, and their extent does not exceed that justified by the purpose, including quotations from newspaper articles and periodicals in the form of press summaries.*

*(...)*

*(3) Where use is made of works in accordance with the preceding paragraphs of this Article, mention shall be made of the source, and of the name of the author if it appears thereon."*

How has this optional exception been implemented by the Member States?

Without going into detail on this implementation (which would fall outside the scope of this Study), one should mention the following when analysing the implementation of the right of quotation in the Member States<sup>1390</sup>.

## 2. Implementation of the exception in the Member States:

In light of the Painer decision of the CJUE, it seems to us rather clear that some implementation legislations and/or interpretations prevailing in certain Member States may need to be revisited, as the Court in that decision has brought some light on certain issues yet casted some doubts about some others.

**Austria:** quotations have **long been allowed** by the Copyright Act, so that no amendment was brought to it when implementing the Directive.

**Belgium:** quotations **are allowed** from works which have been lawfully published, for the purposes of criticism, debate, review, education or in scientific works, in conformity with fair professional uses and insofar as justified by the purpose, with mention of the source and of the name of the author, unless this proves impossible. Quotations in political propaganda or meant mainly for commercial purposes are not

---

<sup>1390</sup> The following summary is based on the following reports: Copyright in the information society – A Guide to National Implementation of the European Directive, edited by B. Lindner & T. Shapiro, Edward Elgar Publishing Ltd, 2011; Institute for Information Law (IVIR), Study on the implementation and effect in Member States' laws of Directive 2001/29/EC on the harmonization of certain aspects of copyright and related rights in the information society, Part II, Country reports, G. Westkamp, Final report, February 2007.

allowed. Quotations must be a part of a wider work and cannot just be used as teasers or to attract the public's attention<sup>1391</sup>.

**Bulgaria:** the quotation exception **has been extended**, to cover not only works in printed form but also works already communicated to the public, "that is, those that have been communicated on radio and TV"<sup>1392</sup>. One may expect that this also covers works communicated to the public via the internet but this does not seem to be obvious. There is a court case going on about whether the repeated broadcasting of TV blunders in a TV talk show fits within the exception (particularly because the TV blunder is shown more than once, to make it sound even funnier).

**Cyprus:** the quotation right (in Article 7.2.6. of the Copyright Act) **seems to be included** in a broader exception covering "carrying out of acts in good faith for the purpose of research, private use, critical review or reporting on current events on condition that the author's name is acknowledged if such is made in public"<sup>1393</sup>. It seems to us that the text does not follow very strictly the quotation exception as provided for the InfoSoc Directive. The purposes are not restricted to criticism or review but must not conflict with honest practice.

**Czech Republic:** the quotation rights **seem to be broader than allowed by the Directive**. It already existed before implementation of the Directive but article 31 (1) (b) of the Copyright Act also allows the use, to a justified extent, in an own individual work, of excerpts from works of other authors which have been made public. Article 31 (1) (a) allows short quotations, in accordance with general interests, but not just for the purposes explicitly listed in the quotation exception of the Directive but also for other purposes (such as artistic or humorous). Article 31 (1) (b) allows for substantial quotations e.g. small works in their entirety), but then only for critique or review related to the work or for the purpose of scientific or technical work<sup>1394</sup>. There is no indication that the source must have been lawfully made available<sup>1395</sup>.

**Denmark:** Section 22 of the Danish Copyright Act provides that a person **may quote** from a work which has been made public in accordance with proper usage and to the extent required for the purpose<sup>1396</sup>.

**Estonia:** Article 19 of their Copyright Act **authorizes summaries and quotations** from a work that has been lawfully made available to the public, provided that its extent does not exceed that justified by the purpose and the idea of the work as a whole which is being summarized or quoted is conveyed correctly<sup>1397</sup>.

1391 M.C. Janssens, in *La loi belge sur le droit d'auteur. Commentaire par article, Hommage à Jan Corbet, Larquier, ed. F. Brison & H. Vanhees*, 3rd ed., p. 139. See in Belgium the *Copiepresse v. Google* case, where the Court of appeal of Brussels denied the application of quotation to GoogleNews.

1392 Copyright in the information society – A Guide to National Implementation of the European Directive, edited by B. Lindner & T. Shapiro, Edward Elgar Publishing Ltd, 2011 (chapter on Bulgaria by V. Sokolov, p. 110).

1393 Copyright in the information society – A Guide to National Implementation of the European Directive, edited by B. Lindner & T. Shapiro, Edward Elgar Publishing Ltd, 2011 (chapter on Cyprus by A. Demetriades), p. 128; Institute for Information Law (IVIR), Study on the implementation and effect in Member States' laws of Directive 2001/29/EC on the harmonization of certain aspects of copyright and related rights in the information society, Part II, Country reports, G. Westkamp, Final report, February 2007, p. 142.

1394 For a more detailed presentation of the intricate Czech system on quotations, see Copyright in the information society – A Guide to National Implementation of the European Directive, edited by B. Lindner & T. Shapiro, Edward Elgar Publishing Ltd, 2011 (chapter on Czech Republic by L. Pressburgerova & J. Tajbr), p. 144 and 145.

1395 Institute for Information Law (IVIR), Study on the implementation and effect in Member States' laws of Directive 2001/29/EC on the harmonization of certain aspects of copyright and related rights in the information society, Part II, Country reports, G. Westkamp, Final report, February 2007, p. 152.

1396 Copyright in the information society – A Guide to National Implementation of the European Directive, edited by B. Lindner & T. Shapiro, Edward Elgar Publishing Ltd, 2011 (chapter on Denmark by P. Schonning), p. 168; Institute for Information Law (IVIR), Study on the implementation and effect in Member States' laws of Directive 2001/29/EC on the harmonization of certain aspects of copyright and related rights in the information society, Part II, Country reports, G. Westkamp, Final report, February 2007, p. 162.

1397 Copyright in the information society – A Guide to National Implementation of the European Directive, edited by B. Lindner & T. Shapiro, Edward Elgar Publishing Ltd, 2011 (chapter on Estonia by V. Naslund), p. 180.

**Finland:** according to Article 22 of the Copyright Act, a work made public **may be quoted**, in accordance with proper usage to the extent necessary for the purpose; according to Article 25.1, works of art made public may be reproduced in pictorial form in material connection with the text in a critical or scientific presentation<sup>1398</sup>. Article 25.1. therefore allows more than just a quotation (i.e. a copy of a part of a work) but a reproduction of the whole work (yet is limited to published works of art).

**France:** Article L. 122.5.3. of the Code on Intellectual Property **allows**, for works which have been lawfully divulged, **analyses and short quotations** justified by the character of the work in which the quotation must be incorporated, being criticism, debate, education, scientific or informational. This clearly means that quotations must remain short and can only be made in the context of a wider work incorporating them<sup>1399</sup>. Because quotations must be short, it is often understood that it does not apply to works of visual arts (a quotation of which can hardly be “short”)<sup>1400</sup>. There is however some case law which accepts that the exception also applies to works of visual arts or to musical ones, the sole limitation being that the quotation remains short.

**Germany:** the quotation right **already existed and is included** in Section 51 (“Quotations”) of the Copyright Act<sup>1401</sup>, which provides that “reproduction, distribution and communication to the public shall be permitted, to the extent justified by the purpose, where

1. individual works are included after their publication in an independent scientific work to illustrate its contents;
2. passages from a work are quoted after its publication in an independent work of language;
3. individual passages from a published musical work are quoted in an independent musical work<sup>1402</sup>.

According to Section 63, the source must in all cases be clearly acknowledged, except if it proves impossible.

**Greece:** Greek law **already provided for a quotation exception** and it was not changed when the legislator implemented the InfoSoc Directive<sup>1403</sup>. The wording talks about “short extracts” of a lawfully published work for the purpose of providing support for a case advanced by the person making the quotation or a critique of the position of the author (of the work being quoted); this is allowed provided it is compatible with fair practice and limited to what is necessary. The name of the author must be mentioned if it was mentioned on the work being quoted<sup>1404</sup>.

---

1398 Copyright in the information society – A Guide to National Implementation of the European Directive, edited by B. Lindner & T. Shapiro, Edward Elgar Publishing Ltd, 2011 (chapter on Finland by K. Harenko), p. 191.

1399 Copyright in the information society – A Guide to National Implementation of the European Directive, edited by B. Lindner & T. Shapiro, Edward Elgar Publishing Ltd, 2011 (chapter on France by P. Kamina), p. 213.

1400 Institute for Information Law (IVIR), Study on the implementation and effect in Member States' laws of Directive 2001/29/EC on the harmonization of certain aspects of copyright and related rights in the information society, Part II, Country reports, G. Westkamp, Final report, February 2007, p. 213.

1401 Copyright in the information society – A Guide to National Implementation of the European Directive, edited by B. Lindner & T. Shapiro, Edward Elgar Publishing Ltd, 2011 (chapter on Germany by M. Schaefer), p. 223.

1402 The translation is from WIPO.

1403 Institute for Information Law (IVIR), Study on the implementation and effect in Member States' laws of Directive 2001/29/EC on the harmonization of certain aspects of copyright and related rights in the information society, Part II, Country reports, G. Westkamp, Final report, February 2007, p. 248.

1404 Copyright in the information society – A Guide to National Implementation of the European Directive, edited by B. Lindner & T. Shapiro, Edward Elgar Publishing Ltd, 2011 (chapter on Greece by E. Vagena), p. 242.

**Hungary:** Article 34.1. of the Copyright Act implements the quotation right in accordance with the text of the InfoSoc Directive<sup>1405</sup>. **Quotations are permitted** provided that the source is indicated, that the extent of the quotation is justified by the nature and purpose of the use of the work quoted and that it does not modify the quoted work<sup>1406</sup>. Expert opinion 22/2009 of the Hungarian Copyright Expert Board emphasized that in case the translator adds a quote from a former translation of the work into his new translation, but modifies the cited segment to “fit it into” the new translation (whilst she refers to this fact in a footnote), one cannot speak about a legal quotation, since the Copyright Act protects only those users who do not modify the original work.

**Ireland :** Section 51 of the Copyright Act **allows the use of a work for criticism or review**, on condition that the dealing is a “fair dealing” (see more explanation on this hereafter) and with acknowledgment of the source. This is considered as coming very close to the text of the InfoSoc Directive<sup>1407</sup>. Section 52.4 of the Copyright Act further provides for a general exception for “quotations and extracts”, provided acknowledgment of the source and provided that this does not prejudice the interests of the copyright owner. This last condition has not yet been examined by Irish Courts; commentators tend to assimilate this to the condition that the use be a “fair dealing”.<sup>1408</sup> *“Fair dealing” is traditionally available for three distinct types of uses: research or private study, criticism or review and for reporting current events. Defining what fair dealing is proves difficult, as illustrated by Lord Denning in the landmark case of Hubbard & Anor v Vosper & Anor: “It is impossible to define what is ‘fair dealing’. It must be a question of degree. You must consider first the number and extent of the quotations and extracts. Are they together too many and too long to be fair? Then you must consider the use made of them. If they are used as a basis for comment, criticism or review, that may be fair dealing. If they are used to convey the same information as the author, for a rival purpose, that may be unfair. Next, you must consider the proportions. To take long extracts and attach short comments may be unfair. But, short extracts and long comments may be fair. Other considerations may come to mind also. But, after all is said and done, it must be a matter of impression”*<sup>1409</sup>.

**Italy:** The abridgment, quotation or reproduction of fragments or parts of a work or their communication to the public for purposes of criticism or discussion **are exempted from copyright** within the limits of such purposes. Quotations may also be made for teaching or research, but they must then have the sole purpose of illustration, with no commercial intent (this latter condition has been introduced when implementing the Copyright Directive and did not exist under the former Copyright Act)<sup>1410</sup>. This means that, as a general rule, quotations of copyrighted works having no connection to a specific discussion, to

1405 Copyright in the information society – A Guide to National Implementation of the European Directive, edited by B. Lindner & T. Shapiro, Edward Elgar Publishing Ltd, 2011 (chapter on Hungary by M. Ficsor), p. 264.

1406 Institute for Information Law (IVIR), Study on the implementation and effect in Member States’ laws of Directive 2001/29/EC on the harmonization of certain aspects of copyright and related rights in the information society, Part II, Country reports, G. Westkamp, Final report, February 2007, p. 261. For an example on quotation and sampling, see the expert opinion 33/2004 of the Hungarian Copyright Expert Board. In that case, the experts had to express their opinion on two sound recordings (SR); generally due to looping the original SR in the second SR, approximately 50% of the second SR was based upon the first SR. The expert opinion concluded that this amount exceeds the limit of quotation. No evidence was submitted in respect of the designation of the author, that is, whether the cover of the CD (of the second SR) referred to the original SR or not.

1407 Copyright in the information society – A Guide to National Implementation of the European Directive, edited by B. Lindner & T. Shapiro, Edward Elgar Publishing Ltd, 2011 (Chapter on Ireland, by L. Scales, p. 287.

1408 Idem.

1409 Lord Denning as quoted by L. Scales, op. cit., p. 286.

1410 Copyright in the information society – A Guide to National Implementation of the European Directive, edited by B. Lindner & T. Shapiro, Edward Elgar Publishing Ltd, 2011 (Chapter on Italy, by S. Ercolani), p. 309. The Italian Supreme Court has made it clear that quotations should be limited to parts of works, so as not to expropriate the authors of their rights of exploitation; S. Ercolani, eod. loco, p. 309; Institute for Information Law (IVIR), Study on the implementation and effect in Member States’ laws of Directive 2001/29/EC on the harmonization of certain aspects of copyright and related rights in the information society, Part II, Country reports, G. Westkamp, Final report, February 2007, p. 289.

criticism, or to an educational session, as in the case of anthologies or reproductions with purely illustrative purposes, are not considered legitimate without proper authorization.<sup>1411</sup>

**Latvia:** Quotations of fragments of works **are allowed** by Section 19.1. of the Copyright Act, for informational purposes, which must be interpreted as only for the purposes of scientific, research, polemical or critical purposes, to the extent justified by such purpose<sup>1412</sup>.

**Lithuania:** the quotation exception **appears to narrow the wording of the exception** in the InfoSoc Directive, as it only allows the reproduction of “relatively short passages” of works, in the form of a quotation in another work, in conformity with fair practice and limited to what is necessary for the purpose<sup>1413</sup>. The author and source must be indicated.

**Luxembourg: short quotations (and their translations) are allowed** if justified by the critical, polemical, pedagogical, scientific or informative character of the work in which the quotation is incorporated. Quotations must further be made in accordance with fair practice, not pursue a profitable aim, be required by a specific purpose and not adversely affect the work or its exploitation. It was envisaged to enlarge the exception to “quotations” rather than to “short quotations” but this was rejected. A decision by the Luxembourg Court of appeal decided that seven quotations from a book of 300 pages fulfilled this condition<sup>1414</sup>. Commentators agree that the “short” character is a matter of case-by-case evaluation, taking into account both the quotation and the overall size of the work from which the quotation is made<sup>1415</sup>.

**Malta:** according to Article 9.k of the Copyright Act, which basically follows the wording of the InfoSoc Directive, **quotations as excluded from the scope of the exclusive rights** by the following provision: *“the reproduction, translation, distribution or communication to the public of quotations for purposes such as criticism or review, provided that they relate to a work or other subject-matter which has already been lawfully made available to the public, as long as, unless this is impossible, the source, including the author’s name, is indicated, and that their use is in accordance with fair practice, and to the extent required by the specific purposes”*<sup>1416</sup>.

**The Netherlands:** exceptions to copyright have long been a favorite topic of debate amongst scholars in the Netherlands. Before the Directive was adopted, the Dutch Supreme Court (in the Dior/Evora case) had accepted that exceptions to copyright could, to some extent, be applied by analogy, on the basis of a

1411 See Court of Milan, 05/10/1993, *Il Diritto di Autore*, 1994, p. 603. See also G. Mazziotti, “Copyright and educational uses: the unbearable case of Italian law from a European and comparative perspective”, European University Institute, working paper, available at:

[http://cadmus.eui.eu/bitstream/handle/1814/19697/LAW\\_2011\\_17\\_Mazziotti.pdf](http://cadmus.eui.eu/bitstream/handle/1814/19697/LAW_2011_17_Mazziotti.pdf).

1412 Copyright in the information society – A Guide to National Implementation of the European Directive, edited by B. Lindner & T. Shapiro, Edward Elgar Publishing Ltd, 2011 (Chapter on Latvia, by J. Bordans & I. Veiksa), p. 329.

1413 Copyright in the information society – A Guide to National Implementation of the European Directive, edited by B. Lindner & T. Shapiro, Edward Elgar Publishing Ltd, 2011 (Chapter on Lithuania, by G. Ramanauskas), p. 352. Institute for Information Law (IVIR), Study on the implementation and effect in Member States’ laws of Directive 2001/29/EC on the harmonization of certain aspects of copyright and related rights in the information society, Part II, Country reports, G. Westkamp, Final report, February 2007, p. 316.

1414 Cour d’appel de Luxembourg, 28 February 1913, Pas., VIII, p. 439.

1415 Copyright in the information society – A Guide to National Implementation of the European Directive, edited by B. Lindner & T. Shapiro, Edward Elgar Publishing Ltd, 2011 (Chapter on Luxembourg, by K. Manhaeve & Th. Schiltz), p. 368 ; Institute for Information Law (IVIR), Study on the implementation and effect in Member States’ laws of Directive 2001/29/EC on the harmonization of certain aspects of copyright and related rights in the information society, Part II, Country reports, G. Westkamp, Final report, February 2007, p. 326.

1416 Copyright in the information society – A Guide to National Implementation of the European Directive, edited by B. Lindner & T. Shapiro, Edward Elgar Publishing Ltd, 2011 (Chapter on Malta, by B. Lindner & T. Shapiro), p. 384 et s. Institute for Information Law (IVIR), Study on the implementation and effect in Member States’ laws of Directive 2001/29/EC on the harmonization of certain aspects of copyright and related rights in the information society, Part II, Country reports, G. Westkamp, Final report, February 2007, p. 338.

weighing of the interests of rightholders against the social or economic interests of others or of society as a whole. After the adoption of the Directive, opinions continued to diverge as to whether an application by analogy was still possible. And when implementing the Directive, the Dutch legislator tried to give “*the implementation law a strong accent of a liberal legislative operation, striving at an open system of copyright with space for, in a certain emphasis on, freedom of information*”<sup>1417</sup>. **The quotation right, which already existed, was broadened** on the occasion of the implementation of the InfoSoc Directive. Even before the implementation of the Directive, the quotation right was applied in a rather permissive way<sup>1418</sup>; it did i.a. not have to be short or small. A whole work could be reproduced (e.g. photographs), even if this was debated in the legal doctrine. At least, an accepted limit to the right of quotation is that it may not essentially prejudice the interests in the exploitation of the work<sup>1419</sup>. A quotation is permissible in an advertisement, for criticism or in a scientific treatise, but also in a publication for a comparable purpose. The other conditions of the InfoSoc Directive have also been reflected in the text. Further, moral rights of the author must be respected<sup>1420</sup>. It was also stated that the fact that some exceptions were not taken over from the catalogue list could not lead to an interpretation “*a contrario*”<sup>1421</sup> (which may be hard to resist).

**Poland:** According to Article 29.1. of the Copyright Act, quotations from disseminated works or copying of minor works in their entirety **are allowed** in works constituting an independent whole, to the extent justified by explanation, critical analysis, instruction or requirements of a specific type of art form<sup>1422</sup>. The source must be indicated, whenever possible.

**Portugal:** Article 75.2 (g) **allows quotations** to support one’s own ideas or for the purposes of criticism, discussion or education, to the extent justified by the purpose in question (the latter condition being added to the pre-existing legislation on the right of quotation, when implementing the InfoSoc Directive)<sup>1423</sup>. There is no explicit requirement that the source, including the author’s name, be indicated<sup>1424</sup>.

**Romania:** Article 33.1 (b) of the Copyright Act **allows “the use of brief quotations** from a work for the purpose of an analysis, commentary or criticism, or for illustration, to the extent justified by the use thereof” if the work was already disclosed to the public and provided that such uses conform to proper practice, are not at variance with the normal exploitation of the work and are not prejudicial to the author or to the owners of the exploitation rights<sup>1425</sup>.

---

1417 Copyright in the information society – A Guide to National Implementation of the European Directive, edited by B. Lindner & T. Shapiro, Edward Elgar Publishing Ltd, 2011 (Chapter on the Netherlands by A. Quaedvlieg), p. 398. See also on the history of the implementation of the InfoSoc Directive and the debates which surrounded it, FIPR, Implementing the EU InfoSoc Directive, 2004, p. 101.

1418 Idem, p. 415.

1419 See the recent case law cited by A. Quaedvlieg, eod. loco, p. 416.

1420 Institute for Information Law (IVIR), Study on the implementation and effect in Member States’ laws of Directive 2001/29/EC on the harmonization of certain aspects of copyright and related rights in the information society, Part II, Country reports, G. Westkamp, Final report, February 2007, p. 356.

1421 FIPR, Implementing the EU InfoSoc Directive, p. 100

1422 Institute for Information Law (IVIR), Study on the implementation and effect in Member States’ laws of Directive 2001/29/EC on the harmonization of certain aspects of copyright and related rights in the information society, Part II, Country reports, G. Westkamp, Final report, February 2007, p. 385 (where the author of the report adds that the provision fulfils the requirements of the Directive).

1423 Copyright in the information society – A Guide to National Implementation of the European Directive, edited by B. Lindner & T. Shapiro, Edward Elgar Publishing Ltd, 2011 (Chapter on Portugal by P. Akester), p. 446.

1424 Institute for Information Law (IVIR), Study on the implementation and effect in Member States’ laws of Directive 2001/29/EC on the harmonization of certain aspects of copyright and related rights in the information society, Part II, Country reports, G. Westkamp, Final report, February 2007, p. 395.

1425 The translation is from WIPO. See also, Copyright in the information society – A Guide to National Implementation of the European Directive, edited by B. Lindner & T. Shapiro, Edward Elgar Publishing Ltd, 2011 (Chapter on Romania by M. Voican), p. 465.

**Slovak Republic:** Section 25 of the Copyright Act provides that **quotations of a short part of a disclosed work in another work is allowed** only for purposes of review or criticism of a disclosed work or for teaching, scientific, research or artistic purposes. The quotation must be in compliance with customary practice and limited to what is necessary. It shall mention the name of the author and the title of the work as well as its source<sup>1426</sup>.

**Slovenia:** According to Article 51 of the Copyright Act, **it shall be permissible to make quotations** of parts of a disclosed work and of single disclosed, photographs, works of fine arts, architecture, applied art, industrial design and cartography, provided it is necessary for the purpose of illustration, argumentation or referral. The source and authorship of the work must be indicated, if the latter is indicated on the work used<sup>1427</sup>.

**Spain:** According to Article 32 of the Copyright Act, fragments of written, sound or audiovisual works or isolated plastic, photographic, figurative or analogous works **may be included in another original work** for the purposes of teaching or research if the following conditions are met: the source work has been published; it is included for citation or for analysis, commentary or critical judgment; it is included with a citation of the source and the name of the author; it is only included to the extent justified by the purposes of teaching or research<sup>1428</sup>.

In principle, literary, audiovisual or musical works cannot be "quoted" in full (only photographs and, in general, works of visual art could be so). However, courts are ready to allow the quotation of full literary works as long as this is "justified by the purpose of the inclusion."<sup>1429</sup>

Usually, the language "by way of **quotation** or for analysis, comment or critical assessment," has been interpreted broadly by courts<sup>1430</sup>. As indicate, quotations may only be made "for teaching or research purposes" and "to the extent justified by the purpose of the inclusion." In Spanish law, the quotation limitation has always been restricted only to purposes of teaching and research. It should be noted that despite the fact that Act 23/2006 introduced a specific exception for teaching purposes, the quotation exception remains restricted to teaching and research purposes. As a result, courts feel compelled to grant a rather flexible and broad construction of these two concepts, as long as the specific use is made "to the extent justified by the purpose of the inclusion"<sup>1431</sup> and within the parameters of art. 40bis TRLPI (that is, it does not prejudice either the author or the normal exploitation of the quoted work)<sup>1432</sup>.

---

1426 Copyright in the information society – A Guide to National Implementation of the European Directive, edited by B. Lindner & T. Shapiro, Edward Elgar Publishing Ltd, 2011 (Chapter on the Slovak Republic by S. Olsovsky), p. 491.

1427 The translation is from WIPO. See also, Copyright in the information society – A Guide to National Implementation of the European Directive, edited by B. Lindner & T. Shapiro, Edward Elgar Publishing Ltd, 2011 (Chapter on Slovenia, by M. Trampuz), p. 499 et s.

1428 Copyright in the information society – A Guide to National Implementation of the European Directive, edited by B. Lindner & T. Shapiro, Edward Elgar Publishing Ltd, 2011 (Chapter on Spain by M. Garcia Leon), p. 520; FIPR, Implementing the EU InfoSoc Directive, 2004, p. 115 (about the draft legislation implementing the InfoSoc Directive). For some case-law, see AP Barcelona (sec.15) October 31, 2002 [Barcanova] Westlaw.ES JUR2004/54771; AP Madrid (sec.14) December 23, 2003 [Fundación Santamaría] Westlaw.ES JUR2004/90140.

1429 See AP Sevilla (sec. 6) October 30, 2003 [Apuntes] Westlaw.ES AC2003/1828: the making of teaching compilations (reproducing full literary works) is covered under art.32(1) TRLPI.

1430 See AP Barcelona (sec.15) October 31, 2002 [Barcanova] Westlaw.ES JUR2004/54771: allowing (as a quotation) the unauthorized and free reproduction of works of visual art to "illustrate" school books, the court interpreted 'by way of quotation' as independent from analyzing, commenting or criticizing the quoted work: a quotation may be allowed simply to "illustrate, complement, show or facilitate the explanation contained in the textbook," as long as it is done "to the extent justified by the purpose."

1431 See AP Sevilla (sec. 6) October 30, 2003 [Apuntes] Westlaw.ES AC2003/1828: the making of teaching compilations (also reproducing full literary works) is covered under art.32(1) TRLPI, because the scope of the reproduction is justified by the teaching purpose. The justification of the quotation may also be examined taking into account the "contextual importance of the quoted parts": see AP Valencia (sec.9) January 3, 2007 [Contrato de seguro] Westlaw.ES AC2007/1252; the "substantial and important" nature of the quoted parts: see AP La Coruña (sec.5) March 23, 1999 [Autonomía y Heteronomía Moral] Westlaw.ES AC1999/1570; or the



This limitation does not formally exclude commercial purposes, which means that they are perfectly allowed under it as long as they are kept within the scope of art.40bis TRLPI<sup>1433</sup>.

**Sweden:** our understanding (but this being said with some precaution as we could not verify it with all certainty) is that the exception is more or less identical as the one from the Directive.

**United Kingdom:** when implementing the InfoSoc Directive, the UK adopted a rather conservative approach by choosing to retain its existing exceptions and limitations and only amending them whenever required by the InfoSoc Directive. Under Article 30.1 of the Copyright legislation (whose title is : "*Criticism, review and news reporting*"), it is stated that "*fair dealing with a work for the purpose of criticism or review, of that or another work or of a performance of a work, does not infringe any copyright in the work provided that it is accompanied by a sufficient acknowledgement and provided that the work has been made available to the public*". The latter condition was added to the pre-existing legislation to comply with the InfoSoc Directive, even if it steered some debate due to the fact that this was seen by some as restricting freedom of expression<sup>1434</sup>.

### 3. General observations on the quotation exception

As general comments on the overall picture concerning the implementation of the quotation exception, one may mention the following:

- As indicated earlier, the initial text of the draft directive from the Commission already provided for an exception for quotation and the text thereof did not change much during the legislative process, which is an indication that the principle of such exception was not very controversial;
- This is probably why all Member States either already had or have introduced such exception when implementing the Copyright Directive. So, the exception exists in all Member States (be it added that it is somewhat uncertain in Bulgaria that the text applies to the Internet). It means that the exception did not have to be made compulsory for it to be adopted in all Member States (without prejudice however to the right of a Member State to, in the future, eliminate such exception from its list – this seems highly unlikely).

However, some countries enlarged the pre-existing exception while others added new conditions to it. And a closer look at the various legislations indicates that:

- Only in 2 Member States (Belgium and Portugal) has it been made clear that exceptions could not be waived by contract (within however the limits deriving from the InfoSoc Directive). In the Danish Copyright Act, it has not been made clear, and in the Danish legal literature, it is disputed whether exceptions can be waived by contract or not;

amount of quoted material, in relation to the resulting work: see AP Ciudad Real (sec.1) March 2, 2001 [Unión Eléctrica Fenosa] Westlaw.ES JUR2001/149833 (nine pages of copied material—within a 19-page brochure—giving no credit to the author of the quoted work, is not exempted as a quotation).

1432 See AP Barcelona (sec.15) October 31, 2002 [Barcanova] Westlaw.ES JUR2004/54771: confirming that the use of works of visual art to "illustrate" school books was exempted as a quotation because these were used for teaching. As expressly stated by the court, the only quotations that are not covered by art.32(1) TRLPI are those which are not done for teaching or research purposes, or which do not fulfill the other requirements (fragments or isolated works of art, extent justified by the purpose, etc), or which cause an unjustified prejudice to the author or damage the normal exploitation of the quoted works (ex art.40bis TRLPI).

1433 See AP Barcelona (sec.15) October 31, 2002 [Barcanova] Westlaw.ES JUR2004/54771: "the quotation [of works of visual art in school books] may indeed cause some prejudice, but it cannot be deemed unjustified and, because from its context, it does not prevent a normal exploitation of the works reproduced"; the court confirmed that the use was exempted as a quotation "regardless of the fact that the textbooks are being sold and the publisher has a clear for profit intent." See also AP Madrid (sec.14) December 23, 2003 [Fundación Santamaría] Westlaw.ES JUR2004/90140: commercial textbooks (used in official teaching programs) can benefit from the quotation exception.

1434 Copyright in the information society – A Guide to National Implementation of the European Directive, edited by B. Lindner & T. Shapiro, Edward Elgar Publishing Ltd, 2011 (Chapter on the United Kingdom by T. Aplin), p. 572.

- “Quotation” is often considered as meaning than only parts (or “small parts” of a work may be reproduced but this is not always the case and some countries (the Netherlands) are more liberal than others (France, Luxembourg), while in Ireland, it is debatable whether the size of the quotation matters or not ;
- It is sometimes recalled that the intellectual legacy of the pre-existing work must be respected and reflected in a recognizable way (Estonia, Belgium<sup>1435</sup>), but not all Member States require that condition;
- Some Member States (Belgium, Italy) prohibit quotations for commercial purposes; in some Member States, the quotation may not prejudice the commercial exploitation of the work or otherwise cause a prejudice to the author, in some other Member States, such condition is not mentioned or not existing.

#### 4. Case-law of the Court of Justice

One should remember that the Court of Justice, in its Painer decision<sup>1436</sup>, gave two (or maybe only one actually) additional explanations on the conditions of application of the quotation exception which will entail changes to some Member States’ legislation or case-law, i.e.:

The first question was : “ *Is Article 5(3)(d) of Directive 2001/29 ..., in the light of Article 5(5) of that directive, to be interpreted as meaning that its application is not precluded where a press report quoting a work or other protected matter is not a literary work protected by copyright?*” Even if it relates to a press report in this particular case, the question is relevant for all UGC materials quoting pre-existing works.

The Court of Justice answered to this first question as follows:

*“130 In that regard, it is appropriate to note at the outset that Article 5(3)(d) of Directive 2001/29 sets out a series of conditions for its application which do not include a requirement that a work or other protected subject-matter must be quoted as part of a literary work protected by copyright.(...)”*

*132 As regards the context surrounding Article 5(3)(d) of Directive 2001/29, it is important to note that, as stated in recital 31 in the preamble to that directive, a ‘fair balance’ must be safeguarded between, on the one hand, the rights and interests of authors, and, on the other, the rights of users of protected subject-matter.*

*133 It is also important to note that while the conditions set out in Article 5(3)(d) of Directive 2001/29 must, according to the Court’s case-law referred to in paragraph 109 of the present judgment, be interpreted strictly, since that provision is a derogation from the general rule established by that directive, the fact remains that the interpretation of those conditions must also enable the effectiveness of the exception thereby established to be safeguarded and its purpose to be observed (see, to that effect, Football Association Premier League and Others, paragraphs 162 and 163).*

*134 Article 5(3)(d) of Directive 2001/29 is intended to strike a fair balance between the right to freedom of expression of users of a work or other protected subject-matter and the reproduction right conferred on authors.*

---

1435 M.C. Janssens, in *La loi belge sur le droit d’auteur*, Commentaire par article, Hommage à Jan Corbet, Larcier, ed. F. Brison & H. Vanhees, 3rd ed., p. 139.

1436 Case C-145/10 (Third Chamber), 1 December 2011, (Eva-Maria Painer); V. Dahan & Ch. Bouffier, « Arrêt Painer du 1er décembre 2011 : la CJUE poursuit son oeuvre d’harmonisation du droit d’auteur », *Revue Lamy Droit de l’immatériel*, March 2012, n° 80, p. 14 et s.

135 *That fair balance is struck, in this case, **by favouring the exercise of the users' right to freedom of expression over the interest of the author** in being able to prevent the reproduction of extracts from his work which has already been lawfully made available to the public, whilst ensuring that the author has the right, in principle, to have his name indicated. (emphasis added)*

136 *From those two opposing points of view, the issue of whether the quotation is made as part of a work protected by copyright or, on the other hand, as part of a subject-matter not protected by copyright, is irrelevant.*

137 *In the light of all the foregoing considerations, the answer to question 2(a) is that Article 5(3)(d) of Directive 2001/29, read in the light of Article 5(5) of that directive, must be interpreted as not precluding its application where a press report quoting a work or other protected subject-matter is not a literary work protected by copyright.*

If applied to UGC, it clearly means that the UGC (quoting a pre-existing work) must not even qualify as “a work” protected by copyright for the quotation exception to be applicable. The copyright protected status of UGC (quoting a pre-existing work) does therefore not play as a condition to allow a quotation. Consequently, all UGC can benefit from the exception, provided the other conditions to the quotation right are met.

The second question relevant for our analysis read as follows:

*“138 By question 2(b), the referring court is asking, in essence, whether Article 5(3)(d) of Directive 2001/29, read in the light of Article 5(5) of that directive, must be interpreted as precluding its application where the name of the author or performer of the work or other protected subject-matter quoted is not indicated”.*

The answer was as follows:

*“139 The provisions of Article 5(3)(d) of Directive 2001/29 establish the obligation of principle that, for quotations, the source, including the author's name, unless that turns out to be impossible, be indicated, it being understood that the work or other protected subject-matter quoted has already been lawfully made available to the public.(...)*

*149 In the light of all the foregoing considerations, the answer to question 2(b) is that Article 5(3)(d) of Directive 2001/29, read in the light of Article 5(5) of that directive, must be interpreted as meaning that its application is subject to the obligation to indicate the source, including the name of the author or performer, of the work or other protected subject-matter quoted. However, if, in applying Article 5(3)(e)<sup>1437</sup> of Directive 2001/29, that name was not indicated, that obligation must be regarded as having been fulfilled if the source alone is indicated.”*

This second answer does not add much to the text of the directive, which it basically confirms, i.e. the name of the author or performer and the source must be mentioned unless this proves impossible.

In practice, one must admit that for many UGC works, this condition is not respected and, in many instances, the source and the name of the author or performer is not mentioned, even when this would have been possible. This is probably due to a lack of information by users ignoring this legal condition,

---

<sup>1437</sup> Article 5.3.(e) reads as follows: “(e) use for the purposes of public security or to ensure the proper performance or reporting of administrative, parliamentary or judicial proceedings”.

but also to the fact that rightholders do not yet sufficiently rely on the “rights management information systems”, as encouraged by article 7 of the InfoSoc Directive (even if one must remember that recourse to such rights management information is obviously not a pre-condition to copyright protection).

More generally, if a certain percentage of UGC works do contain quotations of pre-existing works, it does not appear to us that this is the case for most UGC works. Harmonizing the conditions more precisely would facilitate the authors of some UGC works but will not, as such, provide “the solution” to UGC in general if there was to be a need to facilitate its dissemination on the Web.

Despite this, some have tried to come up with a text which would harmonize the situation in Europe, by adopting a Memorandum of Understanding concerning the Interpretation of the Right of Quotation, in May 2012. Such MoUs, if adopted by many stakeholders, may help in giving greater clarity to users, even though our impression, in this case, is that the draft MoU goes too far in allowing quotations; a detailed analysis is out of the scope of this report<sup>1438</sup>.

We will not yet suggest here what our own recommendations would be regarding quotations, as the Commission asked us to divide the “as is” part of our work from the “to be” part (which will come after this first part).

## B. Caricature, parody and pastiche

### 1. General presentation

The Copyright Directive, under article 5.3.(k) allows Member States to provide for an exception for caricature as follows:

*“(k) use for the purpose of caricature, parody or pastiche”.*

The Berne Convention and the other international treaties on copyright do not provide for an exception for such purpose, so that one may and should fall back on the general three-steps-test provision to justify the existence of such exception in many States and verify its limits<sup>1439</sup>. In some countries, notably in the U.S.<sup>1440</sup>, it is through case-law that such exception has been admitted.

It will in this regard be interesting to see the answers which the EUCJ will give to the questions which have just recently been referred to her regarding parody by the Brussels Court of appeal<sup>1441</sup>.

1438 The text of the MoU is available here : <http://a2knetwork.org/quotation>. It was mainly prepared by M. Senftleben (Vrije Universiteit Amsterdam). It contains interesting proposals but at the same times goes too far on some other issues.

1439 M. Ficsor, “Comments on the UGC provisions in the Canadian Bill C-32: potential dangers for unintended consequences in the light of the international norms on copyright and related rights” (23 October 2010), available at [http://www.copyrightseesaw.net/archive/?sw\\_10\\_item=31](http://www.copyrightseesaw.net/archive/?sw_10_item=31), p. 10.

1440 See the US Supreme Court Decision in *Campbell v. Acuff-Rose*, 510 US 596 (1994) and the later decisions on such exception.

1441 The Court of appeal of Brussels, in its arrest dd 8 April, 2013 (*Deckmyn v Vandersteen en Vrijheidsfonds VZW v. Vandersteen*) raises the following questions to the EUCJ (Request for a preliminary ruling from the Hof van beroep te Brussel (Belgium) lodged on 17 April 2013 — *Johan Deckmyn, Vrijheidsfonds VZW v Helena Vandersteen and Others*, (Case C-201/13) (2013/C 189/11):

1. Is the concept of ‘parody’ an independent concept in European Union law?
2. If so, must a parody satisfy the following conditions or conform to the following characteristics:
  - the display of an original character of its own (originality);
  - and such that the parody cannot reasonably be ascribed to the author of the original work;
  - be designed to provoke humour or to mock, regardless of whether any criticism thereby expressed applies to the original work or to something or someone else;

## 2. Analysis in the Member States

We shall hereafter describe how this exception has been implemented in the Member States.

**Austria:** the parody exception **was not introduced in the Copyright Act** when implementing the Directive<sup>1442</sup>. However, some commentators consider that “the freedom to make caricatures is safeguarded under general principles of copyright law and will seldom amount to a reproduction or adaptation”<sup>1443</sup>; in our view, it may be difficult, for many caricatures or parodies, to sustain that they do not amount to a reproduction (considering the wide definition of such term by the Copyright Directive) or to an adaptation, so that this conclusion may, in our view, be over-optimistic on the existence of a right of caricature.

**Belgium:** The caricature exception **already existed since the first Belgian Copyright Act of 1886 and was maintained in the Copyright Act**, provided that it must take into account honest practices. There is no difference between caricature, parody or pastiche and no limitation regarding the importance of the taking from the pre-existing work or regarding the type of work which may be parodied. Case-law has however often interpreted the exception narrowly and requires the following cumulative conditions: the parody must itself be original, have a purpose of criticism, be somewhat humorous and may not cause confusion with the pre-existing work. It is sometimes further required that the parody not have a commercial purpose and not have as its main or sole purpose to cause prejudice to the pre-existing work. The parody may not overrule the moral right of integrity (the honour or reputation of the author may not be damaged) and article 10 of the EDHR may not be invoked to allow infringements to the moral right of integrity. The weighing of these different principles is described as a difficult exercise<sup>1444</sup>.

**Bulgaria:** the parody exception **was not introduced** when implementing the Copyright Directive<sup>1445</sup>, for fear of abuses of such exception. There seems to be no case-law on caricature in Bulgaria.

**Cyprus:** the parody exception **has not been introduced**<sup>1446</sup>. However, such limitations are recognized under the non-statutory limitations of freedom of communication or press as they are safeguarded by the Constitution<sup>1447</sup>.

**Czech Republic:** the parody exception **does not seem to have been introduced**<sup>1448</sup>

**Denmark:** the parody exception **was not introduced** when implementing the Copyright Directive<sup>1449</sup>. However, caricatures will often be deemed new and independent works of art under Section 4 (2) of the

— mention the source of the parodied work?

3. Must a work satisfy any other conditions or conform to other characteristics in order to be capable of being labelled as a parody?

1442 Copyright in the information society – A Guide to National Implementation of the European Directive, edited by B. Lindner & T. Shapiro, Edward Elgar Publishing Ltd, 2011 (Chapter on Austria by F. Philapitsch), p. 73.

1443 Institute for Information Law (IVIR), Study on the implementation and effect in Member States’ laws of Directive 2001/29/EC on the harmonization of certain aspects of copyright and related rights in the information society, Part II, Country reports, G. Westkamp, Final report, February 2007, p. 113.

1444 M.C. Janssens, in La loi belge sur le droit d’auteur, Commentaire par article, Hommage à Jan Corbet, Larquier, ed. F. Brison & H. Vanhees, 3rd ed., p. 168.

1445 Copyright in the information society – A Guide to National Implementation of the European Directive, edited by B. Lindner & T. Shapiro, Edward Elgar Publishing Ltd, 2011 (Chapter on Bulgaria by V. Sokolov), p. 111.

1446 Copyright in the information society – A Guide to National Implementation of the European Directive, edited by B. Lindner & T. Shapiro, Edward Elgar Publishing Ltd, 2011 (Chapter on Cyprus by A. Demetriades), p. 128.

1447 Institute for Information Law (IVIR), Study on the implementation and effect in Member States’ laws of Directive 2001/29/EC on the harmonization of certain aspects of copyright and related rights in the information society, Part II, Country reports, G. Westkamp, Final report, February 2007, p. 143.

1448 Copyright in the information society – A Guide to National Implementation of the European Directive, edited by B. Lindner & T. Shapiro, Edward Elgar Publishing Ltd, 2011 (Chapter on the Czech Republic by L. Pressburgerova & J. Tajbr), p. 156.

Copyright Act and thus fall outside of the copyright protection of the pre-existing work<sup>1450</sup>. It remains to be seen, in our view, if this is consistent with the existence of an autonomous adaptation right as provided for by the Berne Convention.

**Estonia:** a parody may be made of a lawfully published work, to the extent justified by such purpose, which must be scientific, educational or informational<sup>1451</sup>.

**Finland:** the caricature exception was not introduced explicitly when implementing the Copyright Directive (contrary to most exceptions of the catalogue), but it is admitted that parodies may be made, on the basis that ideas may not be protected, and with this limit that the parody may not be an adaptation of the pre-existing work (in which case it requires a licence)<sup>1452</sup>. Some commentators add that parody is recognised as a general principle of Finnish copyright law<sup>1453</sup>; this may, however, seem insufficient as a system to ensure transparency and clarity for users.

**France:** the caricature exception already existed before the Copyright Directive and the text was not changed upon implementation of said Directive; caricatures must however comply “with the laws of the genre” (which gave rise to numerous court decisions)<sup>1454</sup>.

**Germany:** the caricature exception existed prior to the Copyright Directive<sup>1455</sup>. It is sometimes considered that this is not even a limitation to copyright but presupposes that caricatures do not constitute reproductions or adaptations<sup>1456</sup> (an opinion about which one may have his doubts for many cases of caricature).

**Greece:** the parody exception does not exist as such under Greek law and was not introduced when implementing the Copyright Directive<sup>1457</sup>. In theory, some commentators consider that it would fall under the freedom of communication or of the press, but there does not seem to exist any case-law confirming or infirming such view<sup>1458</sup>.

**Hungary:** even though no explicit provision exists under the Copyright Act, legal literature and practice accept the exception provided that the use must correspond to the conditions of the quotation exception

---

1449 Copyright in the information society – A Guide to National Implementation of the European Directive, edited by B. Lindner & T. Shapiro, Edward Elgar Publishing Ltd, 2011 (Chapter on Denmark by P. Schonning), p. 168.

1450 Institute for Information Law (IVIR), Study on the implementation and effect in Member States' laws of Directive 2001/29/EC on the harmonization of certain aspects of copyright and related rights in the information society, Part II, Country reports, G. Westkamp, Final report, February 2007, p. 163.

1451 Copyright in the information society – A Guide to National Implementation of the European Directive, edited by B. Lindner & T. Shapiro, Edward Elgar Publishing Ltd, 2011 (Chapter on Estonia by V. Naslund), p. 180.

1452 Copyright in the information society – A Guide to National Implementation of the European Directive, edited by B. Lindner & T. Shapiro, Edward Elgar Publishing Ltd, 2011 (Chapter on Finland by K. Harenko), p. 191.

1453 Institute for Information Law (IVIR), Study on the implementation and effect in Member States' laws of Directive 2001/29/EC on the harmonization of certain aspects of copyright and related rights in the information society, Part II, Country reports, G. Westkamp, Final report, February 2007, p. 197.

1454 Copyright in the information society – A Guide to National Implementation of the European Directive, edited by B. Lindner & T. Shapiro, Edward Elgar Publishing Ltd, 2011 (Chapter on France by P. Kamina), p. 214.

1455 Copyright in the information society – A Guide to National Implementation of the European Directive, edited by B. Lindner & T. Shapiro, Edward Elgar Publishing Ltd, 2011 (Chapter on Germany by M. Schaefer), 223.

1456 Institute for Information Law (IVIR), Study on the implementation and effect in Member States' laws of Directive 2001/29/EC on the harmonization of certain aspects of copyright and related rights in the information society, Part II, Country reports, G. Westkamp, Final report, February 2007, p. 230.

1457 Copyright in the information society – A Guide to National Implementation of the European Directive, edited by B. Lindner & T. Shapiro, Edward Elgar Publishing Ltd, 2011 (Chapter on Greece by E. Vagena), p. 243.

1458 Institute for Information Law (IVIR), Study on the implementation and effect in Member States' laws of Directive 2001/29/EC on the harmonization of certain aspects of copyright and related rights in the information society, Part II, Country reports, G. Westkamp, Final report, February 2007, p. 250.

or (yet this view is not shared by all, all the more so if one considers that exceptions must be interpreted narrowly)<sup>1459</sup> consist in a humoristic-critical imitation of a given author's style<sup>1460</sup>. The expert opinion 16/2008 of the Hungarian Copyright Expert Board had to discuss whether a secondary television advertisement is a use (adaptation) of a pre-existing ad. The defendant argued that the latter ad was a parody. The Board discussed the question of parody on a theoretical level and after that – based upon the facts of the case – said that even though the Hungarian Copyright Act does not have any expressed provision on parody, works that are built upon pre-existing materials, but where the original work disappears (and becomes invisible, undistinguishable) in the latter one, one cannot talk about a permissible use.

**Ireland:** apart from the fair dealing exception which can be invoked in regard of quotations for criticism or review, or for the reporting of current events, there is **no explicit provision on caricature in the Copyright Act**; this relying on the fair dealing exception requires however that the extent of the borrowing from the pre-existing work may not be greater than what is strictly necessary for the purpose<sup>1461</sup>.

**Italy:** the caricature exception **was not taken over when implementing the Copyright Directive**; however, there is consistent case-law stating that caricature and parody are allowed on the basis of Article 21 of the Constitution that enshrines the fundamental right of freedom of expression<sup>1462</sup>. It is generally considered that caricatures have the purpose of twisting or overturning the original meaning of the work, thus arriving at expressing essentially different concepts<sup>1463</sup>. When this happens, “the link with the original work and the parody adaptation is definitively cut artistically, logically and legally”<sup>1464</sup>; it does not seem to us that this will always be the case. Parodies which would fulfill the conditions of quotations and thus not conflict with a normal exploitation of the work would apparently be acceptable<sup>1465</sup>. As recalled in the text, considering the **non-existence of an express parody exception** under Italian law, courts have relied on the principle of **freedom of expression** (Art. 21 Constitution) and on the provision of Art. 4 of the Italian Copyright Act, which allows courts to recognize the *autonomous character* of parodies (as derivative works) and to shield them from claims coming from the author of the original work. For such creations the follow-on author does not need to obtain the authorization of the author of the original work (i.e., the work that the follow-on author makes fun of). The Italian case law is so well developed in this respect that the legislator did not feel the necessity to introduce the parody exception into the Copyright Act at the time of the transposition of the 2001 Directive into Italian law.

---

1459 Institute for Information Law (IVIR), Study on the implementation and effect in Member States' laws of Directive 2001/29/EC on the harmonization of certain aspects of copyright and related rights in the information society, Part II, Country reports, G. Westkamp, Final report, February 2007, p. 262, where no reference is made to such possibility.

1460 Copyright in the information society – A Guide to National Implementation of the European Directive, edited by B. Lindner & T. Shapiro, Edward Elgar Publishing Ltd, 2011 (Chapter on Hungary by M. Ficsor), p. 265.

1461 Copyright in the information society – A Guide to National Implementation of the European Directive, edited by B. Lindner & T. Shapiro, Edward Elgar Publishing Ltd, 2011 (Chapter on Ireland by L. Scales), p. 288; Institute for Information Law (IVIR), Study on the implementation and effect in Member States' laws of Directive 2001/29/EC on the harmonization of certain aspects of copyright and related rights in the information society, Part II, Country reports, G. Westkamp, Final report, February 2007, p. 278.

1462 Copyright in the information society – A Guide to National Implementation of the European Directive, edited by B. Lindner & T. Shapiro, Edward Elgar Publishing Ltd, 2011 (Chapter on Italy by S. Ercolani), p. 316.

1463 See for instance Court of Naples, 15.02.2000 – or Court of Bologna, 21.10.1991, which found lawful the unauthorized use of drawings protected by copyright in the creation of satirical comics. In this context the parodist was found to use the distinctive elements of the original creations in order to twist or overturn the original meaning, modifying also the shape of graphical elements through new and original additions that radically altered the semantics of the original work.

1464 Idem.

1465 Institute for Information Law (IVIR), Study on the implementation and effect in Member States' laws of Directive 2001/29/EC on the harmonization of certain aspects of copyright and related rights in the information society, Part II, Country reports, G. Westkamp, Final report, February 2007, p. 291. In the same sense, FIPR, Implementing the EU InfoSoc Directive, 2004, p. 88.

**Latvia:** the caricature exception **does exist under copyright**<sup>1466</sup>.

**Lithuania:** the caricature exception **is similar to the provision of the Copyright Directive**<sup>1467</sup>.

**Luxembourg:** the Copyright Act **allows caricatures** aimed at mocking the parodied work provided that they are in accordance with fair practice and that they only use elements strictly necessary for the parody and do not disparage the work. It is worth noting that the initial intention of the legislator to allow any parody or caricature without any further condition was not retained<sup>1468</sup>. Commentators insist that the purpose must be to “make fun” of the parodied work<sup>1469</sup>.

**Malta:** the pre-existing exception for parody was kept when implementing the Copyright Directive<sup>1470</sup>.

**The Netherlands:** as explained above, the discussions on exceptions to be introduced were rather strong in the Netherlands. The implementation of the Copyright Directive was the occasion to introduce the caricature exception under Dutch law, an exception which had been the subject of many debates for years. Debates do continue as to whether the exceptions have necessarily to be interpreted narrowly and how they must be combined with the three-steps-test<sup>1471</sup>. Before this explicit exception, it had always been accepted that parodies were permissible, in particular since a decision by the Supreme Court in 1984; courts then referred to the Directive even before it was adopted (because the previous case-law was somewhat restrictive). The initial bill did not add any condition to the text of the Copyright Directive; however, **the final text introduced the requirement that the caricature be made in accordance with what is reasonably permitted according to the rules of social intercourse** (or the normal rules of social custom – depending on the translation). Commentators debated about the meaning of such additional proviso, some sustaining that it was a redundant reformulation of the three-step test; others argued otherwise. The District Court of Amsterdam dealt with the parody exception in the light of the freedom of expression of Article 10 ECHR, following some commentary on this<sup>1472</sup>. Discussions amongst commentators as to the extent and conditions of the parody exception have, not really surprisingly, been very lively in Dutch doctrine.

---

1466 Copyright in the information society – A Guide to National Implementation of the European Directive, edited by B. Lindner & T. Shapiro, Edward Elgar Publishing Ltd, 2011 (Chapter on Latvia by J. Bordans & I. Veiksa), p. 330.

1467 Copyright in the information society – A Guide to National Implementation of the European Directive, edited by B. Lindner & T. Shapiro, Edward Elgar Publishing Ltd, 2011 (Chapter on Lithuania by G. Ramanauskas), p. 352; Institute for Information Law (IVIR), Study on the implementation and effect in Member States' laws of Directive 2001/29/EC on the harmonization of certain aspects of copyright and related rights in the information society, Part II, Country reports, G. Westkamp, Final report, February 2007, p. 318.

1468 Copyright in the information society – A Guide to National Implementation of the European Directive, edited by B. Lindner & T. Shapiro, Edward Elgar Publishing Ltd, 2011 (Chapter on Luxembourg by K. Manhaeve & Th. Schiltz), p. 370.

1469 Institute for Information Law (IVIR), Study on the implementation and effect in Member States' laws of Directive 2001/29/EC on the harmonization of certain aspects of copyright and related rights in the information society, Part II, Country reports, G. Westkamp, Final report, February 2007, p. 327.

1470 Institute for Information Law (IVIR), Study on the implementation and effect in Member States' laws of Directive 2001/29/EC on the harmonization of certain aspects of copyright and related rights in the information society, Part II, Country reports, G. Westkamp, Final report, February 2007, p. 339.

1471 Copyright in the information society – A Guide to National Implementation of the European Directive, edited by B. Lindner & T. Shapiro, Edward Elgar Publishing Ltd, 2011 (Chapter on The Netherlands by A. Quaedvlieg), p. 395 and p. 418.

1472 See e.g. M. de Cock Buning, “De parodie exceptie nader beschouwd”, in W. Grosheide, 1996, quoted in Copyright in the information society – A Guide to National Implementation of the European Directive, edited by B. Lindner & T. Shapiro, Edward Elgar Publishing Ltd, 2011 (Chapter on The Netherlands by A. Quaedvlieg), p. 395 and p. 418. The Netherlands by A. Quaedvlieg), p. 419.



**Poland:** although it was stated that freedom of speech was to be one of the guiding principles of the implementation of the Copyright Directive<sup>1473</sup>, **we fail to see that the caricature exception has in fact been introduced.**

**Portugal:** the caricature exception **was not implemented in the Copyright Act**, “to avoid confusion with other exceptions”<sup>1474</sup>. Some commentators consider that it is allowed as a free use in general, being a use merely inspired by an existing work<sup>1475</sup>.

**Romania:** although the comment we read does not list article 5.3.(k) of the Copyright Directive (allowing the caricature exception) amongst the exceptions which were not taken over by the Romanian implementation legislation, **we fail to see the article which allows it** and the commentator does not mention it<sup>1476</sup>. It apparently fits within the quotation exception but must be justified by a specific type of an art form (which is to us difficult to interpret)<sup>1477</sup>.

**Slovak Republic :** the Copyright Act **does not contain a caricature exception**<sup>1478</sup>.

**Slovenia**<sup>1479</sup>: exceptions are mandatory and may not be overridden by contracts; on the other hand, free access to information does not allow courts to create new exceptions outside those which are explicitly provided for in the Copyright Act. Hardly any case-law exists on exceptions. We have yet to find the provision on caricature if it indeed exists.

**Spain:** a **pre-existing exception was part of the Copyright Act and was not modified** when implementing the Copyright Directive. It is considered that parodies are neither reproductions nor derivative works, on the basis of article 39 of the Copyright Act (an opinion about which one may have some doubts, in our view). A parodied author may however object to the parody if it causes confusion with the pre-existing work<sup>1480</sup>.

Art. 39 TRLPI declares that the **parody** of a previously disclosed work will not be considered as an unauthorized adaptation as long as there is no risk of confusion with the original work and no damage is caused to the original work or to its author. This limitation is directly justified by the fundamental right to

1473 Copyright in the information society – A Guide to National Implementation of the European Directive, edited by B. Lindner & T. Shapiro, Edward Elgar Publishing Ltd, 2011 (Chapter on Poland by W. Dziomdziora), p. 428.

1474 Copyright in the information society – A Guide to National Implementation of the European Directive, edited by B. Lindner & T. Shapiro, Edward Elgar Publishing Ltd, 2011 (Chapter on Portugal by P. Akester), p. 447, referring to the Nota Justificativa, e) 15 (h) of the Gabinete do Direito de Autor.

1475 Institute for Information Law (IVIR), Study on the implementation and effect in Member States' laws of Directive 2001/29/EC on the harmonization of certain aspects of copyright and related rights in the information society, Part II, Country reports, G. Westkamp, Final report, February 2007, p. 396 (referring to article 2 (1) n of the Copyright Act.

1476 Copyright in the information society – A Guide to National Implementation of the European Directive, edited by B. Lindner & T. Shapiro, Edward Elgar Publishing Ltd, 2011 (Chapter on Romania by M. Voican), p. 467.

1477 Institute for Information Law (IVIR), Study on the implementation and effect in Member States' laws of Directive 2001/29/EC on the harmonization of certain aspects of copyright and related rights in the information society, Part II, Country reports, G. Westkamp, Final report, February 2007, p. 386.

1478 Copyright in the information society – A Guide to National Implementation of the European Directive, edited by B. Lindner & T. Shapiro, Edward Elgar Publishing Ltd, 2011 (Chapter on the Slovak Republic by S. Olsovsky), p. 493.

1479 Copyright in the information society – A Guide to National Implementation of the European Directive, edited by B. Lindner & T. Shapiro, Edward Elgar Publishing Ltd, 2011 (Chapter on Slovenia by M. Trampuz).

1480 Institute for Information Law (IVIR), Study on the implementation and effect in Member States' laws of Directive 2001/29/EC on the harmonization of certain aspects of copyright and related rights in the information society, Part II, Country reports, G. Westkamp, Final report, February 2007, p. 424.

freedom of speech in art. 20 of the Spanish Constitution. However, in practice, it seems that it tends to cover rather spurious uses<sup>1481</sup>.

**Sweden:** there is **no parody exception in the law** but it is accepted that general principles of law, confirmed on this by case-law, lead to the conclusion that parodies are not infringing the rights of the authors. In a case in 2005 the Supreme Court considered a parody to be an independent work and therefore not infringing upon the pre-existing work<sup>1482</sup>.

**United Kingdom:** as is well known, **the parody exception does not exist as such under UK law**<sup>1483</sup>. The Gowers Review suggested introducing it; so did the Hargreaves review<sup>1484</sup>, but this has not been done so far. Following the Gowers Review, the UK Intellectual Property Office suggested its introduction but then changed its mind. The fair dealing exception however is probably already covering acts of parody<sup>1485</sup>, even if some commentators consider that “UK courts are traditionally reluctant to accept parodies as non-infringing”<sup>1486</sup>.

### 3. General observations on parodies, caricatures and pastiches

It appears in a number of countries that the parody exception was not implemented explicitly yet is often (but not in all countries) considered as covered by the freedom of expression or by general principles of law. The Copyright Directive does not state that, when Member States wish to introduce or retain a pre-existing exception, such should be made explicitly in the copyright legislation, yet one shall easily admit that a combination of explicit exceptions, often to be considered as having to be implemented narrowly, co-existing with implicit exceptions only to be found in the case-law or in the legal doctrine or in constitutional principles renders the task of the lawyers, legal advisers, let alone small enterprises or private individuals, more difficult and that this result does lack the transparency which one would be entitled to expect.

The chilling effect thereof is hard to assess because one would need, by definition, to gather information about intents or projects which did not materialize due to e.g. fears from users or caricaturists, but it seems logical to consider that the unharmonized situation renders projects more risky to assess *a priori* and may stifle users who would otherwise engage in UGC pieces of work.

---

1481 See the ruling by the AP Madrid (sec.13) February 2, 2000 [La Parodia Nacional] Westlaw.ES AC2000/848: the use of musical works with different lyrics created by participants in an entertainment TV program was deemed exempted as a parody because “it was meant for fun,” not as a commercial exploitation of the work; this ruling was heavily criticized by scholars. Instead, see AP Barcelona (sec.15) October 10, 2003 [El jueves] Westlaw.ES AC2003/1895 and AP Barcelona (sec.15) April 24, 2002 [MGM logo] Westlaw.ES JUR2004/14049, which denied that the so called “weapon parody” (when the work is used to make a parody of something or someone unrelated to it) is exempted by this limitation. See also M. Sol Muntañola, *El régimen jurídico de la parodia*, Marcial Pons, Madrid (2005).

1482 Institute for Information Law (IVIR), Study on the implementation and effect in Member States' laws of Directive 2001/29/EC on the harmonization of certain aspects of copyright and related rights in the information society, Part II, Country reports, G. Westkamp, Final report, February 2007, p. 434.

1483 Copyright in the information society – A Guide to National Implementation of the European Directive, edited by B. Lindner & T. Shapiro, Edward Elgar Publishing Ltd, 2011 (Chapter on the United Kingdom by T. Aplin), p. 573 and 574.

1484 I. Hargreaves, *Digital Opportunity, A review of intellectual property and growth*, 2011, p. 4 (i.a.). The author mentions the example of homemade parody “Newport State of Mind” (based upon Empire State of Mind, a hit song by the American rapper Jay-Z). The parody, achieved great success when posted on YouTube in 2010, but resulted in action by the right owners to exercise their rights under UK copyright law to have it removed from the internet.

1485 For an analysis of the parody exception under UK legislation, see the references quoted by T. Aplin, in *Copyright in the information society*, op. cit., p. 574.

1486 Institute for Information Law (IVIR), Study on the implementation and effect in Member States' laws of Directive 2001/29/EC on the harmonization of certain aspects of copyright and related rights in the information society, Part II, Country reports, G. Westkamp, Final report, February 2007, p. 446. See also IFPR, *Implementing the EU InfoSoc Directive*, 2004, p. 122.

The BEUC (European Consumer Organisation), about the parody exception <sup>1487</sup>:

- Observes that it has been implemented differently across the Member States (which we indeed illustrated above);
- Considers that “there is no evidence that a parody may result in lost sales of the original due to confusion between the original work and a parody”<sup>1488</sup>;
- Narrates the story of a caricature about Volkswagen uploaded on YouTube by Greenpeace, removed after a notice-and-take-down request by Volkswagen and then put back by YouTube which apparently considered that the issue had to be considered under US law in which this specific case would be permitted under the fair use doctrine<sup>1489</sup>; the video is still visible on YouTube at the moment. This example cannot really be considered as decisive for UGC and for the purposes of our analysis: it does not concern UGC (i.e. works made by individuals) and the caricature was finally admitted and reloaded on YouTube, so that the exception played its role. Arguably, it might even be considered as a counter-example.

In the second part of our part, we will discuss whether some solutions, if needed, for the promotion of UGC could be found around the parody exception.

## C. Incidental inclusion

### 1. General presentation

The Copyright Directive allows Member States to introduce an exception under article 5.3. (i) for the “*incidental inclusion of a work or other subject-matter in other material*”. This exception should not be confused with the exception of article 5.1. for “temporary acts of reproduction referred to in Article 2, which are transient or incidental”.

The recitals of the Directive do not give further explanation on the scope of such exception.

As with parodies and caricatures, the Berne Convention and the other international treaties on copyright do not provide for an exception for such purpose, so that one may and should fall back on the general three-steps-test provision to justify the existence of such exception and verify its limits.

There is, to our knowledge, neither case-law from the Court of Justice on this exception nor any prejudicial question presently pending<sup>1490</sup>.

The incidental inclusion exception, as mentioned by the Terms of Reference of our Study, may provide relief to certain cases of UGC, such as the examples often referred to of private video of weddings or other private or family events where some music may be heard in the background and where the fact that the video is made available on a publicly available platform makes it subject to possible claims for infringement under copyright or neighbouring rights. “Incidental” does not equal “in the background” but rather refers to “accidental” or “unintentional” takings and thus to situations in which the purpose of the user was not to capture the sounds or the images at stake but where such capture happened at the occasion of the recording of another element which was the real subject matter of the recording/creation by the user.

As noted by a recent US report<sup>1491</sup>, “*there are likely many incidental uses occurring in today’s technology –and media- saturated society, and in many instances they will not attract the attention of*

1487 BEUC, « EU InfoSoc Directive – a glance at exceptions & limitations – the need for revision », available on their website, p. 6.

1488 One may observe however that, from a legal point of view, this criterion is not really relevant. It is relevant only from a policy point of view.

1489 Idem.

1490 There is however US case-law on this issue.

the copyright holders or will not be challenged. However, there is enough documentation of chilling effects to indicate a need for the additional certainty that adding incidental uses to the preamble could provide". While not giving examples of such documentation on chilling effects in the report<sup>1492</sup> (yet referring to the existence of "a somewhat limited set of case law only")<sup>1493</sup>, the author suggests to add "incidental use" to the preamble of Section 107 of Title 17 of the United States Code (which is the provision dealing with fair use). The preamble actually only lists (in a *non-exhaustive* manner) criticism, comment, news reporting, teaching, scholarship and research) as grounds to justify a fair use exception under US law (provided that the other conditions of Section 107 are met); the author of the report argues that adding "incidental use" to this non-exhaustive list would avoid some aggressive actions taken by rightholders against users who incidentally included copyright protection works in a video footage or in another personal work. Such incidental and often unintentional inclusions should, he said, be considered as *de minimis* ("too trifling a use to even be considered an infringement")<sup>1494</sup>.

Interestingly, the report adds that if rightholders will not often initiate lawsuits against such uses, they may have recourse to the more simple remedy of a notice-and-take-down sent to the intermediary platform<sup>1495</sup>, or that automatic filtering systems which do not distinguish fair uses from infringements will automatically remove the video footage from the platform while it was actually not infringing<sup>1496</sup>.

Finally, one should not forget that even the most well-known platforms have no duty to accept uploads from users and that there is no such thing as a "right to upload" which a user could invoke vis-à-vis an individual platform to oblige the platform to accept its work (whether original, mere copy or UGC as we understand it in this Study).

## 2. Analysis in the Member States

When examining how this exception was implemented in the Member States, the situation may be described as follows:

**Austria:** the exception **was not included** when implementing the Copyright Directive<sup>1497</sup>.

1491 J.M. Urban, Copyright Reform Act, prepared on behalf of Public Knowledge, Report 1, "Updating Fair Use for Innovators and Creators in the Digital Age: Two Targeted Reforms, BerkeleyLaw, University of California, Samuelson Law, Technology & Public Policy Clinic, February 13, 2010, p. 12.

1492 And indeed, we could not find much of such evidence of a real "chilling effect" either.

1493 *Idem*, p. 13.

1494 *Idem*, p. 13. According to (our discussion with) Prof. Ginsburg, adding incidental use to Section 107 of the preamble accomplishes nothing because the list is merely illustrative, has never played a determinative role in the analysis and because there is already a longstanding caselaw on incidental use as *de minimis* or fair use.

1495 The *Lenz v. Universal Music Corp* case, discussed further in this report is often cited as an example of the abuse of notice-and-take-down procedures by rightholders in the US; whether it is a good example of such situation of incidental inclusion being sued by rightholders is not unanimously agreed by all commentators.

1496 The author of the report gives the following examples of a chilling effect situation:

- see posting of Fred von Lohmann to Deeplinks Blog, YouTube's January Fair Use Massacre, <http://www.eff.org/deeplinks/2009/01/youtubes-january-fair-use-massacre> (Feb. 3, 2009) (describing how, following a dispute between YouTube and Warner Music, YouTube's Content ID filtering system removed many user videos that used Warner's music without distinguishing fair from infringing uses);

- documentary filmmakers of American University's Center for Social Media apparently show that documentarians have been increasingly afraid of filming due to increased demands for permission fees and a lack of certainty around fair use defenses; see PATRICIA AUFDERHEIDE & PETER JASZI, UNTOLD STORIES: CREATIVE CONSEQUENCES OF THE RIGHTS CLEARANCE CULTURE FOR DOCUMENTARY FILMMAKERS 26 (2004), available at

[http://www.centerforsocialmedia.org/files/pdf/UNTOLDSTORIES\\_Report.pdf](http://www.centerforsocialmedia.org/files/pdf/UNTOLDSTORIES_Report.pdf) . A filmmaker commented (in a somewhat caricatured manner): "It's like saying I can't film the clouds" (report cited, p. 14).

1497 Copyright in the information society – A Guide to National Implementation of the European Directive, edited by B. Lindner & T. Shapiro, Edward Elgar Publishing Ltd, 2011 (Chapter on Austria, by F. Philipitsch), p. 73; Institute for Information Law (IVIR), Study on the implementation and effect in Member States' laws of Directive 2001/29/EC on the harmonization of certain aspects of copyright and related rights in the information society, Part II, Country reports, G. Westkamp, Final report, February 2007, p. 92.

**Belgium:** an exception already existed for the reproduction and communication to the public of **works exposed in public places** when the goal of the reproduction or communication is not the work itself – which is a mix of the incidental inclusion exception and of the exception allowed by article 5.3 (h) of the Copyright Directive. It mainly covers paintings or buildings but arguably not music for instance, since music is not “exposed” in public places. It is thus of limited uses for UGC.

**Bulgaria:** the exception **was not introduced in the law** because it was feared that such formulation would provide grounds for a wide interpretation and lead to abuses<sup>1498</sup>.

**Cyprus:** the exception **pre-existed and was kept in the implementing legislation**. However, it only concerns artistic works and their inclusion in films and emissions; the definition of film is however rather broad and could arguably be interpreted as covering video footages<sup>1499</sup>.

**Czech Republic:** the exception **has been introduced in the Copyright Act**<sup>1500</sup>.

**Denmark:** the exception **was only partly adopted**, as it only covers reproductions of subordinate importance of works of art in newspapers, and in periodicals, film, radio or television as part of reporting current events; this will certainly not always be applicable to UGC materials<sup>1501</sup>.

**Estonia:** the incidental inclusion exception **was as such not introduced in the law**. A provision inspired from the exception of article 5.3 (h) (architectural works or sculptures in public places) may provide some relief, but in a limited number of UGC cases only<sup>1502</sup>.

**Finland:** the Copyright Act, which has adopted almost all exceptions from the Copyright Directive, **already provided for an exception for the incidental inclusion of works**; the formulation of the exception, even if slightly different from the Copyright Directive, was not modified<sup>1503</sup>.

**France:** the law **does not provide for an incidental inclusion exception**. However, courts do accept to apply such exception (thus, a judicial exception) in specific cases<sup>1504</sup>. Relating to the free reproduction or communication of works located in a public place, there has been numerous case law and especially decisions of the Cour de cassation.

---

1498 Copyright in the information society – A Guide to National Implementation of the European Directive, edited by B. Lindner & T. Shapiro, Edward Elgar Publishing Ltd, 2011 (Chapter on Bulgaria, by V. Sokolov), p. 111.

1499 Institute for Information Law (IVIR), Study on the implementation and effect in Member States' laws of Directive 2001/29/EC on the harmonization of certain aspects of copyright and related rights in the information society, Part II, Country reports, G. Westkamp, Final report, February 2007, p.143.

1500 Copyright in the information society – A Guide to National Implementation of the European Directive, edited by B. Lindner & T. Shapiro, Edward Elgar Publishing Ltd, 2011 (Chapter on the Czech Republic, by L. Pressburgerova & J. Tajbr), p. 146; Institute for Information Law (IVIR), Study on the implementation and effect in Member States' laws of Directive 2001/29/EC on the harmonization of certain aspects of copyright and related rights in the information society, Part II, Country reports, G. Westkamp, Final report, February 2007, p. 92.

1501 Institute for Information Law (IVIR), Study on the implementation and effect in Member States' laws of Directive 2001/29/EC on the harmonization of certain aspects of copyright and related rights in the information society, Part II, Country reports, G. Westkamp, Final report, February 2007, p.163; Copyright in the information society – A Guide to National Implementation of the European Directive, edited by B. Lindner & T. Shapiro, Edward Elgar Publishing Ltd, 2011 (Chapter on Denmark, by P. Schonning), p. 168.

1502 Copyright in the information society – A Guide to National Implementation of the European Directive, edited by B. Lindner & T. Shapiro, Edward Elgar Publishing Ltd, 2011 (Chapter on Estonia, by V. Naslund), p. 177.

1503 Copyright in the information society – A Guide to National Implementation of the European Directive, edited by B. Lindner & T. Shapiro, Edward Elgar Publishing Ltd, 2011 (Chapter on Finland, by K. Harenko), p. 191; Institute for Information Law (IVIR), Study on the implementation and effect in Member States' laws of Directive 2001/29/EC on the harmonization of certain aspects of copyright and related rights in the information society, Part II, Country reports, G. Westkamp, Final report, February 2007, p. 197.

1504 Copyright in the information society – A Guide to National Implementation of the European Directive, edited by B. Lindner & T. Shapiro, Edward Elgar Publishing Ltd, 2011 (Chapter on France, by P. Kamina), p. 213.

Two isolated decisions (in 2001) were dealing with a judicial exception for incidental inclusion as such<sup>1505</sup>. The Cour de Cassation also affirmed the existence of such a limitation in the sense of the Info Soc Directive in its decision of 12 May 2011<sup>1506</sup>.

**Germany: a similar exception already existed and was not modified**<sup>1507</sup>. It permits such inclusion of works if it proves unavoidable (which is not exactly the wording of the Copyright Directive)<sup>1508</sup>.

**Greece:** the legislator **decided not to introduce the incidental inclusion exception** when implementing the Copyright Directive<sup>1509</sup>.

**Hungary:** the exception **was not introduced in the legislation**. However, even though such case has not yet been dealt with by case-law, *“it is probable that, in certain obvious cases, the use of works and objects of related rights in a way that it does not have real relevance from the viewpoint of the exploitation of these rights – and is thus incidental – could be regarded as permitted on the basis of the “de minimis” principle (according to which very small (“minimal”) takings are so unsubstantial that they do not infringe the exclusive rights of the rightholder, which also means that courts should not be called upon to issue injunctions or award damages for such insignificant acts)”*<sup>1510</sup>. Also, the exception of article 5.3. (h) of the Copyright Directive may be of some limited relief, for some UGC works.

**Ireland:** Section 52 of the Copyright Act **allows for the incidental inclusion of works** or performances provided that such inclusion does not result in unreasonable prejudice to the copyright owner<sup>1511</sup>.

**Italy:** the exception **was not transposed** when implementing the Copyright Directive<sup>1512</sup>.

**Latvia:** the exception **was not transposed** when implementing the Copyright Directive<sup>1513</sup>.

**Lithuania:** the exception **was not transposed, even if** an exception exists for the reproduction of public works of architecture and sculptures made to be located permanently in public places, and when the reproduction is not main subject of representation and not done for direct or indirect economic advantage (article 28 of the Copyright Law

---

1505 For more details on that point, see the study of the Max Planck Institute on “Balancing Copyright – A survey of National Approach” (Reto Hilty and Sylvie Nerisson Ed. , MIP Studies on Intellectual Property and Competition Law, vol. 18, Springer, 2012), and the French report by Sylvie Nerisson (p. 387-429).

1506 “Etre et Avoir”, R.T.D.Com. 2011, p. 553, obs. Pollaud-Dulian.

1507 Copyright in the information society – A Guide to National Implementation of the European Directive, edited by B. Lindner & T. Shapiro, Edward Elgar Publishing Ltd, 2011 (Chapter on Germany, by M. Schaefer) p. 223.

1508 Institute for Information Law (IVIR), Study on the implementation and effect in Member States’ laws of Directive 2001/29/EC on the harmonization of certain aspects of copyright and related rights in the information society, Part II, Country reports, G. Westkamp, Final report, February 2007, p. 229.

1509 Copyright in the information society – A Guide to National Implementation of the European Directive, edited by B. Lindner & T. Shapiro, Edward Elgar Publishing Ltd, 2011 (Chapter on Greece, by E. Vagenas), p. 243.

1510 Copyright in the information society – A Guide to National Implementation of the European Directive, edited by B. Lindner & T. Shapiro, Edward Elgar Publishing Ltd, 2011 (Chapter on Hungary, by M. Ficsor), p. 265.

1511 Copyright in the information society – A Guide to National Implementation of the European Directive, edited by B. Lindner & T. Shapiro, Edward Elgar Publishing Ltd, 2011 (Chapter on Ireland, by L. Scales), p. 288.

1512 Copyright in the information society – A Guide to National Implementation of the European Directive, edited by B. Lindner & T. Shapiro, Edward Elgar Publishing Ltd, 2011 (Chapter on Italy, by S. Ercolani), p. 316.

1513 Copyright in the information society – A Guide to National Implementation of the European Directive, edited by B. Lindner & T. Shapiro, Edward Elgar Publishing Ltd, 2011 (Chapter on Latvia, by J. Bordans & I. Veiksa), p. 330.

**Luxembourg:** the exception **was not introduced; however**, a provision inspired from the exception of article 5.3 (h) (architectural works or sculptures in public places) may provide some relief, but in a limited number of UGC cases only<sup>1514</sup>.

**Malta:** the exception **pre-existed the Copyright Directive and was not modified**, even if the wording is slightly different<sup>1515</sup>.

**The Netherlands:** the **incidental inclusion exception was added, after quite some controversies**, for fear that it might be interpreted as “accidental” or “unintentional” and that its contours were vague. Some case-law does exist. A study commissioned by the Ministry of Justice in 2007 concluded that this exception was of little value to Dutch copyright (we could not verify if the added value for UGC was part of the issues analyzed by the report)<sup>1516</sup>.

**Poland :** it **does not seem that the exception has been introduced** under Polish law<sup>1517</sup>.

**Portugal:** the **exception was added to the text by the Parliament**, even if it had not been proposed by the Bill submitted by the Government<sup>1518</sup>.

**Romania:** the exception **was not taken over** in the Copyright Act when implementing the Copyright Directive<sup>1519</sup>.

**Slovak Republic:** the exception **was not taken over** in the Copyright Act when implementing the Copyright Directive<sup>1520</sup>.

**Slovenia:** it **does not seem that the exception was introduced**<sup>1521</sup>.

**Spain:** the **exception was not introduced**<sup>1522</sup>. What is however allowed is the dissemination of works capable of being seen or heard in connection with news reporting (which must be the purpose of the dissemination)<sup>1523</sup>.

---

1514 Copyright in the information society – A Guide to National Implementation of the European Directive, edited by B. Lindner & T. Shapiro, Edward Elgar Publishing Ltd, 2011 (Chapter on Luxembourg, by K. Manhaeve & Th. Schiltz), p. 369.

1515 Institute for Information Law (IVIR), Study on the implementation and effect in Member States' laws of Directive 2001/29/EC on the harmonization of certain aspects of copyright and related rights in the information society, Part II, Country reports, G. Westkamp, Final report, February 2007, p. 339.

1516 A summary of this report is available at <http://www.wodc.nl/onderzoeksdatabase/de-minimis-regelingen-in-het-auteursrecht-haalbaar-en-wenselijk.aspx>; Copyright in the information society – A Guide to National Implementation of the European Directive, edited by B. Lindner & T. Shapiro, Edward Elgar Publishing Ltd, 2011 (Chapter on the Netherlands, by A. Quaedvlieg), p. 417. See also, Institute for Information Law (IVIR), Study on the implementation and effect in Member States' laws of Directive 2001/29/EC on the harmonization of certain aspects of copyright and related rights in the information society, Part II, Country reports, G. Westkamp, Final report, February 2007, p. 357.

1517 Copyright in the information society – A Guide to National Implementation of the European Directive, edited by B. Lindner & T. Shapiro, Edward Elgar Publishing Ltd, 2011 (chapter on Poland, by W. Z. Dziomdziora), p. 427.

1518 Copyright in the information society – A Guide to National Implementation of the European Directive, edited by B. Lindner & T. Shapiro, Edward Elgar Publishing Ltd, 2011 (Chapter on Portugal, by P. Akester), p. 447.

1519 Copyright in the information society – A Guide to National Implementation of the European Directive, edited by B. Lindner & T. Shapiro, Edward Elgar Publishing Ltd, 2011 (Chapter on Romania, by M. Voican), p. 467.

1520 Copyright in the information society – A Guide to National Implementation of the European Directive, edited by B. Lindner & T. Shapiro, Edward Elgar Publishing Ltd, 2011 (Chapter on the Slovak Republic, by S. Olsovsky), p. 493.

1521 Copyright in the information society – A Guide to National Implementation of the European Directive, edited by B. Lindner & T. Shapiro, Edward Elgar Publishing Ltd, 2011 (Chapter on Slovenia, by M. Trampuz), p. 508.

1522 Copyright in the information society – A Guide to National Implementation of the European Directive, edited by B. Lindner & T. Shapiro, Edward Elgar Publishing Ltd, 2011 (Chapter on Spain, by M.G. Leon), p. 516.

**Sweden: a new provision (broader in scope than the pre-existing one) was added**, allowing for the inclusion in a film, a television programme or a picture of a copy of a work of fine arts if the exploitation is of minor importance<sup>1524</sup>.

**United Kingdom: the incidental inclusion exists** under Section 31 CDPA, no amendment has been made to the text<sup>1525</sup>.

### 3. General observations on the incidental use exception:

This exception may provide some relief to UGC works yet there are many limits to its utility:

- It is not implemented at all in some Member States :
  - o Austria, Bulgaria, the Czech Republic, Greece, Italy, Latvia, Poland, Romania, the Slovak Republic, Slovenia, did not implement the exception;
  - o Finland, Germany, Ireland, Malta, the Netherlands, Portugal, Sweden and the United Kingdom did;
  - o France accepts it in court decisions but the law does not mention the exception; the same seems to more or less apply in Hungary;
- Its inclusion via article 5.3. (h) limits in many countries its scope of application to architectural works and sculptures (fine arts mainly) but can hardly be said to apply to music and “remix” for instance (Belgium, Estonia, Lithuania, Luxembourg).
- Sometimes, the purpose of the inclusion must be for reporting on current events (Denmark, Spain).

The overall picture is thus of a rather disharmonized situation, providing little certainty and difficult implementation schemes for pan-European UGC works.

We will discuss in the second part of our Study whether some relief for UGC works could usefully be found in the adaptation of this exception.

## VIII. Overview of some recent case law on UGC

### A. Relevant case law of the EUCJ

There is no case law of the EUCJ concerning cases of UGC. However, its case law in the field of copyright has been quite prolific in the last few years. The present section aims at determining whether the findings of the Court can provide useful clues in order to clarify the current legal status of UGC under European Law.

#### 1. The interpretation of the exceptions

We have already examined in this Study the exceptions to copyright that may the most likely be applicable to the creation and publication of User Generated Content. Without entering here into the

<sup>1523</sup> Institute for Information Law (IVIR), Study on the implementation and effect in Member States' laws of Directive 2001/29/EC on the harmonization of certain aspects of copyright and related rights in the information society, Part II, Country reports, G. Westkamp, Final report, February 2007, p. 424.

<sup>1524</sup> Institute for Information Law (IVIR), Study on the implementation and effect in Member States' laws of Directive 2001/29/EC on the harmonization of certain aspects of copyright and related rights in the information society, Part II, Country reports, G. Westkamp, Final report, February 2007, p. 434.

<sup>1525</sup> Copyright in the information society – A Guide to National Implementation of the European Directive, edited by B. Lindner & T. Shapiro, Edward Elgar Publishing Ltd, 2011 (Chapter on the United Kingdom, by T. Aplin), p. 572.



details of each individual exception, this section explains the general principles set out by the EUCJ for the interpretation of the exceptions in general.

A first well-established principle is the **strict interpretation** of exceptions. The reasons behind this principle were recalled by the Court, i.a. in the *Painer*<sup>1526</sup> decision:

- the principal purpose of Directive 2001/29 is to establish a high level of protection for, in particular, authors, which is crucial to intellectual creation and this purpose may not be compromised by the national implementation of exceptions;
- the exceptions must comply with the need for legal certainty for authors with regard to the protection of their works;
- the exceptions derogate from the general principle established by directive 2001/29, namely the requirement of authorisation from the copyright holder for any reproduction of a protected work and must, according to settled case-law, be interpreted strictly;
- the three-step test provides additional requirements, with which exceptions must comply.

A strict application of this principle led the Court to set out, in *Painer*, that the exception for public security could only be invoked by national authorities in charge of the security and not by newspapers on their own account. The Court provides its own interpretation of the directive, even if the wording of the exception does not expressly address the circumstances in which the interests of public security can be invoked with a view to the use of a protected work.

In *Infopaq International*<sup>1527</sup>, in *Football Association Premier League Ltd*<sup>1528</sup>, and in *Karen Murphy v. Media Protection Services Ltd*<sup>1529</sup>, the EUCJ reiterated this principle of a strict interpretation in relation to the transient reproduction exemption.

These recent cases nonetheless saw the Court somehow mitigating the principle of strict interpretation by recognising **the need to enable the effectiveness of the exception**. Following a teleological approach, the Court verified whether the proposed interpretation of the exceptions complied with their purpose and did not hinder their effectiveness in this regard. For instance, according to the Court, the purpose of the transient reproduction exception is to allow and ensure the development and operation of new technologies while safeguarding a fair balance between the rights and interests of right holders and users of the protected works. The interpretation of the conditions of the exceptions should help preserve the effectiveness of the exception and respect its purpose<sup>1530</sup>.

In the *Painer* decision, the Court seemed to move one step beyond and made a **balance of interests** between the exclusive rights of the authors and the interests protected by the purpose of an exception. The Court held that the exception of quotation was “*intended to strike a fair balance between the right to freedom of expression of users of a work or other protected subject-matter and the reproduction right conferred on authors*” and that in such case, “*the fair balance is struck by favouring the exercise of the users’ right to freedom of expression over the interest of the author in being able to prevent the*

---

1526 Judgement of the Court of 1st December 2011, in Case C-145/10, *Eva-Maria Painer v. Standard VerlagsGmbH, Axel Springer AG, Süddeutsche Zeitung GmbH, Spiegel-Verlag Rudolf Augstein GmbH & Co KG, Verlag M. DuMont Schauberg Expedition der Kölnischen Zeitung GmbH & Co KG*.

1527 *Infopaq International A/S v. Danske Dagblades Forening*, 16 July 2009, C-5/08, §56.

1528 *Football Association Premier League Ltd, NetMed Hellas SA, Multichoice Hellas SA v. QC Leisure, David Richardson, AV Station plc, Malcolm Chamberlain, Michael Madden, SR Leisure Ltd, Philip George Charles Houghton, Derek Owen* (C-403/08), §62.

1529 *Karen Murphy v. Media Protection Services Ltd* (C-429/08), 4 October 2011.

1530 *Football Association Premier League*, §133.

*reproduction of extracts from his work which has already been lawfully made available to the public, whilst ensuring that the author has the right, in principle, to have his name indicated*<sup>1531</sup>.

Based on these considerations, the Court refused the application of an additional requirement going beyond the conditions set out by the text of the directive to qualify for the exception of quotation, i.e. the Court did not require that the quotation be part of a “work”<sup>1532</sup>.

It is unclear whether this reasoning is only an application of the Court’s recently-established requirement to ensure the effectiveness of exceptions, or if the Court made a special treatment for those of the exceptions which are useful for the putting into practice of fundamental rights. Interestingly, in the latter case, one could imagine that the Court will hold a similar reasoning in future cases involving the exception of caricature and parody, the purpose of which being clearly the exercise of the freedom of expression, just like the exception of quotation.

## **2. The margin enjoyed by the Member States in the implementation and the interpretation of the exceptions**

Articles 2 and 3 of Directive 2001/29 set out an “*exhaustive enumeration of exceptions and limitations to the right of reproduction and the right of communication to the public*”<sup>1533</sup>. This list of exceptions is closed and optional for the Member States, apart from the exception for certain acts of temporary reproduction which is mandatory.

Furthermore, the wording of most exceptions is relatively vague and it has been argued that they constitute prototypes for national lawmaking rather than precisely circumscribed exceptions with no inherent flexibility<sup>1534</sup>. Many exceptions use broad concepts for which no definition is provided and most of the time the conditions to benefit from the exceptions are not precisely set out. The combination of the optional character of the exception and the inherent flexibility of their wording led to different national implementation strategies across the Member States<sup>1535</sup>. We have already examined in this Study the differences in the implementation of three exceptions in the Member States.

The margin enjoyed by the Member States in implementing the exceptions is however limited by the principle of strict interpretation (as arguably mitigated by the EUCJ in the Painer decision), explained in the previous section, and by the three-step test set out by the directive. Member States must therefore restrain from broadening the scope of the exceptions while implementing them.

The optional character of the exceptions led therefore to the usual interpretation according to which Member States would be free to specify the limits of the exceptions. If the Member States are allowed not to implement certain exceptions while not being allowed to broaden their scope, it seems quite logical to allow the Member States to limit the scope of the exceptions and/or to specify additional conditions for their application.

---

1531 Painer, §134-135.

1532 On another note, one might nonetheless query how this interpretation favors “expression” if the communication in which the quotation appears is not itself expressive (of anything other than the quotation). Does this suggest that the EUCJ’s concept of “expression” embraces the mere reiteration of others’ expressions? Some U.S. commentators (e.g., Rebecca Tushnet), do argue that repeating others’ expressions without adding any expression of one’s own nonetheless constitutes “freedom of expression,” but the US Supreme Court has so far not found such contentions convincing. See e.g., *Eldred v Ashcroft* (“freedom of speech” primarily means “freedom to make one’s own speech”, not to repeat the speech of others).

1533 Recital 32 of directive 2001/29

1534 M. Senftleben, “Beperkingen à la carte: Waarom de Auteursrechtlijn ruimte laat voor fair use”, *AMI/Tijdschrift voor auteurs-, media en informatierecht*, 2003, p.10.

1535 B. Hugenholtz and M. Senftleben, “Fair use in Europe. In search of flexibilities”

The Court recalled, in Painer: “*the provisions of Directive 2001/29 do not expressly address the circumstances in which the interests of public security can be invoked with a view to the use of a protected work, meaning that the Member States which decide to enact such an exception enjoy a broad discretion in that respect.*”

*In fact, such a discretion is, first, in accordance with the idea that each Member State is best placed to determine, in accordance with its national needs, the requirements of public security, in the light of historical, legal, economic or social considerations specific to it.*

*Secondly, that discretion is consistent with the Court’s case-law to the effect that, in the absence of sufficiently precise criteria in a directive to delimit the obligations thereunder, it is for the Member States to determine, in their own territory, what are the most relevant criteria for ensuring compliance with that directive.”<sup>1536</sup>*

However, outside the context of public security, different principles set out by the recent case-law seem to limit significantly the “broad discretion” recognized by the Court to the Member States.

First, the exceptions must be implemented while bearing in mind the **need for harmonization**. The Court considers that exceptions should be implemented according to the objectives of the Directive 2001/29, which includes ensuring that competition in the internal market is not distorted as a result of Member States’ different legislations. In the Padawan case<sup>1537</sup> concerning private copying, the Court held that “*The European Union legislature’s aim of achieving the most uniform interpretation possible of Directive 2001/29 is apparent in particular from recital 32 in the preamble thereto, which calls on the Member States to arrive at a coherent application of the exceptions to and limitations on reproduction rights, with the aim of ensuring a functioning internal market*”<sup>1538</sup>. As a consequence, the Member State are not free to set out the boundaries of the notion of “fair compensation”: “*An interpretation according to which Member States which have introduced an identical exception of that kind, provided for by European Union law and including, [...] the concept of ‘fair compensation’ as an essential element, are free to determine the limits in an inconsistent and un-harmonised manner which may vary from one Member State to another, would be incompatible with the objective of that directive*”<sup>1539</sup>. The Court held a similar reasoning in DR et TV2 Danmark<sup>1540</sup>.

Then, the Court emphasized the **need to enable the effectiveness of the exception** in a certain number of recent cases including Infopaq, Premier League and Painer. Therefore, even if Member States are free to implement an optional exception of a European directive, they are not allowed to undermine the objectives of the exception in the directive while implementing it. In Painer, the Court seemed to consider that the need to enable the effectiveness of the exception of quotation opposed adding any other conditions to its application than those explicitly mentioned in the text of the directive. The Court considered that the exception strikes “*a fair balance between the right of freedom of expression of users of a work [...] and the reproduction right conferred on authors*”, which balance is “*struck by favouring the exercise of the users’ right to freedom of expression over the interest of the author*”<sup>1541</sup>. The room for freedom in national implementation is therefore completely undermined in this case.

As we indicated above, it is unclear whether the Court tended to consider the text of the exception as “self-sufficient” and preventing additional limitations and conditions imposed by the Member States only

---

1536 Painer, §101-103.

1537 Judgement of the Court of 21 October 2010, in Case C-467/08, Padawan SL v. Sociedad General de Autores y Editores de España (SGAE).

1538 Padawan, §35.

1539 Padawan, §36.

1540 CJUE., 26 avril 2012, DR et TV2 Danmark, C-510/10, §36.

1541 Painer, §134-135

because the exception at stake involved fundamental rights (freedom of expression) or if the Court could hold a similar reasoning in cases concerning exceptions covering other purposes – yet for this Study and the three exceptions under examination, this question is not decisive.

In any case, this case-law questions to a certain extent the optional character of the exceptions themselves. It seems indeed hard for a Member State to choose not to implement an exception that is specifically designed and balanced, according to the Court, to enforce the freedom of expression of users of copyright protected material.

These principles must be combined with the recent tendency of the EUCJ to **harmonize various concepts** of the Directive 2001/29 that the Directive did not seek to define precisely. Although the Court held in the *Sena* case of 2003<sup>1542</sup> that the concept of equitable remuneration had an autonomous meaning, it specified that “*the Court's role, in the context of a dispute brought before it, can only be to call upon the Member States to ensure the greatest possible adherence throughout the territory of the Community to the concept of equitable remuneration*” and the Court consequently declined to provide the appropriate criteria to determine the material content of the notion, leaving this task to the Member States.

In more recent cases, the need for a uniform application of the European Law to give an autonomous meaning to the concepts used by European instruments, unless they contain explicit references to national laws, was frequently highlighted and used by the Court to provide its own interpretation of the material content of various concepts. In the field of copyright, the Court gave its own autonomous interpretation of, amongst others, the concepts of fair compensation<sup>1543</sup>, of reproduction and originality<sup>1544</sup>, of communication to the public<sup>1545</sup>.

It is therefore **difficult to draw clear conclusions** on the margin of freedom enjoyed by the Member States' legislators in the implementation of the exceptions, and by the national courts in their interpretation. A too broad interpretation would run counter to the principle of strict interpretation and the three-step test. A too narrow interpretation would threaten the effectiveness that must be given to the exceptions. Adding conditions to benefit from the exceptions may jeopardize the objective of harmonization in the internal market and may be contrary to the balance of interests that the text of the directive intended to make without saying so. Finally, the EUCJ may suddenly discover an autonomous meaning to the concepts used in the broad wording of article 5 of the Directive and provide its own interpretation of their material content.

## B. National case law on UGC

We could only identify two cases dealing specifically with UGC, both taking place in the USA. We also included in this section the presentation of two cases concerning *sampling*; although the facts concerned professionals and not “Users” in the sense used in this Study, the reasoning followed by the courts with regard to sampling is worth noting because many pieces of UGC make comparable uses of copyrighted works.

---

1542 CJUE, 6 February 2003, C-245/00, *Sena*

1543 *Padawan*.

1544 CJUE, 16 July 2009, C-5/08, *Infopaq*.

1545 CJUE, 7 December 2006, C-306/05, *SGAE v. Rafaelles* and CJUE, 15 March 2012, C-135/10, *Società Consortile Fonografici (SCF) v Marco Del Corso*.

## 1. Lenz v. Universal<sup>1546</sup>

The facts giving rise to this US case are extremely simple and very illustrative of common uses of the Internet for publishing UGC. On February 7, 2007, Stephanie Lenz videotaped her young child in her family's kitchen. The song "Let's Go Crazy" by the artist known as "Prince" played in the background. During the video, Lenz's son is shown walking with the aid of a push-toy and "dancing" to the song. Lenz can be heard asking "what do you think of the music?" On February 8, 2007, Lenz uploaded the twenty-nine second video to YouTube.com ("YouTube"), a popular Internet video hosting site. She titled the video "Let's Go Crazy #1."

Universal is a well-known music publishing company which manages the copyrights for the singer Prince. On June 4, 2007, apparently on Prince's insistence<sup>1547</sup>, Universal sent a Takedown Notice to YouTube, in order to have Lenz's video taken offline. On the same day, YouTube sent Lenz an email notifying her that it had removed her "Let's Go Crazy #1" video in response to Universal's accusation of copyright infringement.

Lenz sent YouTube a DMCA counter-notice on June 27, 2007. That counter-notice asserted that the video constituted fair use of "Let's Go Crazy." YouTube restored the video to its site in mid-July 2007; the video was therefore down for approximately six weeks. Furthermore, Lenz filed an action against Universal in July 2007. Lenz claimed that Universal's Takedown Notice was a "notification of claimed infringement" pursuant to the DMCA, but that it constituted a knowing, material misrepresentation that her video infringed Prince's copyright, and that she incurred damages as a result of YouTube's removal of her video from its site.

The elements of facts submitted to the Court showed that Universal's employees in charge of sending takedown notice to YouTube only verify whether uploaded videos contains significant use of a copyrighted composition, if the song is recognizable, if it is in a significant portion of the video or is the focus of the video. They do not, however, consider specifically the possibility that the concerned videos make fair use of copyrighted works before issuing a takedown notice.

The Court held that, in order for a copyright owner to proceed under the DMCA with "a good faith belief that use of the material in the manner complained of is not authorized by the copyright owner, its agent, or the law," the owner must evaluate whether the material makes fair use of the copyright.

Universal argued that although a thorough analysis of fair use had not been made by its employees, they considered whether Lenz's video made "significant use" of Prince's song and whether the song was the "focus" of the video, which are relevant factors under the fair use doctrine.

The Court disagreed that it was sufficient for a copyright holder to consider facts that might be relevant to a fair use analysis without making any effort to evaluate the significance of such facts in the context of the doctrine itself. Because the question of whether something constitutes fair use is a "legal judgment," proper consideration of the doctrine must include at least some analysis of the legal import of the facts. The Court concluded that at minimum, a copyright owner must make at least an initial assessment as to whether the fair use doctrine applies to the use in question in order to make a good faith representation that the use is not "*authorized by law*."

---

1546 Stephanie Lenz v. Universal Music Corporation, Universal Music Publishing, INC and Universal Music Publishing Group, Order of January 24, 2013 denying cross-motions for summary judgement, US District Court for the northern district of California, San Jose division, Case N°5:07-cv-03783-JF ; available on the website of the Electronic Frontier Foundation: <https://www.eff.org/sites/default/files/filenode/LenzOrderDenyingMSJs.pdf>

1547 Prince was apparently offended by the trivializing of his music. In other words, although the U.S. court did not so understand it, Lenz is to a large extent a moral rights case. The facts suggest that without Prince's insistence, Universal would not have sent the take-down notice. In a sense, acknowledgment of the source ("Let's Go Crazy") made things worse than if no such mention had been added, because it seems clear that Prince did not want to be associated with the Cute Baby video.

The Court further decided that Mrs Lenz could not demonstrate that Universal “*wilfully blinded itself*” to the potential application of the fair use doctrine and, on the other hand, that Universal could not establish that Mrs Lenz had not suffered any damage. As a consequence, the Court refused to issue a summary judgment which would have closed the case. The litigation will therefore likely continue to the next step, probably a trial before a jury. Even if sometimes presented as an “incidental inclusion” case, it is more of a remix case: the music playing in the background was not there “incidentally” during the video shooting – see Lenz’ calling attention to the music on the sound track of the video

## 2. Warner Bros. and J. K. Rowling v. RDR Books<sup>1548</sup>

In the so-called “*Lexicon*” case, the legality of an encyclopaedia based upon the famous “Harry Potter” series of novels written by J.K. Rowling was challenged. Strictly speaking, this case is not as such a UGC case, except *a contrario*, since J.K. Rowling had not opposed a (UGC) fan fiction website but did oppose to the publishing of a book based on this website.

The Lexicon was born from the efforts of an American librarian and faithful Harry Potter fan named Steven Vander Ark. After he read the second tome of the Harry Potter series, Vander Ark created a website devoted to cataloguing every character, item, spell, and fact of the Harry Potter world, with comprehensive examples and references to the novels and to side materials including other books and interviews of J.K. Rowling. Vander Ark and the community of Harry Potter fans continued to enrich the Lexicon website as the following tomes of the series were published. The website was very successful and attracted impressive numbers of visitors. In June 2004, J.K. Rowling herself awarded the site her “J.K. Rowling Fan Site Award” and said in an interview that she occasionally referred to the website rather than to her own books in order to check a fact or a reference.

However, she changed her initial good feelings quite drastically when Steven Vander Ark was convinced by a publishing company, *RDR Books*, to release and commercialize the Lexicon in a printed form, after RDR Books had guaranteed that such publication would not infringe J.K. Rowling’s copyright and accepted to bear all defence costs in case of legal actions.

After unsuccessful attempts to reach an amicable settlement, J.K. Rowling and Warner Bros, the owner of copyright in the Harry Potter movies and video games, initiated legal proceedings in 2007 in order to obtain an injunctive order against the commercialization of the Lexicon.

The court verified first whether the Lexicon was found to infringe the plaintiffs’ copyrights, and then examined if the defendants could invoke fair use defence to justify their use of J.K. Rowling’s original materials, including mainly the “Harry Potter” series and two other books, “*Quidditch Through the Ages*” and “*Fantastic Beasts and Where to Find Them*”.

The first alleged copyright infringements were acts of unauthorized copying. The defendants did not dispute the actual copying of fragments of J.K. Rowling’s books, but according to U.S. Law, the Court had to verify further whether such copying was “quantitatively and qualitatively sufficient” to conclude to the existence of “substantial similarity” between the original and the later works. The Court found that the Lexicon contained a substantial amount of verbatim or slightly paraphrased extracts of the original books. The description of fictional facts created by J.K. Rowling and summaries of key events and scenes extracted from the books were also considered as substantial copies: “*Notwithstanding the dissimilarity in the overall structure of the Lexicon and the original works, some of the Lexicon entries contain summaries of certain scenes or key events in the Harry Potter series, as stated in the Findings of Fact. These passages, in effect, retell small portions of the novels, though without the same dramatic effect. In*

---

<sup>1548</sup> Warner Bros. Entertainment, Inc. and J. K. Rowling vs. RDR Books (575 F.Supp.2d 513), decision of September 8, 2008 of the United States District Court, Southern District of New York, available at <http://cyberlaw.stanford.edu/files/blogs/Lexicon%20Order.pdf> ; also see comments of A. J. Sanders, “J.K. Rowling and The Lexicon: Warner Bros. Entertainment Inc. and J.K. Rowling v. RDR Books, et al.”, EIPR, 2009, p. 45.

*addition, the entries for Harry Potter and Lord Voldemort give a skeleton of the major plot elements of the Harry Potter series, again without the same dramatic effect or structure. Together these portions of the Lexicon support a finding of substantial similarity*<sup>1549</sup>.

The Court concluded therefore to the existence of a copy prohibited by copyright; the fact that such elements were primarily used in their “factual capacity”, to report information and where to find it was found important to examine the question of fair use at a later stage, but not to assess the existence of a copy<sup>1550</sup>.

Interestingly, the Court examined then whether the Lexicon could also be qualified as a “derivative work” of J.K. Rowling’s original books. As in the Berne Convention, the right of reproduction and the right of adaptation (the right to create derivative works) are recognized as separate prerogatives in the U.S. Copyright law. The Court reminded that a work is not derivative simply because it is “based upon” the preexisting works; the statutory language seeks to protect works that are “recast, transformed, or adapted” into another medium, mode, language, or revised version, while still representing the “original work of authorship.” J.K. Rowling and Warner Bros argued that the Lexicon was a derivative work, because it contained a substantial amount of material from the original books. The Court did not follow their position and ruled that “*More importantly, although the Lexicon “contain[s] a substantial amount of material” from the Harry Potter works, the material is not merely “transformed from one medium to another,” [...] By condensing, synthesizing, and reorganizing the preexisting material in an A-to-Z reference guide, the Lexicon does not recast the material in another medium to retell the story of Harry Potter, but instead gives the copyrighted material another purpose. That purpose is to give the reader a ready understanding of individual elements in the elaborate world of Harry Potter that appear in voluminous and diverse sources. As a result, the Lexicon no longer “represents [the] original work[s] of authorship.” 17 U.S.C. § 101. Under these circumstances, and because the Lexicon does not fall under any example of derivative works listed in the statute, Plaintiffs have failed to show that the Lexicon is a derivative work.*”<sup>1551</sup>

The Court finally had to examine whether the acts of copying made by the defendants could be justified under the fair use defence. A fair use analysis implies the evaluation of four criteria: (1) the purpose and character of the use, including whether such use is of a commercial nature or is for nonprofit educational purposes; (2) the nature of the copyrighted work; (3) the amount and substantiality of the portion used in relation to the copyrighted work as a whole, and (4) the effect of the use upon the potential market for or value of the copyrighted work. The evaluation of these factors is an “open-ended and context-sensitive inquiry” as the Court recalled ; they all must be explored, and the results weighed together, in light of the purposes of copyright, i.e. ‘promoting the Progress of Science and Useful Arts’<sup>1552</sup>.

As the Court balanced the fair use criteria against each other, in a very detailed analysis, it asserted that in its function a reference guide to a series like the “Harry Potter” novels can qualify as fair use. However, the Court ultimately decided that in the present case, the amount and substantiality of the portion of the original works used in the Lexicon exceeded what is necessary for its intended purpose of serving as a reference guide. The fair use defence was therefore not allowed.

Interestingly, the commercial nature of the secondary exploitation (the publication of the Lexicon) was not found to be an important criterion; it only weighted slightly against a finding of fair use. The Court granted more importance to the “Market Harm” factor, which requires examining whether the publication of the Lexicon was likely to affect the potential market for or value of the original copyrighted work, including the

---

1549 Warner Bros. Entertainment, Inc. and J. K. Rowling vs. RDR Books, page 37.

1550 That ruling was consistent with prior authority in the circuit rejecting the contention that summarizing “fictional facts” was merely reproducing unprotectable “information” about the works; see “Twin Peaks” and “Seinfeld Aptitude Test” cases.

1551 Warner Bros. Entertainment, Inc. and J. K. Rowling vs. RDR Books, page 40

1552 Idem, page 42

current and potential market for derivative works. The Court found that the publication of the Lexicon was not likely to have an impact on the market value of the “Harry Potter” novels because it serves a different and complementary purpose. Publishing the Lexicon would however more likely impair the sales of two other of J.K. Rowling’s books, “*Quidditch Through the Ages*” and “*Fantastic Beasts and Where to Find Them*”, the purpose of which being partly similar to the Lexicon’s.

Although the Court considered the Lexicon as infringing J.K. Rowling’s copyright, it made very clear that “*reference works that share the Lexicon’s purpose of aiding readers of literature generally should be encouraged rather than stifled*”<sup>1553</sup>. The decision relied on the circumstances of the case but is not to be interpreted broadly against this type of transformative use<sup>1554</sup>. Vander Ark and RDR Books themselves chose to re-write a new version of the Lexicon in order to comply with the legal issues highlighted by the decision.

For this Study concerning UGC, the most remarkable teaching of the *Lexicon* decision is – somewhat paradoxically - the deafening silence surrounding User Generated Content, especially UGC published on the Internet as such. As we explained in the introduction of this section, the Lexicon content was based upon the website of Steven Vander Ark, the extent of which going even beyond the content selected to make a printed version. Throughout the decision, a question is left completely unanswered: what about the legality of the website version of the Lexicon? The reason of this silence is easily explained: the Plaintiffs chose to act only against the publishing of a printed version of the Lexicon, but had no problem with the existence of the website, which J.K. Rowling even supported. The judge did not have to answer a question that was not asked by the parties. From a legal point of view, however, it is hard to know whether the reasoning of the Court would have been different when examining whether the Lexicon website was infringing J.K. Rowling’s copyright; one may think that this would probably have been the case, because many of the most “transformative” aspects of the website were Internet-specific, e.g., links to other sites.

At least, this case illustrates that some copyright owners, like J.K. Rowling, decide not to act against User Generated Content published on the internet but may change their mind when it comes to professional exploitation of such content under traditionally marketed forms, like printed books<sup>1555</sup>.

### 3. Side cases concerning sampling

Although not explicitly dealing with UGC, there is a lot of case law on music sampling, which pre-existed UGC and lead to quite some opposition by music publishers and record labels<sup>1556</sup>.

In the US case **Bridgeport Music, Inc. v. Dimension Films**<sup>1557</sup>, Bridgeport and Westbound claimed to own the musical composition and sound recording copyrights in “Get Off Your Ass and Jam” (“Get Off”) by George Clinton, Jr. and the Funkadelics. Samples of this song were included in the rap song “100 Miles and Runnin’” (“100 Miles”), which was itself included in the sound track of the movie *I Got the Hook Up* (Hook Up), published by Dimension Films. Bridgeport claimed that such use of portions of the song “Get Off” were copyright infringements.

---

1553 *Idem*, page 66

1554 In fact, the court did not find Van der Ark’s use (as a print book, as opposed to the website) sufficiently “transformative” to escape the accusation of copyright infringement.

1555 For a fuller discussion of the practice of forbearance against individual site operators, see Tim Wu, *Tolerated Use*, 31 *Columbia Journal of Law & the Arts* 617 (2008); also E. Lee, “Warming up to User-Generated Content”, available at [http://papers.ssrn.com/sol3/papers.cfm?abstract\\_id=1116671](http://papers.ssrn.com/sol3/papers.cfm?abstract_id=1116671).

1556 See generally Peter di Cola and Kembrew McLeod, *Creative License: The Law and Culture of Digital Sampling* (2011)

1557 *Bridgeport Music, Inc. v. Dimension Films*, decision of September 7, 2004 of the United States Court of Appeal for the sixth circuit, case N° 02-6521 and 03-5738, available online at <http://fsnews.findlaw.com/cases/6th/04a0297p.html>



More specifically, the recording “Get Off” opens with a three-note combination solo guitar “riff” that lasts four seconds. The recording “100 Miles” contains a sample from that guitar solo, i.e. a two-second sample from the guitar solo was copied, the pitch was lowered, and the copied piece was “looped” and extended to 16 beats. This sample appears in the sound recording “100 Miles” in five places and each looped segment lasts approximately 7 seconds.

The Court of Appeal reversed the decision of first instance, which had found the sampling not in violation of copyright law, and ruled that the sampling was infringing copyright. The Court highlighted that an owner of the copyright on a sound recording had exclusive right to duplicate the work, even in parts, and found no applicable statutory limitation of this right. There is no “*de minimis*” rule, according to the court, when it comes to sampling of sound recordings fixed on a medium, as opposed to small parts of musical compositions, because it is a physical taking rather than an intellectual one. In its decision, the court wrote a remarked statement: “Get a license or do not sample. We do not see this as stifling creativity in any significant way.”

It is however worth noting that the fair use defence was not invoked by the defendants, nor analysed by the Court of Appeal<sup>1558</sup>. Arguably, fair use defence would be at stake in future cases involving sampling, especially when user generated content produced by amateurs is concerned.

The US case-law seems however not consistent on the question of digital sampling. As a commentator noted, “*In digital sampling cases, the U.S. courts have utilized divergent legal tests with opposite outcomes with findings of liability and per se infringement in some cases to exceptions to liability under fair use and de minimis in other disputes*”<sup>1559</sup>.

The German case **Metall Auf Metall**<sup>1560</sup>, also known as the *Kraftwerk* decision<sup>1560</sup>, concerned a very similar case of music sampling. The court held that the quality or quantity of sampled material is irrelevant in the determination of whether there has been an infringement of a party’s exclusive right to reproduce and distribute their sound recording. It also ultimately held that if it is proven that any part of a protected sound recording has been copied without permission, then infringement has occurred.

It must however be noted that the decision is only based on the neighbouring rights that a music producer owns on a sound recording, and not on copyright on the musical composition. Copyright on the composition had been invoked by Kraftwerk before the lower court, which considered that examining this issue was not relevant for the solution of the dispute. The Supreme Court did not have to re-examine the issue, for procedural reasons.

This being said, the Court examined whether sampling could be justified under the German exception of “free use”<sup>1561</sup>, which was found to be applicable to both copyright and neighbouring rights. The Supreme

1558 The Bridgeport decision has been widely criticized; it is not clear that it represents the law in any Circuit other than the 6th Circuit.

1559 Robert C. Bird and Lucille M. Ponte, “Protecting moral rights in the United States and the United Kingdom: Challenges and opportunities under the U.K.’s new performances regulations”, Boston University International Law Journal, vol. 24:213, 2006, p. 214

1560 Kraftwerk, et al. v. Moses Pelham, et al., Decision of the German Federal Supreme Court no. I ZR 112/06 dated November 20, 2008 ; English translation of the decision and comments by N. Conley and T. Braegelmann can be found in Journal of Copyright Society of the U.S.A, 2009, p. 1017-1037 ; electronic version available at <http://ssrn.com/abstract=1504982>

1561 « Free use » is the literal translation of the German exception of “Freie Benutzung”, set out in section 24, paragraph 1, of the UrhG [German copyright act] which allows, in a nutshell, the publication and exploitation of independent work created by the free use of another person’s work. For more information, see 2007 Queen Mary study p.45 : [http://ec.europa.eu/internal\\_market/copyright/docs/studies/infosoc-study-annex\\_en.pdf](http://ec.europa.eu/internal_market/copyright/docs/studies/infosoc-study-annex_en.pdf)

Caricature, Parody and Pastiche:

“The Copyright Acts in Austria, Germany and Portugal contain a general ‘free use’ clause that is not restricted to the uses mentioned in Article 5(3)(k). In Germany, for instance, the ‘free use’ clause does not exempt certain uses but reflects a general principle in that certain derivative or transformative works will not infringe. In this respect, the free use clause represents not a limitation but

Court did not definitely settle this issue in the *Kraftwerk* case, because not all relevant information was present in the decision of the lower court to determine whether the exception was applicable. The Court seemed however to indicate that, with regard to neighbouring rights, the exception should not be invoked by someone who is able to record its own version of the borrowed sounds, rather than copying samples of existing recordings. This rather narrow interpretation of the exception of “Free use” in the field of neighbouring rights may have a chilling effect on sampling in general, as the Court did not explain how to determine whether the users of samples “could have produced the appropriated rhythm sequence themselves”.

One must note however that both the Bridgeport and the Kraftwerk cases are related to professional musicians (NWA and Sabrina Setluer, respectively) – and the same holds true for the book version of the Harry Potter Lexicon mentioned above, published by a professional publisher - so that the analogy with UGC is debatable (also, both of the uses occurred before the emergence of the Web 2.0)<sup>1562</sup>.

To our knowledge, apart from the Lenz case, there appears to be no court case assessing the implication of fair use (or, in Europe, of existing copyright exceptions) to UGC.

## IX. A chilling effect of the actual legal framework?

It has quite often been said that the divergences in the existing exceptions, together with the absence of a specific exception for UGC, has a chilling effect on the development of UGC. Such assessment is hard to make as, by definition, UGC projects which have been so “chilled” as to not come into existence, have been abandoned, maybe forgotten and there may not be many candidates UGC creators still willing or still around to tell the rest of the world about their failed experience. So, it is an economic study or a market survey but not a legal study which could provide trustful data on this. A legal report as this one can review the case-law, the articles published on these topics (some of which assert but do not demonstrate a chilling effect) but it was not in the scope of our Study to try and find UGC projects which did not materialize due to a “chilling effect” coming from the actual legal framework; by doing so, one must admit that the legal study might only see the visible part of the iceberg – if an invisible part exists (or if, instead of an iceberg, UGC is more of an ice floe).

At the outset, one may observe that if there is a chilling effect, it is obviously not as great as to prevent the development of UGC, when one sees the tremendous development thereof. So, if there is a chilling effect, it probably only plays a role on a small part of projects; however, maybe those projects would have been very beneficial and interesting if they had materialized. As we illustrate elsewhere in this Study, if there may be a chilling effect to the present legal framework, there is at the same time an obvious “wait and see” approach from the rightholders, which some commentators, by opposition to the “chilling” effect, have referred to as the “warming up to UGC” effect<sup>1563</sup>, in addition to (or especially in light of) the growing phenomenon of monetization arrangements (see *infra*).

We have found the following testimonials and figures on this so-called chilling effect, but the veracity thereof is not always easy to verify:

- Two websites do exist, which lists examples of UGC works which have taken down after a notice of take-down sent to the platform by the rightholders while the UGC work was arguably not illegal, as well as reports and analysis of actions undertaken by different stakeholder arguably either in

---

reiterates a general principle. The general requirement is that a certain distance to the original must be kept, in the sense that the protected expression in the original work used in a derivative work has been used as inspiration only”.

<sup>1562</sup>For some “almost UGC sampling”, see: <http://thru-you.com/#/videos/3/>. Kutiman created some videos based upon YouTube videos of absolutely “amateur” (not in quality, though) musicians. Kutiman however is a professional DJ.

<sup>1563</sup>E. Lee, “Warming up to User-Generated Content”, available at [http://papers.ssrn.com/sol3/papers.cfm?abstract\\_id=1116671](http://papers.ssrn.com/sol3/papers.cfm?abstract_id=1116671)

favour or against free speech on the Internet: see [www.chillingeffects.org](http://www.chillingeffects.org) and [www.youtomb.com](http://www.youtomb.com). Although these kind of sites do not provide quantitative data over alleged “chilling effect”, they give interesting examples thereof.

- According to some commentators, many ISPs will quickly shut down an allegedly infringing website, even if the claim of the purported right holder is completely bogus<sup>1564</sup>. If only advised by rightholders as to what they should do, ISPs and platforms risk indeed practicing a pro-active self-censorship, thereby depriving users from any form of due process. Without analyzing this much further, let us mention that this issue is one of the issues mentioned in the reassessment of the e-commerce directive, with a public consultation being launched on how notice-and-take-down procedures are applied and should be improved, i.a. to guarantee more respect for the rules of due process and the right to be heard<sup>1565</sup> (see also infra on this issue).
- See also the other examples of chilling effects mentioned elsewhere in this Study.

One should observe however, that most if not all examples of chilling effects are to be found in the United States. Their judiciary system presents significant differences from most European judiciary systems, not the least regarding the costs of hiring a lawyer to defend one’s case but also the high risk of statutory damages which defendants to a copyright claim may be exposed to and which, more than other factors probably, do play a high role in chilling some projects. The US report mentioned above, apart from suggesting to add “incidental use” in the non-exhaustive preamble of Section 107 on Fair Use in the US also suggests reforming the system of statutory damages, which seems like a reasonable proposal (but on which we shall not insist here as it does not concern the EU Member States proceedings in court)<sup>1566</sup>.

Apart from the possible chilling effect of the legal framework, other legal and non-legal drivers and obstacles of UGC have been described in the literature such as<sup>1567</sup>:

- For **drivers**: technological drivers such as the availability across Europe of broadband internet access (specifically for the upload), of easy-to-use tools and of mobile broadband internet access<sup>1568</sup>; **economic** drivers such as affordable broadband pricing and a growing user engagement<sup>1569</sup>; **socio-cultural** drivers: self-expression and social interaction seem to be more important in UGC than making money; skills and media literacy are improving, particularly with the younger generations becoming major actors of UGC; **legal and policy drivers**: in the report of 2007/2008, the policy and legal settings were not considered as important drivers for the development of UGC<sup>1570</sup>, some interviewees arguing that policy makers might have contributed positively by refraining from a timely and strict enforcement of European directives and rules on copyright, privacy, data use and consumer protection: “*the absence of a clear stand of EUR*

1564 P.B. Hugenholtz, Codes of conduct and copyright enforcement in cyberspace, IVIR, Research Paper n° 2012-35, p. 317. The author mentions the real-life experiment called the “Liberty” experiment, <<http://pcmlp.socleg.ox.ac.uk/liberty.pdf>> and the ‘Multatuli project’ <[www.bof.nl/docs/researchpaperSANE.pdf](http://www.bof.nl/docs/researchpaperSANE.pdf)>.

1565 See the Commission’s document: Ensure the transparency, effectiveness, proportionality and fundamental rights compliance of notice-and-action procedures

(cf [http://ec.europa.eu/governance/impact/planned\\_ia/docs/2012\\_markt\\_007\\_notice\\_and\\_takedown\\_procedures\\_en.pdf](http://ec.europa.eu/governance/impact/planned_ia/docs/2012_markt_007_notice_and_takedown_procedures_en.pdf))

1566 J.M. Urban, Copyright Reform Act, prepared on behalf of Public Knowledge, Report 1, “Updating Fair Use for Innovators and Creators in the Digital Age: Two Targeted Reforms”, Berkeley Law, University of California, Samuelson Law, Technology & Public Policy Clinic, February 13, 2010, p. 27 et s.

1567 For a detailed description of these obstacles and drivers, see IVIR, TNO, IDATE, User-Created-Content : Supporting a participative Information Society, Final Report, Smart 2007/2008, p. 143 et s.

1568 IVIR, TNO, IDATE, User-Created-Content : Supporting a participative Information Society, Final Report, Smart 2007/2008, p. 147. This remark was made in 2007/2008 ; in the meantime, the situation has evolved in the right direction.

1569 Same remark as above.

1570 IVIR, TNO, IDATE, User-Created-Content : Supporting a participative Information Society, Final Report, Smart 2007/2008, p. 154.

*policy makers on these issues created the room for start-ups to experiment and grow quickly*<sup>1571</sup>... Again, these remarks date from 2007/2008; in the meantime, the landscape of UGC has evolved quite a lot;

- For **obstacles**: on **technological** obstacles, the report noted a lack of interoperability and standardization, a lack of broadband internet availability and of mobile broadband internet, low upload capacity of broadband internet and the lack of availability of equipment that can be used for producing UGC<sup>1572</sup>. Regarding **economic** obstacles, the report noted i.a. the high costs of fixed and mobile broadband internet, no viable revenue models, lack of original and high-quality content, lack of critical mass, difficulties to monitor the large amounts of content<sup>1573</sup>. The report also noted **social-cultural** obstacles (lack of skills and media literacy, digital divide, bad experiences of users vis-à-vis viruses, spams, hacking, lack of privacy, etc.); again, such findings dated from 2007/2008 and should be reassessed by an economic/market study.
- The **legal obstacles** which were identified then concerned i.a. copyright. The uncertainty of the applicable rules and the risk of legal proceedings which users cannot afford to defend against do apparently chill certain UGC projects<sup>1574</sup>; the report quoted the following interviewee: "*Copyright is not harmonized between countries and media types. UCC is all about collaboration across borders. When platform providers are not sure if content is legal or not, most of the time they chose to shut the content down*"<sup>1575</sup>. Lack of privacy, presence of harmful content, lack of security seemed then to also "chill" some projects. Divergences in national media policies were also mentioned as a potential legal obstacle in some cases<sup>1576</sup>.

As a final note on this "chilling effect", to the extent there is one (?), one may wonder if it comes from "copyright" *per se*, or rather from disuniformity. If the real problem is a lack of uniformity, that calls for a different solution (harmonization "*à droit constant*" – i.e. without substantially changing the existing rules) than if the problem primarily derives from inadaptability of substantive copyright rules – which would then require changes to these substantive rules.

## X. The solutions proposed by the stakeholders

The rightholders have not waited for the legal context of UGC to be clarified by the legislator in order to propose/test some solutions. They have, as is explained elsewhere in this Study, only very rarely resorted to courts to combat UGC, but they have tried to propose various solutions.

As has been interestingly described by a legal commentator<sup>1577</sup>, the rightholders began by (and to a certain extent continue to) adopting a "wait and see" approach vis-à-vis UGC. One must admit, when analyzing the present situation, that they have let it develop and grow without trying – or at least without aggressively trying – to combat it. Practices by users have developed in a gray area of copyright, in the absence of statutory provisions and of decisive case-law, and rightholders have first tacitly tolerated them

---

1571 Idem.

1572 IVIR, TNO, IDATE, User-Created-Content : Supporting a participative Information Society, Final Report, Smart 2007/2008, p.155. Again, these remarks date from 2007/2008; a new economic analysis should either confirm or infirm such findings.

1573 IVIR, TNO, IDATE, User-Created-Content : Supporting a participative Information Society, Final Report, Smart 2007/2008, p. 157. A new economic analysis should either confirm or infirm such findings.

1574 IVIR, TNO, IDATE, User-Created-Content : Supporting a participative Information Society, Final Report, Smart 2007/2008, p.165.

1575 IVIR, TNO, IDATE, User-Created-Content : Supporting a participative Information Society, Final Report, Smart 2007/2008, p. 165.

1576 Idem, p. 167.

1577 E. Lee, "Warming up to User-Generated Content", available at [http://papers.ssrn.com/sol3/papers.cfm?abstract\\_id=1116671](http://papers.ssrn.com/sol3/papers.cfm?abstract_id=1116671).

and then progressively accepted and eventually licensed such practices<sup>1578</sup>. This is all the more so that UGC “is often noncommercial – although this line is getting fuzzier with the growth of symbiotic relationships between commercial entities and individuals engaged in commercial pursuits”<sup>1579</sup>. Major copyright holders, such as Viacom, the Motion Picture Association of America (MPAA), CBS, NBC Universal or Warner Brothers Entertainment are reported to have expressed supportive views regarding mash-ups in UGC<sup>1580</sup>. A number of them have actively encouraged users to make mashup videos on their websites and sometimes even on third-party websites, hold contests for user-generated mashups<sup>1581</sup>.

Progressively, the rightholders have signed agreements with intermediaries such as video-sharing platforms.

Well-known examples include the “**Principles for User Generated Content Services**”, so-called “**UGC Principles**”<sup>1582</sup>:

Under these Principles (which take the form of a sort of memorandum of understanding), a list of signatories (being on one hand content owners and on the other “services providing user-uploaded and user-generated audio and video content, i.e. UGC platforms”<sup>1583</sup>) have ratified a number of principles. Copyright owners and UGC services “recognize that they share several important objectives: (1) the elimination of infringing content on UGC Services, (2) the encouragement of uploads of wholly original and authorized user-generated audio and video content, (3) the accommodation of fair use of copyrighted content on UGC Services, and (4) the protection of legitimate interests of user privacy”. To achieve those objectives:

- The signatories have put in place an identification technology for pre-identified copyright protected materials; “*Copyright Owners and UGC Services should cooperate to ensure that the Identification Technology is implemented in a manner that effectively balances legitimate interests in (1) blocking infringing user-uploaded content, (2) allowing wholly original and authorized uploads, and (3) accommodating fair use*”;
- A notice and take down procedure is put in place, relying on the identification technology, so that all contents which matches the reference materials of pre-identified content will automatically be blocked; “*UGC Services may, at their option, utilize manual (human) review of all user-uploaded audio and video content in lieu of, or in addition to, use of Identification Technology, if feasible and if such review is as effective as Identification Technology in achieving the goal of eliminating infringing content*”;
- “*Copyright Owners should provide Reference Material only with respect to content for which they believe in good faith that they have the appropriate rights to do so, and should update rights information as reasonable to keep it accurate*”;
- To avoid blocking by error, “*Copyright Owners and UGC Services should cooperate in developing reasonable procedures for promptly addressing conflicting claims with respect to Reference*

---

1578 Idem, p. 1461. The author describes in detail the “informal copyright practices” which developed in the field of UGC and have been tolerated by rightholders.

1579 Idem, p. 1503.

1580 Idem, p. 1516.

1581 Idem, p. 1518.

1582 A copy of these may be found at <http://www.ugcprinciples.com>. The process of arriving at this agreement is described in Alan N. Braverman and Terri Southwick, “The User-Generated Content Principles: The Motivation, Process, Results and Lessons Learned”, 32 Colum. J. L. & the Arts 471 (2009).

1583 The list of signatories include CBS Corporation, Dailymotion, Disney, Fox Entertainment Group, Microsoft, Myspace.com, NBC Universal, Sony Pictures, Viacom. It is however noteworthy that they have not (or not yet?) been ratified by YouTube nor by some major UGC players.

*Material and user claims that content that was blocked by the Filtering Process was not infringing or was blocked in error”;*

- Signatories should work together to identify sites that are clearly dedicated to, and predominantly used for, the dissemination of infringing content or the facilitation of such dissemination: *“Upon determination by a UGC Service that a site is so dedicated and used, the UGC Service should remove or block the links to such sites”;*
- *“When sending notices and making claims of infringement, Copyright Owners should accommodate fair use”<sup>1584</sup>;*
- A “notice-and-put-back procedure” is also put in place: *“When UGC Services remove content pursuant to a notice of infringement, the UGC Service should (a) do so expeditiously, (b) take reasonable steps to notify the person who uploaded the content, and (c) promptly after receipt of an effective counter-notification provide a copy of the counter-notification to the person who provided the original notice, and, at its option, replace the content if authorized by applicable law or agreement with the Copyright Owner”;*
- Some data retention principles are also included in the Principles;
- When confronted with repeated infringements by a same user, signatories have agreed a user-service termination policy: *“UGC Services should use reasonable efforts to track infringing uploads of copyrighted content by the same user and should use such information in the reasonable implementation of a repeat infringer termination policy. UGC Services should use reasonable efforts to prevent a terminated user from uploading audio and/or video content following termination, such as blocking re-use of verified email addresses”;*
- Outside of the United States, *“UGC Services and Copyright Owners should follow these Principles to the extent that doing so would not contravene the law of the applicable foreign jurisdiction”.*

The Principles have been criticized by some as not having been negotiated with representatives of users and as not giving enough place to the users. The **Electronic Frontier Foundation** (EFF) drafted an alternative proposal for the protection of fair use, which aims at safeguarding the fair use exception vis-à-vis the automatic filtering robots, via different mechanisms <sup>1585</sup>; to our knowledge, these EFF Principles have not been endorsed (yet?) by any major player or stakeholder in the UGC sphere.

Another well-known system comes from YouTube, which has not ratified these principles but instead developed its own policy for dealing with copyright infringement claims, called **Content ID** (formerly “Claim Your Content” policy); such policy illustrates the “monetization phenomenon” of UGC. It is an automated process by which rightholders can submit materials they wish to protect to YouTube, who then encodes it into a unique hash file, against which user-uploaded videos are compared. If the content to be uploaded matches, the rightholder can <sup>1586</sup> :

- Ask YouTube to reject it entirely;
- Allow it to stay up (perhaps for advertisement and public exposure purposes);
- Or alternately monetize it by placing ads next to it, with the rightholder sharing in the revenue with YouTube.

---

<sup>1584</sup> The manner by which such evaluation should take place is not further described.

<sup>1585</sup> See EFF, Fair Use Principle for User Generated Video Content, available at <https://www.eff.org/pages/fair-use-principles-user-generated-video-content>

<sup>1586</sup> For a description, see e.g. L. Edwards, “Role and responsibility of Internet intermediaries in the field of copyright and related rights”, Report for WIPO, available at :

[http://www.wipo.int/copyright/en/doc/role\\_and\\_responsibility\\_of\\_the\\_internet\\_intermediaries\\_final.pdf](http://www.wipo.int/copyright/en/doc/role_and_responsibility_of_the_internet_intermediaries_final.pdf)

The system combines conventional notice-and-take down with a degree of pre-emptive filtering, plus an option for revenue-sharing between platform and rightholder. YouTube is quoted as having said, in September 2011 (we could not find more recent figures) that, at that time, 15.000 “partners” (content owners, including major record labels and producers) had concluded monetization agreements with YouTube, that this had led to 3 billion YouTube visits being monetized, and that, as a result, small producers (hundreds of partners) are making more than 100.000 US dollars per year<sup>1587</sup>. Apparently, this solution is chosen in 90 % of copyright claims expressed by rightholders<sup>1588</sup>. All of the major labels in the music industry have struck partnership deals with YouTube<sup>1589</sup>, even if the response of the music industry vis-à-vis e.g. synchronization of music in user-generated videos was far less enthusiast (perhaps for moral rights concerns?)<sup>1590</sup>. **Creative Commons** established a sampling licence template. As noted by a commentator, it would be naive to think that rightholders had purely altruistic motives in allowing UGC: they see it as a channel to discover new talents, as a way to create buzz around their copyrighted works and, more important maybe, as a source of income via these monetizing agreements<sup>1591</sup>.

Apart from the UGC Principles and this system from YouTube, other systems exist. Audible Magic’s system **Copysense** for instance, yet this system offers comparison with millions of hashed copyright works but not monetization as an option and was initially designed to combat P2P file-sharing<sup>1592</sup>.

Audible Magic’s compliance and filtering solutions aim at eliminating risks of copyright infringement by using an automated copyright recognition (ACR) system. Copyright owners, such as music labels and movie and TV studios may register the content they want protected directly with Audible Magic. This content is included in their Global Rights Registry that contains (according to Audible Magic’s website) more than 12 million fingerprints, and represents over 900,000 hours of copyrighted songs, movies, television shows, and other video content<sup>1593</sup>.

These monetizing mechanisms do have their drawbacks:

- rightholders embracing systems like Content ID “allow the music hosting or streaming site a revenue stream from what might be seen as acquiescence in hosting or making available of infringing works”<sup>1594</sup>; this drawback has been highlighted by rightholders in the context of the Public Consultation by the Commission on the future of electronic commerce in the Internal Market and the implementation of the Directive on electronic commerce (2000/31/EC); the summary of the results of this Consultation indicates that rightholders complained about the trend

---

1587 Figures given by P.L. Andrade for Google at a workshop co-organized by WIPO and the Internet Society at the UN Internet Governance Forum (IGF), on 29 September 2011, in Nairobi, Kenya – see minutes of such workshop.

1588 The Official Google Blog, Making money on YouTube with Content ID, Aug. 27, 2008, available at <http://googleblog.blogspot.com/2008/08/making-money-on-youtube-with-content-id.html>; IDATE, TNO & IVIR, User-Created-Content: Supporting a participative Information Society, SMART, 2007/2008, p. 27 to 174. See also the OECD Report, OECD, DSTI/ICCP/IE (2006)7/Final, Working Party on the Information Economy, Participative Web: User Created Content, 12 April 2007, p. 102; Aaron Schwabach, February 2012, “User-generated Humorous Subtitles and Copyright”, available at [http://works.bepress.com/cgi/viewcontent.cgi?article=1003&context=aaron\\_schwabach](http://works.bepress.com/cgi/viewcontent.cgi?article=1003&context=aaron_schwabach), p. 22.

1589 E. Lee, “Warming up to User-Generated Content”, available at [http://papers.ssrn.com/sol3/papers.cfm?abstract\\_id=1116671](http://papers.ssrn.com/sol3/papers.cfm?abstract_id=1116671), p. 1519.

1590 Idem, p. 1519.

1591 Idem, p. 1522.

1592 For a list of partners (which includes Dailymotion, Myspace, Facebook), see:

<http://www.audiblemagic.com/customers-contentid.php>

1593 See for more information: <http://audiblemagic.com/solutions-maincompliance.php>

1594 L. Edwards, “Role and responsibility of Internet intermediaries in the field of copyright and related rights”, Report for WIPO, available at:

[http://www.wipo.int/copyright/en/doc/role\\_and\\_responsibility\\_of\\_the\\_internet\\_intermediaries\\_final.pdf](http://www.wipo.int/copyright/en/doc/role_and_responsibility_of_the_internet_intermediaries_final.pdf), p. 67.

towards the “monetization” of NTD (notice and take down) procedures, “which could be characterized as the development of a “notice-and-revenue-share” procedure”<sup>1595</sup>.

- for users, an issue may be whether such systems provide built-in systems to allow uploaders to benefit from copyright exceptions like fair dealing, parody or quotation<sup>1596</sup>. The difficulty is real, for how does one teach a robot to recognize a parody or a fair use<sup>1597</sup>?... Another concern is that the monetization mechanisms, based on notice-and-take down and filtering procedures, do not involve users sufficiently and do not allow them sufficient rights to object to a blocking. “*All filtering techniques involve a level of unintentional blocking of legal content (“overblocking”) and of unwitting admission of illegal content (“underblocking”)*”<sup>1598</sup>. In the Roadmap concerning the “Initiative on a clean and open Internet: procedures for notifying and acting on illegal content hosted by online intermediaries” (June 2012), DG MARKT indicated that it could take an initiative and, amongst the problems which the initiative might address, mentioned “*instances of conflicts [of NTD procedures] with fundamental rights such as the freedom of expression (...)*”<sup>1599</sup>. One of the main policy objectives of this initiative could be “*to ensure the transparency, effectiveness, proportionality and fundamental rights compliance of Notice & Action procedures*”. Such fundamental rights include in particular the freedom of speech and the right to fair process<sup>1600</sup>.

Another type of licence which must be mentioned, as they offer solutions for UGC are the **Creative Common (CC) Licences**, which, depending on the CC licence chosen, offers the possibility for users to adapt the work and redistribute it<sup>1601</sup>. This will typically be the case for<sup>1602</sup>:

---

1595 See the Summary of the results of the Public Consultation by the Commission on the future of electronic commerce in the Internal Market and the implementation of the Directive on electronic commerce (2000/31/EC), p. 12.

1596 L. Edwards, “Role and responsibility of Internet intermediaries in the field of copyright and related rights”, Report for WIPO, available at:

[http://www.wipo.int/copyright/en/doc/role\\_and\\_responsibility\\_of\\_the\\_internet\\_intermediaries\\_final.pdf](http://www.wipo.int/copyright/en/doc/role_and_responsibility_of_the_internet_intermediaries_final.pdf), p. 67. The author mentions a famous example, where a video on fair use and remix culture by Internet guru Lawrence Lessig was rejected by YouTube’s automated system, because it contained a short clip of background audio which had not been authorized by the rightholder. However, Content ID now provides for a counter-notice (or notice-and-put-back) procedure allowing an uploader whose video was rejected to ask for a manual reconsideration of the blocking. In this case, Lessig used it and his video presentation was put back by YouTube.

1597 For a possible answer, see Jane C. Ginsburg, “Separating the Sony Sheep from the Grokster Goats: Reckoning the Future Business Plans of Copyright-Dependent Technology Entrepreneurs”, 50 Ariz. L. Rev. 577 (2008): “Teaching” a filter to recognize a parody may not be an obvious proposition -- indeed the difficulties of teaching the fair use doctrine to human law students might make one less than sanguine about teaching a computer to recognize fair uses -- and “manual review” by copyright owners and/or internet services may be necessary. But one can imagine increasing levels of sophistication of filters, to recognize, for example, when the uploaded content matched by the “identification technology” to a copyrighted work consists entirely of the copyrighted content, or instead is composed of excerpts interwoven with truly user-generated content (or at least to content that does not match to the content which the filter identifies). For example, the byte equivalent of the apocryphal “250 word” threshold for permissible unauthorized quotations might be programmed into the filter; similarly, the filter might distinguish between overall quantity of content matched between the user-generated upload and a copyrighted work (or works), but might let pass matches that are not in sequence and therefore might more likely be parodies or remixes. The prospect of automated fair use might after all not prove as preposterous as first impression suggests; at least an automated process might isolate the universe of uploads requiring manual review by identifying postings that are clearly infringing (complete or near-correspondence to a work on the filter’s black list), and postings that are clearly non infringing (no correspondence, or a sub-threshold quantity or sequence correspondence to a work on the black list)”.

1598 Summary of the results of the Public Consultation by the Commission on the future of electronic commerce in the Internal Market and the implementation of the Directive on electronic commerce (2000/31/EC), p. 13.

1599 Roadmap, Initiative on a clean and open Internet: procedures for notifying and acting on illegal content hosted by online intermediaries” (June 2012), DG MARKT, p. 1.

1600 Idem, p. 2.

1601 It is worth to mention that YouTube offers CC licenses for uploaders.

1602 See <http://creativecommons.org/licenses>



- the Attribution (CC-BY) : it allows users to adapt the pre-existing work and communicate it to the public, provided only that the name of the initial author be mentioned.
- The Attribution Share-Alike licence (CC-BY-SA): users may adapt the work and redistribute it, provided that they mention the name of the initial author(s) and that they accept that the modified work is distributed under the same licence, i.e. that other users may also in turn adapt the work, etc. (with a so-called “copyleft effect” similar to the one which is familiar to some open source software).
- The Attribution Share-Alike Non Commercial (CC-BY-NC-SA): users may adapt the work and redistribute it, provided that they mention the name of the initial author(s), that they accept that the modified work is distributed under the same licence, i.e. that other users may also in turn adapt the work, etc. (with a so-called “copyleft effect” similar to the one which is familiar to some open source software), but with one additional limitation, being that the use by the users may not be commercial.

An important criterion of Creative Commons licence is the commercial or non-commercial further use of the work, since some licences are granted on the condition that no commercial use is made of the work (which may however – depending of the licence – be arranged, remixed, uploaded, etc.). The Creative Commons consortium has tried to define what “commercial” should be understood as meaning; the report is not entirely clear and the borderlines between commercial and non-commercial proved hard to draw.

On the other hand, the two licences CC ND (ND for “No Derivatives”) would not be of use for UGC as we understand it in our Study, since they do not allow users to modify the pre-existing work (which is a pre-condition for a UGC work as we defined it).

## **XI. Which other arguments do courts or commentators rely on to allow UGC?**

As explained, we could not identify case-law in Europe authorizing (or prohibiting) UGC as such. Commentators are prolific about the importance of UGC, UGC itself is developing at great speed; a big part of it is either “created from scratch” or “mere uploading of pre-existing content”. Yet there appears to be no case-law yet, whereby a court would have either authorized a use by e.g. allowing an extensive interpretation of an existing exception, or issued an injunction against a user by applying strictly the copyright principles.

However, it is logical to raise the question, as it is put in the Terms of Reference of this Study, as to whether other arguments than those based on copyright were relied or could be relied upon to allow UGC (if counsel to plaintiffs or defendants use their creativity and imagination). One indeed may observe as a general trend in copyright law (which we had already described in 1997)<sup>1603</sup> that courts have, mostly since the development of digital technologies, had more than in the past, recourse to arguments outside of copyright in copyright disputes. Competition law may have been one of the first ones, but other arguments have flourished over the years, from consumer law, to privacy, to contract law (and unfair terms legislation), etc.

Before describing what those arguments found outside of copyright could be, one may raise the following question: does it make a difference whether the argument is found outside of copyright or by relying on an exception explicitly provided for by copyright legislation? The answer is not an easy one. While it is clear that any reasoning based on the “internal exceptions” of copyright must respect the three-step test, it is in

---

<sup>1603</sup> On this development of copyright law, see i.a. A. Strowel & J.P. Triaille, *Le droit d’auteur, du logiciel au multimedia, droit belge, droit européen, droit comparé*, Kluwer/Bruylant, Brussels, 1996, p. 303, p. 470.

our view not so clear that this is also the case when an argument is found outside of copyright, yet authoritative commentators do not share our doubts<sup>1604</sup>.

The following arguments/legal grounds could be or have been put forward by commentators to support the need of a UGC exception or to allow a reasoning which would lead to tolerating UGC in cases where it should, upon a strict application of copyright dogma's, have succumbed to an injunction proceeding:

### A. Freedom of expression<sup>1605</sup>

The idea is that the Web 2.0 is characterized by a wider access by all to all kinds of information and by the possibility for all to express their opinions and made them known to the rest of the world.

More generally, conflicts between the copyright and the freedom of expression are not new. They are partly solved by existing principles of copyright such as: the non-protection of ideas, principles, mere facts or data, the originality requirement (leaving out some types of works outside of copyright), the "substantial part" infringement analysis in common law jurisdictions such as the UK<sup>1606</sup>, the right of quotation, the right to make caricatures and the exception in case of incidental inclusion. But in the last years, conflicts between copyright principles and the freedom of expression principle seems to have multiplied<sup>1607</sup>. Apart from the *Germania 3* decision (commented further) by the German Supreme Court, one should mention the *Church of Scientology v. Dataweb* case by the Court of appeal of The Hague<sup>1608</sup>, opposing the Church of Scientology and a former member who had disclosed long extracts of texts by Ron Hubbard; the Court of appeal recognizes the existence of a copyright infringement but, after a long reasoning (partly inspired from a US style "fair use" examination), considered that "in certain exceptional cases" copyright has to give way to the principle of freedom of expression. The factual circumstances played an important role, i.a. the secret practices of the Church of Scientology which the court considered as running against democratic values.

Needless to say that only a very small portion of UGC materials could benefit from such a favourable and "exceptional" treatment.

1604 In the decisions which will be mentioned hereafter, it is noticeable (and logic, in our view) that none (to our knowledge at least) worried about the compatibility of their reasoning with the three-step test. This important question may not be examined in detail in this report. According to (a discussion with) Jane Ginsburg, the author of this report must clarify that Professor Ginsburg does not share his doubts and considers that for purposes of implementing Berne/TRIPs/WCT/WPPT minimum rights, the treaties are agnostic about how the rights are labelled, including whether the rights are formally "copyright" or the same result is achieved under some other label. In her view, what counts is whether the level of protection is achieved and it is this approach which enabled the US to claim that it was in conformity with art. 6bis, because, though the US have almost no moral rights in the Copyright Act, they claimed to have equivalent protection through other sources of law, including trademarks, defamation and tort law. In Professor Ginsburg's opinion, one might argue that limitations on the scope of copyright rights follow the same logic: it does not matter whether the limitation is "internal" to copyright or external, the question is what effect it achieves. If it reduces the scope of protection, then the reduction should be consistent with the three-step test. Her view is shared by Sam Ricketson, and also by Michael Ficsor (see <http://www.copyrightseesaw.net/data/documents/documents/0/e/b/0eb32b716fcaa400dd4cf398256e3fa8.doc>)

1605 On this topic, see A. Strowel & F. Tulkens (eds), *Droit d'auteur et liberté d'expression, Regards francophones, d'Europe et d'ailleurs*, Larcier, Brussels, 2006 ; A. Strowel & F. Tulkens, « Freedom of expression and copyright under civil law : of balance, adaptation and access », in J. Griffiths & U. Suthersanen (eds), *Copyright and Free Speech, Comparative and international analyses*, Oxford University Press, 2005, p. 296 et s.; P.B. Hugenholtz, "Copyright and freedom of expression in Europe", in N. Elkin-Koren & N.W. Netanel (eds), *The Commodification of Information*, 2002, p. 239 et s.

1606 Yet the fate of such argument is uncertain in the aftermath of the *Infopaq* decision of the EUCJ.

1607 See the numerous decisions commented in A. Strowel & F. Tulkens (eds), *Droit d'auteur et liberté d'expression, Regards francophones, d'Europe et d'ailleurs*, Larcier, Brussels, 2006, which would deserve more consideration, if this would not lead us outside the limits of this report.

1608 *Gerechthof's Gravenhage*, 4 september 2003, *Computerrecht*, 2003/6, p. 357; *Auteurs & Media*, 2004/1, p.44 (with a note by A. Strowel & G. Gathem). The Church of Scientology appealed before the Dutch Supreme Court but thereafter resigned from its legal action.

In the U.S., a landmark case is the Supreme Court decision in *Eldred v. Ashcroft*<sup>1609</sup>, where copyright and First Amendment (freedom of speech) principles were debated. In the opinion of the Court delivered by Justice Ginsburg, one may read that “*the First Amendment securely protects the freedom to make—or decline to make—one’s own speech; it bears less heavily when speakers assert the right to make other people’s speeches. To the extent such assertions raise First Amendment concerns, copyright’s built-in free speech safeguards are generally adequate to address them*”. Justice Ginsburg adds in her opinion: “*We recognize that the D. C. Circuit spoke too broadly when it declared copyrights “categorically immune from challenges under the First Amendment.” (...) But when, as in this case, Congress has not altered the traditional contours of copyright protection, further First Amendment scrutiny is unnecessary*”. This illustrates that copyright may, in certain situations (yet not in the *Eldred v. Ashcroft* case), be limited by considerations deriving from the freedom of expression principle; since the Court accepts that copyright is not “categorically immune” from claims based on freedom of expression.

One shall recognize in any case that cases giving priority to the principle of freedom of expression over copyright remain limited in number and to exceptional circumstances<sup>1610</sup>.

Partly along with the freedom of information, the freedom of the press has been mentioned by some commentators to justify a UGC exception<sup>1611</sup>. This suggests that users acting outside of their professional activities be considered as journalists and may invoke the protection (which may vary from one State to another) granted to journalists or the press.

Some have expressed their opposition against this view (that copyright should give way to freedom of expression in the following terms: “*The mere reason that a derivative work is created and made available and that therefore it should be free in order to guarantee the freedom of expression is hardly an acceptable reason alone since Article 12 and 14 (1) of the Berne Convention provide for an exclusive right of adaptation which ‘by definition’ covers the creation of derivative works. It would create a clear conflict with the Berne Convention (the TRIPS Agreement and the WCT) if a national law provided for free adaptation or other free alteration of a work consisting in the creation of a new –derivative- work on the basis of the consideration that allowing free creation of derivative works is justified for guaranteeing freedom of expression*”<sup>1612</sup>. M. Ficsor adds that the mere absence of a commercial purpose does not in itself suffice for such UGC exception to become acceptable under the international treaties and the three-steps-test and considers that such exception would run contrary to the right of reproduction, the right of adaptation and the right of making available. One can certainly agree to this view to the extent that the idea could not be that freedom of expression in itself should in all circumstances prevail over the application of copyright (and by the way we found no authoritative commentator arguing so far).

In June 2012, the ICC issued a Policy Statement on “the Freedom of expression and the free flow of information on the Internet”, wherein one could read the following:

*“Business strongly supports the freedom of expression and free flow of information in a manner that respects the rights of others and the rule of law. (...) ICC recognises the principle that all the rights that people have offline, including but not limited to the freedom of expression, must also be equally protected online. Limitations to those rights that protect the rights of others and the rule of law that exist offline do also exist online. For example, limitations to address and deter illegal content such as child pornography or theft of intellectual property are legitimate in accordance with Article 29 of the UN Universal Declaration of Human Rights, and wholly appropriate.”*

---

1609 *ELDRED V. ASHCROFT* (01-618) 537 U.S. 186 (2003) 239 F.3d 372, affirmed.

1610 S. Dusollier, “The relations between copyright law and consumers’ rights from a European perspective”, for the European Parliament, DG for Internal policies, November 2010, p. 13.

1611 E. Lee, “Warning up to User-Generated Content”, available at [http://papers.ssrn.com/sol3/papers.cfm?abstract\\_id=1116671](http://papers.ssrn.com/sol3/papers.cfm?abstract_id=1116671), p. 1505.

1612 Ficsor, p. 15.

On the balance between freedom of expression and copyright, it may be worth recalling a general (and undisputed) principle of copyright, which provides that copyright only protects expressions but not ideas (which remain free to circulate)<sup>1613</sup>.

## B. The freedom of trade and of competition

Even if such position has not been taken over explicitly in many court decisions, it may be worth mentioning that some commentators insist on the idea that the governing principle of our market economies is (in Europe, probably mainly since the end of the 18<sup>th</sup> century and the abolition of privileges by the French Revolution) the principle of freedom of trade and of competition and that, in such context, intellectual property rights regimes are as many monopolies, which, because they constitute monopolies, should be interpreted restrictively. The consequences thereof is that the main principle should remain the “freedom to copy” others and, for exceptions to copyright, that exceptions to copyright should not necessarily be interpreted restrictively since they are “exceptions to an exception”.

The freedom “to conduct a business”, enshrined in the article 16 of the Charter of Fundamental Rights of the European Union, was also taken into account by the EUCJ in a slightly different context, concerning the measures that can be imposed to a private company (namely, an Internet Services Provider) in order to prevent copyright infringements. In *Scarlet*<sup>1614</sup> and *Netlog*<sup>1615</sup>, the Court emphasized the need to strike a fair balance between the protection of Intellectual Property rights and the freedom to conduct a business. Consequently, an injunction made to an ISP “to install a complicated, costly, permanent computer system at its own expense” to ensure the respect of intellectual-property rights was found a serious infringement to its right to conduct a business and contrary to the above-mentioned balance of interests.

## C. The balance of interests

Whereas courts in *droit d'auteur* countries have usually considered exclusive rights as property rights proper and exceptions as having to be interpreted narrowly (and have recently been comforted in this by the CJUE in its *Infopaq* decision), the US copyright system is often described as having a more utilitarian function (with the US Constitution describing its role as “to promote the progress of science and useful arts”). Such utilitarian function is reflected in the US fair use exception, which does introduce flexibility in the exceptions but at the same time increases the unpredictability of the outcome of copyright lawsuits. The idea that copyright should be based on a balance (to be made by courts) between the interests of authors, of users and of society as a whole has gained in importance and weight, including in *droit d'auteur* countries<sup>1616</sup>. The recent proposal by the Wittem Project of a European Copyright Code also embraces this idea in its preamble<sup>1617</sup>.

The dichotomy between *droit d'auteur* and copyright traditions on this should however not be overestimated. On the protection of architectural works, for instance, the French Supreme Court

---

1613 As stated by Desbois, « les idées sont de libre parcours » : « ideas are free as the air » (our translation). In US law, the « idea/expression » dichotomy is a well-know concept to explain that ideas may be reused and that a copyright issue would only arise where not only ideas but part of the expression of a previous work was also reused

1614 EUCJ, 24 November 2011, C-70/10, *Sabam v. Scarlet*

1615 EUCJ, 16 February 2012, C-360/10, *Sabam v. Netlog*

1616 See for instance the Dutch Supreme Court Decision in the *Dior v. Evora* case, 20 october 1995, *Nederlandse Jurisprudentie*, 682, as commented by B. Hugenholtz & Dr. M.R.F. Sentfleben, *Fair Use in Europe*. In *Search of Flexibilities*, Amsterdam, November 2011 (available via [www.ssrn.com](http://www.ssrn.com)), p. 10.

1617 See *European Copyright Code*, by the Wittem Project, p. 11.

mentioned the need to find a balance between the interests of the proprietor (and user) of the building and the rights of the architect (author) and applied a sort of proportionality test<sup>1618</sup>.

An interesting case in this respect is the *Germania 3* decision by the German Supreme Court : in that decision, the Court said, about quotations made in a play and which were not respecting the limits put by copyright law, that the quotation right has to be interpreted broadly, in the light of the freedom of artistic expression embedded in Article 5.3. of the German Constitution and that copyright exemptions should reflect a balancing of relevant interests<sup>1619</sup>.

In Austria, the Supreme Court also held in a decision of 12 June 2001 that copyright could not be invoked against the freedom of expression of a person who was considering that she was the victim of a press campaign, and in a decision of 20 May 2001, that a report in a newspaper about the contents of a political report in another newspaper could not be prohibited on the basis of copyright<sup>1620</sup>.

However, one must admit that such decisions, like the ones referring to the freedom of expression, are taken in very specific circumstances and that, even in cases of balances of interests, countries like Germany, the Netherlands or Austria where the Supreme Courts have sometimes given priority to the principle of freedom of expression over copyright, there are decisions from the same Supreme Courts going in the opposite directions<sup>1621</sup>. It is therefore very delicate on such an issue to give an exhaustive and non-ideological view.

As a reminder, we could not find decisive case-law on UGC where these issues would have been debated and where courts would have given clear, let alone consistent, guidelines about how to make such balance of interests between the interests of rightholders, of users and of society as a whole.

#### D. The *ratio legis* of the exception

When looking at arguments within copyright, in *droit d'auteur* countries, authoritative commentators are often rather reluctant to embrace the idea that judges should be allowed some flexibility in interpreting exceptions or in having recourse to arguments outside of copyright. A. Lucas however interestingly suggested the following: "*Does this mean that the judge loses any power of appreciation ? Obviously not. First of all, it is his duty to implement the exceptions in accordance with their spirit, by granting them their full scope, without systematically tipping the balance in favour of the rightholder, under the pretext of a principle of strict interpretation (...). One could even, without however generalizing the reasoning by analogy, as the Dutch Supreme Court has done (in Dior v. Evora), admit that the judge rely on the ratio legis to adapt a legal exception to a new technical environment, as the German Supreme Court has (carefully) done*"<sup>1622</sup>,<sup>1623</sup>.

---

1618 A. Lucas, « Actualités du droit d'auteur en France (2007/2011) », *Auteurs & Media*, 2012, 1, p. 37.

1619 German Supreme Court, *Germania 3 Gespentster am toten Mann*, 29 June 2000, *Zeitschrift für Urheber- und Medienrecht (ZUM)*, 2000, p. 867.

1620 OGH, 12 June 2001, *Medienprofessor*, *GRUR int.* 2002, p. 341 ; and OGH, 20 May 2003, *Medien und Recht*, 2003, p. 387. Both decisions are cited by Prof. A. Lucas as illustrating cases where copyright had to give way to the principle of freedom of expression; see A. Lucas, "Droit d'auteur, liberté d'expression et 'droit du public à l'information' (libres propos sur deux arrêts des Cours de cassation belge et française)" in A. Strowel & F. Tulkens (eds), *Droit d'auteur et liberté d'expression, Regards francophones, d'Europe et d'ailleurs*, Larcier, Brussels, 2006, p. 127.

1621 See the court decisions mentioned by A. Lucas, "Droit d'auteur, liberté d'expression et 'droit du public à l'information' (libres propos sur deux arrêts des Cours de cassation belge et française)" in A. Strowel & F. Tulkens (eds), *Droit d'auteur et liberté d'expression, Regards francophones, d'Europe et d'ailleurs*, Larcier, Brussels, 2006, p. 128.

1622 In its decision of 11 July 2002, *Elektronische Pressespiegel*, *GRUR Int.*, 2002, p. 963.

1623 A. Lucas, "Droit d'auteur, liberté d'expression et 'droit du public à l'information' (libres propos sur deux arrêts des Cours de cassation belge et française)" in A. Strowel & F. Tulkens (eds), *Droit d'auteur et liberté d'expression, Regards francophones, d'Europe et d'ailleurs*, Larcier, Brussels, 2006, p. 138 and 139 (our translation).

This opinion is all the more interesting in view of the recent jurisprudence of the CJUE, which indeed seems to consider that Member States, when implementing one of the exceptions of the closed list of the InfoSoc Directive, must do so while duly taking into account the purpose of the exception.

This argument, even though not yet tested in court, could provide for interesting arguments in assessing whether a UGC material can pass muster and prosper without have to undergo injunction orders.

### E. Misuse of copyright

The theory of misuse of copyright (in common law countries) or of abuse of copyright (in civil law countries) may also be thought of as an argument to which a court could have regard in a UGC case opposing a rightholder and a user. Such theories “*may on occasion offer users of copyright works a measure of comfort, [but] these doctrines remain controversial in theory and are rarely applied by the courts in practice*”<sup>1624</sup>. According to this theory, a right may not be used (invoked) in an abusive manner, e.g. in a manner which is contrary to the legislator’s intention when the legislator created this right. Copyright should not be allowed to be used in a manner which is contrary to its purpose, “*in particular if it is being invoked to prevent the freedom of expression or the free circulation of opinions*”<sup>1625</sup>. According to A. Lucas, this theory is to be preferred to the recourse to arguments which are external to copyright, such as to fundamental rights the contours of which are often uncertain.<sup>1626</sup>

In Spain, the Supreme Court took a decision going in this direction, in its ruling on the „Google cache“ case (or also known as „Megakini“)<sup>1627</sup>, dealing with the functioning of the Google search engine and its cache service. After accepting that none of the statutory limitations listed in the Spanish Copyright statute (TRLPI) exempted the unauthorized use of fragments of the contents of a personal website through the Google search engine and *cache copy* service, the Supreme Court concludes against infringement, based on the grounds that the three-step-test (in art.40bis TRLPI) is to be read not only in a negative manner but also in a positive sense so as to take into account that intellectual property –as any other kind of property– is limited in nature and must endure any *ius usus innocui* (harmless uses done by third parties) and must abide to the general principles of the law, such as good faith and prohibition of an abusive exercise of rights (ex art.7 Spanish Civil Code).

Again, let us mention that such argument can be thought of in relation to UGC (against “abusive” recourse to copyright by rightholders to obtain a “takedown” of a UGC work from a website or platform) but has not actually been tested in any case court, to our knowledge.

### F. Implied consent

A decision by the German Supreme Court in the Google thumbnails case is another example where a court tried to find arguments (and flexibility) outside of copyright and, in that case, decided in favour of Google that, despite the fact that the right of quotation did not allow it, Google’s use of thumbnails “was not unlawful because the copyright owner had consented implicitly to the use of her material in the image

---

1624 B. Hugenholtz & Dr. M.R.F. Sentfleben, Fair Use in Europe. In Search of Flexibilities, Amsterdam, November 2011 (available via [www.ssrn.com](http://www.ssrn.com)), p. 12; C. Caron, “Abuse of Rights and Author’s Rights”, 176, RIDA, 2, 4 (1998).

1625 A. Lucas, “Droit d’auteur, liberté d’expression et ‘droit du public à l’information’ (libres propos sur deux arrêts des Cours de cassation belge et française)” in A. Strowel & F. Tulkens (eds), Droit d’auteur et liberté d’expression, Regards francophones, d’Europe et d’ailleurs, Larcier, Brussels, 2006, p. 140.

1626 Idem, p. 141.

1627 STS 172/2012, 03.04.2014; for a comment, see Raquel Xalabarder, “Spanish Supreme Court rules in favour of Google search engine... and a flexible reading of copyright statutes? ”, 3 (2012) JIPITEC, available at <http://www.jipitec.eu/issues/jipitec-3-2-2012/3445>

search service by making her works available online without employing technical means to block the automatic indexing and displaying of online content by search engines<sup>1628</sup>.

A quite similar decision may also be found in France, with the decision by the Paris Court of Appeal in the Google thumbnails case dd. 26 January 2011<sup>1629</sup>. In this decision judges took also into account the fact that no means had been used to prevent the automatic indexing.

## XII. Preliminary conclusions

As asked by the Commission, we have not discussed, in this first part of our Study on UGC, the possible solutions which the Commission could think of, should it conclude there is a problem and that it requires introducing some kind of “UGC-friendly” provision into copyright.

We will do this in a second part of our Study.

But this does not prevent us from drawing some preliminary conclusions at the end of this first part of our Study. UGC has grown exponentially in the last few years. A major part of UGC which may be found on the internet requires in principle a prior licence from the rightholders (whether it be for the reproduction right, the adaptation right or the right of making available). The exceptions which exist presently in copyright law and can be relevant (parody, quotation, incidental use) could only be invoked for a relatively small number of UGC materials; and the legal arguments which could be found outside of copyright would provide relief in an even smaller number of UGC cases. Some said that the European legal framework “leaves a lot of uncertainties for the parties concerned”<sup>1630</sup>; on the other hand, when analyzing concrete UGC cases and wondering whether there is a potential copyright infringement, there are, in our opinion, much more instances where the answer may clearly be “yes” than cases where the answer will be “no” or will be uncertain.

Yet, there is **very little (if any) case-law** and apparently **not much opposition** from rightholders.

It proved, as we have seen, very hard to find cases, as the Commission had asked us to investigate, where UGC should have been accepted by courts while it has not been, or even cases where UGC cases were rightfully rejected.

The obvious lack of opposition (at least via court proceedings) by rightholders may have various reasons: they may consider that such use does not cause them any noticeable harm (at least, not of such importance to justify court proceedings), or that it increases their reputation and public exposure. Also, the lack of opposition may be explained by the fact that, in many cases, a monetization agreement has been concluded between the rightholder and the platform. It seems that rightholders adopt a sort of “wait & see” approach or generally do not mind the UGC uses. The difference of attitude of rightholders vis-à-vis UGC and vis-à-vis peer-to-peer is obvious. But this general tolerance by rightholders might be temporary (no-one can predict whether the “wait and see” approach will continue to prevail or whether the monetization solutions will continue to prove attractive); also, it does not protect users against a possible more aggressive attitude by a more pro-active rightholder (for whatever reason).

In the second part of our Study, we will assess which initiative the Commission could take and whether any initiative is needed at all from the Commission in the field of UGC.

---

1628 BGH, 29 April 2010, case I ZR 69/08, p. 14-15 (the quotation is here from B. Hugenholtz & Dr. M.R.F. Sentfleben, Fair Use in Europe. In Search of Flexibilities, Amsterdam, November 2011 (available via [www.ssm.com](http://www.ssm.com)), p. 12 and p. 16.

1629 On this decision, see notably A. Lucas, obs., Prop. Intell., avr. 2011, p. 201-203.

1630 IDATE, TNO & IVIR, User-Created-Content: Supporting a participative Information Society, SMART, 2007/2008, p. 27 to 174. See also the OECD Report, OECD, DSTI/ICCP/IE (2006)7/Final, Working Party on the Information Economy, Participative Web: User Created Content, 12 April 2007, p. 183.

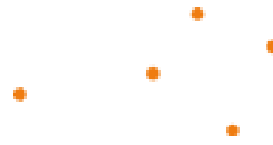

## User Generated Content (UGC) – Second Part

### Description of possible initiatives which could be taken by the European Commission

By **Jean-Paul TRIAILLE**, Partner, De Wolf & Partners ([www.dewolf-law.com](http://www.dewolf-law.com)) and Lecturer (IT Contracts) at the University of Namur,

with the assistance of **François COPPENS**, attorney-at-law and researcher <sup>1631</sup>

The author wishes to thank Professor Jane Ginsburg (Columbia University, NY) for her input and the following national experts for their input on the situation in their country : for Denmark, Thomas Riis, Professor at University of Copenhagen, Faculty of Law; for France, Stéphanie Carré, Maître de Conférences, CEIPI, Université de Strasbourg; for Germany, Sylvie Nérisson, Max Planck Institute for Intellectual Property and Competition Law, Munich; for Hungary, Peter Mezei, Assistant Professor at University of Szeged; for Italy, Giuseppe Mazziotti, Center for European Policy Studies (CEPS), Brussels; for Poland, dr. Maciej Barczewski, attorney-at-law, and Head of Postgraduate Program in Intellectual Property and High Technology Law, University of Gdansk; for Spain, Raquel Xalabarder Plantada, Vicerectorat d'Ordenació Acadèmica i Professorat Directora Adjunta, Universitat Oberta de Catalunya; for the United Kingdom, Estelle Derclaye, Professor of Intellectual Property Law, Faculty of Social Sciences, University of Nottingham.

The responsibility for this Study and for the opinions expressed herein remains with its author(s).

---

<sup>1631</sup> The authors wish to thank Séverine DUSOLLIER and her team (CRIDS, University of Namur), Alain Strowel (Université Saint-Louis, Brussels), Jane GINSBURG (Columbia University, NY), and other colleagues at the University of Namur or associates at the firm for the time they accepted to take to discuss UGC related issues with us. Obviously, the liability of the report and of its conclusions remains that of the authors only and the views expressed do not represent the views of the Commission.





## Introduction

This report is the second part of a report on User-Generated-Content (“**UGC**”). The first part has been included in this report, just before this second part.

The **first part** concentrated on a description of the issues at stake, of the existing case-law, on the impact of UGC on exclusive rights, on the applicability of existing exceptions and on legal arguments which could be relevant, outside (or, sometimes, inside) of copyright in relation to UGC.

In this **second part**, we will list the various possibilities which the Commission could consider, if the need to act in this area is established.

As already indicated in the first part of the report, apart from the analysis which we did through these two parts of the report, we think it would be useful that the Commission obtains the results of an economic/market analysis: through our “legal lenses” indeed, we could identify a number of issues, little case law and (in this second part) a number of initiatives which are theoretically possible. But we could not identify, at least in any exhaustive or objective manner, a significant “chilling effect” of the existing legal framework on UGC projects, or the possible consequences of such an effect which, due to this (existing or not) chilling effect, possibly never materialised. Neither were we able to assess the effects that a change in the existing legal framework would have on issues such as the current licensing arrangements between rights holders and platforms (except of course that if, for instance, a UGC exception was adopted, some of the existing licensing schemes would become unnecessary). This “hidden part of the iceberg”, if it exists, could only be examined via an economic/market analysis and via interviews<sup>1632</sup>; this was not part of our mission.

## Terms of reference

For the sake of clarity, it is important that the main elements of the terms of reference (the “**Terms of Reference**”) of our report be explained from the beginning.

This report takes place in an assessment exercise which the European Commission (“**the Commission**”) asked our firm to do in 2013, on the basis of article 12 of the Directive 2001/29/EC of the European

---

<sup>1632</sup> We did mention in the first part of the report other economic studies or market studies which were made by others, but they either date back to quite some time ago, or dealt with UGC in a more general sense, including all forms of UGC (which is not what our report is about – see hereafter for the notion of UGC which we will rely upon).

See First Part of our report, pages 8 and 9, where we define what this report understands as “UGC”:

*“We need to be clear, at the outset of this report, that what we will consider as UGC (and what we will deal with in our report) are cases where a pre-existing work is taken by a user as a starting point for his/her own expression. It means that we limit the examination to the situations where there is a pre-existing work and where such work will be modified in one way or another to then be made available online.*

*As a consequence, we exclude from our report the two following scenario:*

*What we will call “**the creation from scratch case**”, i.e. the case where a user creates a new work “from scratch”, without relying on a pre-existing work. (...)*

*What we will call the “**mere upload case**”, i.e. the case where a user merely distributes on the internet (by uploading it) pre-existing works without having intervened in any way on the work; some called this “User-Copied Content”.*

*So, what will interests us are situations where a “user” (therefrom the expression “User-Generated-Content”) relies on a pre-existing work, “arranges” it, and then uploads it on a website or web platform of some kind.”*

Parliament and of the Council of 22 May 2001 on the harmonisation of certain aspects of copyright and related rights in the information society (“**the InfoSoc Directive**” or “**the Directive**”).

At the request of the Commission, we divided our analysis in two parts:

- first, a description of the “**as is**” situation (what rules apply to UGC ? are they adequate? is there case-law on UGC? how do commentators analyse the UGC phenomenon?) – this has been the subject-matter of this first report;
- in this second part, we will now deal with the “**could be**” situation and analyse the need (or not) (from the point of view of providing a predictable legal framework) or not for the Commission to intervene on UGC and, if a need exists, how best the Commission could intervene. We will list a number of possible options, ranging from “suggesting a specific UGC exception”, to... doing nothing.

The general purpose of the Study commissioned to our firm (which materialises in a series of separate reports, this one on UGC being only one of them) is “*to assess the extent to which the implementation of the Directive is appropriate to the economic and technological realities of digital markets and evaluate whether and, if so, to what extent, further harmonisation in some areas of copyright is needed in order to enable the EU to capitalize on the opportunities of a digital single market*”. As Internet and digital technology are rapidly changing the way in which works and other protected subject matter are produced, distributed and used, many of these changes could not be reflected nor sometimes even envisaged in the report that was undertaken in 2006<sup>1633</sup>.

The Commission was of the opinion that some key limitations and exceptions needed to be reassessed but considered, in line with previous Commission documents which we listed in our first report, that UGC also deserved consideration in the reassessment exercise of the Directive. The Commission therefore did not want to limit the exercise to examining exceptions which were already provided for by the Directive but wanted to also examine the need for possible new exceptions, such as one which would deal with UGC.

## I. Subject matter

As noted by the Terms of Reference (p. 5), “*the fast development of social networking and social media sites which rely on the creation and upload/distribution of online content by end-users raises a certain number of questions in terms of copyright. These new applications enable users to generate new content and new practices for media and artistic expressions have emerged*”.

As noted in the first part of our report, while some stakeholders argue in favour of a new exception to cover such UGC, others argue for increased flexibility and clarity of the already existing exceptions of the closed list of the Directive, together with the application of the 3-step test (Directive, art. 5(5)), not only to facilitate UGC but also to facilitate the emergence of new business models for commercial users. Others take the view that licensing schemes should be the preferred option and insist that such schemes are increasingly available, and point to the legal certainty provided by existing arrangements covering use and re-use on major platforms<sup>1634</sup>. Concerns as to consequences of a UGC exception not only on licencing practices but also in terms of the normal exploitation of copyright protected content are also

---

<sup>1633</sup> Report by the Institute for Information Law (IVIR), Study on the implementation and effect in Member States’ laws of Directive 2001/29/EC on the harmonization of certain aspects of copyright and related rights in the information society, Parts I & II, February 2007.

<sup>1634</sup> See however, *infra*, in this report: the existing arrangements and available licensing schemes more often deal with “mere upload” cases, but not with cases where the user adapts or in some way changes a pre-existing work, and often do not deal with cases where the user could invoke the existence of a quotation exception or of a parody exception.

often raised, the argument being made that the only beneficiaries of an exception would be the commercial operators running the platforms used to upload and communicate UGC.

In the **first part of our report**, after describing what we understand by UGC in the report, we presented some available figures and gave a brief summary of the EU Commission's position on UGC (as reflected in various Commission documents and communications). We then described the extent to which the exclusive rights (both economic rights and moral rights) of copyright were concerned/affected by UGC. We then analysed the exceptions from the Directive which were relevant for UGC, i.e. the quotation exception, the exception relating to use for the purpose of caricature, parody or pastiche and the incidental inclusion exception and described the way in which these exceptions had been (or not) implemented in the Member States. We then mentioned the recent case-law of the EUCJ which could be relevant for our report and a few (rare) decisions which dealt explicitly with UGC cases. We tried to see if a so-called "chilling effect" of the copyright law on UGC could be evidenced and we described some of the licensing mechanisms which stakeholders have put in place to license/authorize UGC uses. Finally, we described the arguments outside of copyright which judges or commentators sometimes invoke to authorize UGC in cases where copyright might not grant such freedom of use, before drawing preliminary conclusions. As mentioned in the first part of our report, we do not consider here other legislation than copyright, even if some may have an importance on UGC (like defamation law, consumer law, liability issues, etc.).

As invited by the Terms of Reference, we will also examine (in the second part of our report) whether legal arguments inspired from a kind of "fair use" exception in the US-style could be a solution to allow some UGC uses which could not be justified on the basis of the InfoSoc Directive but which one might reasonably expect should be allowed.

We concentrate our analysis on non-commercial UGC, yet recognizing (as explained in the first part of our report) that it may be hard to draw a line between commercial and non-commercial UGC. This being said, the commercial/non-commercial character of an act is in most copyright cases of little relevance<sup>1635</sup>, by opposition to the public v. private character of a use.

To describe it very briefly, the purpose and subject matter of our report is to examine from the point of view of the adequacy (certainty, clarity, predictability) of the legal framework the need (yes or no?) of a new UGC exception which would be added to the closed list of the InfoSoc Directive, whether it may prove more appropriate to suggest alternative routes or whether no initiative is needed, from the Commission's side, regarding UGC.

We will hereafter analyse the various routes which the Commission, in our view, could theoretically follow. For each of them, we will try to describe the advantages and disadvantages which each such route may present.

We will distinguish between the actions which could take place within the current legal framework, i.e. without making any changes to the existing texts and to the Directive, and the actions which would involve changes to the existing legislation and/or to the Directive.

## **II. Possible actions within the existing framework**

The following initiatives would not involve any changes to the existing legislative framework.

---

<sup>1635</sup> This must be nuanced concerning the second and third step of the 3 step test and concerning the fair use analysis.

### A. Not taking any initiative

If we make a list of the possible options which exist, “not taking any initiative” is one of them. This option could be justified on the grounds that rightholders seem generally to tolerate UGC, that UGC is already flourishing (and therefore does not need any specific Commission action) and that there are already various mechanisms put in place by stakeholders (i.e. mainly content-sharing platforms but increasingly also micro licensing possibilities) to deal with UGC and to contribute to a revenue-creating stream for rightholders which provide users with legal certainty with respect to the re-use of protected content<sup>1636</sup>.

#### Advantage(s)

The legal framework is starting to deliver case law on which UGC cases can be assessed. In sectors such as music, contractual practice is increasingly providing legal certainty that the re-use (posting) of pre-existing works on those platforms with which agreements have been reached, is legitimate. “Doing nothing” would not destabilise the emerging market. This would also avoid the risk of increased litigation to “test the limits” of any new exception and the disruption of existing licensing solutions.

#### Disadvantage(s)

While we could not identify a significant “chilling effect” of the legal framework, there are uncertainties which could be clarified and differences in the laws of Member States which would gain from being harmonised (see other options *infra*). Not doing anything would not clear these uncertainties nor solve the fact that the legal situation is not harmonised amongst all Member States.

### B. Facilitating MoUs or other arrangements between stakeholders

Without changing the legislative framework, the Commission could decide to continue to encourage a dialogue between the various stakeholders concerned. There could be various results to such a dialogue.

The first pre-requisite would be for the parties to agree as to what the problem is, including the definition of UGC (as distinct from mere upload). Once agreement is found, then the Commission could have a role in facilitating a dialogue in which consumer representatives would act as a sounding board for initiatives by stakeholders and distributors to improve the user environment with respect to UGC.

In fact, this dialogue is what the Commission has launched via its “Licences for Europe” initiative. It is uncertain at the time when this report was written whether such initiative will lead to concrete results and whether it will allow an objective and sufficiently comprehensive view regarding the market and the situation of UGC.

Several MoUs have already been concluded in the field of copyright, such as the Memorandum of Understanding (MoU) on Key Principles on the Digitisation and Making Available of Out-of-Commerce Works or the Memorandum of Understanding (MoU) on access to works by people with print disabilities. This indicates that MoUs may provide for some additional comfort in certain sectors. It is noted, however, that in these instances, the signatories consisted of a finite list of organizations and their members, which had the power and governance structures to approve and implement the undertakings. It is difficult to see how this could be the case for parties other than rights holders and distributors.

One point would deserve to be further investigated. While a number existing monetizing arrangements cover both upload and transformative use (on the basis of automated content recognition), it has been

---

<sup>1636</sup> See however our remarks in this regard under point 2 hereunder.

highlighted by the Rapport Lescure submitted in May 2013<sup>1637</sup> that the arrangements concluded between some collective rights organizations and content-sharing platforms, do not always cover transformative UGC but often only “mere upload” cases. These arrangements should thus be improved to take into account the transformative UGC cases (and not be limited to mere-upload cases). Absent such revision, the transformative UGC cases (which correspond to the definition of UGC for this report) would not be covered by such arrangements; consequently, users would be left with the option of either relying on existing exceptions (with the problems which this causes and which we identify in this report) or obtaining the rightholder’s permission, which for many users would certainly appear as a significant obstacle.

### **Advantage(s)**

A possible MoU between rightholders and distributors on its coverage, help in increasing transparency and awareness. The advantage of such dialogue encouraged by the Commission is that it is based on a voluntary arrangement stemming from the parties concerned, that it may lead to concrete results in less time than what a change to the legislative regime would imply and that it may also be more flexible going forward, as an MoU could be revised to account for new developments more quickly and easily than a directive could be amended and adopted.

### **Disadvantage(s)**

At the same time, it has the disadvantages which are commonly attributed to such voluntary initiatives, such as the fact that the solutions may only be regarded as legitimate if they are the result of negotiations in which all parties concerned were duly represented and if their legitimate interests were taken into consideration. Also, the non-binding character of such voluntary mechanisms may mean that their endorsement is not guaranteed by non-signatories and that contradicting behaviours may continue to exist (even if there may be pressure on would-be outliers to play by the MoU because their non-cooperation compromises the effectiveness of the MoU for everyone else).

## **C. Adopting an interpretative document (such as a Commission Communication)**

Instead of waiting for the Court to further harmonize the exceptions to copyright set out by the Directive, piece by piece, somewhat haphazardly as the cases come up, the Commission could choose to draft and publish its own interpretative guidelines, not only on existing exceptions but possibly also on the freedom which users have, based on general copyright principles, to re-use pre-existing content and create UGC works.

The Commission has already taken such initiatives in the past and in various fields, in order to clarify the scope and the meaning of the European legislation (cf. *infra*).

In the field of copyright, WIPO has also published its interpretative guide to the Berne Convention. This guide was drafted by civil servants of WIPO, in order to clarify the provisions of the Berne Convention. The EUCJ has already referred to this guide, even if it is not legally binding, while interpreting the provisions of the Berne Convention in copyright cases.

Guidelines aim at clarifying the commented instruments, in the light of the available case-law, and at providing the author’s or institution’s view about their interpretation. They should, ideally, clearly specify that they do not provide an authentic interpretation of the commented instrument. Indeed, when EU directives are concerned, the CJEU has the exclusive power to give such authentic interpretation.

The first part of this Study showed important uncertainties concerning the legal status of UGC and the application of existing exceptions thereto. Discrepancies between national legislations, uncertainties

---

<sup>1637</sup> Pierre Lescure, Culture Acte 2, Mission « Acte II de l’exception culturelle », Contributions aux politiques culturelles à l’ère numérique (hereafter « the Rapport Lescure »).

concerning the territorial reach of UGC publishing on the internet, discussions about the level of harmonization reached by the Directive or uncertain material significance of some exceptions were the most important elements put forward.

A number of proposals examined further in this second part aim at reducing these uncertainties by modifying the Directive in several respects.

However, it may be argued that legislative action is not necessary and that such clarification might as well take place under the current legal framework. We are of opinion that the recent case-law of the EUCJ may lay the foundation for a more harmonized, flexible and “UGC-friendly” interpretation by the national courts of the exceptions set out by the Directive<sup>1638</sup>.

- **More harmonization.** This is one of the findings coming out of the analysis of the Court’s recent case-law on copyright. The use of various interpretative methods<sup>1639</sup> has led the Court to broaden the domain harmonized by the Directive and to reduce accordingly the margin of implementation enjoyed by the Member States. The Court has given its own autonomous interpretation of various concepts, even where the legislator in the InfoSoc Directive had clearly chosen to leave them to the discretion of Member States. In other cases, though, and quite contrary to the tendency just mentioned, the Court left the material content of certain concepts to the appreciation of national courts, without indicating clearly which concepts are eligible for an autonomous interpretation and which are not. A Commission’s interpretative document may help in understanding the CJEU’s case-law and its impact on UGC.
- **Less margin of appreciation for the Member States.** This is a logical consequence of the growing harmonization. The Court has recalled that exceptions must be implemented while bearing in mind the needs for harmonization and that inconsistent and un-harmonised national implementation by Member States of the same (optional) exception would be incompatible with the objectives of the Directive. The CJEU found itself providing its interpretation of (parts of) the material content of certain exceptions. It opposed Member States who added conditions to those explicitly mentioned in the text of the Directive in their national implementations of an exception (quotation). Even the optional character of the exceptions, although explicitly mentioned in the directive, could now arguably sometimes be challenged since the Court considered the exception of quotation as striking “*a fair balance between the right of freedom of expression of users of a work [...] and the reproduction right conferred on authors*”, which balance is “*struck by favouring the exercise of the users’ right to freedom of expression over the interest of the author*”<sup>1640</sup>. If the exception of quotation strikes a balance between copyright and freedom of expression, which is protected by various international instruments such as the ECHR and the Charter of Fundamental Rights of the European Union, it seems hard to defend that Member States are completely free to implement it in their national law or not. And what the Court said about quotation could, on the basis of the exact same reasoning, be transposed to parody, even if this exception is less straightforward and does have a basis in the Berne Convention itself.
- **“User-friendly” interpretation of the exceptions.** The exceptions derogate from the general principle established by directive 2001/29, namely the establishment of a high level of protection for the authors and the requirement of authorisation from the copyright holder for any

---

<sup>1638</sup> For a more detailed analysis about the Court’s case-law, see the first part of this report.

<sup>1639</sup> V.-L. Benabou, « Retour sur dix ans de jurisprudence de la Cour de justice de l’Union européenne en matière de propriété littéraire et artistique : les méthodes », *Propriétés intellectuelles*, n°43, April 2012.

<sup>1640</sup> Judgement of the Court of 1st December 2011, in Case C-145/10, *Eva-Maria Painer v. Standard VerlagsGmbH, Axel Springer AG, Süddeutsche Zeitung GmbH, Spiegel-Verlag Rudolf Augstein GmbH & Co KG, Verlag M. DuMont Schauberg Expedition der Kölnischen Zeitung GmbH & Co KG*.

reproduction. According to the Court, these principles may not be compromised by the national implementation of exceptions, which must therefore be interpreted strictly. Although the Court has not abandoned this principle of strict interpretation, which is still recalled in most of the cases, the recent case-law showed a slight shift of position in favour of the beneficiaries of the exception. The Court has affirmed the need to enable the effectiveness of the exceptions and, following a teleological approach, has verified whether the proposed interpretation of an exception complied with its purpose and did not hinder its effectiveness. In addition, the Court occasionally has weighted the balance of interests between the exclusive rights of the authors and the interests protected by the purpose of an exception and has found this balance striking in favour of the freedom of expression of the users of a work who benefit from the exception of quotation.

On one hand, the state of the affairs depicted here above is rather positive with respect to UGC (even if the CJEU never had to deal with UGC cases as such). The trend towards harmonization makes publication of content on the Internet simpler, as it reduces the need to take into account national particularities. The principle of “effective” interpretation of the exception and the balance of interests that should be made between the interests of the authors and the purposes protected by the exceptions, favours the inclusion into the scope of certain exceptions (quotation, incidental inclusion, parody) of a large number of UGC cases. These principles may justify, if one is to follow the reasoning of the EUCJ, a limitation to the freedom of the Member States to differ from the wording used in the directive, by e.g. adding conditions to benefit from the exceptions or by limiting the scope thereof.

On the other hand, these positive trends lack legal security and certainty. The Court pronounces itself only when and to the extent that questions are submitted to its jurisdiction. The principles described above are not much more than clues for solving questions that have not been examined yet; they do not always draw clear and consistent interpretative guidelines which may be as such used for all existing exceptions.

Therefore, instead of waiting for the Court to further harmonize the exceptions to copyright set out by the Directive, piece after piece, somewhat haphazardly as the cases come up, the Commission could choose to draft and publish its own interpretative guidelines.

As explained in the first part of our report, none of the exceptions taken separately could cover the great majority of UGC works; only by considering several exceptions does one cover, in our view, the majority of UGC (as we defined it). An interpretative document should thus, in order to be useful, deal with each of these (three) exceptions.

The Commission has already taken such initiatives in the past and in various fields, in order to clarify the scope and the meaning of the European legislation; see for instance the Guidelines on the interpretation of key provisions of Directive 2008/98/EC on waste published in June 2012<sup>1641</sup>, the Commission Interpretative Communication on the Community law applicable to contract awards not or not fully subject to the provisions of the Public Procurement Directives of 2006<sup>1642</sup> and the Commission Interpretative Communication on certain aspects of the provisions on televised advertising in the "Television without frontiers" Directive, published in 2004<sup>1643</sup>.

### **Advantage(s)**

In this type of document, the Commission would have the opportunity to emphasize the findings of the CJEU summarized here above about the exceptions to copyright. The document could also provide the Commission's views about a certain number of open questions. For instance (which is a personal view of

---

<sup>1641</sup> [http://ec.europa.eu/environment/waste/framework/pdf/guidance\\_doc.pdf](http://ec.europa.eu/environment/waste/framework/pdf/guidance_doc.pdf)

<sup>1642</sup> [http://ec.europa.eu/internal\\_market/publicprocurement/docs/keydocs/communication\\_en.pdf](http://ec.europa.eu/internal_market/publicprocurement/docs/keydocs/communication_en.pdf)

<sup>1643</sup> <http://eur-lex.europa.eu/LexUriServ/LexUriServ.do?uri=CELEX:52004XC0428%2801%29:en:HTML>



the authors of this report, given as an example only), the Commission could defend the view that exceptions protecting fundamental rights of the users of copyrighted works already provide sufficient flexibility (see *Painer*) and should thus be implemented by the Member States according to the wording of the directive, without adding further restrictions or conditions. This could apply to the exceptions of quotation and of parody, which arguably aim at enforcing the freedom of expression.

The Commission could, on the other hand, also provide its own interpretation of (currently) not harmonized concepts, such as “quotation”, “parody”, etc. , give indications or even its own view on the numerous questions which are mentioned in this report, and list (non exhaustively) the points on which Member States may still continue to diverge (based e.g. on the subsidiarity principle) in their implementation of the Directive.

Such approach combines the advantages of avoiding the lengthy and tricky legislative process required to modify the Directive, and the advantages of doing something in favour of a more consistent harmonization of copyright without waiting for the Court to do so, piece by piece, depending on the questions submitted to its jurisdiction.

Important arguments exist today in favour of a more harmonized and “user-friendly” interpretation of copyright exceptions, without need to modify the current legal framework. The Commission may take this opportunity to promote such interpretation by releasing a non-binding, but somewhat authoritative document.

For consistency reasons, it may make sense that the Commission defines its position somewhat *ex ante*, for the benefit of informing the market and the users at large rather than *case-by-case*, as and when a prejudicial question comes up. After an internal consultation exercise between the different DGs of the Commission, such Interpretative Communication on UGC (and more generally on the exceptions to the Directive or, even if not for all because this may prove too difficult, for those for which the exercise appears to be doable), such document could prove an interesting compromise between the present and, in certain instances, uncertain situation and a legislative adventure opening the Pandora’s box of exceptions... Thus, if the Commission decided that there was a need to do so, a more flexible and “UGC-friendly” interpretation of the existing copyright exceptions than currently appears to be the case in some Member States, could be suggested. This could prove useful when a case comes up before a Member State’s court.

### **Disadvantage(s)**

An interpretative, “soft-law” instrument certainly has downsides. Its legitimacy may sometimes be questioned as it arises neither from the legislator who has been democratically elected nor from the Court of Justice which is entrusted by the EU Treaties to interpret the Directives, but by experts or civil servants of an administration (as in the case of WIPO or of the Interpretative Communications from the Commission). It is indeed so that the Commission, while being the guardian of the *acquis*, does not have as its mission to give official interpretations of the directives, but at the same time, the Commission is always invited to give its own views when a prejudicial question is brought before the Court of Justice.

One should still not forget that the Commission’s own view of the effect of Community legislation, while it may be of interest and may have some weight, is clearly not binding on the Court, as recalled by Advocate General (par. 45) in the case C-306/05, *SGAE v Rafael Hotels, AG Sharpston*. Neither would such a Communication be binding on the Member States with respect to their implementation of the *acquis*.

## **D. Encourage education and information initiatives**

Some commentators have indicated that, as far as UGC is concerned, users in general do not know well what they may and may not do under national copyright law. It is not surprising as even experienced scholars may agree that it is difficult to explain easily what may or may not be done in that context.

However, as the need for education and information initiatives has already been mentioned more generally regarding copyright and the need to respect copyright principles, in the society's interest, the same may hold true regarding UGC : even if we could not find strong evidence regarding a possible "chilling effect" of the actual legal framework, some users (if they try to understand what the legal situation is) certainly wonder what they may do and may hesitate in engaging in UGC initiatives due to the lack of clarity of the legal regime and to the lack of harmonization between Member States.

One could think of initiatives which could be taken to give indications to users in general about what they may do with pre-existing works with which they want to make a parody, for instance. The difficulty of such initiative is that, given the fact that the situation is not harmonized in all Member States (about parody, for instance, and the conditions to respect for a parody to be legitimate), the guidance could hardly be clear-cut and simple. But some guidance directed to users would still be useful – be it to refer on certain issues to national legislations. Such education initiatives could probably not be managed by the Commission but might be delegated to external parties, possibly in concert with the Member States. Education initiatives might also be combined with an MoU in the sense that if an understanding (in an MoU) worked out, its terms could be publicized.

### **Advantage(s)**

The need for more information in the general public about what copyright is about, why it is beneficial to the society at large and not only to rightholders or producers, etc. has already been mentioned on different occasions by interested parties. Copyright as a mean to encourage creativity is more often questioned than in the past and its legitimacy is regularly put into question. This may come from the fact that the public is not sufficiently informed about how copyright works. Information campaigns are, up to now, mainly undertaken at the initiative of anti-counterfeiting associations. Maybe it would make sense to ensure that users (the public at large) be better informed about the existence of exceptions, such as parody, quotation, etc., which give them quite some room to engage into UGC initiatives. Arguably, such messages should not be brought by anti-counterfeiting associations but by other associations (such as consumer organizations, the education systems (schools) in the Member States, or civil rights organizations).

Such initiatives, taken together with education initiatives regarding copyright in general would at the same time (1) assist in explaining in particular to the younger generations what copyright is about and how/why it remains beneficial to the society at large by encouraging creativity through the rewarding of authors and (2) help in demonstrating that the existence of copyright, as being a system combining exclusive rights but also exceptions, does not prohibit each and every use of the works and is not just "something which makes producers rich" and, i.a. via the parody exception, allows everyone to create parodies of existing works and upload them on the internet without running the risk of being sued by the rightholders.

This type of initiative, about copyright in general and including UGC in its scope, would help in preserving copyright and ameliorate its understanding and endorsement by the younger generations.

### **Disadvantage(s)**

One of the disadvantages is that, in order for such campaigns to be sufficiently viewed, it may require an important budget and its efficiency is not guaranteed as it would rely on the openness of users and their readiness to listen to such message, which they might not want to hear. Another one – but this is more an obstacle than a disadvantage – is that it may at this stage prove complicated to convey a simple and straightforward message on UGC, considering the uncertainties which at the moment still prevail when one looks at the situation for the whole territory of the European Union (given the lack of a clear definition of the problem and of harmonization in the field of exceptions).

### III. Possible actions requiring changes to the existing framework

We will hereafter list initiatives which the Commission might take on UGC but which imply making changes to the existing legislation. We will mention changes to copyright legislation (the Information Society Directive), but also make reference to another directive, being the e-Commerce Directive.

#### A. Adapting and harmonizing the content of existing exceptions

As has been illustrated in the first part of our report, the relevant exceptions from the Information Society Directive are not harmonized at EU level. This means that, for a user who wishes to engage in a UGC project on the Internet and who first wants to assess what his risks are in terms of possible copyright infringement, such user should verify what the situation is in all Member States. As a result of such examination, if the user does not want to take any risk, he should (1) either adapt the message he wishes to convey to the rules prevailing in each country or (2), if he wants to only make one UGC work, align his initiative with, for each exception being examined, the most restrictive one, i.e. the most restrictive regime regarding quotation, the most restrictive one regarding parody and (3) the most restrictive one regarding incidental inclusion.

For the sake of completeness, one should add that such affirmation (as contained in the previous paragraph) only holds true in cases where no licences were available, allowing the user to make such UGC out of pre-existing works. In this regard, one should mention that various platforms provide that, when a user initially uploads an original work, he accepts that such work may be adapted, copied, parodied, etc. This may also be the case for works which were initially distributed under a Creative Commons licence (if the licence chosen by the creator is not a “No Derivative” licence).

We have no statistical figures regarding the number of users who hesitated in/abandoned the creation of a UGC work, and a layman’s observation of the Internet and of the Internet content-sharing platforms such as YouTube tends to indicate that many users did not hesitate at all and maybe did not even consider the question as to whether the UGC they uploaded (i.e., apart from “mere uploads”, mainly parodies) required the rightholder’s consent. However, it makes sense to consider that a harmonised situation in regard of the exceptions which are relevant for UGC (i.e., as explained in the first part of our report, quotation, parody and the exception for incidental inclusion), together with education and information initiatives/campaigns, would provide greater certainty to users and creators involved in UGC activities

All three exceptions at EU level have as their purpose to provide the right balance between the fundamental freedoms of right to property on the one hand and freedom of expression on the other. Freedom of expression is also the basis of some other exceptions from the InfoSoc Directive.

It is a fundamental right shared by all Member States, signatories to the European Convention for the Protection of Human Rights and Fundamental Freedoms (ECHR), which provides in its article 10 (**Freedom of expression**):

*1. Everyone has the right to freedom of expression. This right shall include freedom to hold opinions and to receive and impart information and ideas without interference by public authority **and regardless of frontiers**. This Article shall not prevent States from requiring the licensing of broadcasting, television or cinema enterprises.*

*2. The exercise of these freedoms, since it carries with it duties and responsibilities, may be subject to such formalities, conditions, restrictions or penalties as are prescribed by law and are necessary in a democratic society, in the interests of national security, territorial integrity or public safety, for the prevention of disorder or crime, for the protection of health or morals, for the protection of the reputation or rights of others, for preventing the disclosure of information received in confidence, or for maintaining the authority and impartiality of the judiciary” (emphasis in bold added).*

The EU Parliament, the Council and the EU Commission have also adopted in 2000 the Charter of Fundamental Rights of the European Union, which provides in its article 11 (Freedom of expression and information):

*“1. Everyone has the right to freedom of expression. This right shall include freedom to hold opinions and to receive and impart information and ideas without interference by public authority **and regardless of frontiers**”* (emphasis in bold added).

One might therefore hope that Member States are eventually able to agree on what should be acceptable under the three exceptions under consideration and how to harmonize them further. Without underestimating the difficulty of such exercise, considering that an analysis of the case-law is difficult for it is always very much a case-by-case solution to a specific situation where factual circumstances play an important role, and while not forgetting that the right to property (including to intellectual property) is also protected by the ECHR and the Charter, one cannot in our view deny the interest which a greater harmonization of exceptions would present (and this holds true not only for UGC). As in all harmonizing efforts, the way to the solution may neither be straightforward nor obvious but could, in our view, be tried.

Some commentators have argued that the Directive as such, without changing it, already allowed sufficient leeway for the Member States to promote UGC if they so wished. Some invoked the fact that the adaptation right was not part of the Directive to say that UGC could be introduced (and allowed) via this route (subject of course to the three-step test)<sup>1644</sup>. Others stated that the Directive allowed also sufficient leeway in the definition of some of the exceptions to introduce UGC via a modification, not by an amended Directive (which would take too much time) but by amending the national implementing legislation regarding the existing exceptions in order to allow UGC with more certainty than is now the case; this is i.a. advocated in by the Dutch Copyright Commission, which suggests to adapt the quotation exception to further allow UGC<sup>1645</sup>; the Dutch Copyright Commission is of the opinion that the parody exception would probably, when interpreted by the CJEU, receive a too narrow interpretation to sufficiently shelter UGC (due mainly to the humoristic or satiric requirement of parody in many Member States). It will in this regard be interesting to see the answers which the CJEU will give to the questions which have just recently been referred to her regarding parody by the Brussels Court of appeal<sup>1646</sup>.

One could draw a further argument from the words of both articles quoted above which we highlighted in bold (“*and regardless of frontiers*”), to be found similarly in both texts, as a reason to ensure that freedom to receive and impart information should be safeguarded in a uniform manner throughout all Member States. This implies that the exceptions to copyright which have as their main purpose to enable such freedom of expression should be interpreted and applied in a harmonized manner, so that the freedom of expression (to distribute or to receive information) not be restricted more in one country than in another.

<sup>1644</sup> See also what we say about the adaptation right in relation to the parody exception, *infra*.

<sup>1645</sup> See, in favour of a broadening of the quotation right (more than of the parody exception) in order to further allow UGC, the Dutch report of the Copyright Commission (Commissie Auteursrecht), dd. 21 March 2012, available at <http://www.rijksoverheid.nl/onderwerpen/intellectueel-eigendom/documenten-en-publicaties/rapporten/2012/10/30/advies-een-flexibele-regeling-voor-user-generated-content.html>

<sup>1646</sup> The Court of appeal of Brussels, in its arrest dd 8 April, 2013 (**Deckmyn v Vandersteen en Vrijheidsfonds VZW v. Vandersteen**) raises the following questions to the EUCJ (Request for a preliminary ruling from the Hof van beroep te Brussel (Belgium) lodged on 17 April 2013 — Johan Deckmyn, Vrijheidsfonds VZW v Helena Vandersteen and Others, (Case C-201/13) (2013/C 189/11):

1. Is the concept of ‘parody’ an independent concept in European Union law?
2. If so, must a parody satisfy the following conditions or conform to the following characteristics:
  - the display of an original character of its own (originality);
  - and such that the parody cannot reasonably be ascribed to the author of the original work;
  - be designed to provoke humour or to mock, regardless of whether any criticism thereby expressed applies to the original work or to something or someone else;
  - mention the source of the parodied work?
3. Must a work satisfy any other conditions or conform to other characteristics in order to be capable of being labelled as a parody?

This pleads for a uniform interpretation and application of the exceptions we have highlighted as relevant to UGC, being quotation, parody and incidental inclusion. The Commission might find it opportune to express such opinion in the “interpretative document” discussed above.

Going one step further, this might also suggest some changes to the Information Society Directive to the effect that these exceptions be harmonized in more detail, so as to leave less margin of discretion to legislators and courts in the Member States and to ensure that, on the contrary, the exceptions be given a uniform interpretation (in the same way as the articles on freedom of expression of the ECHR and of the Charter should normally receive a uniform interpretation throughout the Union).

Consequently, the Commission could propose amendments to the Information Society Directive to the effect that the exceptions regarding parody and pastiche, the exception regarding quotation and the exception regarding incidental inclusion be further specified so that their implementation in the legislation of the Member States would not leave such Member States with any (or hardly any) margin of interpretation. One could argue that this is contrary to the philosophy of harmonization through directives, but the EUCJ has already expressed the view that the wording of an exception in the Information Society Directive, even though the list was optional, could not be interpreted and implemented in a different way than in the way the text of the Directive had been intended<sup>1647</sup>. So, such initiative from the Commission could find some comfort in some case-law of the EUCJ.

When adopting either the interpretative document suggested above or drafting changes to the Information Society Directive, the Commission could seize the opportunity to indicate clearly to what extent these exceptions are relevant for UGC. This would greatly clarify the situation for all stakeholders concerned.

One difficulty of such exercise (i.e. further harmonizing these three exceptions) stems from the fact that, in the Information Society Directive, the adaptation right has not been harmonized and, a *fortiori*, that exceptions to the adaptation right have not been provided<sup>1648</sup>. This leaves the Commission with two options:

- Either take the route of harmonizing the adaptation right, but this may prove very difficult in the actual situation and raise a list of additional questions flowing from the intention to harmonize the adaptation right;
- Or provide, in the amended text of the Directive, that exceptions are to be interpreted as exceptions to all exclusive rights which may exist (which means, also to the adaptation right) and which would be contrary to the exercise of such exceptions: without harmonizing the adaptation right, this would result in ensuring that the exceptions will be applied despite the further subsistence of the adaptation right outside the realm of the Directive. This may not be a very elegant solution and the drafting of such provision may not be easy but the fact that the adaptation right is not harmonized does not *per se* constitute, we think, an insurmountable obstacle to this exercise.

It is unquestionable that by harmonizing these three exceptions and even making them compulsory, one would still not cover all UGC cases, but our view is that it would cover the greatest part of it, and at the same time the most interesting part of UGC in terms of freedom of expression and added-value to the society at large and to the exchange of ideas and development of culture. Arguably, if parodies are, under certain conditions, allowed, if quotations are, under certain conditions, allowed, and if incidental inclusions are held not to be infringing copyright, then we tend to think that the most valuable UGC works (again, in terms of freedom of expression, expression of new ideas and contribution to the exchange of ideas and the development of culture) will be safe-harbored. If a small part of UGC falls through the

---

<sup>1647</sup> See Premier League case, par. 163.

<sup>1648</sup> As indicated in the first part of our report.

safety net of these three exceptions, it may well be that it is because it is not really worth protecting. In such cases, it is more than probable anyway that neither the author of the UGC work has any hope of deriving revenue from it nor the rightholder has any intention to devote efforts and spend costs to engage in legal proceedings and obtain a “take down” or damages: the result is that such valueless works will hang out and stay on the Net, but in a general sphere of disinterest from everybody. As stated, “*de minimis non curat praetor...*”.

It goes beyond the scope of this report to draft the texts for such revised exceptions but several issues will have to be considered if the Commission wishes to propose a new wording for these three exceptions :

- **Regarding quotations:** for which (exhaustive?) purposes are they allowed? Should they be short (whatever “short” means) or sometimes possible for a whole work (such as a pictorial work)? Should they be allowed for all kinds of works, including newspaper articles or press summaries? Should they only be allowed if inserted in a work or be allowed to exist on their own? May they be made for commercial purposes also? What would mean a reference to conformity with “fair practice”? Should they always (at least when feasible) mention the source (author and/or work)? Are they allowed for political propaganda? Should they be limited to what is strictly necessary? Should they only be allowed for works made publicly available with the author’s consent? Should they be in conformity with “fair practice” or “fair professional uses” or not conflict with “honest practices” (whatever these words may mean)? Are translations of (short?) quotations allowed?

The initial proposal by the Commission in the draft Directive was not altered substantially during the legislative process, so that one may infer that a rather broad consensus exists amongst the Member States, but “the devil is often in the details” and if the proclaimed idea is to render the exception more precise and compulsory, divergences may reappear on a surface which seemed rather calm.

Also, most Member States already had a quotation exception of some kind even before the adoption of the Information Society Directive, so that the idea of making such exception compulsory should not spur revolution amongst the Member States.

We know that the EUCJ answered a number of questions regarding quotations in its Painer decision, yet some questions remain unanswered.

The Lescure report , submitted to the French President on May 13, 2013, suggests for, French law, and in order to accommodate the non-commercial UGC uses, to study the possibility to envisage a broadening of the quotation exception so as to cover, while staying within the limits of quotation exception of the Copyright Directive, non-commercial “creative or transformative” purposes (while recognizing that the “transformative purpose” would require further analysis) ; the “non-commercial” character would mean that uploading giving rise to advertising revenues and arrangements giving rising to the sharing of advertising revenues would not be covered<sup>1649</sup> .

- **Regarding parody:** as the Berne Convention does not provide for such exceptions, we have illustrated in the first part of our report that some countries have traditionally accepted it, be it via case-law or via an explicit exception in their copyright legislation, and that some have not. Questions which would have to be examined include the following: should one make a difference between parody, caricature or pastiche? Should the exception respect “honest trade practices” or “social customs” (whatever these terms may mean)? May they borrow much or only as little as is strictly necessary from the pre-existing work? Should they have as their main (or sole) purpose to mock the author, or the work? Or may parodies have as their purpose to convey commercial or political (electoral) messages? May they cause prejudice to the reputation or honour of the author and thereby infringe upon the moral right of integrity of

---

<sup>1649</sup> The Lescure report further suggests (without elaborating it further) that it may be a good idea to think at the European level about the possible introduction of a new transformative use exception to cover UGC cases.

the author? Should they necessarily be humorous? Should they avoid all possible confusion with the initial work or all possible risk that the parody be seen as originating from the author of the initial work (some authors like to practice self-parody)?

As mentioned above, the CJEU has very recently received a request for a preliminary ruling by the Brussels Court of appeal and will thus have the occasion to answer several questions put to it regarding the notion of parody.

Fuelling this idea to further promote the parody exception is the very recent report by the IPO in the UK, which, on the basis of an apparently large empirical study, illustrates that the existence of parodies in the UK (even though not explicitly allowed by legislation) has apparently no demonstrable impact on the exploitation of the work, neither negatively nor positively. The study concludes that correlation between the success of the work and the number of existing parodies (without concluding decisively about the causal relationship – yet one may suspect that the more successful the work, the more parodies it will inspire); it illustrates that, even for the works (the study is limited to music video clips on YouTube in 2011) which have been most parodied, the proportion of views of the parodied version remains insignificant in comparison with the number of views of the original, thereby reinforcing the idea of the report that allowing parody would have no detrimental impact on existing works, might on the contrary have a (little) positive impact and in any case, in a society of free expression and free speech, should be explicitly allowed by the law.

Very recently, the UK Government has announced its intention to introduce an explicit parody exception (due to be introduced in October 2013)<sup>1650</sup>.

It was recognized, in the consultation conducted by the UK Government, that there is a growing trend for user-generated, often non-commercial, parody content on YouTube and similar websites.

The UK Government announced its intent to legislate to allow limited copying on a fair dealing basis for parody, caricature and pastiche, while leaving the existing moral rights regime unchanged. The following extracts from the report are worth reproducing here:

*“It (the Government) considers that this permitted act will provide economic and cultural benefits by removing unnecessary restrictions on the activity of some creators, reducing administrative costs, and encouraging creators, without causing any significant economic harm to holders of rights in the parodied content. The requirement that any parody use of a work be ‘fair dealing’ is an additional restriction which ensures that the exception is not misused, and will preclude the copying of entire works where such taking would not be considered fair (for example if such works are already licensable for a fee). The existing moral rights regime will be maintained unchanged, so that creators will be protected from damage to their reputation or image through the use of works for parody.*

*In addition to the benefits to parodists outlined above, of allowing easier production of parody works, there are compelling social and cultural benefits such as the development of free speech and the fostering of creative talent. The wider public would also benefit from increased legal clarity and opportunities for freedom of expression when creating parody for non-commercial reasons. The Government agrees with the Business, Innovation and Skills Select Committee that genuine political and satirical comment should be protected. “*

A difficulty when wanting to further harmonize parody is that the adaptation right is not as such harmonized and remains outside the scope of the Directive (unlike for computer programs and databases). Yet one can probably rely on the very broad definition of the reproduction right, covering many kinds of reproductions (“direct or indirect, temporary or permanent reproduction by any means and

---

<sup>1650</sup> See draft exceptions for technical review at: <http://www.ipa.gov.uk/types/hargreaves/hargreaves-copyright/hargreaves-copyright-techreview.htm>

in any form, in whole or in part” – see article 2 of the Directive). Here again, the absence of harmonization of the adaptation right, as well as the fact that moral rights are not harmonized, can create difficulties but we think this does not as such make it impossible, we think, to intervene somewhat further in the harmonization of the parody exception<sup>1651</sup>.

- **Regarding the incidental inclusion:** as the Berne Convention does not impose such exception either, one has to look at what the Member States did when implementing (or not) the exception. The questions which would gain from being clarified, in the absence of any case-law from the EUCJ on this, from the users’ perspective and for more legal certainty, include the following: what does “incidental” actually mean? Does it mean “in the background” (of a wedding dance party video, for instance) or rather “accidental”, or “unintentional”, i.e. “accessory to the recording of another event, the latter being the main subject matter of the including work”? Does it imply that the recording be of a lower quality than that of the original (which, with the advance of technology, is less and less likely to be the case)? Does it cover all types of works, or only architectural ones? At the exclusion maybe of musical ones and of performances? Is it only allowed if its inclusion is in practice unavoidable when recording the main event/work? Can it only take place when reporting current events?

It has been shown in the first part of the report that many countries did not introduce this exception in their legislation, leading in principle judges in these countries to conclude that such exception does not exist and that there is infringement – safe for the possibility to rely on other arguments outside of copyright (see first part of our report).

### **Advantage(s)**

In our view, harmonizing the content of these three exceptions would give a clearer picture on the situation prevailing in the European Union. The present (not harmonized) situation is not easy to deal with if a UGC creator wishes to comply with all applicable rules. It would also facilitate education and information campaigns on the legal rules applying to UGC. Even if no substantial evidence could be gathered regarding a possible chilling effect of such legal framework, it is only logical to consider that a harmonized regime on these three exceptions will make the situation clearer for UGC users who wish to comply with the rules.

### **Disadvantage(s)**

We cannot immediately think of many disadvantages. Obviously, harmonizing the Member States legislation on these exceptions may not be devoid of difficulties, for some Member States may be very reluctant to accept it. Yet this is a “difficulty”, not as such a “disadvantage”.

## **B. Adapting the characteristics of existing exceptions**

Another possible route, which may accompany the first one mentioned above, would be to bring changes to the characteristics of the exceptions (i.e. to their legal status). We will discuss two possibilities: making them **compulsory** rather than facultative for Member States; and making them **unwaivable** for the parties to a contract.

### **1. Making the three exceptions compulsory?**

It has been criticized by many (the fact is well known and does not even require that we bring evidence of such criticism by referring to a list of legal scholars and to scholarly literature) that the exceptions were optional and that their adoption was left to the discretion of the Member States’ legislators. It is

---

<sup>1651</sup> Otherwise, this should arguably have made any attempt at harmonizing parody impossible from the beginning, yet the InfoSoc Directive already goes a certain way in this direction.



noteworthy that the facultative character of the exceptions was proposed as from the first proposal by the Commission of a text for the Directive, so that this is not a concession which was made during the legislative process.

However, the result is what it is, i.e. a very disharmonized picture, with every country having made its shopping-list in the catalogue. If one considers that it is important that exceptions which originate not so much from market failure but from the necessity to safeguard fundamental rights or freedoms, such as the right of expression, a logical consequence would be to make a second change to the mechanism provided for by the list of exceptions and decide that some exceptions should be made mandatory, like it is the case now for the exception of article 5.1. of the Directive, so that Member States would be obliged to adopt them and in the more precise wording which the Commission, in accordance with our previous recommendation, would have suggested.

We do not think that the proportionality principle or the subsidiarity principle *per se* justify that each exception in the catalogue list remains optional for the Member States. Directives are *per se* instruments which leave some discretion to the Member States as to the means to be put in place to reach the objectives of the directive; but that obviously does not mean that a directive should always only include "optional" lists. Quite on the contrary, if the Member States are left free to decide the means to reach the objectives, they are nevertheless under an obligation to meet the objectives of the directive. Making the exceptions mandatory would only align the regime of the Directive with the regime of the greatest majority of harmonizing directives.

### **Advantage(s)**

We are here dealing with the idea of making some of the exceptions mandatory and it should be made clear from the outset that our observations do not necessarily hold true for all exceptions and that a differentiated treatment of the exceptions in the list may be justified. For the exceptions under consideration, if the exceptions, via an amendment to the Directive, would be made compulsory for the Member States, it would facilitate the verification that a normally prudent UGC creator should do (yet probably does not often do) before uploading its UGC work on an international platform, without having to wonder about "where what is permitted and where not", where parody may be commercial and where not, where incidental inclusions include musical works or not, etc.

### **Disadvantage(s)**

A difficulty (more than a "disadvantage") of this option is that it implies modifying the Copyright Directive, which may not be easy (despite our observation made earlier that Member States should in principle be sharing rather similar views regarding the proper balance between exclusive rights, exceptions and freedom of expression). Also, finding such proper balance and put in down in articles of a future directive may not be easy.

Another disadvantage is that it will impose new rules on Member States which, for instance, did not have an explicit parody exception in their legislation. This may lead to resistance. However, as indicated, all Member States ratified the most important declarations and charters on freedom of expression. One should hope that the times are now ripe for a common approach, via the Union, on these issues which combine copyright (all Member States having ratified the main international Conventions and adopted many harmonization directives) and freedom of expression (where the same observation may be made). Optimism should lead one to think that a compromise should be reachable on the wording of compulsory exceptions, yet this is obviously hard for anybody to predict.

## **2. Making the three exceptions imperative/unwaivable ?**

Finally, *if* the purpose is that the exceptions can always be relied upon by users, even when they are first invited to accept standard clickwrap terms and conditions, *then* a further logical step would be to decide that such exceptions be made "imperative" (as so called in civil law countries), or in other words

unwaivable by contract (we are dealing here with the situation where there is a contract (usually, standard clickwrap terms and conditions) between the user and the rightholder/publisher (or platform)<sup>1652</sup>. The same reasoning may be held for the quotation exception and for the parody exception but probably not for the incidental inclusion exception (since there is, in that case, almost by definition, no possible contractual link between the user and the rightholder whose work has been incidentally reused). Making some of the exceptions unwaivable by contract, particularly those which exist not due to some sort of market failure but result from freedom of expression considerations, may make sense.

The consequences thereof certainly deserve further study. Some countries like Belgium have already provided that copyright exceptions were unwaivable by contract; it does not seem that this has led to dramatic consequences for rightholders. In consumer law legislation, many provisions protecting the weaker party have been made unwaivable<sup>1653</sup>; it would seem to us that there are comparable reasons to adopt similar mechanisms in copyright law, for certain exceptions at least.

If one is of the opinion that making an exception unwaivable is too far-reaching a method or too simplistic, an alternative could be to distinguish between adhesion contracts and contracts that are negotiated (one could may be add: “at arm’s length”): exceptions would only be unwaivable in adhesion contracts and not in negotiated contracts.

By suggesting this however, we are not suggesting that all exceptions to copyright should be made mandatory<sup>1654</sup>. Some have clearly stated that a case-by-case (exception-by-exception) analysis should be made, before deciding, for each exception, whether it should be made unwaivable or not<sup>1655</sup>.

### **Advantage(s)**

Clearly, the main advantage is that the most powerful party in the negotiation (in most cases, the the publisher) will not be able to require waiver of the exception, generally via clickwrap terms and conditions which are not negotiable and are of a “take it or leave it” nature.

It would ensure that the exceptions, once made mandatory, may not be waived by contract. This could be seen as a necessary and logical accompanying measure to making them mandatory for Member States. To a certain extent, as the French expression goes, “*il faut vouloir les conséquences de ce que l'on veut*”.

### **Disadvantage(s)**

The main disadvantage is that parties lose all margin of negotiation and that this may not facilitate certain transactions. It could lead to a situation where a rightholder, because he cannot reserve some uses (exceptions), decides not to grant any licence to the candidate user and that, due to that, some transactions which would otherwise have led to some exploitation of a work, are not concluded in the end.

Another difficulty needs to be assessed, i.e. how should this be reconciled with the existence of moral rights. To some extent, the author will be limited in the exercise of his moral rights if he cannot oppose a *priori* (via contractual terms) quotation or parody of his works, totally or – as this is more likely to happen –

<sup>1652</sup> This is the reasoning behind the legislation which, in a few European countries, have provided for such unwaivability of certain (or all) exceptions.

<sup>1653</sup> In the field of copyright, the EU directive on the legal protection of computer programs, the back-up copy and the decompilation exception have been made unwaivable.

<sup>1654</sup> On this subject, see the PhD thesis by Lucie Guibault (IVIR, 2002), Copyright Limitations and Contracts: An Analysis of the Contractual Overridability of Limitations on Copyright.

<sup>1655</sup> See e.g. Dr de Werra : « *Une deuxième piste - et là je m'inscris peut-être moins dans la ligne de Mme Dusollier et davantage dans celle du Prof. Schwarz – et qu'il me semble que la solution qui est notamment celle de la loi belge relative au droit d'auteur et aux droits voisins (art. 23bis), qui prévoit que toutes les exceptions au droit d'auteur sont de nature impérative, n'est pas souhaitable. Il me paraît au contraire qu'une solution différenciée en fonction de l'importance respective des diverses exceptions devrait être adoptée* ». Available at [www.ip.mpg.de/files/pdf1/TagungInteressenausgleich-2-Diskutant1.pdf](http://www.ip.mpg.de/files/pdf1/TagungInteressenausgleich-2-Diskutant1.pdf)

partially, for instance in certain contexts (e.g. use of quotations for political propaganda) ? On the other hand, the existence itself of the quotation exception and of the parody exception entails limitations to the moral rights of the author (paternity for quotations, integrity for parodies) but this is not new. And the question could be asked as to whether such contractual terms (prohibiting parody or quotations, totally or - more likely – partially) would not be held invalid. On this, like on other issues, a balance needs to be struck between diverging rights and interests.

### 3. An additional question: who should be the beneficiaries of the exception?

Independently of the question of whether the exceptions should be made mandatory for Member States or unwaivable for parties, the question arises as to who should be the beneficiaries of the exceptions. In our view, the beneficiaries of the exception should only be those who actually “created” the UGC work (i.e. relied on a pre-existing work and in some way modified it) and who make no commercial exploitation of it (i.e. not derive financial benefits from it, directly or indirectly<sup>1656</sup>).

The exception should however not benefit third parties who derive commercial benefits from such use by the “creators”: for instance, the platform on which the UGC is uploaded and which derives benefits thereof thanks to advertising revenues or other forms of revenue streams (e.g. subscriptions) should not be given the possibility to find shelter under these exceptions and thereby avoid having to negotiate agreements with rightholders to obtain their authorizations for such commercial exploitations and/or to come to monetizing agreements with the rightholders.

Granting the benefit of such kind of exception to commercial exploitations of UGC by large economic operators would, at least we think, not pass the three-step test and should not, in our opinion, be envisaged.

When platforms propose to rightholders some sort of monetizing arrangements, it is on the assumption that they may run into problems if the rightholders ask to “take down” their contents, which will at the same time make the platform less attractive for visitors and thus generate less advertising revenues. The system of exceptions, if it is adapted to facilitate/promote UGC, should not have as a result that the content-sharing platforms on which the UGC works have been uploaded may feel sheltered thanks to the change of legislation and have then no more reasons to come to terms with rightholders and share part of the revenues generating by the views of the videoclips. This entails that, if one adapts the exception to excuse UGC made by certain users, a distinction must be kept between commercial and non-commercial uses or maybe between different categories of beneficiaries. So, even if the end-user’s (non commercial) act is considered as not infringing, the exception should not benefit the platform (which is making a commercial use of the user’s UGC). The platform would be reproducing/communicating a non-infringing work but should still be liable because it does so for commercial purposes. The platform’s reproduction or communication entails no creativity on the part of the platform, and is commercial, so the basis for non-liability which would excuse the end-user would not exist for the platform.

This objective may not be very easy to implement into new legal provisions, because various questions can be raised, at the crossroad between the InfoSoc Directive and the e-Commerce Directive: in which cases is there no involvement of a platform? Could the platform be liable and the user not be, while the work at issue (uploaded by the user and hosted on the platform’s website) is the same? What about the posting of UGC on one’s own website or blog (which will often not be commercial? What about platforms that operate on a non-commercial basis (certain news groups, Internet fora etc.)? This raises questions regarding contributory liability (which is not a harmonized concept), and liability of intermediary service providers under the Electronic commerce Directive and its safe harbour provisions? Could there be

---

<sup>1656</sup> Maybe our reference to « indirectly » should deserve further consideration before keeping these users outside of the scope of the exception. Also, as stated earlier, the distinction between commercial and non-commercial uses is difficult to draw, for UGC as for other sectors alike.

cases where a platform is under the obligation to obtain a licence from the rightowner of the initial work while at the same time not be obliged (because no initial copyright infringement by the user occurs on the platform of the service provider) to act expeditiously to take the content (UGC) down? And if the platform is not under such obligation to take the content down, will there still be sufficient incentive for platforms to negotiate monetizing agreements and other forms of licences with the rightholders (which is a development which should be encouraged)?

It may thus be that in order to arrive at this result, some additional provisions will be needed. It is not impossible that this may require some fine-tuning or changes to the eCommerce Directive. We cannot examine this at this stage but this clearly deserves due consideration before any decision on the preferred course of action is taken.

Another issue which may deserve the attention of the Commission, when analyzing the monetizing arrangements proposed by the major platforms, is that, as far as UGC works are concerned, our impression is that the sharing of the revenues takes place between the platform and the authors of the pre-existing work, but much less with the creators of the UGC work, such as the parodists. Yet, in some instances, even if a recent report from the IPO<sup>1657</sup> shows that the number of views of parodies remain almost insignificant in regard of the number of views of the original work, one could think of a situation where much more creative effort was put in the parody and/or where little remains of the initial work in the UGC parody, so that it would seem fair that the sharing of the revenues takes place between the three actors in the game: the author of the initial (parodied) work, the creator of the UGC work and the platform on which the UGC work (the parody) has been uploaded (and not just between two actors). Wikipedia mentions some examples where the user is rewarded by explicit (financial) rewards, which incentives include financial payment, entry into a contest, a voucher, a coupon, or frequent traveler miles<sup>1658</sup>; this issue might deserve further consideration (for if the creator is being remunerated, would that not conflict with the basis for finding the UGC creator not liable?)

### C. Adopting an explicit UGC exception

Another route which the Commission could decide to suggest is to create a new provision in the Directive to deal with UGC. This should normally be done via the addition of a new specific exception to the list of article 5.2.

It is worth mentioning that, to our knowledge, only one country has embarked upon this avenue, i.e. Canada, via the new article 29.21 of its Copyright Act<sup>1659</sup>. It is sometimes said that other countries

---

<sup>1657</sup> Kris Erickson, Evaluating the Impact of Parody on the Exploitation of Copyright Works: an Empirical Study of Music Video Content on YouTube, Independent report commissioned by the Intellectual Property Office, Study 1, January 2013, 2013/22.

<sup>1658</sup> [http://en.wikipedia.org/wiki/User-generated\\_content](http://en.wikipedia.org/wiki/User-generated_content)

<sup>1659</sup> The article reads as follows :

#### *Non-commercial User-generated Content*

**29.21 (1)** *It is not an infringement of copyright for an individual to use an existing work or other subject-matter or copy of one, which has been published or otherwise made available to the public, in the creation of a new work or other subject-matter in which copyright subsists and for the individual — or, with the individual's authorization, a member of their household — to use the new work or other subject-matter or to authorize an intermediary to disseminate it, if*

*the use of, or the authorization to disseminate, the new work or other subject-matter is done solely for non-commercial purposes;*

*the source — and, if given in the source, the name of the author, performer, maker or broadcaster — of the existing work or other subject-matter or copy of it are mentioned, if it is reasonable in the circumstances to do so;*

*the individual had reasonable grounds to believe that the existing work or other subject-matter or copy of it, as the case may be, was not infringing copyright; and*

*the use of, or the authorization to disseminate, the new work or other subject-matter does not have a substantial adverse effect, financial or otherwise, on the exploitation or potential exploitation of the existing work or other subject-matter — or copy of it — or on an existing or potential market for it, including that the new work or other subject-matter is not a substitute for the existing one.*

(Israel, South Korea) also have a UGC exception<sup>1660</sup> while in fact these countries rely therefor on a “fair use” approach but not on a specific UGC exception. The non-commercial UGC exception, often referred to as the “YouTube exception” or “mashup exception”, was one of a series of new provisions introduced into the Canadian copyright legislation to increase consumers’ rights.

The new Copyright Act (Bill C-11, entitled the “Copyright Modernization Act”) came into force on November 7, 2012. The other consumer oriented provisions include the addition of education, parody, and satire as fair dealing purposes, time shifting (recording of television shows), format shifting, and the making of backup copies.

Under the new Canadian law, a safe harbor is created for both UGC uploaders and sites hosting such UGC content provided that basically the following conditions are met:

- The pre-existing work had been published;
- It is used to create a new work (so the mere copying is not covered by this provision);
- The use of the new work if done solely for non-commercial purposes; a commentator stated that that such non-commercial purpose is only required from the creator of the UGC work, and not from the intermediary (like Facebook or other content-sharing platforms)<sup>1661</sup>; considering the comments by the Canadian Government (see hereunder), this statement might not be correct, since the Government stated that “*this provision applies only to the UGC creator of such works and only for non-commercial purposes*”<sup>1662</sup>;
- The source and name of the author are mentioned, if it is reasonable in the circumstances to do so;
- The person had reasonable grounds to believe that the existing work (or other subject-matter) was not infringing copyright;
- The use (meaning both the upload by the user or the hosting by the intermediary) of the new work does not have a substantial adverse effect, financial or otherwise, on the exploitation or potential exploitation of the pre-existing work or on an existing or potential market for it, including that the new work or other subject-matter is not a substitute for the existing one.

The law, when adopted, was described as “*a bill (...) that has its flaws but also creates some of the most expansive copyright user rights in the world*”<sup>1663</sup>.

Not surprisingly, the bill has not been welcomed by all. The Writers’ Rights Coalition stated the following (before the adoption of the bill): “*(...) there is nothing to ensure that any such new use will be fair.*”

#### Definitions

(2) The following definitions apply in subsection (1).

“intermediary” means a person or entity who regularly provides space or means for works or other subject-matter to be enjoyed by the public.

“use” means to do anything that by this Act the owner of the copyright has the sole right to do, other than the right to authorize anything.

<sup>1660</sup> The same is sometimes said, regarding the same countries, about the existence of a text and datamining exception.

<sup>1661</sup> Mihály Ficsor, “Comments on the UGC provisions in the Canadian Bill C-32: potential dangers for unintended consequences in the light of the international norms on copyright and related rights”, October 23, 2010, p. 15, available at [http://www.copyrightseesaw.net/archive/?sw\\_10\\_item=31](http://www.copyrightseesaw.net/archive/?sw_10_item=31)

<sup>1662</sup> Cf. infra.

<sup>1663</sup> <http://www.michaelgeist.ca/content/view/6692/125/>

*Professional writers may not object in principle to others incorporating reasonable excerpts from their works into new creative works as long as they are credited and the use is truly non-commercial and if the new work does not interfere with the market for the original work. However, distribution of these so-called "mash-ups" by commercial disseminators such as Facebook or YouTube without payment encroaches peremptorily and unfairly on writers' rights. Whether there is "a substantial adverse effect" on the original work, which would result in an infringement, will not be known until too late and may depend on how many others create "mash-ups" using the same work. This feature of C-32 represents an erosion of rights that does not exist anywhere else in the world and that would certainly put Canada in breach of the Berne Convention and similar international obligations.*"<sup>1664</sup>

The Canadian Government commented by stating that "*the Bill permits the use of legitimately acquired material in user-generated content (UGC) created for non-commercial purposes. This applies only to creations that do not affect the market for the original material. Examples include making a home video of a friend or family member dancing to a popular song and posting it online, or creating a "mash-up" of video clips. This provision would not permit such activities as simply adding a few lines to an e-book or a brief introduction to a song and then posting the copy for free online, or re-ordering the tracks on an album and selling CDs at a flea market. Creators' moral rights would also continue to be respected. Moreover, this provision applies only to the UGC creator of such works and only for non-commercial purposes*".<sup>1665</sup>

Mihály Ficsor, quoting both the (2003) WIPO Guide to the Berne Convention<sup>1666</sup> and Sam Ricketson and Jane Ginsburg<sup>1667</sup>, recall that Member States to the Berne Convention must provide for an exclusive right of adaptation which must at least cover changes of the original work resulting in a derivative work<sup>1668</sup>, challenges the comments made by the Canadian Government (as quoted above) and concludes that the UGC provision of the Canadian Copyright Act is in breach of international treaties<sup>1669</sup>. He is of the opinion that the Canadian Act does not respect the moral right of integrity provided for by the Berne Convention nor the adaption right nor the making available right provided for by (i.a.) Article 8 of the WCT.

The authors of the present report generally agree with Ficsor when he states that : "*it is only in respect of the freedom of creating and using parodies where there may be truly a need for legislative clarification but that the new provision of the Bill on parody would have been sufficient to address and settle the issue. It goes without saying that the author's position is the same in respect of the acquis; in view of Article 5(3)(k) of the Information Society (Copyright) Directive on an exception for the purpose of caricature, parody or pastiche it is quite doubtful that a specific "UGC exception" might be necessary and justified*".

In our view, there are already important exceptions in the Directive which could be useful for UGC purposes; we mentioned them before (parody, quotation, incidental inclusion). If such exceptions were better harmonized and made compulsory throughout the Union, there would in our view be no need for a specific UGC exception which, as Ficsor illustrated, may also raise questions regarding its compatibility

<sup>1664</sup> <http://www.playwrightsguild.ca/news/writers-rights-coalition-bill-c-32-brief>

<sup>1665</sup> <http://balancedcopyright.gc.ca/eic/site/crp-prda.nsf/eng/rp01186.html>

<sup>1666</sup> Pages 28 and 29.

<sup>1667</sup> Sam Ricketson, Jane Ginsburg, *International Copyright and Neighboring Rights*, Oxford University Press, 2005, p. 483-484.

<sup>1668</sup> Dr. Mihály Ficsor, "Comments on the UGC provisions in the Canadian Bill C-32: potential dangers for unintended consequences in the light of the international norms on copyright and related rights", October 23, 2010, available at [http://www.copyrightseesaw.net/archive/?sw\\_10\\_item=31](http://www.copyrightseesaw.net/archive/?sw_10_item=31)

<sup>1669</sup> Ficsor further explains that his paper was prepared in October 2010 in the middle of the debates on Bill C-32 to amend the Canadian Copyright Act, that at that time, it was not published, but "*the reason for its present publication is that recently **certain documents of the European Commission have raised the idea of a possible amendment to the acquis with the purpose of facilitating the creation and use of adaptations of works protected by copyright in the form of "user generated content" (UGC), and the new Canadian legislation (the amendments have been adopted in the meantime) has been referred to as a possible model. The paper may be useful to point out to what kinds of unintended negative consequences - and potential problems with certain international norms - the Canadian model might lead***" (emphasis added).

with the three-step test, due i.a. to a lack of a sound legal-political reason justifying a “special case” under such three-step test<sup>1670</sup>. The authors of this report also agree with Ficsor when he states that “*the mere reason that a derivative work is created and made available and that therefore it should be free in order to guarantee the freedom of expression is hardly an acceptable reason alone since Article 12 and 14(1) of the Berne Convention provide for an exclusive right of adaptation which “by definition” covers the creation of derivative works*”<sup>1671</sup>.

The lack of evidence of any real chilling effect of the existing legal framework – at least as far as we could identify it – renders it unnecessary to provide for a new sweeping UGC exception. A solution based upon the existing exceptions should prove sufficient to guarantee both a sufficient protection of the authors and sufficient freedom for the users.

### **Advantage(s)**

There are clear advantages to a specific UGC exception, particularly from the point of view of users: a specific exception normally brings more clarity and transparency to users. However, we think that, for a specific exception to be adopted, there must be sufficient reasons and factual evidence that there is a need for such new exception. At this stage, it is not our view that this is the case. The quasi-inexistence of any case-law and the growing use and putting into place of voluntary arrangements (monetization agreements, micro-licences, etc.) do not plead in favour of a specific exception. The Canadian precedent is too recent to assess the benefits and drawbacks of their UGC exception.

### **Disadvantage(s)**

It is difficult to find substantial factual and policy considerations that would justify an explicit UGC exception; it is also difficult to see how a UGC specific exception could be made sufficiently clear and compatible with international provisions like the three-step test. A new text would unavoidably create new uncertainties regarding its scope, conditions of application, etc.

## **D. Adopting a new and “horizontal” exception or a fair-use or “fair-use like” kind of exception**

Even if they are both based on the same international copyright instruments, the Anglo-American copyright system and the European *droit d’auteur* regime differ significantly on the question of copyright limitations. Continental European countries provide for a closed catalogue of carefully-defined limitations, whereas the American tradition allows for an open-ended fair use system that provides generic criteria left to the appreciation of the courts (to determine individual cases of exempted unauthorized uses). The British tradition of *fair dealing*, also applicable in other states of the Commonwealth, is sometimes assimilated to fair use. It is arguably closer to the European system, because the purposes eligible for exemption are exhaustively listed by law whereas a similar list provided by the *fair use* doctrine is only indicative.

Under the American fair use system, the use of a copyrighted work is permissible if it is made for purposes such as (without this list being limitative) criticism, comment, news reporting, teaching, scholarship or research, and where the evaluation of four criteria strikes in favour of the user : (1) the purpose and character of the use, including whether such use is of a commercial nature or is for non-profit educational purposes; (2) the nature of the copyrighted work; (3) the amount and substantiality of the portion used in relation to the copyrighted work as a whole, and (4) the effect of the use upon the potential market for or value of the copyrighted work. The evaluation of these factors is an open-ended

---

<sup>1670</sup> See article by Ficsor, p. 13.

<sup>1671</sup> M. Ficsor, op. cit., p. 13.

and context-sensitive inquiry; they all must be explored, and the results weighed together, in light of the purposes of copyright, i.e. 'Promoting the Progress of Science and Useful Arts'.

In the Copyright Directive, the European Union has made the choice to set out a closed list of optional exceptions, the application of which must further comply with the three-step test.

In a nutshell, an open-ended system like fair use tends to be more evolutionary, as it allows for more and new limitations to emerge along with technical evolutions and new socially accepted uses of the works. By contrast, a system of narrowly defined exceptions tends to favour legal security and it makes it easier to figure out which uses of a copyrighted work are allowed without the authorization of the author and which are not.

Authors have criticized the system adopted in the EU system, claiming that it combines the downsides of both legal traditions without the advantages thereof<sup>1672</sup>. According to them, the current system lacks flexibility, as it limits the freedom of Member States to adopt exceptions to a closed list. It also lacks legal security for potential beneficiaries of the exceptions because national implementations thereof may still be challenged on the basis of an open-ended norm, the three-step test.

The *Gowers Review*<sup>1673</sup> has expressed the view that the current system is marked by “a lack of flexibility to accommodate certain uses of protected material that a large proportion of the population regards as legitimate and which do not damage the interests of rights holders”<sup>1674</sup> and has recommended “that Directive 2001/29/EC be amended to allow for an exception for creative, transformative or derivative works, within the parameters of the Berne Three-Step Test”<sup>1675</sup>. The Hargreaves report<sup>1676</sup> came up to the conclusion that “the lack of progress in achieving an adaptive copyright framework will impose mounting costs” and has recommended exploring, at the EU level, “a new mechanism in copyright law to create a built-in adaptability to future technology” (which covers mainly other more technological developments than just UGC, which is not really a “technological development” as such).

It is however worth mentioning that authors have underlined the possibilities to find more flexibility in the copyright regime at the national level rather than at the core EU-level. They argue that the system of exceptions set out by the current legal framework (article 5 of the directive) offers room for flexibilities which is not used by Member States at its full potential. Firstly, not all exceptions are implemented by all Member States. The Hargreaves report of 2011, for instance, has pressed the British Government to “realise all the opportunities within the EU framework” by implementing exceptions for format shifting, parody, non-commercial research and library archiving<sup>1677</sup>. Secondly, because the concerned provisions of the Directive are in many cases categorically worded prototypes rather than precisely circumscribed exceptions. In various cases, Member States have opted for more narrowly circumscribed wording of said exceptions in their national implementations, which tends to rigidify the system. Instead, they may choose to transpose the literal, broad wording of the EU exceptions into their national laws, in combination with the three-step test. In this sense, it has been suggested that several limitations set out by the Directive could be combined, at the national level, in a semi-open provision like the following: “it does not constitute an infringement to use a work or other subject-matter for non-commercial scientific research or illustrations for teaching, for the reporting of current events, for criticism or review of material that has

---

<sup>1672</sup> M. Senftleben, “Bridging the differences between copyright’s legal traditions – the emerging fair EC fair use doctrine”, available on [www.ssrn.com](http://www.ssrn.com)

<sup>1673</sup> A. Gowers, “Gowers Review on Intellectual Property”, December 2006, available on <http://www.official-documents.gov.uk/document/other/0118404830/0118404830.pdf>

<sup>1674</sup> Page 39.

<sup>1675</sup> Recommendation 11, Page 68.

<sup>1676</sup> I. Hargreaves, “Digital Opportunity. A review of Intellectual Property and Growth”, 2011, available on <http://www.ipo.gov.uk/>, pages 47 and 52.

<sup>1677</sup> I. Hargreaves, p. 51.



*already been lawfully made available to the public, or quotations from such material serving comparable purposes, for caricature, parody or pastiche, or the incidental inclusion in other material, provided that such use does not conflict with a normal exploitation of the work or other subject-matter and does not unreasonably prejudice the legitimate interests of the rightholder*<sup>1678</sup>.

At the European level, a complete switch from the current European system of legally defined exceptions to an open-ended, fair-use like regime, does not receive much support from academics and stakeholders<sup>1679</sup>. First, because it makes little sense to completely abandon a legal tradition that has existed from hundreds of years, to adopt a system that is not familiar at all to European lawyers. Then, because it would imply the creation of legal uncertainty at a large scale, which is highly unwelcome. Legal uncertainty in the US fair use system is mitigated by more than two hundreds of years of binding case-law, which provides thousands of examples of application of the fair use criteria in particular cases. The adoption, from scratch, of a similar system in the EU would lack this fundamental element and leave practitioners and courts in great uncertainty when it comes to predict the application of, and to apply such a norm to individual cases. We follow the views expressed by Ian Hargreaves in his 2011 review that promoting a Fair Use Copyright exception in the EU is not the best solution, because the economic benefits of a more adaptative copyright regime are more likely to be attained in practice otherwise and because there are genuine legal doubts about the viability of a US case law based legal mechanism in a European context.

One may think of combining both worlds by keeping the (closed) list of exceptions and supplementing it with a flexible, “fair-use like” provision. Such exception would be applicable to uses which are not covered by listed exceptions, but for which good reasons exist to place them outside of the control of the copyright holder. It is however far from certain that such system would comply with the international three-step test set out, i.a., by the Berne Convention and the WIPO treaties. Risks also exist that such provision causes legal uncertainty, possibly increased litigation. Furthermore, it would not fit easily in many Member States traditions and legal background regarding copyright law.

Authors have expressed doubts about the compatibility of a specific UGC exception with the three-step test<sup>1680</sup>; the same reasoning may apply, so we think, to a residual “fair-use”-like provision. In these authors’ opinion, most UGC eligible for protection would already be covered by existing exceptions (mostly quotation and parody), so that it is very hard to identify which other UGC works, not covered by existing exceptions, would fall under a new UGC exception if this exception has to qualify as applying only to “special cases” as required by the first step of the test<sup>1681</sup>.

A slight variant of this option, more interesting in our opinion, would be the opening of the current list of exception to “similar cases”. This solution is promoted in article 5.5 of the “Wittem Code”, a model European Copyright Code drafted by several academics<sup>1682</sup>. The authors justify this solution as follows: *“On the one hand, the extension to similar uses provides the system with a flexibility which is indispensable in view of the fact that it is impossible to foresee all the situations in which a limitation could be justified. On the other hand, the possibility of flexibility is narrowed down in two ways. Firstly, the extension applies to uses ‘similar’ to the ones expressly enumerated. Thus, a certain normative effect is bestowed on these examples: the courts can only permit uses not expressly enumerated insofar as a certain analogy can be established with uses that are mentioned by the Code. Secondly, such similar uses may not conflict with the normal exploitation of the work and not unreasonably prejudice the*

---

<sup>1678</sup> B. Hugenholtz and M. Senftleben, “Fair Use in Europe. In search of flexibilities”, 2011, available on <http://ssrn.com> , p. 17.

<sup>1679</sup> I. Hargreaves, p.44.

<sup>1680</sup> M. Fisor, “Comments on the UGC provisions in the Canadian Bill C-32: potential dangers for unintended consequences in the light of the international norms on copyright and related rights”, 2010, available on <http://www.copyrightseesaw.net/>

<sup>1681</sup> For a similar opinion about open-ended exceptions in general, see A. Lucas, « Pour une interprétation raisonnable du triple test, ou pourquoi il faut éviter d’ajouter le flou au flou », *A&M*, 2009, p. 227

<sup>1682</sup> Available on <http://www.copyrightcode.eu/>

*legitimate interests of the author or rightholder, taking account of the legitimate interests of third parties*<sup>1683</sup>. Arguably, this solution is more likely to comply with the first step of the three-step test, as cases “similar” to those explicitly listed in the directive may still be considered as “special” cases ; authors have however expressed doubts in this regard<sup>1684</sup>. The two other steps of the test are expressly implemented as conditions to benefit from the “analogous” exceptions and must therefore be investigated in every particular case.

Another academic initiative pursuing similar objectives is the “Declaration on the three-step test” signed by a number of European scholars (who some consider as “predominantly pro-user”)<sup>1685</sup>. The authors propose an interpretation of the test under which existing exceptions and limitations within domestic law are not unduly restricted and the introduction of appropriately balanced exceptions and limitations is not precluded. Amongst other principles stated in this declaration, its authors express the view that the three steps are to be considered together and as a whole in a comprehensive overall assessment, that the test does not require exceptions to be interpreted narrowly and that the first step of the test does not prevent the application of existing statutory exceptions to similar factual circumstances. Whereas such approach is disputed by certain authors<sup>1686</sup>, others find the idea “charming” to turn the three-step test into a positive reading to some extent<sup>1687</sup>. They support the idea that the test could also be used to extend existing exceptions and create new ones, and not only to narrow down the scope of existing exceptions.

### **Advantage(s)**

The different options examined above pursue the same objective: creating more flexibility in the European system of exceptions. The current exhaustive list of optional exceptions, narrowed down by the three-step test as drafted in the Directive, is considered too rigid by a number of commentators.

The main advantage of modifying the current legal framework in a more flexible direction is the enhancement of adaptability of copyright law. A more flexible system would allow the exceptions to evolve according to technological changes, to social needs, to new socially accepted uses of copyrighted works or to changes in the acceptability of certain uses, and to the moving impact of certain uses on the authors’ interests.

Arguably, many UGC would fall within the scope of one or the other exception if one was to apply a flexible system of exceptions based on an analogical approach of existing limitations, framed by the conditions of the three-step test to avoid harming the author’s interests.

Also, a more flexible system may evolve over time, to cover new practices and uses of copyrighted works - as long as they do not deprive authors from potential markets and do not harm their legitimate interests.

### **Disadvantage(s)**

More flexibility in the system of exceptions entails less legal certainty to some extent. Open norms, depending on generic conditions, are also less predictable in their actual application. Users or businesses willing to justify certain (new) uses of copyrighted works on the basis of open norms will probably have to take the risk of being ultimately found liable for copyright infringement if legal proceedings go wrong.

---

<sup>1683</sup> Commentary under Chapter 5 of the Wittem Code.

<sup>1684</sup> J. Ginsburg, « European Copyright Code – Back to First Principles (with some additional detail), 2011, available on <http://ssrn.com>, pp. 26-27.

<sup>1685</sup> X., « Declaration – A Balanced Interpretation of the ‘Three-Step Test’ in Copyright Law », Jipitec, 2010, p. 119.

<sup>1686</sup> A. Lucas, « Pour une interprétation raisonnable du triple test, ou pourquoi il faut éviter d’ajouter le flou au flou », *A&M*, 2009, p. 227

<sup>1687</sup> R. Hilty, « Declaration on the ‘three-step test’, where do we go from here », Jipitec, 2010, p. 83, who is one of the signatories of said declaration.

This risk of increased legal uncertainty goes along with a risk of multiplication of legal proceedings, because Courts will be responsible for applying flexible norms in particular cases. Arguably, the number of legal proceedings concerning the exceptions will increase with the adoption of a more flexible provision on this matter, at least until the amount of case-law is sufficient to draw clear guidelines for their application.

A switch from the EU system of legally defined exceptions to an open, fair-use like system is thus, in our opinion, not desirable, because of the huge legal uncertainty that it would unavoidably create. It would also most probably be detrimental for the functioning of the Internal Market (as a result of the difficulty to ensure a proper cross-border effect to exceptions that have not been substantially harmonised).

On a more practical point of view, one must not underestimate that any attempt to introduce flexibility within the system of copyright exceptions would, for the time being at least, be *politically* very hard, if not impossible to materialise at an EU level and will attract much opposition.

It is also not currently proven that *all* exceptions existing in the current list need more flexibility. In the frame of the current Study, which is limited to UGC, we support the idea that more flexibility in the application of certain exceptions (mostly quotation, parody and incidental inclusion) would help securing the legal dissemination of UGC. It does not necessarily mean, however, that a general provision broadening the scope of all exceptions to analogous cases is needed or even desirable in any cases. The impact of such a provision should certainly receive careful assessment. For the needs of this Study, we consider that a horizontal provision bringing more flexibility to all exceptions goes beyond what is needed for securing the legal status of UGC.

A more flexible system may also have a negative impact on harmonization, if open norms or criteria receive different interpretations by the Courts across the Member States. Ultimately, the CJEU would bear the responsibility to unify these interpretations but it will likely take many years and cases to achieve this objective. Also, the CJEU may be snowed under with a large number of cases concerning the application of open principles to very particular cases, which is arguably not its intended role.

The equitable compensation foreseen in favour of the authors by certain exceptions may be significantly more complicated to apply in a system where analogous application of the exceptions is allowed. Firstly, certain cases may be similar to more than one exception, which do not set out the same mechanisms of compensations (if any). Then, compensation that is justified for a specific case covered by an existing exception may not be justified for different, but somehow similar cases. On the opposite, it may be justified to allow compensation to the authors in cases which are similar to those covered by exceptions where no compensation is foreseen. It would be important to fix this issue, because a system where courts may decide to allow or deny compensation and to set the amount thereof on a case by case basis would be highly impracticable. By comparison, fair use, US-style is an "all-or-nothing" system. Either there is infringement or not, and there is no middle ground of compensation. In a mixed system like the InfoSoc Directive, in which some uses are unpaid and others require compensation, one must be careful that opening up the unpaid uses may have undesirable repercussions on the system of compensated uses. Asking for more flexibility without assessing the impact on the compensated uses should not be at the risk of potentially violating the 3d step of the 3-step test.

**To sum up**, the adoption of a flexible, horizontal exception or of a provision which would introduce some kind of flexibility to the exceptions within the list seems attractive, but may ultimately give rise to more questions than it will provide answers. It will be politically hard to adopt, practically hard to apply and, arguably, give rise to more litigation. It will affect the application of exceptions far beyond the limited domain of UGC on internet and its effects should be carefully assessed. We consider therefore this solution as not proportionate, in the frame of this Study, for clarifying the legal status of UGC. We do support, however, the idea that at least certain exceptions (essentially the three exceptions that we have examined throughout this report) should be applied with more flexibility if the need to secure the creation and dissemination of UGC was established. More precisely, we support the trend observed in the recent case-law which mentions the effective application of the exceptions and the balance of interests that

should be made between the interests of the right holders and those of the beneficiaries of the exceptions, especially where their fundamental rights (like freedom of expression) are at stake.

### **E. Dealing with UGC via the e-Commerce Directive**

Finally, another option which the Commission might want to consider is to deal with UGC, and more particularly with the often mentioned “chilling effect” of the legal regime on UGC (if such chilling effect exists – which we could not find much substantiated evidence about; see the first part of our report), could be to deal with that concern in the context not of a review of the Information Society Directive but of the announced review of the e-Commerce Directive<sup>1688</sup>.

A possible abusive use of notice-and-take down procedures is one of the issues mentioned in the context of the reassessment of the e-commerce directive, with a public consultation being launched on how notice-and-take-down procedures are applied and should be improved, i.a. to guarantee more respect for the rules of due process and the right to be heard<sup>1689</sup>. It is worth mentioning that, in this context, the “notice and take down” procedures are one of the topics of the Consultation launched by the Commission. The summary of the results of this Consultation indicates that rightholders complained about the trend towards the “monetization” of NTD (notice and take down) procedures, “which could be characterized as the development of a “notice-and-revenue-share” procedure”<sup>1690</sup>.

As the revision of the e-Commerce Directive is out of scope of our Study, we shall not explore this route much further but there would be room for action in that sector, should it be decided not to amend the Copyright Directive.

#### **Advantage(s)**

One advantage is that a modification of the NTD procedures to allow a right of reaction by the uploader before some content is taken down should bring down the number of abusive uses of such NTD procedures (yet, as already said, we have not seen really convincing figures, at least as regards NTD demands based on alleged copyright infringements), without having to introduce any new exception to the Copyright Directive. It may thereby avoid to open the Pandora's box of exceptions.

#### **Disadvantage(s)**

It is uncertain, as some have already stated, that users whose UGC content is being removed will insist and ask that it be put back. Most users might prefer to refrain from doing so and avoid the risk of a legal action. This disadvantage has however mostly been put forward in the US, where users face – at least in theory - the risk of high (punitive) damages in such legal actions, which is not the case in Europe. More importantly, as the e-Commerce Directive adopts a horizontal approach, does not aim at harmonizing any copyright rules and is based on (exemptions of) liability principles, the divergences observed in the Member States' legislations on the exceptions which are relevant for UGC would continue to exist, with all consequences attached thereto.

---

1689 See the Commission's document: Ensure the transparency, effectiveness, proportionality and fundamental rights compliance of notice-and-action procedures (cf [http://ec.europa.eu/governance/impact/planned\\_ia/docs/2012\\_markt\\_007\\_notice\\_and\\_takedown\\_procedures\\_en.pdf](http://ec.europa.eu/governance/impact/planned_ia/docs/2012_markt_007_notice_and_takedown_procedures_en.pdf))

1690 See the Summary of the results of the Public Consultation by the Commission on the future of electronic commerce in the Internal Market and the implementation of the Directive on electronic commerce (2000/31/EC), p. 12.

## IV. Conclusions

As **preliminary conclusions to the first part of our Report**, we had made the following observations:

UGC has grown exponentially in the last few years. A major part of UGC which may be found on the internet requires in principle a prior licence from the rightholders (whether it be for the reproduction right, the adaptation right or the right of making available). The exceptions which exist presently in copyright law and can be relevant (parody, quotation, incidental use) could only be invoked for a relatively small number of UGC materials; and the legal arguments which could be found outside of copyright would provide relief in an even smaller number of UGC cases. Some said that the European legal framework “leaves a lot of uncertainties for the parties concerned”<sup>1691</sup>; on the other hand, when analyzing concrete UGC cases and wondering whether there is a potential copyright infringement, there are, in our opinion, much more instances where the answer may clearly be “yes” than cases where the answer will be “no” or will be uncertain.

Yet, there is very little (if any) case-law and apparently not much opposition from rightholders. It proved very hard to find cases, as the Commission had asked us to investigate, where UGC should have been accepted by courts while it has not been, or even cases where UGC cases were rightfully rejected.

The obvious lack of opposition (at least via court proceedings) by rightholders may have various reasons: they may consider that such use does not cause them any noticeable harm (at least, not of such importance to justify court proceedings), or that it increases their reputation and public exposure<sup>1692</sup>. Also, the lack of opposition may be explained by the fact that, in many cases, a monetization agreement has been concluded between the rightholder and the platform. It seems that rightholders adopt a sort of “wait & see” approach or generally do not mind the UGC uses.

As **conclusions to this second part of our Report**, we will make the following observations:

We distinguished between the actions which could take place within the current legal framework, i.e. without making any changes to the existing texts and to the Directive and the actions which would involve changes to the existing legislation and/or to the Directive.

We first examined the possible actions which the Commission could take without changing the legislative framework. While “not taking action” was not considered a desirable option, it is already outdated anyway since the Commission launched its “Licences for Europe” initiative which will extend throughout 2013. It is premature to say if such initiative will prove fruitful but it was certainly a first, if not last, necessary step to take, i.e. to try to collect factual information and gather stakeholders’ positions on UGC. If this series of meetings ends up in initiatives which increase users’ understanding and knowledge of the applicable rules on UGC or which are turned into an MoU between stakeholders<sup>1693</sup> on best practices in the UGC sector, it will have proven useful as such.

We consider that it would be useful to have a Commission’s Communication on UGC, in which the Commission would give its own views as to what UGC uses are allowed or not, and would give its own interpretation of the relevance (or not) of the existing exceptions for UGC. Even though not binding, such Communication would help in increasing users’ understanding of the rules of the game and provide useful (even if not binding) guidance to practitioners and judges. However, such Communication could not, as such, provide a solution to the not harmonised situation regarding exceptions in the Member States.

---

<sup>1691</sup> IDATE, TNO & IVIR, User-Created-Content: Supporting a participative Information Society, SMART, 2007/2008, p. 27 to 174. See also the OECD Report, OECD, DSTI/ICCP/IE (2006)7/Final, Working Party on the Information Economy, Participative Web: User Created Content, 12 April 2007, p. 183.

<sup>1692</sup> See in this sense the recent report on parody commission by the IPO; cf. supra.

<sup>1693</sup> Let us insist that UGC cases almost always involve three actors : the rightholder, the user and the platform. This triangular relationship should always be remembered when discussing UGC issues.

Similarly, encouraging education and information initiatives aimed (mainly) at users would also be useful but would neither be sufficient, given the uncertain and not harmonised situation amongst the Member States, which entails that the messages to be passed on to the users may be hard to draft in a clear manner and thus hard to understand by their recipients.

We then examined the legislative initiatives which the Commission could take (always in the instance that the chilling effect to UGC of the current legal framework was established).

We come to the conclusion that **the most proportionate manner** to deal with UGC, to increase clarity and ensure that copyright is rightfully invoked for what it is meant, would be to suggest amendments to the Copyright Directive by:

- Further harmonizing the exceptions which are relevant for UGC, being quotation (article 5.d), incidental inclusion of a work or other subject-matter in other material (article 5.i) and use for the purpose of caricature, parody or pastiche (article 5.k), since the interpretation to be given to these articles has proved uncertain, and relatively slight adaptations to these exceptions might prove sufficient to deal with the UGC cases which are the most worthy of attention;
- Making these exceptions (meant to benefit users, not commercial platforms) compulsory for Member States and making two of them (quotation and parody) (at least to some extent) unwaivable by contract (subject to this being compatible with moral rights) to ensure that they reach their intended purpose<sup>1694</sup> and that users are confronted with the same rules throughout the Union.
- Ensuring that the beneficiaries of the exception are only the UGC creators and not commercial platforms (which needs further thinking including in relation of the application of the e-commerce Directive)

Another, more horizontal, approach could be to add to the closed list of exceptions a provision which would introduce some kind of flexibility to the list itself or to the exceptions within the list. Such initiative may seem attractive and, from a theoretical point of view, may seem justified to ensure that copyright keeps pace with the evolving technological context and social uses. However, one may expect that such attempt to introduce flexibility within the system of copyright exceptions would, for the time being at least, be *politically* impossible to materialise at an EU level<sup>1695</sup> and will attract much opposition from many sides; secondly, one may fear that, regardless of the efforts put in the wording of such provision, the “flexibility” objective will *practically* give rise to more questions than it will answer and will lead to increased litigation (i.a. on its compatibility with the three-step test). Furthermore, its impact would obviously go way beyond the UGC sector and it may well be that, in some sectors, it leads to unexpected but undesired results – a concern which we could not examine within the limits of this UGC related report. Finally, as indicated, it is an unfamiliar concept for copyright in most Member States and it is likely that it would have an adverse impact on the functioning of the Internal Market

Our opinion on a “horizontal exception” or on the idea of introducing more flexibility in the list of exceptions should however not be understood as meaning that judges should, in our view, refrain from

---

<sup>1694</sup> Exceptions to copyright must, according to the EUCJ, be interpreted in order to achieve their intended purpose. See Premier League case, par. 163 : “None the less, the interpretation of those conditions must enable the effectiveness of the exception thereby established to be safeguarded and permit observance of the exception’s purpose as resulting in particular from recital 31 in the preamble to the Copyright Directive and from Common Position (EC) No 48/2000 adopted by the Council on 28 September 2000 with a view to adopting that directive (OJ 2000 C 344, p. 1)”.

<sup>1695</sup> This is thus without prejudice to initiatives which Member States might decide to take, at their own national level, to introduce more flexibility in the list of exceptions. Such trend may i.a. clearly be observed in The Netherlands: the Minister of Economy has presented in November 2012 a study entitled “Flexible Copyright” to make the system of exceptions more flexible. The Ministry of Justice and Security and presented to the Parliament the recommendations of the Dutch Copyright Commission on UGC, which suggests to include UGC within the scope of the quotation exception.

the growing tendency of operating a “balance of interests” when dealing with a dispute involving a copyright exception (when such dispute leaves room for interpretation); this tendency is, in our opinion, a manner by which copyright will in the long run maintain its legitimacy, in a world when such legitimacy is more often questioned than in the past.

Instead of a horizontal approach, one could think of introducing a UGC specific exception. As we indicated, there does not seem to be sufficient problems in practice to justify such new exceptions. Many mechanisms have already been put in place to authorize UGC uses (even if some scrutiny may be justified, on a case-by-case basis, to verify that they are balanced in regard of all parties’ rights and legitimate interests). A UGC exception remains in our view a premature option.

Lastly, an alternative route could be to work alongside the review of the e-Commerce Directive and the improvement of the notice-and-take down procedures.

**To sum up:** a further harmonization of the existing exceptions which are relevant for UGC would be desirable if the need to act is established. From an (very incomplete) market analysis and from looking at the (very little caselaw), it does not seem that the need is really pressing. On the other hand, for the good faith user who wishes to engage in creating UGC works while fully respecting all legislations, the game may be hard to play<sup>1696</sup>. In the meantime, and because one may expect that quite some time may be needed before such harmonization actually reaches the national legislations, an interpretative document by the Commission on the interpretation which the Commission thinks should be given to these exceptions would be useful. As an alternative to such further harmonization in the Copyright Directive, an improvement of the notice-and-take down procedures in the e-Commerce Directive would only be a second-best option. In parallel, if the (still shy) signal given by the EUCJ to interpret exceptions in a way which ensures their effectiveness is being confirmed, together with the trend of courts to operate a “balance of interests”, the outcry about an unbalanced evolution of copyright would certainly diminish.

---

<sup>1696</sup> For the EU legislator, the question is thus whether this is worth suggesting a change to the Directive. It is more a political than a legal question, we would suggest.

## Bibliography

### Scholarly literature

AUFDERHEIDE, P. & JASZI, P., "Untold stories: creative consequences of the rights clearance culture for documentary filmmakers", Center for Social Media, 2004, available at [http://www.centerforsocialmedia.org/files/pdf/UNTOLDSTORIES\\_Report.pdf](http://www.centerforsocialmedia.org/files/pdf/UNTOLDSTORIES_Report.pdf).

BIRD, R.C. & PONTE, L.M., "Protecting moral rights in the United States and the United Kingdom: Challenges and opportunities under the U.K.'s new performances regulations", *Boston University International Law Journal*, vol. 24:213, 2006, 213-282, available at <https://www.bu.edu/law/central/jd/organizations/journals/international/volume24n2/documents/213-282.pdf>.

BRAVERMAN, A.N., & SOUTHWICK, T., "The User-Generated Content Principles: The Motivation, Process, Results and Lessons Learned", *Colum. J. L. & the Arts* 2009 (32) 471.

CARON, C., "Abuse of Rights and Author's Rights", 176, *RIDA* 1998, 2, 4.

DAHAN, V. & CH. BOUFFIER, CH., "Arrêt Painer du 1er décembre 2011 : la CJUE poursuit son oeuvre d'harmonisation du droit d'auteur", *Revue Lamy Droit de l'immatériel*, March 2012, n° 80.

DUSOLLIER, S., "The relations between copyright law and consumers' rights from a European perspective", *European Parliament Publication*, 2010 39 p., available at SSRN: <http://ssrn.com/abstract=2127736>.

EDWARDS, L., "Role and responsibility of Internet intermediaries in the field of copyright and related rights", Report for WIPO, available at [http://www.wipo.int/copyright/en/doc/role\\_and\\_responsibility\\_of\\_the\\_internet\\_intermediaries\\_final.pdf](http://www.wipo.int/copyright/en/doc/role_and_responsibility_of_the_internet_intermediaries_final.pdf)

ELKIN-KOREN, N., "User-Generated Platforms", in DREYFUSS, R.C., ZIMMERMAN, DIANE L. & FIRST, H. (ed), *Working within the Boundaries of Intellectual Property Rights*, Oxford University Press, 2010, 584.

ERICKSON, K., *Evaluating the Impact of Parody on the Exploitation of Copyright Works: an Empirical Study of Music Video Content on YouTube*, Independent report commissioned by the Intellectual Property Office, Study 1, January 2013, 48 p., available at <http://www.ipo.gov.uk/ipresearch-parody-report1-150313.pdf>.

FICSOR, M., "Comments on the UGC provisions in the Canadian Bill C-32: potential dangers for unintended consequences in the light of the international norms on copyright and related rights", *Copyright see-saw*, 23 October 2010, 19 p., available at [http://www.copyrightseesaw.net/archive/?sw\\_10\\_item=31](http://www.copyrightseesaw.net/archive/?sw_10_item=31).

GEIGER, C. et alii, "Declaration – A Balanced Interpretation of the 'Three-Step Test' in Copyright Law", *Jipitec*, 2010, p. 119-122.

GEORGE, C. & SCERRI, J., "Web 2.0. and User-Generated Content: legal challenges in the new frontier", *Journal of Information, Law and Technology*, 2007, 20 p., available at [http://www2.warwick.ac.uk/fac/soc/law/elj/jilt/2007\\_2/george\\_scerri/george\\_scerri.pdf](http://www2.warwick.ac.uk/fac/soc/law/elj/jilt/2007_2/george_scerri/george_scerri.pdf).

GERVAIS, D., "The Tangled Web of UGC: Making Copyright Sense of User-Generated Content", *Vanderbilt J. Of Entertainment And Tech. Law*, 2009, 841-870, available at <http://www.jetlaw.org/wp-content/journal-pdfs/Gervais.pdf>.



GINSBURG, J.C., "Separating the Sony Sheep from the Grokster Goats: Reckoning the Future Business Plans of Copyright-Dependent Technology Entrepreneurs", *Ariz. L. Rev.*2008 (50), 576-609, available at <http://www.arizonalawreview.org/pdf/50-2/50arizrev577.pdf>.

GINSBURG, J.C. "European Copyright Code – Back to First Principles (with some additional detail)" *AM* 2011, Columbia Public Law Research Paper No. 11-261, 28 p., available at SSRN: <http://ssrn.com/abstract=1747148>.

GUIBAULT, L., *Copyright Limitations and Contracts: An Analysis of the Contractual Overridability of Limitations on Copyright*, Kluwer 2002, 392 p.

HETCHER S., "User-Generated Confusion: the Legal and Business Implications of Web 2.0", 10 *Vanderbilt J. Of Entertainment And Tech. Law* 2009, 863-892., available at [http://www.jetlaw.org/wp-content/journal-pdfs/Hetcher\\_FINAL.pdf](http://www.jetlaw.org/wp-content/journal-pdfs/Hetcher_FINAL.pdf).

HILTY, R., "Declaration on the 'three-step test', where do we go from here", *Jipitec* 2010, p. 83-86.

HILTY, R. & NÉRISSON, S., "Overview of National Reports About 'Balancing Copyright'" (March 1, 2012), in HILTY, R. & NÉRISSON, S., *Balancing Copyright - A Survey of National Approaches*, Springer, 2012; Max Planck Institute for Intellectual Property & Competition Law Research Paper No. 12-05, available at SSRN: <http://ssrn.com/abstract=2040607>.

HUGENHOLTZ, P.B., "Copyright and freedom of expression in Europe", in ELKIN-KOREN, N. & NETANEL, N.W. (eds), *The Commodification of Information*, Kluwer International, 2002, 528.

HUGENHOLTZ P.B. & SENFTLEBEN, M.R.F., "Fair Use in Europe. In Search of Flexibilities, Amsterdam", November 2011, available at <http://ssrn.com/abstract=1959554> or <http://dx.doi.org/10.2139/ssrn.1959554>, 30 p.

HUGENHOLTZ, P. B., "Codes of Conduct and Copyright Enforcement in Cyberspace" (March 7, 2012) in STAMATOUDI, I.A. (ed), *Copyright Enforcement And The Internet*, Kluwer Law International, Information Law Series Vol. 21., 2010 pp. 303-320; Amsterdam Law School Research Paper No. 2012-41; Institute for Information Law Research Paper No. 2012-35, available at <http://ssrn.com/abstract=2017581>.

JANSSENS, M.C., "Article 22" in Brison, F. & Vanhees, H. (ed), *La loi belge sur le droit d'auteur, Commentaire par article, Hommage à Jan Corbet*, Larcier, 2012 , 708.

LEE, E., "Warming up to User-Generated Content", *University of Illinois Law Review*, Vol. 2008, No. 5, 2008, available at [http://papers.ssrn.com/sol3/papers.cfm?abstract\\_id=1116671](http://papers.ssrn.com/sol3/papers.cfm?abstract_id=1116671).

LINDNER, B. & SHAPIRO, T. (ed), *Copyright in the information society – A Guide to National Implementation of the European Directive*, Edward Elgar Publishing Ltd, 2011.

LUCAS, A., "Droit d'auteur, liberté d'expression et 'droit du public à l'information' (libres propos sur deux arrêts des Cours de cassation belge et française)" in STROWEL, A., & TULKENS, F. (eds), *Droit d'auteur et liberté d'expression, Regards francophones, d'Europe et d'ailleurs*, Larcier, Brussels, 2006.

LUCAS, A., "Pour une interprétation raisonnable du triple test, ou pourquoi il faut éviter d'ajouter le flou au flou", *A&M*, 2009, p. 227.

LUCAS, A., "Actualités du droit d'auteur en France (2007/2011)", *A&M* 2012, 1, 37.

MAZZIOTTI, G., "Copyright and educational uses: the unbearable case of Italian law from a European and comparative perspective", *European University Institute*, working paper, available at [http://cadmus.eui.eu/bitstream/handle/1814/19697/LAW\\_2011\\_17\\_Mazziotti.pdf](http://cadmus.eui.eu/bitstream/handle/1814/19697/LAW_2011_17_Mazziotti.pdf).

RICKETSON, S. & GINSBURG, J.C., *International copyright and Neighboring Rights. The Berne Convention and Beyond*, Oxford University Press, 2006, 1652 p.

SAINSBURY, M., "Parody, satire, honour and reputation: The interplay between economic and moral rights", *AIPJ* 2007, p. 149-166, available at: <http://ssrn.com/abstract=1980392>.

SANDERS, A. J., "J.K. Rowling and The Lexicon: Warner Bros. Entertainment Inc. and J.K. Rowling v. RDR Books, et al.", *EIPR*, 2009, p. 45

SCHWABACH, A., "User-generated Humorous Subtitles and Copyright", *ExpressO*, 2012, 24 p., available at [http://works.bepress.com/cgi/viewcontent.cgi?article=1003&context=aaron\\_schwabach](http://works.bepress.com/cgi/viewcontent.cgi?article=1003&context=aaron_schwabach),

SENFTLEBEN, M., "Beperkingen à la carte: Waarom de Auteursrechtlijn ruimte laat voor fair use", *AMI* 2003, p.10.

SENFTLEBEN, M., "Bridging the differences between copyright's legal traditions – the emerging fair EC fair use doctrine", *Journal of the Copyright Society of the U.S.A.*, 2010, Vol. 57, No. 3, pp. 521-552, available at <http://ssrn.com/abstract=1723902>.

SENFTLEBEN, M., "Quotations, Parody and Fair Use", in HUGENHOLTZ, P.B., QUAEDVLIEG, A.A. & VISSER, D.J.G. (ed), *1912-2012: A Century Of Dutch Copyright Law*, Amstelveen: deLex 2012, 556, available at [http://papers.ssrn.com/sol3/papers.cfm?abstract\\_id=2125021](http://papers.ssrn.com/sol3/papers.cfm?abstract_id=2125021).

STROWEL, A. & TRIAILLE, J.P., *Le droit d'auteur, du logiciel au multimédia, droit belge, droit européen, droit comparé*, Kluwer/Bruylant, Brussels, 1996, 510 p.

STROWEL, A. & TULKENS, F. "Freedom of expression and copyright under civil law : of balance, adaptation and access", in GRIFFITHS, J. & SUTHERSANEN, U. (eds), *Copyright and Free Speech, Comparative and international analyses*, Oxford University Press, 2005; 476 p.

STROWEL, A. & TULKENS, F. (eds), *Droit d'auteur et liberté d'expression, Regards francophones, d'Europe et d'ailleurs*, Larcier, Brussels, 2006, 164 p.

URBAN, J.M., "Updating Fair Use for Innovators and Creators in the Digital Age: Two Targeted Reforms", Copyright Reform Act, report 1, prepared on behalf of Public Knowledge, BerkeleyLaw (University of California), Samuelson Law, Technology & Public Policy Clinic, 13 February 2010, 37 p., available at <http://www.publicknowledge.org/pdf/fair-use-report-02132010.pdf>.

WU, T., "Tolerated Use", 31 *Columbia Journal of Law & the Arts*, 2008, 31(4), 617.

XALABARDER, R., "Spanish Supreme Court rules in favour of Google search engine... and a flexible reading of copyright statutes?" *JIPITEC*, 2012, 3, 162-166, available at <http://www.jipitec.eu/issues/jipitec-3-2-2012/3445>

X. "EU Copyright Directive – a glance at exceptions & limitations – the need for revision", *BEUC* 2012, available at <http://www.beuc.eu/beucnoframe/Common/GetFile.asp?PortalSource=2530&DocID=24599&mfd=off&pdoc=1>.

## Reports and communications

*Implementing the EU Copyright Directive*, FIPR, 2004, 127 p. available at <http://www.fipr.org/copyright/guide/eucd-guide.pdf>.

*Study on the implementation and effect in Member States' laws of Directive 2001/29/EC on the harmonization of certain aspects of copyright and related rights in the information society*, Parts I & II, Institute for Information Law (IVIR), February 2007.

*User-Created-Content: Supporting a participative Information Society*, IDATE, TNO & IVIR, 2007/2008, 302 p., available at [http://www.ivir.nl/publications/helberger/User\\_created\\_content.pdf](http://www.ivir.nl/publications/helberger/User_created_content.pdf).

GOWERS, A., *Gowers Review on Intellectual Property*, 2006, 147 p. available at <http://www.official-documents.gov.uk/document/other/0118404830/0118404830.pdf>

*Participative Web: User Created Content*, OECD Report, OECD, DSTI/ICCP/IE (2006)7/Final, Working Party on the Information Economy, 12 April 2007, 74 p., available at <http://www.oecd.org/sti/38393115.pdf>.

*Defining "Noncommercial". A Study of How the Online Population Understands "Noncommercial Use"*, Creative Commons Corporation, September 2009, available at [http://wiki.creativecommons.org/Defining\\_Noncommercial](http://wiki.creativecommons.org/Defining_Noncommercial).

HARGREAVES, I., *Digital Opportunity, A review of intellectual property and growth*, 2011, 130 p., available at <http://www.ipo.gov.uk/ipreview-finalreport.pdf>.

LESCURE, P., *Culture Acte 2, Mission « Acte II de l'exception culturelle »*, *Contributions aux politiques culturelles à l'ère numérique*, May 2013, 719 p., available at <http://www.culturecommunication.gouv.fr/Actualites/Missions-et-rapports/Rapport-de-la-Mission-Acte-II-de-l-exception-culturelle-Contribution-aux-politiques-culturelles-a-l-ere-numerique>.



DE WOLF & PARTNERS

## **Press review exception for institutions and enterprises that offer press-clippings to their subscribers or employees**

By Amélie de Francquen, De Wolf & Partners, University of Namur

Under the supervision of Jean-Paul Triaille, partner, De Wolf & Partners, lecturer, University of Namur

October 2013



## Terms of reference

1. Article 5(3)(c) of the Directive provides, in its first part, for an exception for the “reproduction by the press, communication to the public or making available of published articles on current economic, political or religious topics or of broadcast works or other subject-matter of the same character, in cases where such use is not expressly reserved, and as long as the source, including the author's name, is indicated”.

The scope of this Study is focused on the so-called *press review exception*, the first part of article 5(3)(c). We were not asked by the Commission to analyse the second part of the provision, usually referred to as the *reporting of current events*, which provides for an exception for the use of works or other subject-matter in connection with the reporting of current events, to the extent justified by the informatory purpose and as long as the source, including the author's name, is indicated, unless this turns out to be impossible. In the Study, when we mention the exception, we always mean the first part of article 5(3)(c).

The Terms of reference of this Study explain that “[w]hile in principle the beneficiaries of this press review exception should be limited to “news media” such as the press or broadcasters, some Member States have adopted a wide definition of entities that constitute the “press”. For example, in the Netherlands, “any other medium serving the same purpose” can benefit from the exception. In Germany, a copyright limitation that exempts digital in-house press-clipping services has been found to be compatible with Article 5(3)(c).”

The output to provide is then described as follows:

**Output :** For the assessment of this Study, 3 cases should be examined: the offer of press clippings (1) by an organisation to its employees, (2) by a (commercial) entity to its subscribers and (3) by any legal entity or natural person to the general public. It should be examined how these practices have been assessed in the selected Member States and, for each case, whether it meets the conditions set out in art. 5(3)(c) of the InfoSoc Directive.

The object of this Study is thus mainly focused on the beneficiaries of the exception for press review.

We were not asked to analyse other provisions of the Directive that can benefit the press, such as article 5(3)(f) of the Directive for the use of political speeches and extracts of public lectures or article 5(3)(d) for quotation for purposes such as criticism or review.

### I. The exception for press review in the Information Society Directive

2. Article 5(3)(c) of the Directive provides for an exception for the reproduction by the press, communication to the public and making available rights for press review and the use of works in connection with the reporting of current events; for example, a press company which reproduces news articles on economy, politics or religion published by colleagues to inform its own readers; a broadcast organization or a web information agency, which rebroadcasts current news reports.<sup>1697</sup>

Such exception is indeed necessary to avoid copyright infringements: many acts by principle restricted under copyright are required for the press or other similar entities in order to disseminate information. In

---

<sup>1697</sup> BUYDENS, M, « La nouvelle directive du 22 mai 2001 sur l'harmonisation de certains aspects du droit d'auteur et des droits voisins dans la société de l'information: le régime des exceptions », *A&M*, 4/2001, p. 438.

principle, the prior consent of the author (or holders of rights related to copyright) should be acquired – unless an exception covers the uses.

3. The Member States are allowed to include such exception in their national laws, to the extent that the outer limits set by the Information Society Directive are not exceeded. These are expressed in art. 5(3) of the Directive :

*Exceptions and limitations*

(...)

*3. Member States may provide for exceptions or limitations to the rights provided for in Articles 2 and 3 in the following cases:*

(...)

*(c) reproduction by the press, communication to the public or making available of published articles on current economic, political or religious topics or of broadcast works or other subject-matter of the same character, in cases where such use is not expressly reserved, and as long as the source, including the author's name, is indicated, or use of works or other subject-matter in connection with the reporting of current events, to the extent justified by the informatory purpose and as long as the source, including the author's name, is indicated, unless this turns out to be impossible;*

(...)

*5. The exceptions and limitations provided for in paragraphs 1, 2, 3 and 4 shall only be applied in certain special cases which do not conflict with a normal exploitation of the work or other subject-matter and do not unreasonably prejudice the legitimate interests of the rightholder.*

This exception is optional (rec. 34 of the Directive):

*Member States should be given the option of providing for certain exceptions or limitations (...), for purposes of news reporting (...).*

4. The InfoSoc Directive did not aspire to control all modalities or conditions of the exception. As explained in the comments to the articles in the initial proposal, it was considered that the Directive should give a margin for some exceptions, such as the exception for quotations or reporting of current events: *“In view of their more limited economic importance, these limitations are deliberately not dealt with in detail in the framework of this proposal. It only sets out minimum conditions of their application, and it is for the Member State to define the detailed conditions of their use, albeit within the limits set out by these paragraphs and this Article”*<sup>1698</sup>.

## A. Origin

5. The Commission's original proposal included only eight optional exceptions;<sup>1699</sup> the exception for press review was not among them, but the exception on reporting of current events was:

*3. Member States may provide for limitations to the rights referred to in Articles 2 and 3 in the following cases:*

(...)

<sup>1698</sup> Proposal for a European Parliament and Council Directive on the harmonisation of certain aspects of copyright and related rights in the Information Society, COM(97) 628 final, Explanatory Memorandum, 10 December 1997, p. 32.

<sup>1699</sup> Proposal for a European Parliament and Council Directive on the harmonization of certain aspects of copyright and related rights in the Information Society, COM(97) 628 final, OJ, C-108, 7 April 1998, p. 6.

*(c) use of excerpts in connection with the reporting of current events, as long as the source is indicated, and to the extent justified by the informatory purpose;*

The Council included the exception for press review in article 5(3)(c) in its Common Position of 28 September 2000.<sup>1700</sup> The exception was drafted following the model of article 10*bis*(1) of the Berne Convention<sup>1701</sup> and may thus logically be interpreted in the light of this article of the Berne Convention<sup>1702</sup>.

In the Commission's amended proposal (see also Parliament's amendment 43), article 5(3)(c) had been inspired by the exception provided for in article 10*bis*(2) of the Berne Convention. The Council, however, decided to incorporate in this clause both of the exceptions provided for in article 10*bis* of the Berne Convention and to follow more closely the language used in the latter.<sup>1703</sup> In short, the first exception provided for in article 5(3)(c) regarding press review was included in the Directive following article 10*bis*(1) of the Berne Convention, while the second exception on reporting of current event follows the wording of article 10*bis*(2).

The Council did not reproduce article 10*bis*(1) of the Berne Convention literally.<sup>1704</sup> While the Berne Convention only allows reproduction and communication to the public, the Directive also allows making available. The Council did not specify, as the Berne Convention did, that the articles are published "in newspapers or periodicals". And the Directive is more restrictive than the Berne Convention regarding the indication of the source, since the mention must indicate the author's name.

The Berne Convention contained from its beginning exceptions for the press and it has always been a subject of debate.<sup>1705</sup> The first Act of 1886 provided that articles published in any country of the Union "may be reproduced in original or in translation" in the other countries of the Union "unless the authors or publishers have expressly forbidden it" (art. 7).<sup>1706</sup> It is in 1908, at the Berlin Revision Conference, that "the freedom to reproduce newspaper articles was restricted to other newspapers: it did not apply to individuals. This last restriction owed much to the advocacy of the Belgian Government which, prior to the Conference, had concerned itself with ascertaining the views of journalists and newspaper editors on the

<sup>1700</sup> Common Position (EC) n°48/2000 of 28 September 2000 adopted by the Council, acting in accordance with the procedure referred to in Article 251 of the Treaty establishing the European Community, with a view to adopting a Directive of the European Parliament and of the Council on the harmonisation of certain aspects of copyright and related rights in the information society, *OJ*, C-344, 1 December 2000, p. 18.

<sup>1701</sup> Berne Convention of 9 September 1886 for the Protection of Literary and Artistic Works, completed at Paris on 4 May 1896, amended at Berlin on 13 November 1908, completed at Berne on 20 March 1914, amended at Rome on 2 June 1928, at Brussels on 26 June 1948, at Stockholm on 14 July 1967, at Paris on 24 July 1971, and amended on 28 September 1979.

<sup>1702</sup> WALTER, M. W. & VON LEWINSKI, S. (eds), *European Copyright Law. A commentary*, Oxford University Press, U.K., 2010, p. 1047, n°11.5.55.

<sup>1703</sup> Common Position (EC) n°48/2000 of 28 September 2000 adopted by the Council, acting in accordance with the procedure referred to in Article 251 of the Treaty establishing the European Community, with a view to adopting a Directive of the European Parliament and of the Council on the harmonisation of certain aspects of copyright and related rights in the information society, *OJ*, C-344, 01 December 2000, p. 18, para. 32.

<sup>1704</sup> Article 10*bis* of the Berne Convention reads as follows: *Further Possible Free Uses of Works: 1. Of certain articles and broadcast works; 2. Of works seen or heard in connection with current events*

*(1) It shall be a matter for legislation in the countries of the Union to permit the reproduction by the press, the broadcasting or the communication to the public by wire of articles published in newspapers or periodicals on current economic, political or religious topics, and of broadcast works of the same character, in cases in which the reproduction, broadcasting or such communication thereof is not expressly reserved. Nevertheless, the source must always be clearly indicated; the legal consequences of a breach of this obligation shall be determined by the legislation of the country where protection is claimed.*

*(2) It shall also be a matter for legislation in the countries of the Union to determine the conditions under which, for the purpose of reporting current events by means of photography, cinematography, broadcasting or communication to the public by wire, literary or artistic works seen or heard in the course of the event may, to the extent justified by the informatory purpose, be reproduced and made available to the public.*

<sup>1705</sup> See RICKETSON, S., GINSBURG, J.C., *International Copyright and Neighbouring Rights. The Berne Convention and Beyond*, vol. I, Oxford University Press, New York, 2005, p. 796, n°13.47-50.

<sup>1706</sup> RICKETSON, S., GINSBURG, J.C., *International Copyright and Neighbouring Rights. The Berne Convention and Beyond*, vol. I, Oxford University Press, New York, 2005, p. 797, n°13.48.



legal regime that most readily accommodated their professional activities.<sup>1707</sup> The freedom to reproduce articles from newspaper to newspaper, except where this was expressly prohibited, was regarded as essential, particularly where small newspapers, with limited resources, were concerned.<sup>1708 1709</sup>

## B. Objective

6. The exception for press review is inspired by the promotion of the free flow of information.<sup>1710</sup> It facilitates the dissemination of news, by allowing the reproduction of articles by newspapers and periodicals under certain conditions.

For Advocate General Trstenjak, in her opinion in the Infopaq case: “the particular objective on which that exception is based is informing the public about current events; it is however also the case that this exception does not exclude the at least indirectly commercial objective (of the press) of providing information on current events.”<sup>1711</sup> A press organisation can thus also have a commercial purpose by disseminating information; its activity can also be lucrative, “at least indirectly”.

In the case Painer, she said that article 5(3)(c) seeks to strike “a balance between protection of intellectual property and freedom of the press”. That balance must therefore be taken into consideration in interpreting this provision.<sup>1712</sup>

As we already said, the source of inspiration of the exception (article 10*bis*(1) of the Berne Convention) has been subject to changes. The right balance between copyright and the press freedom has notably been searched and strongly negotiated by the delegations during the Stockholm Conference, where the previous version of article 9(2) was revised. In fact, it was proposed to delete it, because: “[i]n our day, ... it can hardly be compatible with the moral principles recognized in the press to reproduce an article published in another newspaper without having first obtained the author’s permission”<sup>1713</sup>. Besides, the press “was still free to give reports on protected works where this was required without infringing copyright – in the form of summaries – and where literal reproduction was required this was assured by an appropriately drawn right of quotation.”<sup>1714</sup> This proposal was supported by the International Federation of Journalists, but received opposition based on the promotion of the free flow of information by several delegations.<sup>1715</sup> It was argued that the exception was of particular value for isolated regions,

---

<sup>1707</sup> Authors cite: Note, in particular, the memorandum presented to the Berlin Conference by the Belgian Government: *Actes 1908*, 203-7,

<sup>1708</sup> Authors cite: *ibid.* See also the resolutions of the International Congress of the Press set out in *ibid.*, 87.

<sup>1709</sup> RICKETSON, S., GINSBURG, J.C., *International Copyright and Neighbouring Rights. The Berne Convention and Beyond*, vol. I, Oxford University Press, New York 2005, p. 797, n°13.48.

<sup>1710</sup> About the exceptions made for the benefit of the press in the Berne Convention: RICKETSON, S., GINSBURG, J.C., *International Copyright and Neighbouring Rights. The Berne Convention and Beyond*, Vol. I, Oxford University Press, New York 2005, p. 796, n°13.47. Proposal for a European Parliament and Council Directive on the harmonization of certain aspects of copyright and related rights in the Information Society, COM/97/628 final, 10 December 1997, Explanatory Memorandum, p. 32 (but at that time, the first part of art. 5(3)(c) was not yet included).

<sup>1711</sup> Opinion Advocate General Trstenjak, 12 February 2009, case C-5/08, Infopaq, para. 135.

<sup>1712</sup> Opinion Advocate General Trstenjak, 12 April 2011, case C-145/10, Painer, para. 163.

<sup>1713</sup> *Records*, 1967, 114. Cited by RICKETSON, S., GINSBURG, J.C., *International Copyright and Neighbouring Rights. The Berne Convention and Beyond*, Vol. I, Oxford University Press, New York 2005, p. 799, n°13.52.

<sup>1714</sup> RICKETSON, S., GINSBURG, J.C., *International Copyright and Neighbouring Rights. The Berne Convention and Beyond*, vol. I, Oxford University Press, New York 2005, p. 799, n°13.52.

<sup>1715</sup> RICKETSON, S., GINSBURG, J.C., *International Copyright and Neighbouring Rights. The Berne Convention and Beyond*, Vol. I, Oxford University Press, New York 2005, p. 799, n°13.52.

and that quotation could not sufficiently help its purpose.<sup>1716</sup> Finally, it was decided to keep the exception, now article 10*bis*(1), and to extend it to broadcasts.<sup>1717</sup>

As stated in the IViR Implementation Study, “[t]he possibility for a newspaper to reproduce articles published in other newspapers or periodicals always had an important economic component, apart from contributing to the free flow of information.<sup>1718</sup> The basic idea behind this limitation is the fact that newspaper publishers and broadcasting organisations constantly borrow articles from each other, and that through this *quid pro quo*, the limitation ultimately does not affect their respective interests.”<sup>1719</sup> Following IViR, the exception formalizes a common practice of the press members, which frequently republish articles of colleagues. Consequently, if the exception is broadened to other beneficiaries than the press, without any exchange of content in favour of the press, the *quid pro quo* disappears; the balance would be broken and those beneficiaries could take unfair advantage of the press.

### C. Conditions

7. The InfoSoc Directive allows national exceptions within the conditions of article 5(3). Conditions may concern works, use, beneficiaries and restrictions as we will explain hereunder.

8. **Works.** The exception is restricted to published articles on current economic, political or religious topics or of broadcast works or other subject-matter of the same character.

Entire works can be taken. The exception is not limited to parts a work.<sup>1720</sup>

All kinds of works and other subject-matter are covered, not only published articles and broadcasts.<sup>1721</sup>

“Other subject-matter” can be those of the four European neighbouring rights.<sup>1722</sup>

“Published articles”: it also covers publications by electronic means.<sup>1723</sup> The Berne Convention specifies that the articles must be published “in newspapers or periodicals” which is not mentioned in the Directive. Does the Berne Convention also cover online publications? Following article 10(2) of the WIPO Copyright Treaty (“WCT”) and the Agreed statement concerning article 10,<sup>1724</sup> article 10*bis* of the Berne Convention may cover online publications, provided that the use comply with the three-step test.<sup>1725</sup> For J.C. Ginsburg and S. Ricketson, after having said that the term ‘broadcast’ in the article of the Berne Convention would not cover “online publications that are available on demand”,<sup>1726</sup> they conclude that there is nothing in

<sup>1716</sup> RICKETSON, S., GINSBURG, J.C., *idem*.

<sup>1717</sup> RICKETSON, S., GINSBURG, J.C., *idem*.

<sup>1718</sup> Author cites: L.M.C.R. GUIBAULT, *Copyright Limitations and Contracts: An Analysis of the Contractual Overridability of Limitations on Copyright*, The Hague, London, Boston, Kluwer Law International, 2002, Information Law Series No. 9, p. 58.

<sup>1719</sup> GUIBAULT, L. *et al.*, *Study on the implementation and effect in Member States' laws of Directive 2001/29/EC on the harmonisation of certain aspects of copyright and related rights in the information society*, IViR, Amsterdam, 2007, p. 53.

<sup>1720</sup> About the Berne Convention: DREIER, T. in DREIER, T. & HUGENHOLTZ B., (eds), “Concise European Copyright Law”, Kluwer, The Netherlands, 2006, p. 47.

<sup>1721</sup> XALABARDER, R., “Google News and Copyright”, in LOPEZ-TARRUELLA, A. (ed.), *Google and the Law. Empirical approaches to legal aspects of knowledge-economy business models*, Springer, The Netherlands, 2012, p. 145.

<sup>1722</sup> BECHTOLD, T., in DREIER, T. & HUGENHOLTZ B., (eds), *Concise European Copyright Law*, Kluwer, The Netherlands, 2006, p. 379; WALTER, M. W. & VON LEWINSKI, S. (eds), *European Copyright Law. A commentary*, Oxford University Press, U.K., 2010, p. 1048, n°11.5.56.

<sup>1723</sup> WALTER, M. W. & VON LEWINSKI, S. (eds), *European Copyright Law. A commentary*, Oxford University Press, U.K., 2010, p. 1048, n°11.5.55.

<sup>1724</sup> WIPO Copyright Treaty, 20 December 1996, adopted in Geneva.

<sup>1725</sup> XALABARDER, R., “Google News and Copyright”, in LOPEZ-TARRUELLA, A. (ed.), *Google and the Law. Empirical approaches to legal aspects of knowledge-economy business models*, Springer, The Netherlands, 2012, p. 144.

<sup>1726</sup> RICKETSON, S., GINSBURG, J.C., *International Copyright and Neighbouring Rights. The Berne Convention and Beyond*, Vol. I, Oxford University Press, New York 2005, p. 801, n°13.53.4.

article 10*bis*(1) that excludes the extension of the provision from traditional hardcopy newspapers and periodicals to electronic versions that are made available online, and that it would finally be a matter of national legislation.<sup>1727</sup>

Articles on “economic, political or religious topics”: these only three topics exclude many works. Articles on other subjects are not covered, for example a review of films or of art exhibits, articles on scientific news or technical matters or sport reports.<sup>1728</sup>

“Current” topics: The word “current” “means of immediate importance, rather than topics discussed within a longer-term framework.”<sup>1729</sup> They “are events that take place close to the time of use and, within this time frame, still have an informatory value and interest for the public”<sup>1730</sup>. The works in question “must be of immediate importance, as the purpose behind the exception was to expedite the free flow of information on current events.”<sup>1731</sup> Longer articles which review these topics in a longer-term framework should not therefore be included”<sup>1732</sup>.

Broadcast works or other subject matter “of the same character” also refer to current economic, political or religious topics.<sup>1733</sup>

To deal with all kind of works referred to in the Directive, which can be the object of press review including press clippings (see paragraph 14 below), we will in this Study speak about “news works”, because it is broader than only articles published in newspapers and magazines.

9. **Use.** The exceptions may apply to all uses, *i.e.* acts of reproduction, communication to the public or making available (art. 2 and 3 of the Directive). In case the Member States make an exception to the reproduction right, they are free to provide the same exception to the distribution right (art. 5(4) of the Directive)<sup>1734</sup>.

10. **Beneficiaries.** The exception to the reproduction right should be meant to benefit the press (*confer* article 5(3)(c) “reproduction by the press”).

In accordance with the wording of the Directive, we consider here as “beneficiaries” the press. One could also consider as beneficiaries the ultimate beneficiaries, *i.e.* the readers of the news works, but this is not the notion of beneficiaries that is used in the Directive, nor in this Study.

The notion of press is not defined in the Directive.

---

<sup>1727</sup> RICKETSON, S., GINSBURG, J.C., *idem*.

<sup>1728</sup> WALTER, M. W. & VON LEWINSKI, S. (eds), *European Copyright Law. A commentary*, Oxford University Press, U.K., 2010, p. 1048, n°11.5.56; RICKETSON, S., GINSBURG, J.C., *International Copyright and Neighbouring Rights. The Berne Convention and Beyond*, vol. I, Oxford University Press, New York 2005, p. 800, n°13.53.3.

<sup>1729</sup> About the Berne Convention: DREIER, T. in DREIER, T. & HUGENHOLTZ B., (eds), *Concise European Copyright Law*, Kluwer, The Netherlands, 2006, p. 47.

<sup>1730</sup> WALTER, M. W. & VON LEWINSKI, S. (eds), *European Copyright Law. A commentary*, Oxford University Press, U.K., 2010, p. 1048, n°11.5.56.

<sup>1731</sup> Authors cite: Note, for example, the statement of the Czech delegate which implies that he saw this as being concerned principally with statements by public figures.

<sup>1732</sup> About the Berne Convention: RICKETSON, S., GINSBURG, J.C., *International Copyright and Neighbouring Rights. The Berne Convention and Beyond*, Vol. I, Oxford University Press, New York 2005, p. 800, n°13.53; RICKETSON, S., *WIPO study on limitations and exceptions of copyright and related rights in the digital environment*, WIPO, 2003, SCCR/9/7, p. 17, at [http://www.wipo.int/meetings/en/doc\\_details.jsp?doc\\_id=16805](http://www.wipo.int/meetings/en/doc_details.jsp?doc_id=16805)

<sup>1733</sup> WALTER, M. W. & VON LEWINSKI, S. (eds), *European Copyright Law. A commentary*, Oxford University Press, U.K., 2010, p. 1048, n°11.5.56.

<sup>1734</sup> Unlike the Berne Convention, the Information Society Directive does harmonise the distribution right in art. 4. The exceptions may apply to this right in accordance with art. 5(4) of the Directive.

In everyday language, “the press” covers the newspapers, magazines, television and radio that broadcast news, or journalists who work for them, viewed collectively.<sup>1735</sup>

Under “the press”, one traditionally understands the print media, such as newspapers and magazines, and also TV, news programs. However, legal commentators state that it does not in principle prevent extension to online editions of newspapers and magazines, *i.e.* the electronic press.<sup>1736</sup>

It would in any case be a difficult exercise to draw a clear-cut definition of the “press”. There will always be borderline cases and it may have an impact in other sectors than copyright (freedom of expression, defamation, right of response, etc.). The same remark can be made about journalists.

To be qualified as a member of the press, there is a need of a human intervention; a minimum of editing process is required (see below, point 24).

At the Council of the European Union meeting on 15 September 2000, the Netherlands delegation recalled that Member States remain free to further define in their legislation the notion of “press” in article 5(3)(c).<sup>1737</sup>

While “reproduction” seems limited to “the press”, the “communication to the public” and “making available” may in theory be carried out by anyone.<sup>1738</sup> Technically, it is however rather difficult to imagine, in the current state of the art, any communication to the public or any making available that does not involve any reproduction. The only possibility we can imagine would be a direct broadcast, but it is uncertain that such is technically possible. As a consequence, the restriction following which the reproduction of a work has to be made “by the press” also applies in practice to communication to the public and making available.

We will study the beneficiaries of the press review exception more deeply below.

11. **Restrictions.** The permitted use should be restricted to cases where the use is not expressly reserved, and as long as the source, including the author's name, is indicated.

“*Expressly reserved*”. The right holders of the works can prevent the effects of this limitation by expressly reserving the rights described in art. 5(3)(c). For some authors, since such a reservation concerns the use of an individual work, the indication of the source “has to be made with regard to each individual article or each individual broadcast,”<sup>1739</sup> “a rightholder must equip each individual article or other subject matter with an express reservation, rather than making a general reservation in, for example, a masthead”<sup>1740</sup>. For others, “[t]he provision does not describe in which way such reservation is required and thus leaves

---

<sup>1735</sup> Cambridge Dictionary at <http://dictionary.cambridge.org/dictionary/british/> and Oxford dictionaries at <http://oxforddictionaries.com/>

<sup>1736</sup> WALTER, M. W. & VON LEWINSKI, S. (eds), *European Copyright Law. A commentary*, Oxford University Press, U.K., 2010, p. 1047, n°11.5.55; Opinion Advocate General Trstenjak, 12 February 2009, case C-5/08, Infopaq, para. 118 and footnote 54 (citing: Berger, C., ‘Elektronische Pressespiegel und Informationsrichtlinie. Zur Vereinbarkeit einer Anpassung des § 49 UrhG an die Pressespiegel-Entscheidung des BGH mit der Informationsrichtlinie’, *Computer und Recht*, No 5/2004, p. 363; Glas, V., *Die urheberrechtliche Zulässigkeit elektronischer Pressespiegel. Zugleich ein Beitrag zur Harmonisierung der Schranken des Urheberrechts in den Mitgliedstaaten der EU*, Mohr Siebeck, Tübingen 2008, p. 131); RICKETSON, S., GINSBURG, J.C., *International Copyright and Neighbouring Rights. The Berne Convention and Beyond*, Vol. I, Oxford University Press, New York 2005, p. 801, n°13.53.4.

<sup>1737</sup> Council of the European Union, 15 September 2000, Proposal for a directive of the European Parliament and of the Council on the harmonisation of certain aspects of copyright and related rights in the information society, Common position, Statement for the Council minutes, 1997/0359 (COD), p. 6.

<sup>1738</sup> BECHTOLD, T., in DREIER, T. & HUGENHOLTZ B., (eds), *Concise European Copyright Law*, Kluwer, The Netherlands, 2006, p. 379.

<sup>1739</sup> About the BC: DREIER, T. in DREIER, T. & HUGENHOLTZ B., (eds), *Concise European Copyright Law*, Kluwer, The Netherlands, 2006, p. 47.

<sup>1740</sup> BECHTOLD, S., in DREIER, T. & HUGENHOLTZ B., (eds), *Concise European Copyright Law*, Kluwer, The Netherlands, 2006, p. 379.

flexibility to determine by national law any particular way of reserving right, including whether it must be related to each individual article, broadcast work, or other subject matter, or whether it may be generally expressed in respect of all works or achievements of a right holder.”<sup>1741</sup>

“*Indication of the source*”. The source must indicate at a minimum the author’s name. The text of origin in the Berne Convention did not mention “including the author’s name”. In part 2 of the article, the indication of the author’s name is not required if it is impossible (“for example, due to the news reporting format or the extraordinary effort it would take to identify the source”<sup>1742</sup>). “Given the declaratory nature of this phrase, it may, however, be concluded that the absence of this phrase in this context does not translate into any specific meaning”<sup>1743</sup>.

Exceptions in the national copyright laws should be in conformity with the three-step test. The obligation to pay an equitable remuneration will weigh on the balance under the three-step test. We will examine this below.

#### D. Article 5(3)(c) in the case law of the European Court of Justice

12. Up until now, the Court of Justice of the European Union (hereafter the “CJEU”) has no case law regarding the exception for press review. Article 5(3)(c) is not affected by any preliminary ruling. But companies offering media monitoring services intervened in several cases regarding copyright, such as *Infopaq*<sup>1744</sup> or *Meltwater*<sup>1745</sup>.

In those cases, the Court was not interrogated on the interpretation of art. 5(3)(c). However, Advocate General Trstenjak in the case *Infopaq* examined the applicability of the article to the case. Her answer was that the reproduction in part of newspaper articles in the form of extracts could not be justified on the basis of the two exceptions provided for in article 5(3)(c).<sup>1746</sup> We will examine her position below.

## II. Press clippings

The three cases we will examine in chapter IV and V of this Study have in common the offer of “press clippings” to different kinds of beneficiaries, other than the “press” in its traditional meaning.

In the present chapter, we will thus briefly explain what is a press clipping (and some related concepts), who are the stakeholders involved in the press clippings activity and whether press clippings are protected by copyright.

---

<sup>1741</sup> WALTER, M. W. & VON LEWINSKI, S. (eds), *European Copyright Law. A commentary*, Oxford University Press, U.K., 2010, p. 1048, n°11.5.56.

<sup>1742</sup> BECHTOLD, S., in DREIER, T. & HUGENHOLTZ B., (eds), *Concise European Copyright Law*, Kluwer, The Netherlands, 2006, p. 379.

<sup>1743</sup> WALTER, M. W. & VON LEWINSKI, S. (eds), *European Copyright Law. A commentary*, Oxford University Press, U.K., 2010, p. 1048, n°11.5.56. Authors refer to a paragraph of their book saying that: “First, the obligation in the Information Society Directive to indicate not only the source but also the author’s name may be interpreted as having a declaratory nature, given the obligation under the Berne Convention (by which all EC Member States are bound) to provide for authors’ moral right to claim authorship. Secondly, the exception from this obligation in the Information Society Directive in cases in which such indication turns out to be impossible may also be interpreted as being of a declaratory nature, because it is a general principle of law that law never can oblige anyone to do anything that is impossible (*impossibilium nulla est obligatio*)”.

<sup>1744</sup> CJEU, 16 July 2009, *Infopaq I*, C-5/08 and CJEU, 17 January 2012, *Infopaq II*, C-302/10.

<sup>1745</sup> CJEU, case in progress, *Public Relations Consultants Association (“Meltwater”)*, C-360/13.

<sup>1746</sup> Opinion of Advocate general, 12 February 2009, CJEU, 16 July 2009, *Infopaq International*, C-5/08, para. 118 and 119.

## A. Notion of press clippings and related concepts

13. In everyday language, a **press clipping** is a paragraph or a short article cut out of a newspaper or magazine.<sup>1747</sup> Press clipping services frequently imply that not only one work but a number of them are subject to clipping. In our view, press clippings can also constitute an excerpt of a broadcast, a video or of a photograph report. All the works referred to in article 5(3)(c) of the Directive (also called here “news works”) can thus be the object of a press clipping.

For decades, a business grew on the offer of press clippings of news works, by firms offering media monitoring services and more recently news aggregation websites (Google News, Yahoo! News, etc.).

The activity of press clippings is called **press review** when there is an editing processing of the clippings, an arrangement of them (indexing, compilation, presentation of the clippings e.g. with the headline, a short abstract, the source, links between the clippings etc.). This activity may include the selection, reproduction, compilation, distribution, display of the news works, integrally or in part, by paper or digital means. The press clippings can be emailed, posted on an intranet, spread in the Internet, send through an RSS feed, etc.<sup>1748</sup>

Traditionally, press clippings often include **press summaries** (in French “résumés” or “synthèses”, as in the French translation of the Infopaq cases: “synthèses d’articles de presse”). A summary usually does not comprise any reproduction; it only copies the ideas of a work (e.g. a press article, a news report on TV), which are not protected by copyright. As agreed by the parties in the Infopaq cases “summary writing per se is lawful and does not require consent from the rightholders”<sup>1749</sup>.

A **media monitoring service** (or a press clipping service) provides its clients with press clippings or press reviews, which are of particular interest to them.

**News aggregators** compile press clippings and display them on the internet in a single place. They provide most of the time titles and “snippets” of articles (i.e. extracts of articles, e.g. the 4 or 5 first lines which are often “catchy” and describe the content of the article) they link to. Their users can rank and display the information requested according to their search criteria. The services may be offered for free or under subscription. News aggregators generally generate revenues from online advertising on their websites.<sup>1750</sup>

There are different types of news aggregators. K. Isbell describes four different types of them: feed aggregators, specialty aggregators, user-curated aggregators and blog aggregators.<sup>1751</sup> A “feed aggregator” like Google News ([http://www.google.com/intl/en\\_us/about\\_google\\_news.html](http://www.google.com/intl/en_us/about_google_news.html)) or Yahoo! News (<http://news.yahoo.com/>) “is closest to the traditional conception of a news aggregator, namely, a website that contains material from a number of websites organized into various “feeds,” typically arranged by source, topic, or story. Feed Aggregators often draw their material from a particular type of source, such as news websites or blogs, although some Feed Aggregators will contain content from more

---

<sup>1747</sup> Oxford Dictionaries, <http://oxforddictionaries.com/definition/english/press-clipping>

<sup>1748</sup> XALABARDER, R., “Google News and Copyright”, in LOPEZ-TARRUELLA, A. (ed.), *Google and the Law. Empirical approaches to legal aspects of knowledge-economy business models*, Springer, The Netherlands, 2012, p. 117.

<sup>1749</sup> CJEU, 17 January 2012, *Infopaq II*, C-302/10, para. 23.

<sup>1750</sup> XALABARDER, R., “Google News and Copyright”, in LOPEZ-TARRUELLA, A. (ed.), *Google and the Law. Empirical approaches to legal aspects of knowledge-economy business models*, Springer, The Netherlands, 2012, p. 118.

<sup>1751</sup> The news aggregators can also be categorised on their method to bring news sources together and repackage them. J. Catone compared five different techniques: single stream aggregation, single page aggregation, meme aggregation, people powered aggregation, and edited aggregation. See CATONE, J., “5 News Aggregation Methods Compared”, 10 July 2007, at [http://www.readwriteweb.com/archives/news\\_aggregation\\_methods.php](http://www.readwriteweb.com/archives/news_aggregation_methods.php) cited by ISBELL, K., “The rise of the news aggregators”, 30 August 2010, [http://cyber.law.harvard.edu/publications/2010/news\\_aggregator\\_legal\\_implications\\_best\\_practices](http://cyber.law.harvard.edu/publications/2010/news_aggregator_legal_implications_best_practices)

than one type of source.”<sup>1752</sup> A “specialty aggregator” “is a website that collects information from a number of sources on a particular topic or location.”<sup>1753</sup> A user-curated aggregator “is a website that features user-submitted links and portions of text taken from a variety of websites. Often, the links on a User-Curated Aggregator will be culled from a wider variety of sources than most news aggregators, and will often include links to blog posts and multimedia content like YouTube videos, as well as links to more traditional media sources”<sup>1754</sup>. Finally, a “blog aggregator” “looks the least like a traditional news aggregator. Blog Aggregators are websites that use third-party content to create a blog about a given topic”.<sup>1755</sup>

For institutions or businesses, to read all the press, visit all the news websites every day is time-consuming. It is thus very useful and faster for them to read a report of headlines or abstracts on selected topics. This is the same for the general public, who can have access to more information in a shorter version.

## B. Stakeholders involved

14. The importance of national and European case law, such as the Google cases or Infopaq cases, shows that the problematic between media monitoring services, news aggregators on one side, and authors (journalists, press photographers...) and publishers on the other side is significant.

There are many discussions about the impact of the media monitoring services and news aggregators on the press, but it is not the object of this Study to try to solve the multiple problems between the stakeholders involved. Besides, we do not have (and that would be necessary for such exercise) an exhaustive and accurate market analysis on the issues.

Before answering the question of the applicability of the exception to some particular cases, it is important to know if – and in which conditions – newspaper articles and their clippings are protected by copyright.

## C. Protection of press clippings

15. News works, as well as their titles and abstracts, are susceptible to be protected by copyright to the extent that they are original literary or artistic works.<sup>1756</sup>

Copyright does not protect “news of the day or miscellaneous facts having the character of mere items of press information” (art. 2(8) of the Berne Convention). This provision “is pivotal to press uses because the subject matter it disqualifies is the standard grist of the press mill”<sup>1757</sup>. Thus facts or news items as such – as original as they may be – cannot be copyrightable nor any idea.<sup>1758</sup> Summaries, which borrow and communicate only ideas (or miscellaneous facts) of another news item, do not infringe copyright. News of the day and miscellaneous facts are part of the public domain.<sup>1759</sup> But the news article or the video report

---

<sup>1752</sup> ISBELL, K., “The rise of the news aggregators”, 30 August 2010, p. 2

[http://cyber.law.harvard.edu/publications/2010/news\\_aggregator\\_legal\\_implications\\_best\\_practices](http://cyber.law.harvard.edu/publications/2010/news_aggregator_legal_implications_best_practices)

<sup>1753</sup> ISBELL, K., *idem*, p. 3.

<sup>1754</sup> ISBELL, K., *idem*, p. 4.

<sup>1755</sup> ISBELL, K., *idem*, p. 5.

<sup>1756</sup> Also, press clippings could potentially be protected by the *sui generis* database right, if they constitute a database (ex. the website of a newspaper). The producer of the database (e.g. an editor) could then prohibit the systematic extraction of the content of its database. See Directive 96/9/EC of the European Parliament and of the Council of 11 March 1996 on the legal protection of databases.

<sup>1757</sup> GOLDSTEIN, P & B. HUGENHOLTZ, *International Copyright*, Oxford University Press, Oxford, 2<sup>nd</sup> ed., 2010, p. 382.

<sup>1758</sup> NEELS, L., “Copyright protection for press releases?”, *EIPR*, 1992, n°4, p. 130.

<sup>1759</sup> DUSOLLIER, S., *Scoping study on copyright and related rights and the public domain*, WIPO, 2010, p. 32, at [http://www.wipo.int/edocs/mdocs/mdocs/en/cdip\\_4/cdip\\_4\\_3\\_rev\\_study\\_inf\\_1.doc](http://www.wipo.int/edocs/mdocs/mdocs/en/cdip_4/cdip_4_3_rev_study_inf_1.doc)

selecting and arranging the news give them an expression. This expression of the facts will be protected if it is original.

The CJEU said that a subject-matter is original in the sense that it is its author's own intellectual creation.<sup>1760</sup>

Concerning newspaper articles, "their author's own intellectual creation is evidenced clearly from the form, the manner in which the subject is presented and the linguistic expression".<sup>1761</sup> "It is only through the choice, sequence and combination of those words that the author may express his creativity in an original manner and achieve a result which is an intellectual creation."<sup>1762</sup> For example, the newspaper articles monitored by the company Infopaq are, as such, literary works covered by the Directive.<sup>1763</sup>

Following the Infopaq cases, the Court said that words, as such, do not constitute elements covered by the protection.<sup>1764</sup> But certain isolated sentences, or even certain parts of sentences in a newspaper article, are susceptible to come within the scope of the protection provided for in the Directive. A work comprising 11 words may communicate to the reader an element which is, in itself, the expression of the intellectual creation of the author of that article.<sup>1765</sup>

The act which consists of storing an extract of a protected work and printing out that extract, is such as to come within the concept of partial reproduction within the meaning of the Directive, if the elements thus reproduced are the expression of the intellectual creation of their author.<sup>1766</sup>

In conclusion, as confirmed by the cases Infopaq, press clippings communicate works protected by copyright, if they communicate to the reader an element which is, in itself, the expression of the intellectual creation of the author of the news article or broadcast.

### III. Application

16. In this part we will examine, at the request of the Commission, whether three cases meet the conditions set out in art. 5(3)(c), *i.e.* the offer of press clippings by an organisation to its employees (A), by a (commercial) entity to its subscribers (B) and by any legal entity or natural person to the general public (C).

We have found no CJEU decisions on article 5(3)(c) and little scholarly literature on the notion of beneficiaries of the exception.

For each case, we will examine the compatibility of the use with the three-step test.

17. We saw above who the beneficiaries of the news reporting exception are (paragraph 11 above). As a reminder, reproduction of published articles is only allowed if it is carried out by the "press", but communication to the public and making available may in theory benefit anyone. Communication to the public and making available in the framework of article 5(3)(c) can thus be carried out by the three kinds of potential beneficiaries in the cases identified by the Commission. But acts of communication to the public and making available imply reproduction.

---

<sup>1760</sup> CJEU, 16 July 2009, *Infopaq I*, C-5/08, para. 37.

<sup>1761</sup> CJEU, 16 July 2009, *Infopaq I*, C-5/08, para. 44.

<sup>1762</sup> CJEU, 16 July 2009, *Infopaq I*, C-5/08, para. 45.

<sup>1763</sup> CJEU, 16 July 2009, *Infopaq I*, C-5/08, para. 44.

<sup>1764</sup> CJEU, 16 July 2009, *Infopaq I*, C-5/08, para. 46.

<sup>1765</sup> CJEU, 16 July 2009, C-5/08, *Infopaq I*, para. 45-51.

<sup>1766</sup> CJEU, 16 July 2009, C-5/08, *Infopaq I*, para. 45-51.



The press traditionally comprises journalists, newspapers, periodicals and broadcasting organisations.

In 2007, analysing the implementation and the effect in Member States' laws of the Directive, IViR described in its study two manners to interpret the press review exception. "A narrow interpretation of the news report exception in principle restricts the possibility to reproduce newspaper articles and broadcast commentaries only by press or broadcasting entities of the same nature".<sup>1767</sup>

Following this strict interpretation by IViR, none of the three cases would be allowed. A narrow interpretation of the beneficiaries of article 5(3)(c) prohibits organisations or employers, commercial entities which are not press entities to reproduce, to communicate to the public and make available news works without the consent of the right holders.

A broad interpretation, said IViR, would extend the exception to institutions and enterprises for their subscribers or employees. Thus, case A and B would be allowed, but not case C, still too permissive.

18. The question of the present Study focuses on the beneficiaries of the exception (see Terms of reference above). We recall here that to benefit from the exception, the three cases of uses of the works examined in this Study also need to fulfil the other conditions set forth in article 5(3)(c) (see paragraph 8 above).

We will assume here that all the other conditions of article 5(3)(c) are met in the three cases of application, notably on the topic (economic, political or religious) of the current event and the mention of the source of the work.

19. Since this Study is limited to the assessment of article 5(3)(c) of the Directive, we will not examine in details whether other exceptions can be applicable to the offer of press clippings. We will simply briefly mention the quotation limitation contained in article 10(1) of the Berne Convention and article 5(3)(d) of the Directive.

Article 10(1) of the Berne Convention states the following:

*It shall be permissible to make quotations from a work which has already been lawfully made available to the public, provided that their making is compatible with fair practice, and their extent does not exceed that justified by the purpose, including quotations from newspaper articles and periodicals in the form of press summaries.*<sup>1768</sup>

Article 10(1) of the Berne Convention is mandatory for the Members of the Union (contrary to article 10bis(1)). According to this, Members of the Berne Union are obliged to allow "mere quotations" and "quotations from newspaper articles and periodicals in the form of press summaries", regardless of whether their national laws are broader or narrower<sup>1769</sup>. Since all Member States of the European Union are also Members of the Berne Convention, they all provide for such an exception for quotations from newspaper articles and periodicals, if it is done to the extent justified by the purpose and provided that their making is compatible with fair practice.<sup>1770</sup>

<sup>1767</sup> GUIBAULT, L. *et al.*, *Study on the implementation and effect in Member States' laws of Directive 2001/29/EC on the harmonisation of certain aspects of copyright and related rights in the information society*, IViR, Amsterdam, 2007, p. 53 (the "IViR Implementation Study").

<sup>1768</sup> Confusion can arise from the French translation of the text, in fact "press summaries" is translated in French by "revues de presse". In this study, a "summary" is translated in French by "résumé". In the same sense as in the Infopaq cases, where "press summaries" are translated by "synthèses de presse".

<sup>1769</sup> XALABARDER, R., "Google News and Copyright", in LOPEZ-TARRUELLA, A. (ed.), *Google and the Law. Empirical approaches to legal aspects of knowledge-economy business models*, Springer, The Netherlands, 2012, p. 136.

<sup>1770</sup> Examples: France (art L122-5(3)(a)), Luxembourg (art. 10.1), Spain (art. 32.1), the Netherlands (art. 15 a permits quotations for purposes of criticism and research and says expressly that "the term 'quotations' shall also include quotations in the form of press summaries from articles appearing in a daily or weekly newspaper or other periodical") and Germany (art. 51). See an application of the quotation of press articles in France, in the Microfor arrest of the Cour de cassation (indexing of titles and short extract of news articles published in the print newspapers): Cass., 30 October 1987, cited by XALABARDER, R., "Google News and Copyright", in

This provision and article 5(3)(d) of the Directive make no reference to particular beneficiaries. Quotations can thus be made by anyone.

Article 5(3)(d) of the Directive makes no reference to press summaries as such:

*3. Member States may provide for exceptions or limitations to the rights provided for in Articles 2 and 3 in the following cases:*

(...)

*(d) quotations for purposes such as criticism or review, provided that they relate to a work or other subject-matter which has already been lawfully made available to the public, that, unless this turns out to be impossible, the source, including the author's name, is indicated, and that their use is in accordance with fair practice, and to the extent required by the specific purpose;*

Does the reference to the purposes of “review” imply the making of press clippings? Arguments can be raised for and against it.<sup>1771</sup>

The exception is facultative for Member States, which are free to implement it or not.

### A. The offer by an organisation to its employees

20. The question here is to know whether article 5(3)(c) authorises an organisation or an employer to provide a press-clippings service to their employees. It is often called “in-house press clippings”.

A **narrow interpretation** of the beneficiaries of article 5(3)(c) prohibits organisations or employers who are not press entities to reproduce, communicate to the public and make available news works without the consent of the right holders. In this sense, M. Walter and S. von Lewinski said that “if companies that are not press companies produce in-house electronic press clippings, it is rather doubtful whether they are covered by lit (c), or under any other exception or limitation under Article 5.”<sup>1772</sup>

As the IViR said, a **broad interpretation** of the beneficiaries of article 5(3)(c) would allow organisations, commercial or not, to offer in-house press clippings; “a broad interpretation of this limitation extends the privilege to institutions and enterprises that offer second-hand information on selected topics to their subscribers or employees in the form of collections of newspaper clippings”.<sup>1773</sup>

We did however not find any other scholarly literature or case law arguing that article 5(3)(c) could be broadly interpreted.

According to the CJEU's case law, the exceptions to copyright must be interpreted strictly, since they are derogations from the general rule established by the Directive.<sup>1774</sup> The fact remains that the interpretation of the conditions of application of an exception must also enable the effectiveness of the exception thereby established to be safeguarded and its purpose to be observed.<sup>1775</sup> But this little margin does not

LOPEZ-TARRUELLA, A. (ed.), *Google and the Law. Empirical approaches to legal aspects of knowledge-economy business models*, Springer, The Netherlands, 2012, p. 125.

<sup>1771</sup> See the arguments in XALABARDER, R., “Google News and Copyright”, in LOPEZ-TARRUELLA, A. (ed.), *Google and the Law. Empirical approaches to legal aspects of knowledge-economy business models*, Springer, The Netherlands, 2012, p. 137.

<sup>1772</sup> WALTER, M. W. & VON LEWINSKI, S. (eds), *European Copyright Law. A commentary*, Oxford University Press, U.K., 2010, p. 1047, n°11.5.55. Authors cites the Implementation Study of the IViR, p. 53, with reference to the Dutch Supreme Court of 10 November 1995 (“Knipselkranten”); see para. 32 hereafter.

<sup>1773</sup> GUIBAULT, L. et al., *Study on the implementation and effect in Member States' laws of Directive 2001/29/EC on the harmonisation of certain aspects of copyright and related rights in the information society*, IViR, Amsterdam, 2007, p. 53.

<sup>1774</sup> CJEU, 16 July 2009, C-5/08, *Infopaq I*, para. 56; CJEU, 4 October 2011, *Football Association Premier League and Others*, C-403/08, para. 162; CJEU, 1 December 2011, *Painer c. Standard*, C-145/10, para. 109 (and the cited case law).

<sup>1775</sup> CJEU, 4 October 2011, *Football Association Premier League and Others*, C-403/08, para. 163 and CJEU, 1 December 2011, *Painer c. Standard*, C-145/10, para. 133. JANSSENS, M.-C., in BRISON, F., & VANHEES, H. (eds.), *Hommage à Jan Corbet. La loi*

allow in our opinion to extend the benefit granted to the “press” to any employer or institution. This is not the purpose of the exception.

21. Would the offer of press clippings to employees meet the conditions of the **three-step test**?

Following article 5(5) of the Directive and in line with the international instruments,<sup>1776</sup> the exceptions of article 5 apply, (1) only in clearly specified special cases which (2) are not contrary to a normal exploitation of the work and which (3) do not unreasonably prejudice the legitimate interests of the right holders.

The **first step** requires that the limitation be restricted to “certain special cases”. That condition means that the exceptions must be clearly defined and must be based on specified particular objectives.<sup>1777</sup> Authors converge on the view that the requirement stems from a qualitative understanding and favours exceptions that are of public interest.<sup>1778</sup>

Article 5(3)(c) of the Directive constitutes a special case in the sense of the three-step test, because it draws on article 10*bis* of the Berne Convention.<sup>1779</sup> Hence, the exception passes the first condition of the test.

If article 5(3)(c) of the Directive was not restricted to the press, but broadened to the internal uses of press clippings in an organisation, would it still pass the first step? The offer of press clippings to the employees of a company has the objective to inform them about current events. The organisation can also have a commercial objective, the press clippings being then able to improve the commercial efficiency of the organisation.

According to Advocate General Tstenjak in the Infopaq case, it can be stated that a reproduction of extracts from newspaper articles does not correspond entirely to the objective of informing the public and that its primary objective is commercial. However, when a journal publishes an article from another journal or when one hears on the radio a part of a newspaper article, these media use the works not only to inform the public, but also for commercial advantage. One can therefore, in the Advocate general’s opinion, also state concerning the reproduction of extracts from newspaper articles that, when they are used to draw up summaries of those articles, they are used to inform the public.<sup>1780</sup>

*belge sur le droit d’auteur*, Larcier, Brussels, 2012, 3<sup>rd</sup> ed., p. 150, note 14 – 15. About the interpretation of the exceptions, see TRIAILLE, J.-P., *Report on User Generated Content (UGC) – First Part*, in this document.

<sup>1776</sup> Art. 9(2) of the Berne Convention, art.10 of the Wipo Copyright Treaty and art.13 TRIPS Agreement. The CJEU declared that the provisions of the TRIPS Agreement are applicable in the legal order of the European Union, hence also the TRIPS three-step test CJEU, 15 March 2012, C-135/10, *SCF v. Del Corso*, para. 56.

<sup>1777</sup> Opinion of Advocate General Trstenjak, 12 February 2009, C-5/08, *Infopaq International A/S v. Danske Dagblades Forening*, para. 135.

<sup>1778</sup> SENFTLEBEN, M., *Copyright, limitations and the three-step test. An analysis of the three-step test in international and EC Copyright law*, Kluwer International, The Hague, London, New York, 2004; DUSOLLIER, S., « L’encadrement des exceptions au droit d’auteur par le test des trois étapes », *I.R.D.I.*, 2005, p. 213-223. However, the WTO Panel was against such a normative approach.

<sup>1779</sup> SENFTLEBEN, M., *Copyright, limitations and the three-step test. An analysis of the three-step test in international and EC Copyright law*, Kluwer International, The Hague, London, New York, 2004, p. 155 – 157 and 260.

<sup>1780</sup> « If the Court finds that the reproduction of extracts from newspaper articles constitutes a lawful use pursuant to Article 5(3)(c) of Directive 2001/29, that would implicitly be on the assumption that the reproduction of extracts from newspaper articles constitutes informing the public. It can certainly be stated that that reproduction in part of newspaper articles in the form of extracts does not correspond entirely to that objective and that its primary objective is commercial, the provision of information being a secondary objective. However, when, for example, a journal publishes an article from another journal, when one hears on the radio a part of a newspaper article or records a certain part of an exhibition during a television programme on that exhibition, these media use the works not only to inform the public, but also on the contrary for commercial advantage. One can therefore, in my opinion, also state concerning the reproduction of extracts from newspaper articles that, when they are used to draw up summaries of those articles, they are used to inform the public. In my opinion it can therefore be found that this is a special case within the meaning of the first condition of Article 5(5) of Directive 2001/29. The first condition of Article 5(5) of Directive 2001/29 is therefore fulfilled as regards the printing of extracts from newspaper articles. » Opinion of Advocate General Trstenjak, 12 February 2009, C-5/08, *Infopaq International A/S v. Danske Dagblades Forening*, para. 136.

Consequently, it seems that the internal use of a news work can be found to be a "special case" and the first step could be considered as fulfilled.

The **second step** requires that the use does not conflict with the normal exploitation of the work. For to the WTO Panel, "normal exploitation" includes both current and potential future uses of the work and must be judged for each exclusive right individually.<sup>1781</sup> Advocate General Trstensjak explains that "[t]he normal exploitation of newspaper articles means that the newspapers in which the articles are published are sold and that a profit is made therefrom; the economic advantages which may be made from newspaper articles must go to the copyright holders. If the effect on the newspaper market is noticeable and the sale of newspapers diminishes, this goes against normal exploitation".<sup>1782</sup>

About article 5(3)(c) of the Directive, a commentator said that when an article on current topics is used, a "potential major source of royalty revenue need not be expected".<sup>1783</sup> Besides, the use of those articles can be reserved. Article 5(3)(c) is therefore, when limited to uses by the press (*confer* the *quid pro quo rationale* argument explained below, paragraph 24), not in conflict with a normal exploitation and the exception passes the second step of the test.

Concerning the application of the second step to the offer of press clippings to employees, it makes no doubt that the internal use of press clippings constitutes an important source of royalty revenue for the right holders. Those uses conflict, in our view, with a normal exploitation of the work within the meaning of the second condition of article 5(5) of the Directive.

If it is decided to extend the actual article 5(3)(c) of the Directive to the offer of press clippings within organisations, it must be provided for a measure to overcome the conflict with the second condition of article 5(5) of the Directive. The requirement of the second step could possibly be met by the payment of an equitable remuneration to the right holder, *i.e.* turn the exception into a remuneration right (yet there is controversy on whether introducing a remuneration right *per se* is sufficient to avoid a conflict with the three-step test).

The conditions set forth in the three-step test are cumulative. Because the second condition is not met, a judge would not analyse if the third condition is fulfilled .

The **third step** requires that the use does not unreasonably prejudice the right holder's legitimate interests. For Advocate general Trstensjak, an effect on the legitimate interests of the right holders is not sufficient but it cannot be unjustified. The quantitative and qualitative nature of the effect must be taken into account.<sup>1784</sup>

If article 5(3)(c) is interpreted as allowing uses of press clippings inside a company or an organisation, a substantial quantity of press clippings would be produced. In our opinion, this would cause an unreasonable prejudice to the legitimate interests of the right holders. The third condition would thus not be fulfilled either.

In conclusion, the offer of press clippings by an organisation to its employees does not, as such, pass the test of article 5(5) of the Directive. To pass the test, the conditions of the provision should be arranged,

---

<sup>1781</sup> WTO, 15 June 2000, Report of the Panel, WT/DS160/R, at [http://www.wto.org/english/tratop\\_e/dispu\\_e/1234da.pdf](http://www.wto.org/english/tratop_e/dispu_e/1234da.pdf)

<sup>1782</sup> Opinion of Advocate General Trstenjak, 12 February 2009, C-5/08, *Infopaq International A/S v. Danske Dagblades Forening*, para. 137, citing FICSOR, M., *The Law of Copyright and the Internet. The 1996 WIPO Treaties, their Interpretation and Implementation*, Oxford University Press, New York, 2002, p. 516, section C10.03; REINBOTHE, J. and VON LEWINSKI, S., *The WIPO Treaties 1996. The WIPO Copyright Treaty and The WIPO Performances and Phonograms Treaty. Commentary and Legal Analysis*, Butterworths, London, 2002, p. 125, para. 18.

<sup>1783</sup> SENFTLEBEN, M., *Copyright, limitations and the three-step test. An analysis of the three-step test in international and EC Copyright law*, Kluwer International, The Hague, London, New York, 2004, p. 269 – 270.

<sup>1784</sup> Opinion of Advocate General Trstenjak, 12 February 2009, C-5/08, *Infopaq International A/S v. Danske Dagblades Forening*, para. 139.

e.g. by providing an equitable remuneration to the right holders. And even so, it is not clear if the three-step test would be passed.

## B. The offer by a (commercial) entity to its subscribers

22. The offer of press clippings by an entity, commercial or not, to its subscribers can for example be a media monitoring company which offers press clippings to its clients or an association to its members. It can also be the case of a news aggregator who sends RSS feeds to its subscribers (<https://support.google.com/news/answer/59255?hl=en>).

As for case A, only a broad interpretation of the notion of press can allow those entities to benefit from the exception.

The Advocate General Trstenjak asked the question of the application of the exception provided for in article 5(3)(c) to the uses made by Infopaq, a media monitoring company.<sup>1785</sup>

Infopaq offers media monitoring and analysis services to its clients. Its business consists primarily in drawing up summaries of selected articles from Danish newspapers and other periodicals (represented by the Danske Dagblades Forening or “DDF”, a professional association of Danish daily newspapers). The summaries were based on press clippings. More precisely, Infopaq was doing reproduction in part of newspaper articles in the form of extracts of 11 words.

For the Advocate General, the press review exception “cannot justify such reproduction as it is not reproduction in the press as newspapers and magazines traditionally come under”<sup>1786</sup>. She added that for her, the case does not concern distribution to the public or making published articles available to the public.<sup>1787</sup>

By excluding a media monitoring company, Advocate General Trstenjak is thus in favour of a strict interpretation of the notion ‘press’. For him, the offer of press clippings in case B (and *a fortiori* also case C – except press clippings offered by press entities to the general public) does not meet the condition of the beneficiary of the press review exception.

We did not find any case law or scholarly articles advocating a broader interpretation of the notion of press (except the IViR Study, which actually only evoke it, without justifying it).

---

<sup>1785</sup> Opinion of Advocate General Trstenjak, 12 February 2009, C-5/08, *Infopaq International A/S v. Danske Dagblades Forening*, para. 118.

<sup>1786</sup> Opinion of Advocate General Trstenjak, 12 February 2009, C-5/08, *Infopaq International A/S v. Danske Dagblades Forening*, para. 118. Advocate General cites: See, for example, BERGER, C., ‘Elektronische Pressespiegel und Informationsrichtlinie. Zur Vereinbarkeit einer Anpassung des § 49 UrhG an die Pressespiegel-Entscheidung des BGH mit der Informationsrichtlinie’, *Computer und Recht*, No 5/2004, p. 363; GLAS, V., *Die urheberrechtliche Zulässigkeit elektronischer Pressespiegel. Zugleich ein Beitrag zur Harmonisierung der Schranken des Urheberrechts in den Mitgliedstaaten der EU*, Mohr Siebeck, Tübingen 2008, p. 131. It is also apparent from legal commentary on the interpretation of Article 10bis(1) of the Berne Convention on the model of which the first exception provided for in Article 5(3) was included in Directive 2001/29, that newspapers and magazines generally fall within that exception: see for example RICKETSON, S., *The Berne Convention for the protection of literary and artistic works: 1886-1986*, Centre for Commercial Law Studies, Queen Mary College, Kluwer, London 1987, p. 501, section 9.30, and p. 503, section 9.32. Legal commentators also state that Article 10bis(1) of the Berne Convention does not in principle prevent extension to online editions of newspapers and magazines: see on that subject Ricketson, S., Ginsburg, J.C., *International Copyright and Neighbouring Rights. The Berne Convention and Beyond*, Vol. I, Oxford University Press, New York 2005, p. 801, paragraph 4.

<sup>1787</sup> He also asked the question of the application of the second exception of article 5(3)(c) for reporting of current events. For him, it does not justify the reproduction in part of newspaper articles in the form of extracts. “That exception in fact authorises the use of works in connection with the independent activity of providing information on current events”, “a given work may therefore be used in the context of providing information on a given current event. Moreover, if it was allowed that newspaper articles could be reproduced on the basis of the exception which authorises reporting of current events, that would run counter to the purpose of the first exception provided for in Article 5(3)(c), which specifically concerns reproduction, communication to the public and making available of articles on current economic, political or religious topics or other subject-matter of the same character and which, as regards those articles, constitutes the *lex specialis* in relation to the second exception in that article.” (para. 119).

However, the Court of justice mentioned in *Infopaq II* when referring to the drafting of press summaries that: “In respect of the lawful or unlawful character of the use, it is not disputed that the drafting of a summary of newspaper articles is not, in the present case, authorised by the holders of the copyright over these articles. However, it should be noted that such an activity is not restricted by European Union legislation. Furthermore, it is apparent from the statements of both *Infopaq* and the DDF that the drafting of that summary is not an activity which is restricted by Danish copyright legislation.”<sup>1788</sup>

As L. Guibault says, “[u]nfortunately, this sole mention of the lawfulness of *Infopaq*’s drafting of summaries does not say much about the admissible scope of the press exception under European law. The whole case shows, however, that the emergence of digital news monitoring services constitutes a serious threat for traditional newspaper publishers.”<sup>1789</sup>

Regarding the question if the opening of the exception of article 5(3)(c) of the Directive to the offer of press clippings by a (commercial) entity to its subscribers meet the conditions of the **three-step test**, we can refer to the reasoning of Advocate General Trstenjak in the case *Infopaq*.<sup>1790</sup>

For the same reasons as for the offer to employees (see point 22 above), the **first condition** is fulfilled.

According to the Advocate General, the reproduction of extracts from newspaper articles affects the normal exploitation of those newspapers (as a reminder, we here speak about an extract of an article and not a summary, which is not an infringement to copyright).

*The reproduction of extracts from newspaper articles allows Infopaq to identify rapidly which articles are important and of which a summary must be drawn up. Infopaq can thus draw up summaries of all newspaper articles, for which reason its customers no longer need to buy newspapers.*<sup>1791</sup>

The **second condition** of article 5(5) of the Directive is consequently not fulfilled.

Advocate General continued and analysed the **third condition** of the test, which provided that the particular cases in which the exceptions and limitations apply do not unreasonably prejudice the legitimate interests of the rightholders. He also concluded that concerning the printing of extracts from newspaper articles the condition was not fulfilled. He explains that:

*[i]n the context of the third condition, the mere effect on the legitimate interests of the rightholders – who are ultimately affected by each exception and limitation – is not sufficient; that effect cannot on the contrary be unjustified. On this occasion the quantitative and qualitative nature of the effect must be taken into account.*<sup>1792</sup>

*In the present case, an extract from a newspaper article is produced for all of the articles containing the relevant search words. If the search word appears frequently in those articles, that means quantitatively that extracts from newspaper articles may be produced for numerous articles. If several different search words appear in the same article, that also means that several extracts may be produced for an article. I have already found when analysing the second*

<sup>1788</sup> CJEU, 17 January 2012, *Infopaq II*, C-302/10, para. 44.

<sup>1789</sup> GUIBAULT, L., “The Press Exception in the Dutch Copyright Act”, in HUGENHOLTZ, P.B., QUAEDVLIEG, A.A., & VISSER, D.J.G., (eds.), *A Century of Dutch Copyright Law. Auteurswet 1912-2012*, Amsterdam, 2012, p. 670.

<sup>1790</sup> Opinion of Advocate General Trstenjak, 12 February 2009, C-5/08, *Infopaq International A/S v. Danske Dagblades Forening*, para. 134 – 141.

<sup>1791</sup> Opinion of Advocate General Trstenjak, 12 February 2009, C-5/08, *Infopaq International A/S v. Danske Dagblades Forening*, para. 138.

<sup>1792</sup> Opinion of Advocate General Trstenjak, 12 February 2009, C-5/08, *Infopaq International A/S v. Danske Dagblades Forening*, para. 139. She cites FICSOR, M., *The Law of Copyright and the Internet. The 1996 WIPO Treaties, their Interpretation and Implementation*, Oxford University Press, New York 2002, p. 516, section C10.03 and REINBOTHE, J., VON LEWINSKI, S., *The WIPO Treaties 1996. The WIPO Copyright Treaty and The WIPO Performances and Phonograms Treaty. Commentary and Legal Analysis*, Butterworths, London 2002, pp. 126-127, para. 22.

*condition of Article 5(5) of Directive 2001/29 that the reproduction of those extracts has an indirect effect when summaries are produced on the sale of the newspaper articles, for which reason the copyright holders also have a legitimate interest in the profits made by Infopaq. Given that the extracts are produced for a large number of articles, that constitutes in my opinion an unreasonable prejudice to the legitimate interests of the rightholders.*<sup>1793</sup>

As for the offer to employees, we will conclude that the offer of press clippings by an (commercial or non-commercial) entity, without the consent of the right holders, does not comply with the three-step test.

### C. The offer by any legal entity or natural person to the general public

23. This third case, which aims the offer of press clippings by any legal entity or natural person to the general public, includes the practice of news aggregators website, such as Google News (on the notion of news aggregators, see point 14 above). It also covers journalists, online newspapers, bloggers or people communicating on social networks.

Could those services be considered as the “press” in the sense of article 5(3)(c)?

For journalists and online newspapers or periodicals, it makes no doubt that there are an integral part of the press and may benefit from the exception if they respect the other conditions of article 5(3)(c)<sup>1794</sup>.

Concerning the reuse of news works by news aggregators, the IViR explained very pertinently in its Implementation Study, that it may put under pressure the *quid pro quo rationale* underlying the limitation. In fact, the *ratio legis* of the exception (besides the objective of the free flow of information) lies in the fact that press entities (newspapers or broadcasting organisations) constantly borrow news works from each other.<sup>1795</sup> Following the IViR, “[i]f second-comers can freely reproduce articles of newspapers and periodicals without offering the original newspaper publisher with the opportunity to do the same, then the *quid pro quo rationale* underlying the limitation is put under pressure.”<sup>1796</sup>

The IViR continued by saying that “[o]n the other hand, distinguishing between value-added news media that ‘deserve’ to benefit from the exemption, and other media that do not, bears the risk of passing judgment on the social value of the media, and would therefore rest uneasily with freedom of expression. Consequently, it is uncertain whether services like Google News would be covered by the limitation of article 5(3)(c) of the Directive, in the countries that have implemented it. The direct consequence of the prevailing legal uncertainty regarding the (un)lawfulness of Google’s use of copyrighted newspaper articles, drawings and photographs has been to launch the company on the path of negotiations with the newspaper publishers, photographers and journalists in order to contractually determine the conditions for the use of copyrighted material on its different services.”<sup>1797</sup>

While we agree with the remark of the IViR on the *quid pro quo rationale* of the exception which could be put under pressure, we do not fully agree with its conclusion saying that, because of the risk of a judgment on the media, it is uncertain whether Google News would be covered by the exception of article 5(3)(c) of the Directive. It is true that the provision has as original objective to facilitate the free flow of information and that Google News aims to inform the public. Though, the exception was made in favour of

<sup>1793</sup> Opinion of Advocate General Trstenjak, 12 February 2009, C-5/08, *Infopaq International A/S v. Danske Dagblades Forening*, para. 140.

<sup>1794</sup> This raises the question as to who qualifies as a “journalist”, but this question falls without the scope of this study and it is far from certain that defining the term would be a good idea.

<sup>1795</sup> GUIBAULT, L. *et al.*, *Study on the implementation and effect in Member States’ laws of Directive 2001/29/EC on the harmonisation of certain aspects of copyright and related rights in the information society*, IViR, Amsterdam, 2007, p. 53.

<sup>1796</sup> GUIBAULT, L. *et al.*, *Study on the implementation and effect in Member States’ laws of Directive 2001/29/EC on the harmonisation of certain aspects of copyright and related rights in the information society*, IViR, Amsterdam, 2007, p. 53.

<sup>1797</sup> GUIBAULT, L. *et al.*, *idem*, p. 53-54, citing: OATES, J., “Old media wants new deal with search engines”, *The Register*, 1st February 2006, at [http://www.theregister.co.uk/2006/02/01/newspapers\\_go\\_for\\_google/](http://www.theregister.co.uk/2006/02/01/newspapers_go_for_google/)

the press, and a news aggregator does not have the same needs and objectives as a press organ (or organs of the same nature). An important difference between them is the fact that a news aggregator does not write or publish articles, it just borrows them and indexes them with automatic algorithms, with no – or minor – human intervention. News aggregators do not themselves always wish to have the status of press and to have to go by the duties attached to the press activity. With respect to the objective of the provision and the differences between news aggregators and the press, it is thus in our view justified to not assimilate them and prohibit news aggregation to benefit from the exception as it is currently drafted.

The uses by the bloggers and users of social media, who are not members of the press, could barely be covered by the exception. Given the aim of the exception, those natural persons may not invoke it. Besides, consider that they could benefit from the press review exception could render the quotation exception inoperative.

24. Finally, concerning the application of the **three-step test** to the offer of press clippings by a legal entity or a natural person to the general public, we refer to the considerations above about the offer of press clippings to employees or subscribers. In our opinion, the conclusions are identical. Those cases aim “certain special cases” but they may “conflict with a normal exploitation” of the work. Therefore, those uses of press clippings are not compatible with the three-step test. The same holds for press clippings by a natural person: one thing is to observe *ex post* that they are in practice and presently not facing many risks of being sued in court because the impact of their activity remains limited, another thing would be to exonerate them *ex ante* from any such risk by introducing a new exception.

#### IV. Practices in the selected Member States

25. The Terms of reference require examining whether the offer of press clippings in the three cases examined above has been assessed in a series of selected Member States.

The eleven selected Member States are: Germany, France, UK, Italy, Spain, Poland, Denmark, Hungary and Benelux.

This chapter summarizes the implementation of article 5(3)(c) in these countries. It draws the attention to recent judicial decisions, which may be relevant to one or several of the three cases.

26. Article 5(3)(c) has been **implemented** in the selected Member States in many different ways. The review of the implementation is not simple, notably because article 5(3)(c) contains two different exceptions in favour of the press with different conditions. Some Member States have implemented both exceptions, others did not implement the first exception for press review at all. All the selected Member States implemented the second part of article 5(3)(c) of the Directive about the reporting of current events, but this exception is not the object of this Study.

Among the selected Member States, five of them (a minority) implemented the press review exception with similar terms, that is to say: Germany, Hungary, Italy, the Netherlands and Poland.

The scope of the exception differs from jurisdiction to jurisdiction. For IViR, “Important variations exist in the way Member States have implemented the first part of article 5(3)(c), even though the text of the provision would seem to be rather explicit. Some Member States have failed to require the mention of the source or of the author’s name; others have attached the obligation to pay fair compensation; while others have included translations within the scope of the provision. Moreover, although courts are bound to interpret the provisions in their law in conformity with the text of the Directive, it is important to point out that important differences can still arise in the judicial interpretation of the provision throughout the



Member States.<sup>1798</sup> As the focus of this Study lies in the beneficiaries of the exception, we will not analyse how the other conditions of the exception have been implemented in the national legislation.

It is interesting to see that, among the selected Member States which implemented article 5(3)(c), some of them provided for an equitable remuneration of the right holders. This is the case in Germany (art. 49(1) of the Copyright Act)<sup>1799</sup> and in Poland (art. 25(1)(1)(b) of the Copyright Act).

27. Several national legislation of the selected Member States **did not implement** article 5(3)(c) of the Directive (or article 10*bis*(1) of the Berne Convention). Any making of press review of an original work in the sense of the exception, will thus in principle fall under the exclusive rights of the right holders. For those copyright laws, we must consider that there are against any offer of press clippings inside a company or an institution, without the right holders consent, unless they provide for a “national” exception in that sense, like in Denmark for internal uses within a company or an institution.

Amongst the selected Member States, Belgium,<sup>1800</sup> Denmark,<sup>1801</sup> France, Luxemburg,<sup>1802</sup> Spain and the United Kingdom did not implement the press review exception as such. However, those Member States usually offer the possibility to cite a work for purposes of review. They thus open the right to make press reviews, not through the conditions of article 5(3)(c) of the Directive (which is dedicated to the press), but through those of the quotation exception.

For example in Spain, the making of press clippings shall be deemed quotation, albeit subject to a specific regime and the reproduction of press clippings for commercial purposes is subject to an equitable compensation (art. 32.1, 2° of the Intellectual Property Act).<sup>1803</sup>

While the French Intellectual Property Code does not contain a provision similar to article 5(3)(c) of the Directive, it states that the author cannot prohibit press reviews (art. L. 122-5, 3°(b))<sup>1804</sup>.

The French courts have interpreted this article allowing press reviews quite restrictively.<sup>1805</sup> For the Supreme Court, a press review implies “a joint and comparative presentation of several commentaries from different journalists concerning a common theme or a same event.”<sup>1806</sup> The press review exception is thus reserved to press organs and focuses on one single subject. The press review does not cover the compilation of newspapers or periodicals articles on one or more topics by non-press organs, called in

<sup>1798</sup> GUIBAULT, L. *et al.*, *idem*, p. 53.

<sup>1799</sup> The provision precises that an equitable remuneration shall be paid “unless the reproduction, distribution and communication to the public is of short extracts of several commentaries or articles in the form of an overview”.

<sup>1800</sup> On the occasion of the implementation of the Directive, the Belgian legislator added to the traditional purposes of the quotation (criticism, polemic, education or scientific purposes), the possibility to cite a work for purposes of review. DUSOLLIER, S., “Le géant aux pieds d’argile: Google News et le droit d’auteur”, *Lamy*, 2007, n°26.

<sup>1801</sup> While Denmark did not implement the exception as such, we will see that it provided for a press review exception for internal uses.

<sup>1802</sup> In Luxembourg, the Government initially intended to implement the exception for press review, but finally considered that the wording of article 5(3)(c) of the Directive “would seriously impede the exploitation of information in the media sector” and was not retained in the final version of the Copyright Act. MANHAEVE, K. and SCHILTZ, T., in LINDNER, B., and SHAPIRO T., *Copyright in the Information Society. A guide to national implementation of the European directive*, Edward Elgar, UK and USA, 2011, p. 368, referring to *Doc. Parl.*, 5128-2, p. 6.

<sup>1803</sup> LEÓN, M. G., in LINDNER, B., and SHAPIRO T., *Copyright in the Information Society. A guide to national implementation of the European directive*, Edward Elgar, UK and USA, 2011, p. 521; XALABARDER, R., “Google News and Copyright”, in LOPEZ-TARRUELLA, A. (ed.), *Google and the Law. Empirical approaches to legal aspects of knowledge-economy business models*, Springer, The Netherlands, 2012, p. 140 and 142.

<sup>1804</sup> “Lorsque l’oeuvre a été divulguée, l’auteur ne peut interdire : (...) 3° Sous réserve que soient indiqués clairement le nom de l’auteur et la source : (...) b) Les revues de presse”.

<sup>1805</sup> GUIBAULT, L., “The Press Exception in the Dutch Copyright Act”, in HUGENHOLTZ, P.B., QUAEVLIEG, A.A., & VISSER, D.J.G., (eds.), *A Century of Dutch Copyright Law. Auteurswet 1912-2012*, Amsterdam, 2012, p. 472.

<sup>1806</sup> Cass. crim., 30 janvier 1978, *D.*, 1979, p. 583, cited by LUCAS, A. & LUCAS, H.-J., 3<sup>rd</sup> ed., Paris, Litec, 2010, p. 398.

France “panoramas de presse”, and subject to the authorisation of the authors (managed by the Centre français d’exploitation du droit de copie (CFC)).<sup>1807</sup>

For example, newspapers sued a website, which was displaying a chronological list of articles, with a short presentation, the title, the source, the first lines and a short summary of the article.<sup>1808</sup> The judges dismissed the exception for press review, because the list of articles were all related to different topics, there was no plurality of opinions on a same topic and a comparison of opinions. On the other side, the exception for short quotation has been accepted.

Similarly to France, Member States which have a restrictive interpretation of the press review exception are *a priori* against the making of press clippings inside a company or an organisation. Consequently, those countries will also not permit the offer of press review to employees (case A), clients (case B) or to the general public (case C).

28. In many Member States, the actors of the press clippings market have found **contractual solutions** to the selling of press clippings. Press clippings agencies have concluded deals with representatives of the newspaper publishers and in turn license users to copy extracts from newspapers and periodicals, and collect fees on behalf of authors and publishers. For example, Copiepresse, Mediargus and Reprocopy in Belgium, the Centre français d’exploitation du droit de copie (“CFC”) in France, the Copyright Licensing Agency (“CLA”) and the Newspaper Licensing Agency (“NLA”) in the United Kingdom.

In The Netherlands, to follow technological developments, media organisations have innovated in their contractual practices and found news ways of sharing news. An “experimental on-demand news fragments channel” has been launched by the Dutch Broadcasting Foundation (NOS), “where websites of newspapers and more general news websites can now add for free NOS video footage to their own content”.<sup>1809</sup>

Also in the Netherlands, “to facilitate the grant of licences and the payment of fair compensation by newspaper clipping services, a majority of Dutch newspaper publishers have joined in the new ‘Copyright Licentie- en Incassobureau PRO’ (CLIP) created under the auspices and with the support of the Dutch Publishers Association (NUV).<sup>1810</sup> CLIP collects on behalf of and distributes fees to publishers and freelance journalists who have entrusted it with the right to grant licences to suppliers of newspaper clipping services. The collective arrangement set out by CLIP governs the use of articles from daily and weekly newspapers and magazines by clipping services.”<sup>1811</sup>

After this general information about the implementation of article 5(3)(c) in the Member States, we will now examine the national legislations and case law regarding the three cases of offers of press clippings, as requested in the Terms of reference.

---

<sup>1807</sup> Case where a company making unauthorised electronic « panorama de presse » was condemned : Court of Appeal of Paris, 17 February 2006, *Vecteur Plus*, at [www.legalis.net](http://www.legalis.net).

<sup>1808</sup> District court of Nancy, 1<sup>st</sup> civ., 6 December 2010., *Lamy*, 2011/69, *Le Bien Public v. Dijonscope*.

<sup>1809</sup> GUIBAULT, L., “The Press Exception in the Dutch Copyright Act”, in HUGENHOLTZ, P.B., QUAEDVLIEG, A.A., & VISSER, D.J.G., (eds.), *A Century of Dutch Copyright Law. Auteurswet 1912-2012*, Amsterdam, 2012, p. 466 - 467. Author cites: ‘NOS deelt videocontent met dagbladen en nieuwssites’, 13 January 2012, available at: <http://over.nos.nl/voor-de-pers/nos-persberichten/detail/7>

<sup>1810</sup> Author cites: ‘CLIP stelt auteursrecht veilig’, 3 November 2008: <http://www.nuv.nl/nieuws/ejz-nieuws/clip-stelt-auteursrecht-veilig.11638.lynkx>

<sup>1811</sup> GUIBAULT, L., “The Press Exception in the Dutch Copyright Act”, in HUGENHOLTZ, P.B., QUAEDVLIEG, A.A., & VISSER, D.J.G., (eds.), *A Century of Dutch Copyright Law. Auteurswet 1912-2012*, Amsterdam, 2012, p. 466 - 467.

## A. The offer by an organisation to its employees

29. Among the selected Member States which implemented the press review exception, the Netherlands and Germany have produced case law about the offer of press clippings inside organisations. After having described those national court decisions, we will present the Danish provision in favour of the internal uses of press clippings.

### 1. The Netherlands

30. Article 15 of the Dutch Copyright Act authorises the use of works from a press media (written, radio, TV and internet press included) to another.

More specifically, article 15 permits the use of “news items, miscellaneous items or articles on current economic, political or religious topics or works of the same nature which have been published in a daily or weekly newspaper or weekly or other periodical, radio or television programme or other medium that has the same function”, “by a daily or weekly newspaper, a weekly or other periodical, a radio or television programme or other medium that has the same function”. The expression “of the same function” refers to news websites that are periodically renewed, emailed newsletters and news services via mobile phones.<sup>1812</sup>

31. In the landmark case “**Knipselkranten**” of 1995, the Dutch Supreme Court adopted a flexible interpretation of article 15 of the Dutch Copyright Act containing the press review exception.<sup>1813</sup> The Court said that the exception “also applied to the production of newspaper cuttings, including in cases where this only involved selection work by an institution that could not be regarded as a ‘press organ’ in the everyday sense of that term”<sup>1814</sup>. This solution did not however apply to digital press reviews, but only to print services.

The facts were the following: the Foundation for Reprography Rights (“Stichting Reprorecht”) sued the Association of Dutch Libraries and Reading Centres (“NBLC”) and the Province of North-Brabant because they did not have the consent of the right holders (through a licence) to reproduce and communicate press clippings to the employees of the Province.

The Supreme Court considered that article 10*bis* of the Berne Convention, which is the source of the Dutch article 15, reserved the definition of “the press” to the members of the Union. She turned to the parliamentary debate of article 15 to interpret the notion of press. The Explanatory Memorandum stated that press review services would fall under the scope of article 15.<sup>1815</sup> In conclusion, the Supreme Court decided that analogic press reviews services were allowed under the exception. This interpretation of the Dutch legislation differs from the other member States.<sup>1816</sup>

---

<sup>1812</sup> SPOOR, J., VERKADE, D., & VISSER, D., *Auteursrecht, naburige rechten en databankenrecht*, Kluwer, 3<sup>rd</sup> ed., 2011, p. 229.

<sup>1813</sup> Supreme Court, 10 November 1995, *AMI*, 1996, p. 55, *Stichting Reprorecht v. NBLC*, note QUAEDVLIEG, A.; *IER*, 1996, p. 20, note Hugenholtz, p. 28.

<sup>1814</sup> GUIBAULT, L., “The Press Exception in the Dutch Copyright Act”, in HUGENHOLTZ, P.B., QUAEDVLIEG, A.A., & VISSER, D.J.G., (eds.), *A Century of Dutch Copyright Law. Auteurswet 1912-2012*, Amsterdam, 2012, p. 462.

<sup>1815</sup> During the Parliamentary debates, the Ministry answered to a question alleging that press reviews cannot be considered as newspapers, that press reviews distributed by the public sector answer to all conditions of article 15. QUAEDVLIEG, A., « Les informations d’actualité en droit néerlandais », in LUCAS, A., SIRINELLI, P., and BENSAMOUN, A. (dir), *Les exceptions au droit d’auteur. Etat des lieux et perspectives dans l’Union européenne*, Dalloz, 2012, Paris, p. 124 - 125.

<sup>1816</sup> HUGENHOLTZ, B., “Chronicle of The Netherlands Dutch copyright law, 1990-1995”, *RIDA*, 1996, p. 176 at <http://www.ivir.nl/publications/hughholtz/PBHbk!.pdf> and QUAEDVLIEG, A., « Les informations d’actualité en droit néerlandais », in LUCAS, A., SIRINELLI, P., and BENSAMOUN, A. (dir), *Les exceptions au droit d’auteur. Etat des lieux et perspectives dans l’Union européenne*, Dalloz, 2012, Paris, p. 123 - 126.

This case met strong critiques from the doctrine, commentators reproached that the reciprocity on the ground of the exception had been neglected,<sup>1817</sup> they “feared that the economic interests of newspaper publishers would increasingly be put at risk because it basically encouraged second-comers to free ride on the creative efforts of others.”<sup>1818</sup> And “[w]ith the emergence of digital networked technology, the wind started to turn for the providers of newspaper clipping services”<sup>1819</sup>. In fact, as we will see below, the more recent case law is in disfavour of free internal press clippings.

32. In 2005, the District Court of The Hague had to deal with a case about internal scanning and communication of copies of press articles in ministries.<sup>1820</sup> Several **Dutch newspaper publishers** sued the **State** for copyright infringement. The Court judged that the making of electronic newspaper clippings was in contravention with the three-step test of the Directive. The uses of the electronic newspaper clippings conflicted with the normal exploitation of the newspapers and unreasonably prejudiced the legitimate interests of the publishers.<sup>1821</sup> The Court considered that because the digital press review practice does not comply with the three-step test, the exception could not apply.<sup>1822</sup>

33. In 2011, the **Dutch newspaper publishers** sued the **Province of Flevoland** because its employees were making and distributing in-house paper press clippings from Dutch newspapers.<sup>1823</sup> The rights on the articles were expressly reserved. The province of Flevoland based its defence on the “Knipselkranten” case (see paragraph 32 below). This unauthorized making of paper press clippings was judged to infringe copyright.

The parties did not dispute the fact that the province of Flevoland has to be considered as “press” or not. The question at stake was about the scope of the reservation rights and the interpretation of “news reports and miscellaneous reports”. On the contrary of the “Euroclip” case (see paragraph 40 below), the Court said that the fact that the province had no commercial interest by making the press clippings was not relevant. The relevant issue was the fact that the right holders were missing revenues when the province used articles without paying remuneration.<sup>1824</sup> For L. Guibault, “[t]his is a very interesting conclusion indeed, for Article 15 of the Copyright Act does not foresee the payment of fair compensation to the rights owners and no court has ever ruled exactly in this sense before. Of course, too strict a prohibition on the making of newspaper clippings would have risked receiving bad press because of its inevitable encroachment on the free flow of information.”<sup>1825</sup>

---

<sup>1817</sup> QUAEDVLIEG, A., « Les informations d'actualité en droit néerlandais », in LUCAS, A., SIRINELLI, P., and BENSAMOUN, A. (dir), *Les exceptions au droit d'auteur. Etat des lieux et perspectives dans l'Union européenne*, Dalloz, 2012, Paris, p. 125.

<sup>1818</sup> GUIBAULT, L., “The Press Exception in the Dutch Copyright Act”, in HUGENHOLTZ, P.B., QUAEDVLIEG, A.A., & VISSER, D.J.G., (eds.), *A Century of Dutch Copyright Law. Auteurswet 1912-2012*, Amsterdam, 2012, p. 462, citing: ALBERDINGK THIJM, C., “Fair use: het auteursrechtelijk evenwicht hersteld”, *AMI*, 1998/9, p. 145-153.

<sup>1819</sup> GUIBAULT, L., “The Press Exception in the Dutch Copyright Act”, in HUGENHOLTZ, P.B., QUAEDVLIEG, A.A., & VISSER, D.J.G., (eds.), *A Century of Dutch Copyright Law. Auteurswet 1912-2012*, Amsterdam, 2012, p. 463.

<sup>1820</sup> District Court, The Hague, 2 March 2005, case n°192880, LJN: AS 8778, Computerr., 2005, p. 143 note KOELMAN, K.J.

<sup>1821</sup> Critique about the manner the judge applied the three-step test: DUSOLLIER, S., « L'encadrement des exceptions au droit d'auteur par le test des trois étapes », *IRDI*, 2005, p. 213-223.

<sup>1822</sup> GUIBAULT, L., “The Press Exception in the Dutch Copyright Act”, in HUGENHOLTZ, P.B., QUAEDVLIEG, A.A., & VISSER, D.J.G., (eds.), *A Century of Dutch Copyright Law. Auteurswet 1912-2012*, Amsterdam, 2012, p. 464; HUGENHOLTZ, P. & SENFTLEBEN, R. F., *Fair use in Europe. in search of flexibilities*, IViR, Vrije Universiteit Amsterdam, Amsterdam, 2011, p. 19; QUAEDVLIEG, A.A., in LINDNER, B., and SHAPIRO T., *Copyright in the Information Society. A guide to national implementation of the European directive*, Edward Elgar, UK and USA, 2011, p. 414.

<sup>1823</sup> Court of Appeal of Leeuwarden, 26 July 2011, IEPT20110726, *AMI*, 2011-6, p. 232-235 (NDP v. Provincie Flevoland), note KOELMAN, K.J.

<sup>1824</sup> GUIBAULT, L., “Dutch press exception revisited”, *Kluwer Copyright Blog*, 9 August 2011, at <http://kluwercopyrightblog.com/2011/08/09/dutch-press-exception-revisited/>

<sup>1825</sup> GUIBAULT, L., “The Press Exception in the Dutch Copyright Act”, in HUGENHOLTZ, P.B., QUAEDVLIEG, A.A., & VISSER, D.J.G., (eds.), *A Century of Dutch Copyright Law. Auteurswet 1912-2012*, Amsterdam, 2012, p. 465.

## 2. Germany

34. Article 49(1) of the German Copyright Act authorises the reproduction, distribution and communication to the public of articles from newspapers concerning current political, economic or religious issues, provided that an equitable remuneration is paid (through collective rights societies). The use of short extracts of several commentaries or articles in the form of an overview is not subject to compensation.

35. This German exception allows for analogue press-clipping services, against the payment of an equitable remuneration paid. The question whether the exception covers electronic press-clippings was asked in 2002 to the German Federal Supreme Court, in the “**Elektronischer Pressespiegel**” case.<sup>1826</sup> According to the Supreme Court, the limitations permit in-house electronic press-clippings by a company or an administration. The case was concerning “the scanning and storing of press articles for internal e-mail communication in a private company”.<sup>1827</sup> The Supreme Court “limited the scope of the statutory exception to scans which the subscriber to the press-clipping service could systematically search, in order to ensure that the use-intensity of the copies legally made under the copyright limitation did not exceed what the historical legislature had intended to exempt from exclusive copyright control”<sup>1828</sup>.

In respect of those in-house press clippings, the German Federal Supreme Court decided that the limitation under German law that exempts digital in-house press-clippings services, which is combined with a statutory remuneration right, complied with article 5(3)(c). However, the Court did not address the problem that article 5(3)(c) only relates to reproductions made ‘by the press’ (in the Elektronischer Pressespiegel case the beneficiary was not a press company). To comply with article 49(1), the Court said that “(f)irst, only transmissions inside a company or governmental department (so-called in-house press reviews) are allowed. Second, the external articles may only be transmitted in graphic files or files in which the several articles are integrated as facsimile, for these formats allow just as little systematic searching possibilities in the transmitted documents as analogue documents do.”<sup>1829</sup>

“To overcome the problem of an outdated wording of § 49(1) that seemed to indicate the limitation’s confinement to press reviews on paper,<sup>1830</sup> the Court stated that, in view of new technical developments, a copyright limitation may be interpreted extensively.<sup>1831</sup> Taking these considerations as a starting point, the Court arrived at the conclusion that digital press reviews were permissible if articles were included in graphical format without offering additional functions, such as a text collection and an index. This extension of the analogue press review exception to the digital environment, the Court maintained, was in line with the three-step test<sup>1832, 1833</sup>.”

<sup>1826</sup> BGH, 11 July 2002, *GRUR*, 2002, p. 963; *Juristenzeitung*, 2003, p. 473, note DREIER; T. HOEREN, T. “Pressespiegel und das Urheberrecht”, *GRUR*, 2002, p. 1022; DREIER, T. “Regulating competition by way of copyright limitations and exceptions”, in TORREMANS, P., *Copyright Law. A handbook of contemporary research*, Edward Elgar, U.S.A., 2007, p. 246.

<sup>1827</sup> HUGENHOLTZ, P. & SENFTLEBEN, R. F., *Fair use in Europe. In search of flexibilities*, IViR, Vrije Universiteit Amsterdam, Amsterdam, 2011, p. 23.

<sup>1828</sup> DREIER, T. “Regulating competition by way of copyright limitations and exceptions”, in TORREMANS, P., *Copyright Law. A handbook of contemporary research*, Edward Elgar, U.S.A., 2007, p. 246.

<sup>1829</sup> GUIBAULT, L., “The Press Exception in the Dutch Copyright Act”, in HUGENHOLTZ, P.B., QUAEDVLIEG, A.A., & VISSER, D.J.G., (eds.), *A Century of Dutch Copyright Law. Auteurswet 1912-2012*, Amsterdam, 2012, p. 470 citing: SPOOR, J.H., “Elektronische knipselkranten in Duitsland”, 2003-1, *AMI*, p. 27; HOEREN, T., “Besprechung des BGH-Urteils „Elektronischer Pressespiegel””, *GRUR*, 2002, p. 1022; SPINDLER, G., “Die Archivierung elektronischer Pressespiegel”, *AfP*, 2006, p. 408.

<sup>1830</sup> Auhors refer to : § 49(1) of the German Copyright Act, as in force at that time, referred to “*ter.*”

<sup>1831</sup> Auhors refer to : See Bundesgerichtshof, *ibid.*, 966-966.

<sup>1832</sup> Auhors refer to : See Bundesgerichtshof, *ibid.*, 966-967. The Court referred to the three-step test of Article 5(5) ISD. The EC three-step test enshrined in this provision, however, does not deviate from the international three-step test.

<sup>1833</sup> HUGENHOLTZ, P. & SENFTLEBEN, R. F., *Fair use in Europe. In search of flexibilities*, IViR, Vrije Universiteit Amsterdam, Amsterdam, 2011, p. 24.

The Court said that the limitation also complies with article 5(5) as long as the national copyright law provides for compensating the right holders.<sup>1834</sup> "(T)he Court gave a further example of its flexible approach to the three-step test. It held that digital press reviews had to be deemed permissible under § 49(1) of the German Copyright Act just like their analogue counterparts, if the digital version – in terms of its functioning and potential for use – essentially corresponded to traditional analogue products."<sup>1835</sup>

### 3. Denmark

36. Denmark provided for, in article 14 of the Copyright Act, a limitation for public or private institutions, organisations and business enterprises, which reproduce descriptive articles (which is an additional condition), and other works for internal uses. The limitation provides for an extended collective licence (in article 50 of the Copyright Act). Article 14 reads as follows:

*(1) Public or private institutions, organisations and business enterprises may for internal use for the purpose of their activities by photocopying, etc., make or have copies made of descriptive articles in newspapers, magazines and collections, of brief excerpts of other published works of descriptive nature, of musical works and of illustrations reproduced in association with the text, provided the requirements regarding extended collective license according to section 50 have been met. Such copies may be used only for activities which are covered by the agreement presumed in section 50.*

*(2) If disputes arise on whether an organisation approved according to section 50(4) to make license agreements according to subsection (1), proposes unreasonable terms to such a license agreement, each party to the license agreement is entitled to bring the dispute before the Copyright License Tribunal cf. § 47. The Tribunal may lay down all the terms of the said license agreement, including terms relating to remuneration.*

The Danish Copyright Act has another peculiarity, it provides for a special treatment for press releases (art. 72):

*Press releases supplied under contract from foreign news agencies or from correspondents abroad, may not without the consent of the recipient be made available to the public through the press, the radio or in any other similar manner until after 12 hours after they have been made public in Denmark.*

#### B. The offer by a (commercial) entity to its subscribers

37. We did not find legislation or case law in the selected Member States *allowing* the offer of press clippings by an entity (commercial or not) to its subscribers or clients.

You will find here some case law *prohibiting* the offer press clippings to subscribers without the consent of the right holders.

It is probably worth noting that representatives from this sector do recognize the importance of copyright and the need to conclude agreements with publishers<sup>1836</sup>.

---

<sup>1834</sup> DREIER, T. & HUGENHOLTZ B., (eds), "Concise European Copyright Law", Kluwer, The Netherlands, 2006, p. 379 and WALTER, M. W. & VON LEWINSKI, S. (eds), *European Copyright Law. A commentary*, Oxford University Press, U.K., 2010, p. 1047, n°11.5.55. The last authors cite : VON LEWINSKI, S., "News from Germany", *RIDA*, 2005, 206, 261; KATZENBERGER, P., "Elektronische Pressespiegel aus der Sicht des Urheberrechtlichen Konventionsrechts", *GRUR Int*, 2004, 739, 743 (critical view of this decision in the light of the three-step test).

<sup>1835</sup> HUGENHOLTZ, P. & SENFTLEBEN, R. F., *Fair use in Europe. in search of flexibilities*, IViR, Vrije Universiteit Amsterdam, Amsterdam, 2011, p. 23.

<sup>1836</sup> FIBEP (Federation Internationale des Bureaux d'Extraits de Presse) is, according to its own website, "the world's largest association for media intelligence and communications insight. (...)". The current membership holds close to 96 members in 44

## 1. The Netherlands

38. In 1995, the District Court of The Hague<sup>1837</sup> refused to apply the Dutch exception for press review to a CD-ROM containing reviews "clipped" from Dutch newspapers (**LiteROM**).<sup>1838</sup>

39. In the case "**Euroclip**" of 2004, the District Court of Amsterdam took distance from the "Knipselkranten" case (see paragraph 32 above). "Euroclip offered its clients a service of digital newspaper clippings tailored to their individual needs – scanning and sending clients a selection of articles on specific topics."<sup>1839</sup> Newspaper publishers introduced proceedings against this press clipping service. The Court "rejected the defendant's argument based on the press exception. According to the court, Euroclip's service was not eligible for the press exception because of its commercial purpose. The court ruled that given the substantial commercial interests of the defendant, the newspaper clipping service could not qualify as publications issued for the promotion of the free flow of information. In this light, the interests of the defendant did not weigh more than those of the plaintiffs to protect their copyright. This judgment gave rise to critique: while commentators agreed with its outcome, they strongly disapproved the motives. Newspapers and periodicals are also published for commercial purposes; and these are precisely the media covered by Article 15 of the Act and the underlying Article 10bis of the Berne Convention.<sup>1840</sup> The court's argument, if followed, would have excluded the vast majority of newspapers and periodicals from the application of the press exception."<sup>1841</sup>

## 2. Italy

40. The Italian Law "expressly prohibits the systematic reproduction of published or broadcast information or news, with gainful intent, by newspapers or other periodicals or by broadcasting organizations"<sup>1842</sup>.

About article 65 of the Italian Copyright Act, the Supreme Court "confirms that this exception does not cover press reviews made for gainful intent, such as those produced by specialized firms on distinct topics or themes on behalf of their customers"<sup>1843</sup>.

---

countries. The Federation states the following on its website: "*FIBEP respects the requirement of our media partners and other rights owners to protect their copyright in published news stories. FIBEP recognises the investment our media partners make in gathering, writing and editing news and information for presentation to the public. We expect to work harmoniously with rights owners to ensure we are able to meet our customers' needs and deliver content to them in a fair and ethical way. By the same token, we look to rights owners to acknowledge the added value we create by searching, selecting, sorting, presenting and evaluating articles of interest to our customers*".

<sup>1837</sup> District Court of The Hague, 3 May 1995, AMI 1995, 116 (LiteROM).

<sup>1838</sup> HUGENHOLTZ, B., "Chronicle of The Netherlands Dutch copyright law, 1990-1995", *RIDA*, 1996, p. 176 at <http://www.ivir.nl/publications/hughenholtz/PBHbk!.pdf>

<sup>1839</sup> GUIBAULT, L., "The Press Exception in the Dutch Copyright Act", in HUGENHOLTZ, P.B., QUAEDVLIEG, A.A., & VISSER, D.J.G., (eds.), *A Century of Dutch Copyright Law. Auteurswet 1912-2012*, Amsterdam, 2012, p. 463.

<sup>1840</sup> District Court of Amsterdam, 4 September 2002 AMI 2003-1, p. 22 (Uitgevers en Freelancers v. Knipselkranten), with annotation from J.H. Spoor, p. 26.

<sup>1841</sup> GUIBAULT, L., "The Press Exception in the Dutch Copyright Act", in HUGENHOLTZ, P.B., QUAEDVLIEG, A.A., & VISSER, D.J.G., (eds.), *A Century of Dutch Copyright Law. Auteurswet 1912-2012*, Amsterdam, 2012, p. 463. Authors criticizing the "Euroclip" arrest: SPOOR, J., VERKADE, D., & VISSER, D., *Auteursrecht, naburige rechten en databankenrecht*, Kluwer, 3<sup>rd</sup> ed., 2011, p. 230.

<sup>1842</sup> XALABARDER, R., "Google News and Copyright", in LOPEZ-TARRUELLA, A. (ed.), *Google and the Law. Empirical approaches to legal aspects of knowledge-economy business models*, Springer, The Netherlands, 2012, p. 145, note 156.

<sup>1843</sup> Corte di cassazione, 20 September 2006, n°20410, ERCOLANI, S., in LINDNER, B., and SHAPIRO T., *Copyright in the Information Society. A guide to national implementation of the European directive*, Edward Elgar, UK and USA, 2011, p. 308, note 25.

### 3. Germany

41. In Germany, “an appeal court ruled that Article 49(1) did not permit the making of *subscription press-clipping services*.”<sup>1844</sup>

### 4. Denmark

42. As we already said, the Court of justice has not been interrogated on the interpretation of article 5(3)(c) of the Directive in its landmark cases Infopaq, involving a media monitoring company. However, both arrests mentioned the article under the title “Legal context. European Union Law”, just as the opinion of the Advocate General.

It seems that Denmark did not include the first part of the exception of article 5(3)(c) of Directive 2001/29 as such in its national legislation. But it provided for other exceptions in favour of the internal uses of works of descriptive nature, as we already saw above.

After eight years of dispute, the Danish Supreme Court rendered its final judgement in March 2013 in the Infopaq case.<sup>1845</sup> The Supreme Court asked twice for a prejudicial decision on questions regarding acts of reproduction (art. 2 of the Directive) of parts of news articles and of acts of temporary reproduction (exception of art. 5(1) of the Directive). Based on the prejudicial answers, the Supreme Court decided in favour of the Danske Dagblades Forening. The services of Infopaq occasionally involve reproduction of texts protected by copyright, which are not covered by the exemptions in article 5(1) of the Directive. They are thus infringing copyright.

### 5. United Kingdom

43. An important case coming from the United Kingdom is now before the Court of justice.<sup>1846</sup> It opposes **Meltwater**, a media monitoring company (similar to Infopaq), to the Newspaper Licensing Agency (“NLA”), a licensing agency that represents British newspapers.<sup>1847</sup> The preliminary questions associated to this case however are not linked to interpretation of article 5(3)(c), but rather to the act of browsing and whether it is, as such, covered by Article 5(1) (transient/temporary copies).

Meltwater monitors media websites to identify articles that interest its clients. It sends emails to its clients with a link to the articles, their headlines, the opening words and an extract of the articles. The clients can also access to the monitoring reports through Meltwater’s website.

The United Kingdom did not implement article 5(3)(c) for press review, this case is thus not directly relevant for the cases of this Study. However, the Copyright, Designs and Patents Act provides for an exception for quotation for the purpose of review (art. 30(1)). Press reviews, which do not meet the conditions set forth in the quotation exception, fall under the exclusive rights of the authors.

Following the decision in the Belgian Google v. Copiepresse case (see paragraph 53 below), the lower court and the Court of Appeal decided that there was a lack of critical analysis necessary to partake in review. The methods of Meltwater and the intention of the end-users to view the articles were not seen to

---

<sup>1844</sup> XALABARDER, R., “Google News and Copyright”, in LOPEZ-TARRUELLA, A. (ed.), *Google and the Law. Empirical approaches to legal aspects of knowledge-economy business models*, Springer, The Netherlands, 2012, p. 145, note 157. Citing LÓPEZ MAZA, S., “Las revistas de prensa en el entorno digital. Los supuestos de “press clipping””, *Revista Pe. i.*, 30, 2008, p. 69.

<sup>1845</sup> Højesterets Dom, 13 March 2013, 97/2007, Infopaq v. Danske Dagblades Forening, at <http://www.domstol.dk/hojesteret/nyheder/Afgorelser/Documents/97-2007.pdf>

<sup>1846</sup> Reference for a preliminary ruling from Supreme Court of the United Kingdom made on 27 June 2013 (Public Relations Consultants Association v. The Newspaper Licensing Agency), case C-360/13.

<sup>1847</sup> High Court of Justice, Chancery Division, 26 November 2010, EWHC 3099 (Ch), *Newspaper Licensing Agency v. Meltwater Holding*; Court of Appeal, Civil Division, 27 July 2011, EWCA Civ 890, *Newspaper Licensing Agency v. Meltwater Holding* and Supreme Court, 17 April 2013, UKSC 18, *Public Relations Consultants Association v. Newspaper Licensing Agency*.



be for the purpose of reviewing (nor criticising) the works. Besides, the Court of Appeal affirmed that the uses by the clients did not meet the conditions for reporting current events.<sup>1848</sup>

To avoid infringing copyright, Meltwater had to obtain a license from NLA, what it did. But Meltwater refused to purchase an “end-user” licence, for the uses done by its subscribers.<sup>1849</sup> The question at stake is thus whether Meltwater’s clients need a license to receive the monitoring service if the service is only available on Meltwater’s website. This question of the mere viewing (or “browsing”) of contents on the internet is fundamental for the working of the internet and the protection of copyright.<sup>1850</sup> The Supreme Court decided to refer the case to the Court of justice for a preliminary ruling.

### C. The offer by any legal entity or natural person to the general public

44. In general, national provisions implementing article 5(3)(c) of the Directive do not allow the offer of press clippings to the general public. The use of press review is, in the most “permissive” cases, reserved to the press or organisations that fulfil the same function, as in the Netherlands or Spain.

45. We did not find any national provision implementing article 5(3)(c) or any national case law allowing the use of the press review exception to bloggers or other individuals publishing content on internet (websites, social networks...), while they are not journalists or qualified as the “press”. In accordance with the Berlin Revision Conference of 1908, the freedom to reproduce news items is restricted to newspapers and does not apply to individuals (see paragraph 6 above). This goes in favour of the exclusion of natural persons (except journalists) from the benefit of the exception.

Several cases in The Netherlands tried to apply (but in vain) the exception of article 15 of the Copyright Act to websites, through the possibility to apply the exception, not only to “daily or weekly newspaper or weekly or other periodical, radio or television programme”, but also to “other medium that has the same function” (art. 15, 1, 1°).

In the Spanish Copyright Act, “works and articles on current events” disseminated by the communication media may be reproduced, distributed and communicated to the public by “any other media of the same type”, subject to compensation, unless the authors has opposed to it (art. 33.1).<sup>1851</sup> The studies and articles on current events include those disseminated online, as well as in any other format.<sup>1852</sup> The expression “another media of the same type” covers media that conveyed the original news (Google News is thus excluded).<sup>1853</sup> We did not find case law trying to apply the exception to non-press entities or journalists, like bloggers.

46. Search engines or news aggregators do not benefit from the exception and either are infringing or have negotiated with the right holders. However, a new German law now regulates the relationships between press publishers and search engines.

---

<sup>1848</sup> STANGANELLI, M., “Spreading the news online: a fine balance of copyright and freedom of expression in news aggregation”, *EIPR*, 2012/11, p. 750.

<sup>1849</sup> SMITH, J. & MONTAGNON R., “The Supreme Court’s opinion on browsing: Public Relations Consultants Association v. Newspaper Licensing Agency”, *EIPR*, 2013/8, p. 478; XALABARDER, R., “Google News and Copyright”, in LOPEZ-TARRUELLA, A. (ed.), *Google and the Law. Empirical approaches to legal aspects of knowledge-economy business models*, Springer, The Netherlands, 2012, p. 125, note 64.

<sup>1850</sup> SMITH, J. & MONTAGNON R., “The Supreme Court’s opinion on browsing: Public Relations Consultants Association v. Newspaper Licensing Agency”, *EIPR*, 2013/8, p. 477-481.

<sup>1851</sup> XALABARDER, R., “Google News and Copyright”, in LOPEZ-TARRUELLA, A. (ed.), *Google and the Law. Empirical approaches to legal aspects of knowledge-economy business models*, Springer, The Netherlands, 2012, p. 145, note 156.

<sup>1852</sup> XALABARDER, R., *idem*.

<sup>1853</sup> XALABARDER, R., *idem*.

For R. Xalabarder who analysed the question in details, “news aggregation activities do not benefit from any specific statutory limitation and can hardly fit in the existing ones in favour of press summaries (...); Obstacles being diverse and varying according to the interpretation of the statutory language.”<sup>1854</sup>

## 1. The Netherlands

47. Five years after the “Knipselkranten” case of 1995 (see paragraph 32 above), the District Court of Rotterdam applied the press review exception to an online press review service.<sup>1855</sup>

In this case called “Eureka”, “several newspaper publishers brought action against the makers of a website, www.kranten.com, which presented a selection of news items and links to articles from the plaintiffs’ newspapers. The defendant’s website contained the names of the plaintiffs’ national newspapers, accompanied by a list, updated daily, of titles of news items and articles that appeared on the websites of the respective newspapers. When clicking on the titles or the lists, the user was directly linked to the corresponding news item or article on the newspaper’s website, thereby bypassing the newspaper’s respective homepage and advertisements. The plaintiffs argued that the defendant’s activities constituted an infringement of their copyright in the articles and of their *sui generis* right in the database, as well as an act of unfair competition. The court rejected all claims. Assuming that titles and lists were copyrightable subject matter, the court held that the defendant, Eureka, qualified as a press organization, the press reviews of which were covered by the exemption of Article 15 of the Act”<sup>1856</sup>.

48. More recently, some case law tried to let several websites benefit from the exception for press review, invoking the application to “other medium fulfilling the same purpose”.

The District Court of Dordrecht<sup>1857</sup> considered that a website using news articles could not be said to have the same function as a daily or weekly newspaper, but rather one of archive (the articles were stored for years on the website).<sup>1858</sup> In the same sense, the benefit of the exception was denied to a website that “did not have as primary goal to bring daily news on various topics, but rather, as the defendants themselves asserted, to offer a platform where anyone can post his own story for free. Information could be found on the website on product testing, hostels, or travel insurance. Only a small section of the website pertained to news and the exception of Article 15 of the Copyright Act could therefore find no application.”<sup>1859</sup> Finally, about a website of which the purpose and main objective was not to generate news, the District Court of Amsterdam concluded that “(t)he fact that on the website (some) news is generated did not mean that the site could therefore be counted as ‘the media’. Nor did the fact that defendant wrote articles on www.nuijij.nl and any other digital newspapers entail that the site was therefore a press organization. This meant that the first condition was not met and the exception was therefore not applicable.”<sup>1860</sup>

---

<sup>1854</sup> XALABARDER, R., *idem*, p. 164.

<sup>1855</sup> District Court of Rotterdam, 22 August 2000, *AMI*, 2000/10, p. 205 (Kranten. com). GUIBAULT, L., “The Press Exception in the Dutch Copyright Act”, in HUGENHOLTZ, P.B., QUAEDVLIEG, A.A., & VISSER, D.J.G., (eds.), *A Century of Dutch Copyright Law. Auteurswet 1912-2012*, Amsterdam, 2012, p. 462 – 463.

<sup>1856</sup> GUIBAULT, L., “The Press Exception in the Dutch Copyright Act”, in HUGENHOLTZ, P.B., QUAEDVLIEG, A.A., & VISSER, D.J.G., (eds.), *A Century of Dutch Copyright Law. Auteurswet 1912-2012*, Amsterdam, 2012, p. 463.

<sup>1857</sup> District Court of Dordrecht, 20 July 2011, IEPT20110720 (Cozzmoss B.V. v. BVFP).

<sup>1858</sup> GUIBAULT, L., “The Press Exception in the Dutch Copyright Act”, in HUGENHOLTZ, P.B., QUAEDVLIEG, A.A., & VISSER, D.J.G., (eds.), *A Century of Dutch Copyright Law. Auteurswet 1912-2012*, Amsterdam, 2012, p. 461.

<sup>1859</sup> GUIBAULT, L., *idem*, citing District Court of Breda, 14 September 2011, LJN: BT2326 (Cozzmoss v. Weblication); the District Court of Breda, kanton Tilburg, came to a similar conclusion in a similar case of 29 June 2011 (Cozzmoss B.V. v. Richards B.V.), IEPT20110629.

<sup>1860</sup> GUIBAULT, L., *idem*, p. 461 – 462, citing: District Court of Amsterdam, 17 August 2011 (cozzmoss B.V.), IEPT20110817,.

The District Court of Amsterdam judged that a media company that runs a news website (“GeenStijl”) could benefit from the exception, because the reproduction of an interview on its website could qualify as a reproduction made by another medium that fulfils the same function.<sup>1861</sup>

49. Finally, we note that in the Netherlands newspapers are protected as such by article 10(1)<sup>1</sup> of the Copyright Act. All writings are protected even if there are not original; this is the so-called “*Geschriftenbescherming*”, a sort of neighbouring right for the publishers.

A bill abolishing this protection of non-original writings has been proposed in February 2013.<sup>1862</sup>

It is interesting to see that this draft legislation is in opposition with the so-called “Google Lex” in Germany (see below).

## 2. Germany

50. On March 1, 2013, Germany amended its Copyright Act to deal with the management of copyright content by search engines and news aggregators.<sup>1863</sup> The new articles (new sections 87f and 87g of the Urheberrechtsgesetz) create a neighbouring right for press publishers to improve the protection of press products on the Internet.<sup>1864</sup> The main intention of this change is to limit the free use of news content by search engines and news aggregators.<sup>1865</sup> This amendment of the copyright act is also known as “Leistungsschutzrecht für Presseverlage”, the “Lex Google” or the “Google Tax” law.

This law came under much pressure.<sup>1866</sup>

Search engines and news aggregators can provide access to content from newspapers after having paid a licence fee.<sup>1867</sup>

In reaction to this law, Google announced that it would change its system to “opt-in” in Germany, instead of the “opt-out”, to avoid copyright fees.<sup>1868</sup> The switch was expected on 1 August 2013, the same date as the entering into effect of the amendment of the Copyright Act.

However, many German news publishers declared that they will still opt-in in Google News.<sup>1869</sup>

---

<sup>1861</sup> District Court of Amsterdam, 12 May 2010, IEPT20100512 (Nijmeegse Stadskrant v. Geen Stijl), cited by GUIBAULT, L., *idem*, p. 461.

<sup>1862</sup> HUGENHOLTZ, B., “Goodbye, Geschriftenbescherming!”, 6 March 2013, at <http://kluwercopyrightblog.com/2013/03/06/goodbye-geschriftenbescherming/> available at <http://www.rijksoverheid.nl/documenten-en-publicaties/wetsvoorstellen/2013/06/27/wetsvoorstel-afschaffing-geschriftenbescherming> and <http://www.internetconsultatie.nl/geschriften>

<sup>1863</sup> Bundesanzeiger website: [http://www.bgbl.de/Xaver/start.xav?startbk=Bundesanzeiger\\_BGBl&jumpTo=bgbl113s1161.pdf#\\_Bundesanzeiger\\_BGBl\\_%2F%2F%5B%40attr\\_id%3D%2Fbgbl113s1161.pdf%5D\\_1379341204148](http://www.bgbl.de/Xaver/start.xav?startbk=Bundesanzeiger_BGBl&jumpTo=bgbl113s1161.pdf#_Bundesanzeiger_BGBl_%2F%2F%5B%40attr_id%3D%2Fbgbl113s1161.pdf%5D_1379341204148)

<sup>1864</sup> BARABASH, I., “Ancillary copyright for publishers: the end of search engines and news aggregators in Germany?”, *EIPR*, 2031, issue 5, p. 243 – 245.

<sup>1865</sup> WESTKAMP, G., “The new German publisher’s right – a violation of European Law? A comment”, *Queen Mary Jour.*, 2013, vol. 3, issue 3, p. 241-250.

<sup>1866</sup> WESTKAMP, G., “The new German publisher’s right – a violation of European Law? A comment”, *Queen Mary Jour.*, 2013, vol. 3, issue 3, p. 241. See the opinion of the Max-Planck-Institut on the draft legislation for an amendment to the Copyright Act: [http://www.ip.mpg.de/files/pdf2/Stellungnahme\\_zum\\_Leistungsschutzrecht\\_fuer\\_Verleger.pdf](http://www.ip.mpg.de/files/pdf2/Stellungnahme_zum_Leistungsschutzrecht_fuer_Verleger.pdf)

<sup>1867</sup> MONTANARI, A., ““Lex Google”: Copyright Law and Internet Providers – Future Enemies or Allies”, *EIPR*, 2013, issue 8, p. 433.

<sup>1868</sup> <http://google-produkte.blogspot.de/search/label/Google%20News>

<sup>1869</sup> WESTKAMP, G., “The new German publisher’s right – a violation of European Law? A comment”, *Queen Mary Jour.*, 2013, vol. 3, issue 3, p. 241-250.

The rights granted to publishers include the making available of press products or parts thereof for commercial purposes. “Where the press product was made in (not necessarily ‘for’) a corporate entity, the owner of such legal entity is deemed the owner of the right. The term ‘press product’ is further defined. It encompasses, broadly, the ‘technical-editorial’ fixation of journalistic contributions, provided these contributions are published under an existing journal or newspaper title that is published periodically.”<sup>1870</sup>

### 3. France

51. In France, following the German example, legislative initiatives were launched in 2012 to create a neighbouring right for press organisations. A press lobby IPG (“Information politique et générale”, representing media companies and newspapers) wrote a draft legislation providing for an equitable compensation, in exchange for the right to make hyperlinks to the websites of press organisations.

After months of negotiations, a settlement was found on 1<sup>st</sup> February 2013 with Google. First, publishers will have “attractive conditions” to use the platforms of Google. Secondly, Google will create a fund for innovation in the online press (funded 60 millions of euros). The project of legislation was thus abandoned.<sup>1871</sup>

### 4. Belgium

52. As we already said, legislation and case law of the selected Member States always require the consent of the right holders to offer press clippings to the general public.

We will mention here the famous Belgian Copiepresse case regarding Google News.

During six years, publishers and authors’ collecting rights societies on one side, and Google Inc., on the other side, fought about the reuse by Google of content (titles, headlines, images, etc.) in its Google News service.

The Belgian exception contained in article 22 § 1, 1° of the Copyright Act did not implement the exception for press review, but well the exception for news reporting (or report of current events), contained in the second part of article 5(3)(c) of the Directive. Nevertheless, Google asked the Court of appeal of Brussels to apply this exception for news reporting to the news aggregating website.<sup>1872</sup> For the Court, both services at stake in the case, Google News and the cache function, amount to unauthorized reproductions, which do not benefit from any exception and furthermore infringes the three-step test.

The Court refused to apply the exception of article 22, § 1, 1° to Google News. The Court explained that the aim of article 22, § 1, 1° « was not to extend the quotation right, but to include an exception in favour of the information media that do not have the time to ask the author’s authorisation. »<sup>1873</sup> The Court concludes that the article must be interpreted restrictively and can only apply to cases where, because of a « need of a rapid information », no authorisation could be asked. Since the articles of Google News stay 30 days on the website, the exception can not apply.

---

<sup>1870</sup> WESTKAMP, G., “The new German publisher’s right – a violation of European Law? A comment”, *Queen Mary Jour.*, 2013, vol. 3, issue 3, p. 242-243..

<sup>1871</sup> PHÉLIP, O., “Google et la presse française: un accord de “raison””, 2 February 2013, at [http://www.huffingtonpost.fr/olivia-phelip/accord-google-presse\\_b\\_2613994.html](http://www.huffingtonpost.fr/olivia-phelip/accord-google-presse_b_2613994.html); COSTES, L., « Accord à l’arraché entre Google et les éditeurs de presse français », *Lamy*, 2013/90, p. 97.

<sup>1872</sup> Bruxelles (9<sup>e</sup> ch.), 5 May 2011, *RDTI*, 44/2011, obs.

, p. 48.

<sup>1873</sup> Bruxelles (9<sup>e</sup> ch.), 5 May 2011, *RDTI*, 44/2011, obs.

, p. 48, point 37.

In first instance, the judge highlighted that Google did not make any comment of the current events, it just collects titles and articles by themes. For the judge, the exception can only work – as for the quotation exception – if the protected works are the accessory of a report and not its principal object.<sup>1874</sup>

The Court of appeal also said that Google cannot pretend that it can materially not obtain the consent of the right holders to reproduce abstracts of news articles in Google News. Since collecting societies representing newspapers and authors in Belgium are entitled to conclude general contracts with the users for the exploitation of copyrighted works, Google can do the same to exploit press clippings in Google News.

In December 2012, the parties finally settled the case.

53. Lastly, in 2008, one should mention that Copiepresse, which manages the copyright of the French and German speaking newspapers publishers, one of the applicants in the other Copiepresse case seen below, sued the European Commission (Joint Research Centre Internal and External Communication Unit) about a website which monitors press articles (“Europe Media Monitor”, <http://press.jrc.it> and <http://emm.jrc.it>). Copiepresse invoked infringements to the copyright of its members both in proceeding on the merits and in injunction proceedings before Belgian courts.

Both judges declined jurisdiction in the proceedings, on the ground of article 235 and 288 (2) of the European Economic Community Treaty (now articles 268 and 340 of the Treaty on the Functioning of the European Union). Following their interpretation, the claims of Copiepresse had to be filed in front of the CJEU, because the CJEU is exclusively competent for the repairing of damages resulting from the extra-contractual liability of the European institutions.

Copiepresse appealed the decisions, and the cases were joined by the Court of appeal of Brussels. On 17 May 2013, the Court of appeal of Brussels rejected the appeals on the same basis as the judges of first instance. Since the Court declined its jurisdiction, it just analyses the procedure provision on its competence and did not discuss the substantive questions (and even less the possible exceptions the defendant could invoke). We thus need to wait for a possible action of Copiepresse in front of the CJEU.

## V. Conclusions

54. As we have seen, the exception on press review which can benefit “the press” has not been implemented in all Member States and, when it has been implemented, it has not always been implemented in a similar way. The resulting situation is a remaining absence of harmonization of this exception.

This unavoidably creates difficulties for users who wish to produce or reproduce press clippings without infringing copyright, particularly when the clippings originate from newspapers originating from different Member States.

Initially, it was probably so that an important part of users was only interested in press clippings originating from local (*i.e.* from their own jurisdiction’s) newspapers and more marginally from newspapers from other Member States, and that only a smaller part of users was willing to receive press clippings taken from newspapers of other Member States; it is probable that the bigger users will in many cases be larger organizations, with more resources and possibilities to investigate how to obtain authorizations covering the Member States from which they wish to receive information *via* press clippings and press reviews. However, with the development of Web aggregators, this might not hold true anymore since many individuals (and companies) will *e.g.* go to Google News’s portal, including sometimes for commercial purposes.

---

<sup>1874</sup> Pres. Civ., Bruxelles, 13 February 2007, *A&M*, 2007/1-2, obs. VOORHOOF, D., « Slecht nieuws voor Google News », p. 116.

In the three scenarios that we were asked to examine, our view is that none of them falls under the exception of article 5(3)(c) of the Directive, except of course for the legal entities or natural persons, which qualify as being part of the “press”, which has to be interpreted restrictively. Similarly, the national implementations of article 5(3)(c) do not permit any of the three cases we examined, with the exception of in-house press-clippings in Denmark (extended collective license) and in Germany under certain conditions. Besides, new German provisions allow news aggregators to reuse news items, after having paid a licence fee.

The consequence is thus that, in each of the cases examined, except in the situations just mentioned, **authorizations must be obtained from the rightholders on the news items.**

**This does not, in our view, have to be regretted:**

- the fact that enterprises or institutions wishing to have press reviews distributed internally to their employees need to obtain licences from rightholders to do so unarguably entails a price to be paid for, but the added-value and the competitive advantage which the making available of such press information does give to these companies represents an asset for which these enterprises or institutions should be ready to pay a price;
- press clipping companies which base their entire business model on the distribution (in print or more and more often in electronic formats) to their clients on the basis of a paid subscription do fulfill a useful role in society, for it is certain that their clients would in many cases not have the resources to do such research work themselves or the means (nor the will) to subscribe to a whole range of newspapers and periodicals. But since these publications do constitute the raw materials from which the press clipping companies derive their benefits, it does not appear illogical that they also pay a price for the possibility to offer such services to their clients;
- finally, news aggregators, like press clipping companies, certainly do contribute to the dissemination of press information and to a better informed society at large, but it is important to remember that they do so for a commercial purpose, they derive revenues therefrom and they do not themselves create any additional content; there also, it is not abnormal that, by application of copyright rules, they have to obtain licences from the rightholders to be able to do so<sup>1875</sup>.

Furthermore, enlarging the scope of the exception to cover any of these three situations would, we think, very unlikely pass the three step test. Those uses would certainly conflict with a normal exploitation of the work within the meaning of the second condition of article 5(5) of the Directive (and of the three-step test “family”). Any enlargement would indeed undoubtedly have significant negative financial repercussions for the existing press. As far as natural persons (such as bloggers) are concerned, because the impact of their activity is less important, they are less likely to come under scrutiny of rightholders and be sued in court and they can in certain cases rely on some other exceptions (quotation, parody); in other cases, allowing them to copy/paste news items on their blogs/websites by providing for an exception would also, in our view, be against the three step test.

It is also important to recall that many concrete solutions (licenses) exist in Member States and that no market failure seems to be deplored.

For the time being, the written press still plays an important role in democratic societies. The emergence of the Internet has confronted the written press with difficult challenges for years. It is trying to find new business models to adapt to the new situation created by the development of the Web but it is a well-known fact that the traditional written press has suffered and is suffering from the competition of the Internet, that a number of titles have disappeared or are struggling to survive. New “pure players” web press companies are emerging but are also in search of feasible and sustainable business models. The

---

<sup>1875</sup> TRIAILLE, J.P., “Copiepresse vs. Google”, *RDTI*, 2007/1.

reasons for this critical situation are mainly the downturn in advertising expenditures and to a lesser extent the decline in readership, falling cover sales and subscriptions.

Enlarging the press review exception to any other beneficiary than “the press” would make the existing situation more difficult from a financial point of view for the existing press (print or Web-based). A large exception could a priori be seen as being of benefit to the society at large, because it would facilitate the free flow of information. But by ignoring copyright on the reuse of news items, *i.e.* the raw material of media monitoring agencies and news aggregators, it would significantly undermine one of the revenue streams of the press, which is already struggling in the digital environment, and would thus eventually be detrimental rather than beneficial to the information society and in general to access to information. An economic analysis of the damages which would thereby be caused to the press would help in this debate on the right balance to find between creators of content and second-users.

The existing print press may have taken some time (and still be somewhat reluctant) to grant licences for the reuse of its contents by companies (for internal use) or by press clipping agencies and news aggregators. But one may observe that licences are progressively available, that more and more deals are concluded between the press and *e.g.* news aggregators that newspapers collectively have been able to resort to court and obtain injunctions against illicit uses of their contents – which has, in turn, brought news aggregators (and search engines) to the table of negotiations. This does not lead us to conclude that the exception should be enlarged in any manner.

Uncertainties and difficulties do remain, due to the fact that newspapers are in certain countries not organized collectively to grant licences and to the fact that what “the press” (and by the same token what “a journalist”) means is not always clear (so that borderline situations will unavoidably exist regarding the beneficiaries of the exception). But the first difficulty (absence of representative organizations granting licences for a catalogue of newspapers) is evolving and it is our view that it evolves in the right direction (even if this may still take some time); and as far as defining what “the press” means, there are many obstacles (and possibly dangers) to a rigid definition, so that it is very uncertain that a legal definition would be a welcome development. A case-by-case approach and an assessment by courts in accordance with the factual circumstances of each case is most probably a safer option.

One may however regret that the exception is implemented in different manners and/or not at all in Member States and wish that the situation evolves towards a more harmonized playing field. As for a number of the other exceptions in the InfoSoc Directive, a compulsory exception would make sense and bring clarity and more legal certainty to the picture, which is something which users are entitled to. It may be however that, before making it compulsory for all Member States, a review of the text should be made: it is not certain, for instance, that targeting “current economic, political or religious topics” remains as relevant now as it was when the text of the Berne Convention on this exception was adopted.

## Bibliography

BARABASH, I., "Ancillary copyright for publishers: the end of search engines and news aggregators in Germany?", *EIPR*, 2031, issue 5, p. 243 – 245;

BECHTOLD, T., in DREIER, T. & HUGENHOLTZ B., (eds), *Concise European Copyright Law*, Kluwer, The Netherlands, 2006;

BUYDENS, M., « La nouvelle directive du 22 mai 2001 sur l'harmonisation de certains aspects du droit d'auteur et des droits voisins dans la société de l'information: le régime des exceptions », *A&M*, 4/2001, p. 438 ;

COSTES, L., « Accord à l'arraché entre Google et les éditeurs de presse français », *Lamy*, 2013/90, p. 97 ;

d'atteinte au droit d'auteur sur Internet », *RDTI*, 44/2011, p. 48 ;

DREIER, T. "Regulating competition by way of copyright limitations and exceptions", in TORREMANS, P., *Copyright Law. A handbook of contemporary research*, Edward Elgar, U.S.A., 2007;

DREIER, T. in DREIER, T. & HUGENHOLTZ B., (eds), "Concise European Copyright Law", Kluwer, The Netherlands, 2006;

DUSOLLIER, S., « L'encadrement des exceptions au droit d'auteur par le test des trois étapes », *IRDI*, 2005 ;

DUSOLLIER, S., *Scoping study on copyright and related rights and the public domain*, WIPO, 2010, p. 32, at [http://www.wipo.int/edocs/mdocs/mdocs/en/cdip\\_4/cdip\\_4\\_3\\_rev\\_study\\_inf\\_1.doc](http://www.wipo.int/edocs/mdocs/mdocs/en/cdip_4/cdip_4_3_rev_study_inf_1.doc) ;

ERCOLANI, S., in LINDNER, B., and SHAPIRO T., *Copyright in the Information Society. A guide to national implementation of the European directive*, Edward Elgar, UK and USA, 2011;

GOLDSTEIN, P & B. HUGENHOLTZ, *International Copyright*, Oxford University Press, Oxford, 2<sup>nd</sup> ed., 2010;

GUIBAULT, L. *et al.*, *Study on the implementation and effect in Member States' laws of Directive 2001/29/EC on the harmonisation of certain aspects of copyright and related rights in the information society*, IViR, Amsterdam, 2007;

GUIBAULT, L., "Dutch press exception revisited", *Kluwer Copyright Blog*, 9 August 2011, at <http://kluwercopyrightblog.com/2011/08/09/dutch-press-exception-revisited/>;

GUIBAULT, L., "The Press Exception in the Dutch Copyright Act", in HUGENHOLTZ, P.B., QUAEDVLIEG, A.A., & VISSER, D.J.G., (eds.), *A Century of Dutch Copyright Law. Auteurswet 1912-2012*, Amsterdam, 2012;

HUGENHOLTZ, B., "Chronicle of The Netherlands Dutch copyright law, 1990-1995", *RIDA*, 1996, p. 176 at <http://www.ivir.nl/publications/hugenholtz/PBHbk!.pdf> ;



HUGENHOLTZ, B., "Goodbye, Geschriftenbescherming!", 6 March 2013, at <http://kluwercopyrightblog.com/2013/03/06/goodbye-geschriftenbescherming/>;

HUGENHOLTZ, P. & SENFTLEBEN, R. F., *Fair use in Europe. in search of flexibilities*, IViR, Vrije Universiteit Amsterdam, Amsterdam, 2011;

ISELL, K., "The rise of the news aggregators", 30 August 2010, [http://cyber.law.harvard.edu/publications/2010/news\\_aggregator\\_legal\\_implications\\_best\\_practices](http://cyber.law.harvard.edu/publications/2010/news_aggregator_legal_implications_best_practices;);

JANSSENS, M.-C., in BRISON, F., & VANHEES, H. (eds.), *Hommage à Jan Corbet. La loi belge sur le droit d'auteur*, Larcier, Brussels, 3<sup>rd</sup> ed., 2012;

LEÓN, M. G., in LINDNER, B., and SHAPIRO T., *Copyright in the Information Society. A guide to national implementation of the European directive*, Edward Elgar, UK and USA, 2011;

LUCAS, A. & LUCAS, H.-J., , 3<sup>rd</sup> ed., Paris, Litec, 2010 ;

MANHAEVE, K. and SCHILTZ, T., in LINDNER, B., and SHAPIRO T., *Copyright in the Information Society. A guide to national implementation of the European directive*, Edward Elgar, UK and USA, 2011;

MONTANARI, A., "Lex Google": Copyright Law and Internet Providers – Future Enemies or Allies", *EIPR*, 2013, issue 8, p. 433;

NEELS, L., "Copyright protection for press releases?", *EIPR*, 1992, n°4, p. 130;

PHÉLIP, O., "Google et la presse française: un accord de "raison"", 2 February 2013, at [http://www.huffingtonpost.fr/olivia-phelip/accord-google-presse\\_b\\_2613994.html](http://www.huffingtonpost.fr/olivia-phelip/accord-google-presse_b_2613994.html);

QUAEDVLIEG, A., « Les informations d'actualité en droit néerlandais », in LUCAS, A., SIRINELLI, P., & BENSAMOUN, A. (dir), *Les exceptions au droit d'auteur. Etat des lieux et perspectives dans l'Union européenne*, Dalloz, Paris, 2012;

QUAEDVLIEG, A.A., in LINDNER, B., and SHAPIRO T., *Copyright in the Information Society. A guide to national implementation of the European directive*, Edward Elgar, UK and USA, 2011, p. 414;

RICKETSON, S. & GINSBURG, J.C., *International Copyright and Neighbouring Rights. The Berne Convention and Beyond*, vol. I, Oxford University Press, New York, 2005;

SENFTLEBEN, M., *Copyright, limitations and the three-step test. An analysis of the three-step test in international and EC Copyright law*, Kluwer International, The Hague, London, New York, 2004;

SMITH, J. & MONTAGNON R., "The Supreme Court's opinion on browsing: Public Relations Consultants Association v. Newspaper Licensing Agency", *EIPR*, 2013/8, p. 478;

SPOOR, J., VERKADE, D., & VISSER, D., *Auteursrecht, naburige rechten en databankenrecht*, Kluwer, 3<sup>rd</sup> ed., 2011;

STANGANELLI, M., "Spreading the news online: a fine balance of copyright and freedom of expression in news aggregation", *EIPR*, 2012/11, p. 750;

TRIAILLE, J.P., "Copiepresse vs. Google", *RDTI*, 2007/1 ;

VOORHOOF, D., « Slecht nieuws voor Google News », *A&M*, 2007/1-2, p. 116;

WALTER, M. W. & VON LEWINSKI, S. (eds), *European Copyright Law. A commentary*, Oxford University Press, U.K., 2010;

WESTKAMP, G., "The new German publisher's right – a violation of European Law? A comment", *Queen Mary Jour.*, 2013, vol. 3, issue 3, p. 241-250;

XALABARDER, R., "Google News and Copyright", in LOPEZ-TARRUELLA, A. (ed.), *Google and the Law. Empirical approaches to legal aspects of knowledge-economy business models*, Springer, The Netherlands, 2012.

KM-01-13-039-EN-N

DOI : 10.2780/90141

ISBN : 978-92-29918-6